

HIGH-SPEED DATA (HSD) COMMUNICATION CONNECTORS

Data connection system based on
shielded star-quad (SSQ)

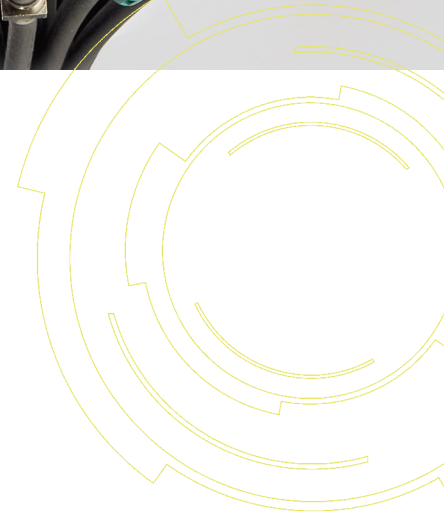

High-Speed Data (HSD) Communication Connectors

Data connection system based on shielded star-quad (SSQ)

TE Connectivity's (TE's) High Speed Data (HSD) portfolio is designed for high speed data transmission to meet automotive requirements up to 3Gbps. This highly robust and fully shielded system is designed to provide high-speed connectivity solutions for applications such as in-vehicle infotainment modules, cameras, consumer ports and display units.

TE's HSD is designed for differential data transmission that offers excellent Electromagnetic Interference (EMI) performance. EMI emissions are minimal from a differential pair, as compared to single ended systems, due to the positive and negative signals effectively canceling each other out. Similarly, incoming noise will effect both conductors equally, which can easily be removed by the receiver.

Applications

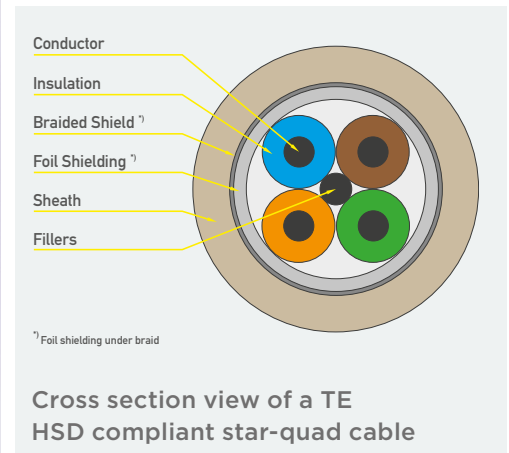
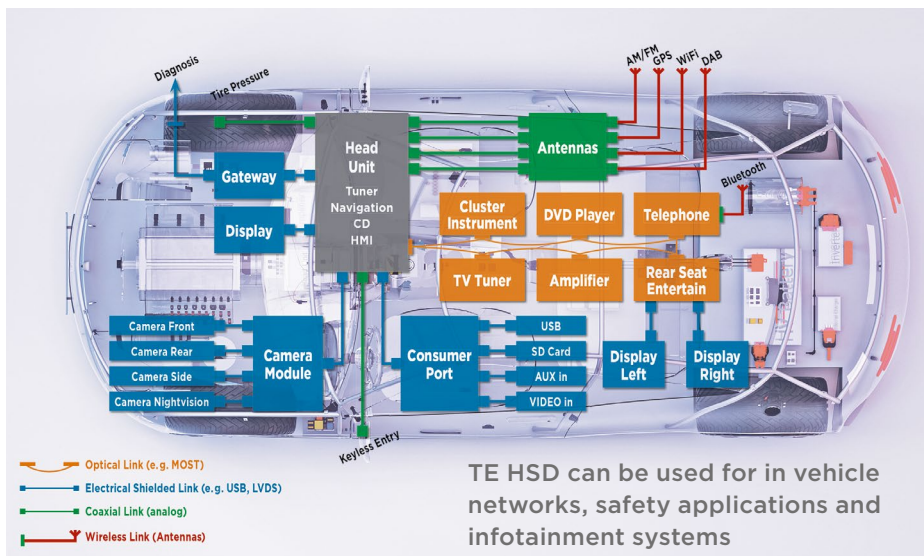

Key Features

- Full range of connectors for unsealed and sealed applications
- High level of process automation and global manufacturing footprint
- Compatible with the German AK HSD interface
- Validated with various types of shielded star-quad cables 4x0.14 mm², 4x0.22 mm², 4x0.5 mm²
- 0.8 μm Au surface in terminal mating area to meet automotive requirements
- Impedance optimized HF Design supported by stamped signal pin profiles

Mechanical Data

Mating Cycles	min. 25 (contact surface: gold)
Mating and Unmating Force	max. 30 N
Cable retention Force	min. 110 N
Polarization Feature Effectiveness	min. 80 N

Market Compatibility

- LVDS, Ethernet and USB protocols
- IEEE 1394 (Firewire)
- LV214
- USCAR 2, REV 5
- GVIF
- MOST

Electrical Data

Impedance 100 Ω +/- 15%





Shielding Attenuation

0-1GHz min. 70dB (Cable Assembly)
0-2 GHz min. 60dB (Cable Assembly)



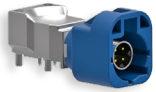



Current Capability

80°C min. 1.5A
according to HSD product specification
(Derating up to 3A tested as well)

HSD Header Portfolio

	Description	TE PN	Specifications
	Standard 90° Diecast Header	X-2286546-X	Product Specification 108-94479 108-94331 Application Specification 114-94381 114-18867
	90° + 2 MQS Diecast Header	X-2286550-X	
	90° Shielded Diecast Header	X-2286797-X	
	Standard 180° Diecast Header	X-2286547-X	

HSD Connector Portfolio

	Description	TE PN	Specifications		Description	TE PN	Specifications
Standard		X-1823898-X	Product Specification 108-94334 Application Specification 114-94117	Dual		X-2236886-X	Product Specification 108-94433 Application Specification 114-94117
		X-1823905-X				X-2236891-X	
		X-2208145-X	Product Specification 108-94333 Application Specification 114-94058			X-2236888-X	
Standard Sealed		X-1823853-X	Product Specification 108-94334 Application Specification 114-94117	Hybrids* (HSD + MQS)		X-2177694-X	
		X-1823857-X				X-2177954-X	
		X-2324148-X				X-2236326-X	

Interface according to HSD Interface Drawing 114-18950

*Contact TE for more HSD +MQS combinations

Coding Standard UP								Side view
	A	B	C	D	E	F	Z	
Pre- / Suffix	0-xxxxxxx-1	0-xxxxxxx-2	0-xxxxxxx-3	0-xxxxxxx-4	0-xxxxxxx-5	0-xxxxxxx-6	0-xxxxxxx-9	
Color	Jet Black	Cream	Signal Blue	Claret Violet	Leaf Green	Nut Brown	Water Blue	

Coding Standard DOWN								Side view
	G	H	J	K	L	M	O	
Pre- / Suffix	1-xxxxxxx-1	1-xxxxxxx-2	1-xxxxxxx-3	1-xxxxxxx-4	1-xxxxxxx-5	1-xxxxxxx-6	1-xxxxxxx-9	
Color	Blue Gray	Heather Violet	Beige	Curry	Yellow Green	Pastel Orange	Light Green	

Coding REVERSE								Side view
	A	B	C	D	E	F	Z	
Pre- / Suffix	2-xxxxxxx-1	2-xxxxxxx-2	2-xxxxxxx-3	2-xxxxxxx-4	2-xxxxxxx-5	2-xxxxxxx-6	2-xxxxxxx-9	
Color	Jet Black	Creme	Signal Blue	Claret Violet	Leaf Green	Nut Brown	Water Blue	

For further information please contact:

Lilian Wan
Product Manager HSD
Email: lilian.wan@te.com

Nikhil Kakanavaram
Field Application Engineer
Electrical Components
Email: nikhil.kakanavaram@te.com

TE Connectivity
2901 Fulling Mill Road
Middletown, PA 17057 USA

Product Information Center:
Phone: +1 800-522-6752
Fax: +1 717-986-7575

www.TE.com

© 2019 TE Connectivity | All rights reserved.

TE, TE Connectivity, and TE connectivity (logo) are trademarks.
IEEE, USCAR, GVIF, and MOST are trademarks.
Other logos, product(s) and/or company names might be trademarks of their respective owners.

While TE Connectivity (TE) has made every reasonable effort to ensure the accuracy of the information in this catalog, TE does not guarantee that it is error-free, nor does TE make any other representation, warranty or guarantee that the information is accurate, correct, reliable or current. TE reserves the right to make any adjustments to the information contained herein at any time without notice. TE expressly disclaims all implied warranties regarding the information contained herein, including, but not limited to, any implied warranties of merchantability or fitness for a particular purpose. The specifications in this catalog are for reference purposes only and are subject to change without notice. Consult TE for the latest dimensions and design specifications.

1-1773982-3 | USL | Published 09-2019

