



SERVO MOTOR & SERVO DRIVE

INNOVATIVE INTERCONNECT
SOLUTIONS FOR AUTOMATION

EVERY CONNECTION COUNTS

LET'S CREATE THE CONNECTIONS THAT COUNT



TE Connectivity (NYSE : TE L) is a \$13 billion world leader in connectivity. The company designs and manufactures products at the heart of electronic connections for the world's leading industries including automotive, energy and industrial, broadband communications, consumer devices, healthcare, and aerospace and defense. TE Connectivity's long-standing commitment to innovation and engineering excellence helps its customers solve the needs for more energy efficiency, always-on communications and ever increasing productivity. With nearly 90,000 employees in over 50 countries, TE Connectivity makes connections the world relies on to work flawlessly every day.

To connect with the company, visit: www.TE.com.

EVERY VISION IS MORE THAN JUST A COLLECTION OF GOOD IDEAS.

Welcome to Automation & Control. TE Connectivity is a major player in plant and mechanical engineering and industrial automation. We have been maintaining partnerships with leading companies in the automation industry in key markets such as Germany, Japan, the United States and China for around six decades.

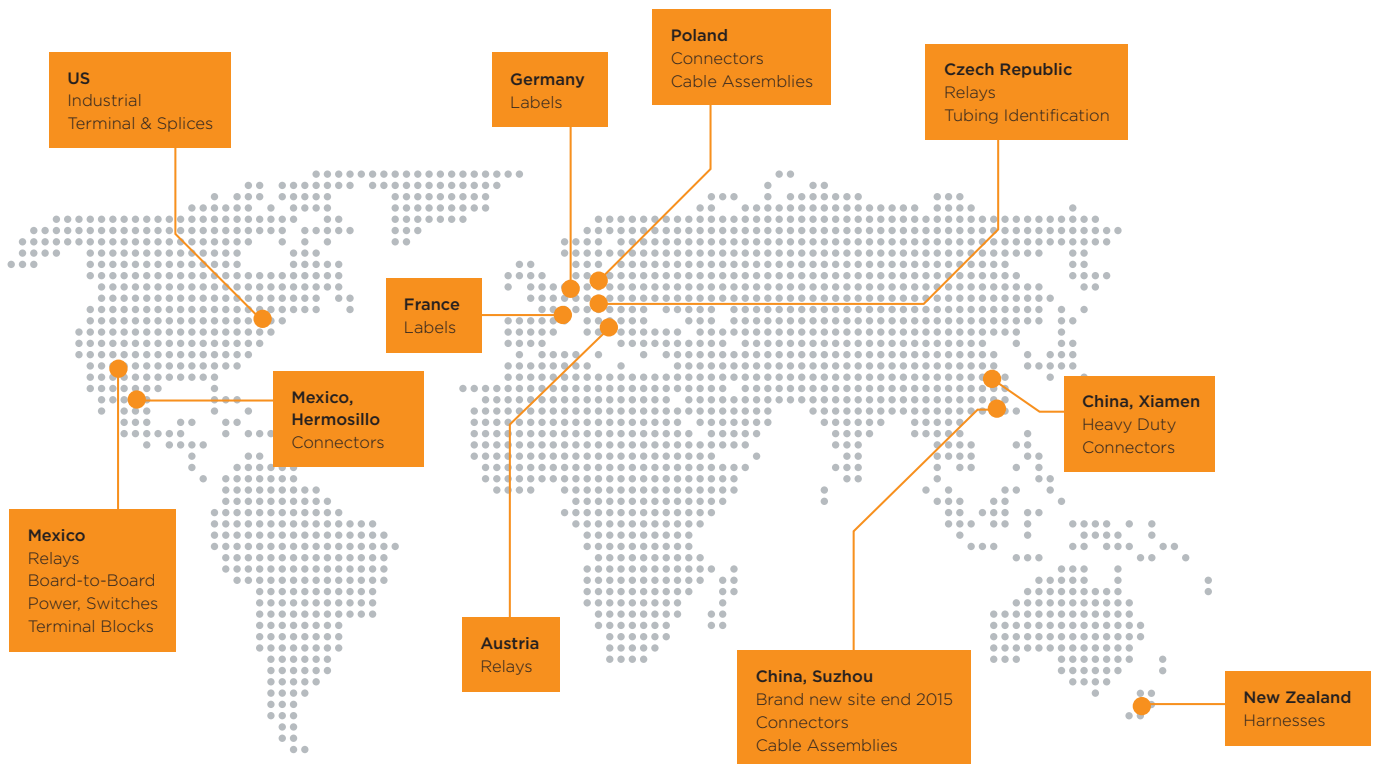

TE Connectivity worldwide — our production sites

COUNT ON TE. FROM DESIGN TO DELIVERY TO WHAT COMES NEXT.

Industrial production is increasingly driven by higher automation. By improved safety. By greater energy efficiency. You can count on TE to work with you every step of the way to develop solutions for every aspect of your production processes.

TE designs and manufactures products and solutions that connect and protect the flow of power, data and signal — in every aspect of our lives. We enable smarter, faster, better technologies to connect materials to end products — for all areas of life. This has made us a globally successful company — a world leader in automation and control technology. When it comes to ensuring the perfect solution, we meet every challenge.

COUNT ON PRODUCTS THAT HELP YOU COMPETE.

Our broad electromechanical and electronic product portfolio covers all your needs, ranging from simple machinery equipment to fully integrated factory automation and process solutions. For applications in a wide variety of production environments — and always extremely close to the needs of our customers from a wide range of sectors.

With TE as your innovation partner, you'll find everything you need to create and operate a cost-efficient and highly reliable production process. We are at our best when we work with your early design product & process management teams to get the job done right from the start. We also offer continuous improvement programs that give you a real competitive advantage. Because you can't achieve greater productivity and efficiency without better connectivity.

SMART TECHNOLOGY FOR TODAY AND TOMORROW.

Every vision starts with a big idea — and the absolute desire to face new challenges, develop new solutions and pursue new approaches. Our mission is to provide support for problem solvers in pursuing these approaches throughout the world. Working together to develop outstanding visions from big ideas — for innovations that make our world better.

THE TE 4.0 MANIFESTO

01.

IDENTIFYING OPPORTUNITIES:
FOR PERFECT INTEGRATION — AS EVERY CONNECTION COUNTS

02.

TAKING UP CHALLENGES:
A NEW GENERATION OF PRODUCTS —
FOR A NEW GENERATION OF CUSTOMER NEEDS.

03.

CREATING SOLUTIONS:
YOU CAN RELY ON TE — AND ON INTERCONNECT SOLUTIONS THAT MEET THE CHALLENGES OF TOMORROW TODAY.

04.

TURNING AIMS INTO REALITY:
GREATER PRODUCTIVITY, GREATER EFFICIENCY AND GREATER COST-EFFECTIVENESS — FOR YOU, YOUR CUSTOMERS AND A SMARTER WORLD.

INDUSTRY 4.0 — THE NEXT INDUSTRIAL REVOLUTION.

The rising levels of automation and decentralization of industrial production present major challenges. Now more than ever, automation solutions need to impress with their profitability — through long operating times, optimized energy efficiency and lower costs.

Industrial production needs to improve in every aspect — both now and in the future — with increased reliability, flexibility, adaptability and decentralization, more automation and smarter connections. TE Connectivity offers innovative solutions for enhanced connectivity. From the PCB level to the production line, in the toughest production conditions, anywhere in the world.

CONNECTIONS FOR A NEW GENERATION.

Digital technologies of today are key to the factories of tomorrow. These next-generation plants will be at the forefront of technological development and perfectly integrate and network the Internet, high-tech tools, employees and systems.

Our engineers here at TE are pioneers of this revolution — we are using our innovations to play a key role in turning the next level of industrial production into reality even faster.

SOLUTIONS FOR AUTOMATION.

“WE ARE A SMALL PART OF YOUR BIG IDEAS, AS BETTER AUTOMATION
IS FOUNDED ON BETTER CONNECTIONS.”

Gijs Werner, Strategic Marketing at TE Connectivity

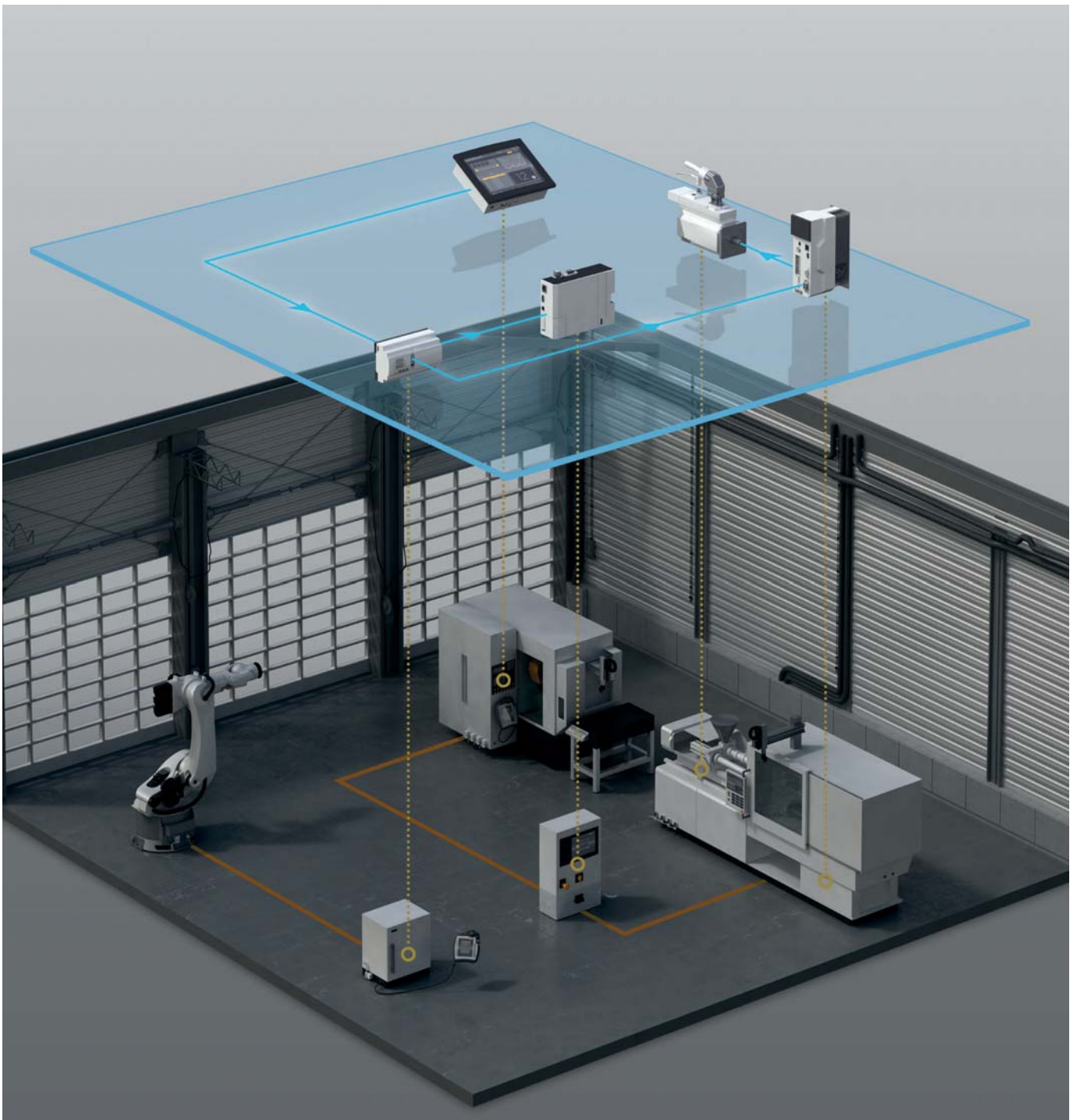

SERVO MOTORS AND SERVO DRIVES. TE DELIVERS GREATER FLEXIBILITY AND RELIABILITY FOR YOUR CUSTOMERS.

The demand for ecological, efficient and flexible production systems in a globalized and industrialized world is also advancing the development of servo motors and servo drives. We at TE Connectivity ensure that you are always able to meet your customers' growing requirements — thanks to servo technology that combines compact design, flexibility and reliability with very impressive results.

COMPACT TECHNOLOGY FOR AUTOMATION THAT ALSO MEETS YOUR FUTURE NEEDS. YOU CAN RELY ON TE.

Automation solutions are already standard in many industrial sectors. The automotive, packaging and textile industries are just some of the sectors where automated production plants controlled by servo technology are boosting productivity and cost-efficiency. Further advances can only be achieved through even faster and more precise feedback and control processes — made possible through the interaction of servo motors and servo drives.

Motors today are becoming increasingly compact but are housing an ever greater range of functions. Given the increased volume of data involved in communication with the drive, it is essential to have absolutely reliable connections that operate at the highest possible speeds. What's more, the numerous internal data and power interfaces need to be connected quickly, reliably and efficiently.

Our solutions are focused precisely on meeting these conditions for cutting-edge production — after all, every individual connection is important.

PROVEN INDUSTRY STANDARDS FORM THE BASIS FOR INNOVATION AT TE.

At TE we understand the special challenges facing the market. We know your customers' requirements and needs and the importance of constant innovation.

To provide you and your customers with the best possible support, we use next-generation technologies to develop future-proof products — we work in tandem with you in making servo technologies even more reliable, efficient and cost-effective. We are committed to growing your success — with reliable connectors that also give you maximum freedom in designing applications.

PRODUCT OVERVIEW.

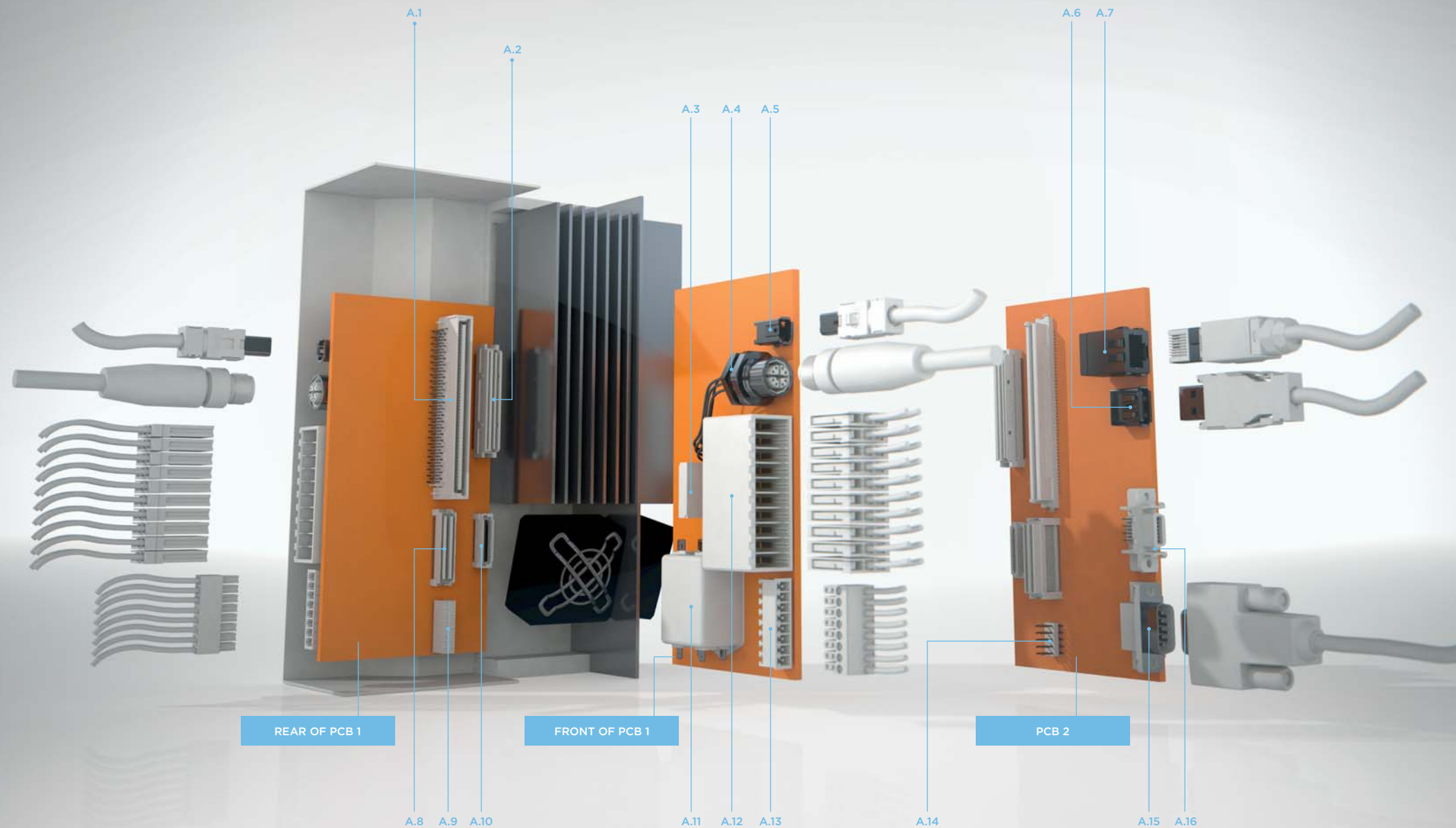

A. PRODUCTS

- A.1 1.27 MM INDUSTRIAL EXPRESS
- A.2 0.60 MM Z-STACK
- A.3 INDUSTRIAL RELAYS
- A.4 M12-X-CODE CONNECTORS
- A.5 MINI I/O CONNECTORS
- A.6 INDUSTRIAL USB CONNECTORS
- A.7 INDUSTRIAL RJ45 CONNECTORS
- A.8 0.60 MM MICRO-STACK CONNECTORS
- A.9 2.54 MM AMPMODU CONNECTORS
- A.10 0.80 MM FREE HEIGHT
- A.11 EMI/RFI FILTER
- A.12 DYNAMIC SERIES CONNECTORS
- A.13 TERMINAL BLOCKS
- A.14 2.54 MM AMPMODU CONNECTORS
- A.15 D-SUB CONNECTORS
- A.16 CHAMP CONNECTORS

B. SERVO MOTOR 1

- B.1 MOTORMAN HYBRID CONNECTORS
- B.2 M8/M12 CONNECTOR SYSTEM
- B.3 RESOLVER

C. SERVO MOTOR 2

- C.1 MICRO MOTOR CONNECTORS
- C.2 RESOLVER

D. SERVO MOTOR 3

- D.1 CIRCULAR POWER & SIGNAL I/O CONNECTORS
- D.2 RESOLVER

E. SERVO MOTOR 4

- E.1 HDC RECTANGULAR
- E.2 HDC RECTANGULAR
- E.3 RESOLVER

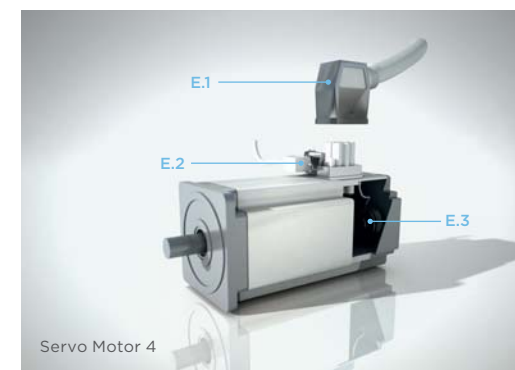
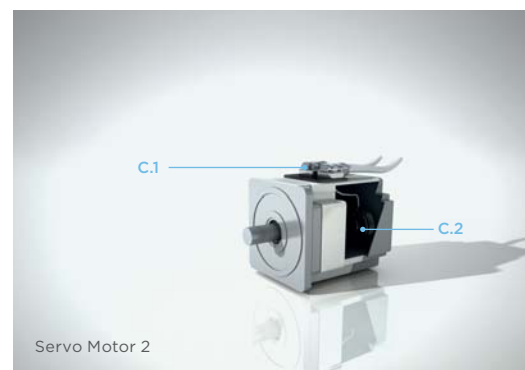
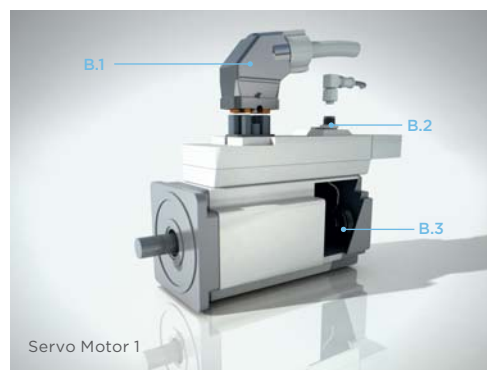

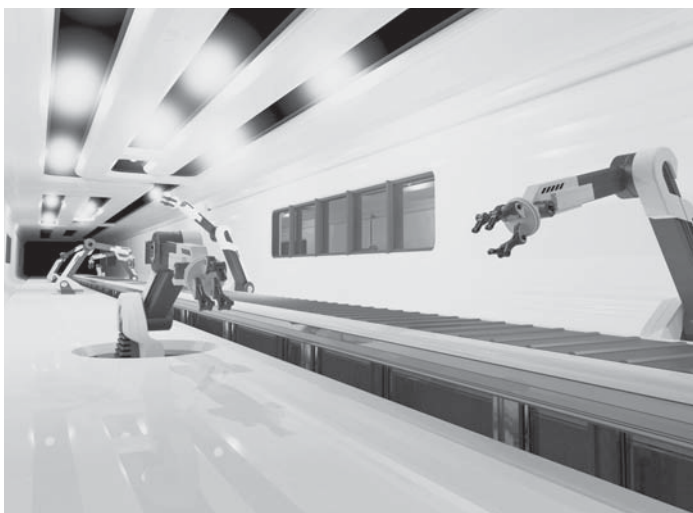

**LET'S CREATE SOMETHING
BRILLIANT TOGETHER**

WE ARE DRIVEN BY OUR WISH TO KEEP ON DEVELOPING. THAT'S WHY WE ARE CONSTANTLY WORKING ON INNOVATIVE INTERCONNECT PRODUCTS AND SYSTEMATICALLY IMPROVING EXISTING ONES. WE WORK IN TANDEM WITH YOU IN OVERCOMING EVERY CHALLENGE.

OUR FLEXIBLE SOLUTIONS FOR SERVO MOTORS AND SERVO DRIVES.

TE offers you a broad range of connectors for use in servo motors. For motors with integrated drives, the Motorman hybrid connector represents a space-saving hybrid interconnect solution. With its compact design, it enables integrated power, signal and communication transmission in just one connector and thus satisfies customer requirements for a whole range of production environments. This concept supports simple, fast and reliable installation. This is because a single hybrid interface also means there is only a single cable to be integrated.

Our Dynamic Series provides you with a whole family of ruggedized connectors. These reliable, easily-fitted connectors for a broad spectrum of cable thicknesses maximize productivity. Their three points of contact also ensure high electronic reliability — making sure you're already equipped for Industry 4.0.

AMPMODU CONNECTORS



The AMPMODU interconnect system is the proven TE solution and signal standard for Automation & Control applications. Designed to reliably and economically meet the packaging and interconnection requirements of today's industrial environments. It includes board-to-board, wire-to-board and wire-to-wire connectors. The large variety of components and application possibilities, combined with small size and outstanding quality, make the AMPMODU interconnect system ideal for many industrial applications and systems.

BENEFITS

- Unique modular concept, utilizing precision formed receptacle contacts and mating posts
- Different configuration possibilities offer design flexibility
- Economic and compact design allows for space saving

M8/M12 CONNECTOR SYSTEM



TE Connectivity's M8/M12 Connector System for machine industrial automation and control applications provides a solution that safely and reliably ensures communication in industrial environments. TE's solution includes an extensive connector range of receptacles, cable assemblies and IO boxes, and provides users with an interface that supports higher bandwidth needs meeting the requirements of up to 10 Gb/s.

TE's broad product portfolio provides customers with shielded and unshielded cable assembly options in both Cat5e and Cat6A cable types. For re-wiring on site, a range of field serviceable connectors are provided that include male and female versions in multiple positions and codings. Additional styles are available on request including alternative mounting arrangements for panel mount connectors and double ended cable assemblies.

BENEFITS

- Easily installable connector system reduces maintenance time
- M8/M12 Connector System provides full industry standard solution including quick turn, prototype cable assemblies

INDUSTRIAL MINI I/O CONNECTORS



TE's Industrial Mini I/O Field Installable connector provides innovative and time-saving wire-termination while also serving as a space-saving and reliable I/O solution for industrial environments. TE's Industrial Mini I/O connector is only one quarter the size of the conventional RJ45 plug and, as a result, provides space saving and the flexibility to use limited space on the PCB more effectively. Designed with two points of contact, this connector is built for the stringent demands of an industrial and high vibration environment, enabling increased productivity through a reliable connection. With its innovative piercing termination, the Mini I/O Field Installable version decreases the time usually needed to terminate the wires through soldering and, with an easy to use hand tool, field assembly in virtually any environment is now possible.

BENEFITS

- Less downtime and reliable connections due to better vibration resistance than RJ45
- Space saving of up to 75% and increased design flexibility
- Easy, field installable solution

TERMINAL BLOCKS

D-SUBMINIATURE CONNECTORS

INDUSTRIAL RJ45 CONNECTORS



TE's Terminal Blocks offer design engineers a reliable connector system with a variety of connection styles and range of centerlines. This solution is used for various data, signal and power applications. This offering provides class leading quality and many different design opportunities.

BENEFITS

- Mates with industry standard headers on the same centerline spacing
- Fast wire connections
- Custom solutions available

TE Connectivity, the industry leader in D-Subminiature solutions, provides a complete range of quality, time-tested D-Sub connectors that have become the standard in the D-Sub industry. Our complete line of D-Subminiature connectors ranges from Right Angle and Vertical Posted connectors and Cable connectors to the AMPLIMITE .050 Series D-Sub connectors — for any complex application.

BENEFITS

- Cable and PCB mounted D-Sub connectors
- PCB mounted D-Subminiature connectors available in either right-angle or straight configurations
- Stacked headers reduce overall total header volume by 48% and PC board area by 38%

TE's Industrial Ethernet RJ45 connectors offer a ruggedized design for use in Industrial Ethernet applications and are equipped with a robust and fast termination technology, utilizing the company's common core design in the RJ45 Modular Plug Series. This solution can be applied in the field without the need for any tools. It significantly reduces installation time and costs. It is used in all of TE's field installable connector series, including IP20, ODVA and push-pull connectors. The Variant 14 push-pull connector is available in a plastic or metal shell, and with its robust termination technology allows fast and flexible field installation that withstands harsher industrial environments such as shock, vibration or temperature.

BENEFITS

- Field-installable modular plugs
- Easy and tool-less installation
- Ruggedized design for use in Industrial Ethernet applications

MOTORMAN HYBRID CONNECTOR

DYNAMIC SERIES CONNECTORS

RESOLVERS

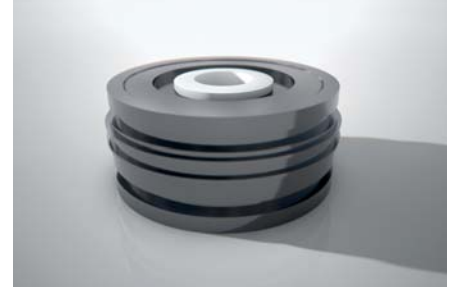

The fully configurable Motorman connectivity solution integrates communication, signals and power for real-time control at higher performance and half the size of current standards. The innovative design and compact size of the Motorman hybrid connector allows for significant space savings in comparison with traditional rectangular industrial connectors. It also helps to keep costs to a minimum by reducing the amount of overall cabling needed as well as shortening cable length.

BENEFITS

- Spacious side access to the inside assists easy and safe configuration
- Robust contact system to help minimize effects of impact and vibration
- Integration of power, signals and communication in compact design offers considerable space saving

Dynamic Series is a broad product family that provides connector solutions ranging from signal level circuitry through power circuit connectivity in a ruggedized, industrialized package. The connector family is designed for use in control system applications and is suitable for a wide range of applications requiring high density, signal and power applications.

Dynamic Series consists of wire-to-board, wire-to-panel and wire-to-wire connectors with diverse housings available to meet most applications. Standard crimp and spring clamp variations of parts are available. The standardized contacts limit the amount of application tooling required.

BENEFITS

- Easy mating and unmating for reduced installation and maintenance time
- Three points of contact provide high electrical reliability
- Reliable and safe connections for increased productivity

As automation progresses, there is also a steady increase in the use of sensors for determining angles. Resolvers can be found in many modern, high-precision control systems across multiple industries. TE's resolver portfolio offers low space requirements with high reliability even under harsh environmental conditions.

BENEFITS

- High rotational speed
- Shock and vibration resistant
- Very high signal-noise ratio

CABLE SERVICES FROM A SINGLE SOURCE — TE CONNECTIVITY MEETS ALL YOUR NEEDS.

TE Cable Assemblies takes care of its customers, with total solutions that fit precise needs. With our decades of experience, global expertise in development and manufacturing and worldwide network of competence centers, TE Cable Assemblies creates customized solutions and standardized products that work exactly as they should — to ensure high performance and cost-efficiency in any operation. Our cumulative experience is formidable — and we never forget that every customer, and every project, is unique.

WE DELIVER FAST:

FAST RESPONSE &
IMMEDIATE AVAILABILITY

WE FOCUS ON SOLUTIONS:

FLEXIBLE & EXPERIENCED

WE SAVE YOUR TIME:

FAST & ON SCHEDULE

WE PROVIDE SECURITY:

PROVEN RELIABILITY & HIGH QUALITY

WE WORK SEAMLESSLY:

SMOOTH EXECUTION &
CONSTANT COMMUNICATION

WE COMBINE POWER WITH FLEXIBILITY.

TE Cable Assemblies is on hand to identify our customers' needs and objectives, map out the issues that need resolving, and quickly take all the steps necessary to move from design into production.

To provide fully integrated solutions, TE engineers in cable assemblies development work hand in hand with development teams dedicated to connectors — our engineering teams can leverage our vast portfolio of connectors to make sure any solution provides a perfect fit for a customer's needs. And when it comes to creating the assemblies themselves, numerous automatic and semi-automatic manufacturing technologies are at our disposal — cutting & stripping, soldering, IDC insulation displacement, over-molding, and more.

TE Cable Assemblies' manufacturing footprint is global too — wherever you are, we are well placed to respond to your needs in terms of flexibility, reliability, and lead times.

WE MAKE SURE OUR HIGH STANDARDS NEVER SLIP.

Quality control is completely integrated throughout all our global manufacturing facilities. Furthermore, we apply the TE Operating Advantage (TEOA) — an enterprise-wide focus on business performance and continual improvement through waste elimination and deployment of best practices.

To meet numerous challenges all the way from concept to commercial product, we deploy processes such as Lean Product Development while dedicated project managers take care of your needs and potential issues. If a problem occurs, we will fix it.

LET'S CONNECT

We make it easy to connect with our experts and are ready to provide all the support you need. Just call your local support number or visit www.te.com/industrial to chat with a Product Information Specialist.

TECHNICAL SUPPORT

te.com/support-center

Australia	+86 400 8206015	Hungary	+36 1 2892040	Portugal	+34 91 6630420
Austria	+43 1 90560	India	+86 400 8206015	Russia	+74 95 7907902200
Belgium	+31 73 6246999	Ireland	+1 800 882391	Slovakia	+42 02 7201102
Brazil	+55 11 21036000	Italy	+39 011 4012111	Slovenia	+38 615 602132
China	+86 400 8206015	Japan	+044 844 8052	South Africa	+97 150 4570806
Czech Republic	+42 02 72011103	Korea	+02 3415 4607	Spain	+34 932 910330
Denmark	+46 8 50725000	Latvia	+37 2 6778673	Sweden	+46 8 50725000
Estonia	+37 2677 8673	Lithuania	+37 037426900	Switzerland	+41 71 4470447
Finland	+46 8 50725000	Luxembourg	+31 73 6246999	Taiwan	+86 400 8206015
France	+33 1 34208686	Netherlands	+31 73 6246999	Turkey	+90 212 2826053
Germany	+49 6151 6071999	New Zealand	+86 400 8206015	United Kingdom	+44 0800 267666
Greece	+97 1 43470226	Norway	+46 8 50725000	United States of America	+1 800 5226752
Holland	+31 73 6246999	Poland	+48 22 4576750		

te.com

TE Connectivity, TE Connectivity (logo), AMPLIMITE, AMPMODU, CHAMP, Dynamic, Mini I/O, Motorman, Z-STACK and Every Connection Counts are trademarks. All other logos, products and/or company names referred to herein might be trademarks of their respective owners.

The information given herein, including drawings, illustrations and schematics which are intended for illustration purposes only, is believed to be reliable. However, TE Connectivity makes no warranties as to its accuracy or completeness and disclaims any liability in connection with its use. TE Connectivity's obligations shall only be as set forth in TE Connectivity's Standard Terms and Conditions of Sale for this product and in no case will TE Connectivity be liable for any incidental, indirect or consequential damages arising out of the sale, resale, use or misuse of the product. Users of TE Connectivity products should make their own evaluation to determine the suitability of each such product for the specific application.

© 2014 TE Connectivity Ltd. family of companies All Rights Reserved.

1-1773847-8 11/14 wsp design

BROCHURE

TE Connectivity
Industrial Solutions
Pfnorstraße 1
64293 Darmstadt
Germany

Phone +49 6151 71696
te.com