

ENERGY PRODUCTS CATALOGUE

For Southeast Asia, Korea & Japan

GRID CONNECTIVITY + RELIABILITY

You're faced with daily challenges, like unforgiving environments, installation accuracy, constantly evolving technology, and animal-induced outages. We're ready to help. With over 60 years of electrical engineering experience and a global workforce dedicated to the Energy industry on a local level, we know how to make every connection count across the energy landscape.

+ EQUALS MORE

We're with you every step of the way to keep the backbone of your grid connected, from generation to transmission to distribution to wherever energy is needed.

Comprehensive solutions and services from a single partner:

- Cable Accessories
- Connectors & Fittings
- Insulation & Protection
- Metering
- Installation Training

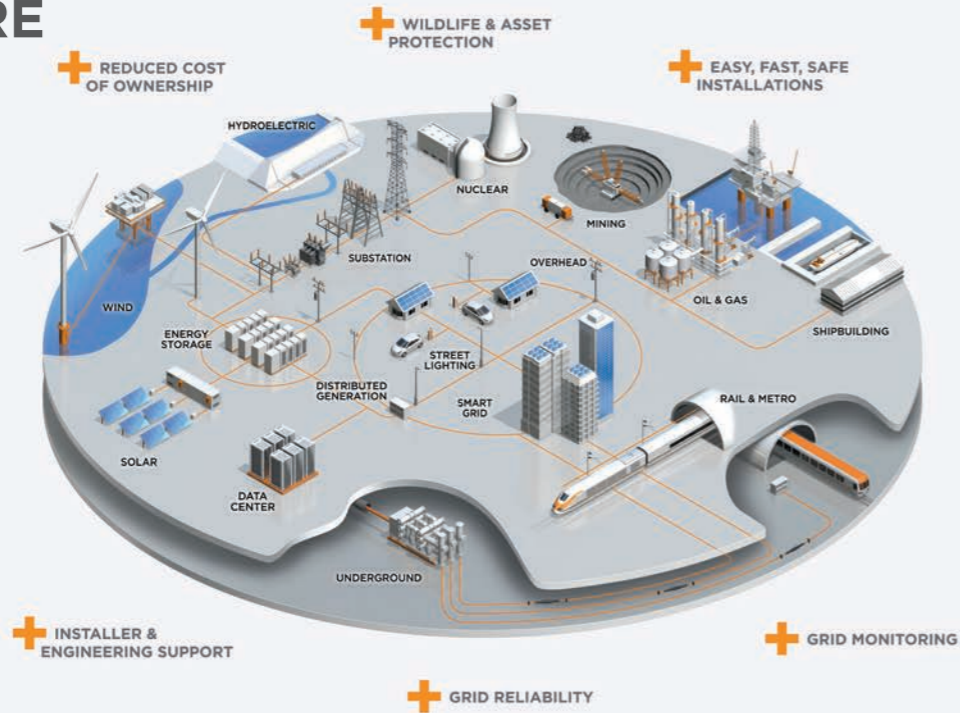

INNOVATION + COLLABORATION

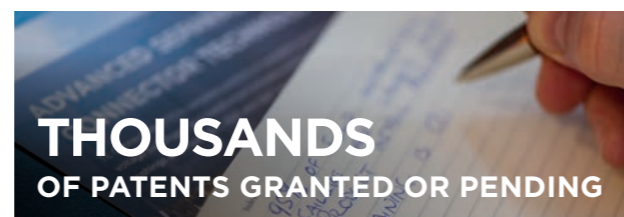

WE ARE THE BRANDS YOU RELY ON

Our experience is built on the foundation of industry-leading quality brands, so if you know Raychem, you know TE Connectivity. We are the inventors of heat shrink technology, and we have nearly three decades of proven performance in cold-applied technologies.

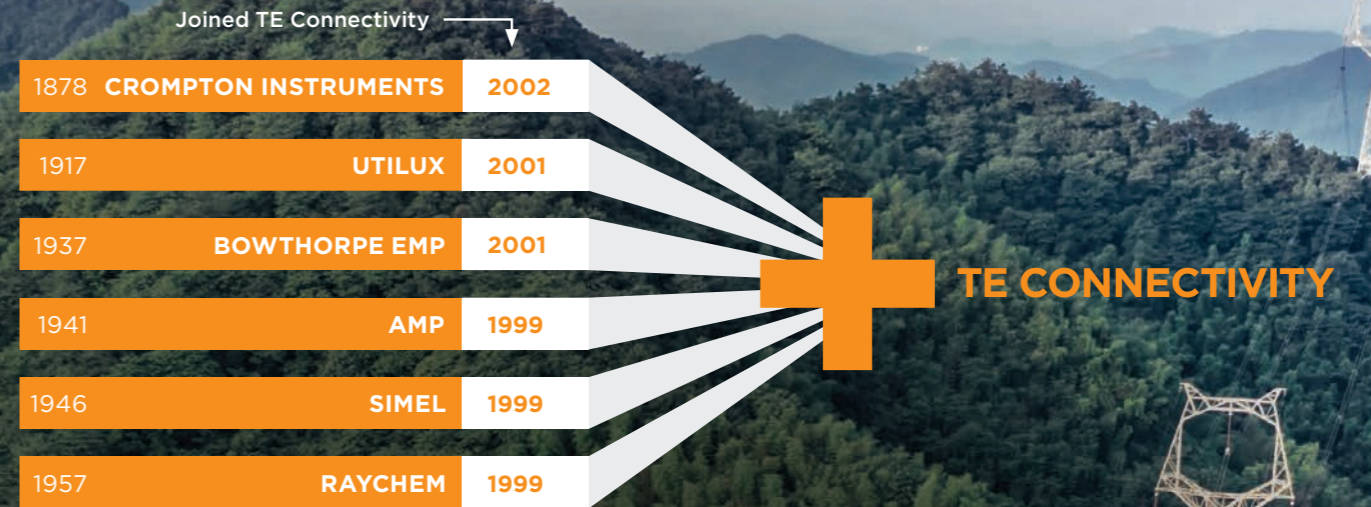

EXTREMES + RELIABILITY

Frigid winters. Intense sun. Salinity. Conditions might get tough, but the power needs to stay on. That's why we are relentlessly dedicated to materials science and testing in our labs to deliver built-in reliability. You can trust our products to perform even in harsh environments, and to help protect your assets for their service lifetime.

MATERIAL INNOVATION

UV Stable Materials	Non-Tracking Materials	UHV Composite Materials	Hydrophobic/Non-Wetting Materials	Advanced Conductive Materials	Cold Shrink Joints
Surge Suppression Systems	Resin Compound Materials	Insulating Power Gel	Shear Bolt Connectors	Heat Shrink Tubing	Cross-linking



INSTALLING EXCELLENCE IN ENERGY NETWORKS

The right products alone don't ensure grid reliability. Correct installation is a key factor that determines long-term product performance and grid reliability. Network outages are a costly disruption and they can be prevented with proper training.



50%+
Failures of medium voltage cable accessories are caused by installation errors

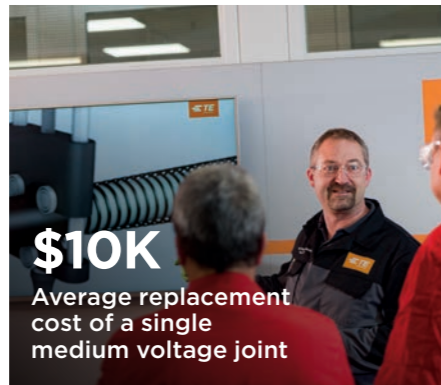

\$10K
Average replacement cost of a single medium voltage joint



2500
Installers trained globally every year by TE

GLOBAL TRAINING EXPERTISE

Our training programs help installers realize the full potential of our reliable technology and serve as a valuable asset to your team – and to your network. We provide comprehensive product training from low, medium and high voltage cable accessories, to wildlife and asset protection products. We also offer customized programs for different applications: Underground, Overhead, Substation, Renewable Energy, Nuclear Power, Mining, Rail, Shipbuilding & Offshore.

Give your installers access to decades of expertise with customized programs that combine high-quality course content with practical, in-field applications.

AT OUR TRAINING CENTERS

- Modern locations around the world (USA, Germany, France, Russia, China)
- Training and assessment of your trainers
- Instruction from our Field Service Technicians, Product Managers and Electrical Engineering Experts

AT YOUR JOB SITE OR FACILITY

- Real-time failure investigation in the field
- Cost-effective refresher courses
- Training and assessment in familiar environments

AT OUR DISTRIBUTOR LOCATIONS

- Customized training events at distributor locations
- Dedicated training capabilities through selected partners

TRAINING COVERS A WIDE RANGE OF PRACTICAL TOPICS:

- Cable Construction
- Cable Preparation & Tips
- Modern Tools & Techniques
- Important Installation Considerations

TO SCHEDULE AN INFORMATION SESSION OR LEARN MORE:

Visit [TE.com/trainingcenter](https://www.te.com/trainingcenter) or contact your local sales team or distribution partner.

GLOBAL TESTING FROM ACCREDITED LABORATORIES

RIGOROUS TESTING AND RUGGED PRODUCTS ARE OUR STANDARD

Our ISO-17025 accredited engineering laboratories perform critical electrical, mechanical, and environmental tests in accordance with international quality testing standards as listed below. We place a special focus on customer-related testing and as your testing partner, we can perform accredited testing in 20+ competencies for a broad range of products up to 245 kV, such as connectors, insulators, wildlife and asset protection and cable accessories.



TESTING STANDARDS

IEEE, ANSI, ASTM, CENELEC, NEMA, DIN, EN, IEC, NF, EATS

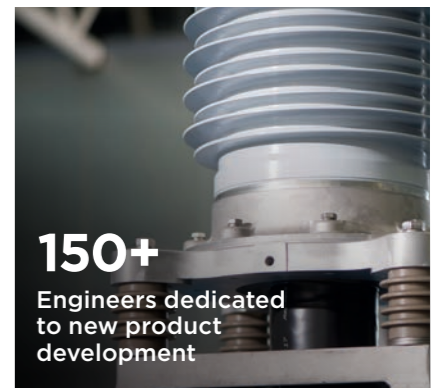

150+

Engineers dedicated to new product development

OUR TESTING INCLUDES:

- High Voltage Testing
- Short Circuit Testing
- Temperature Rise Testing
- Material Testing
- Artificial Pollution Testing
- Robustness Testing

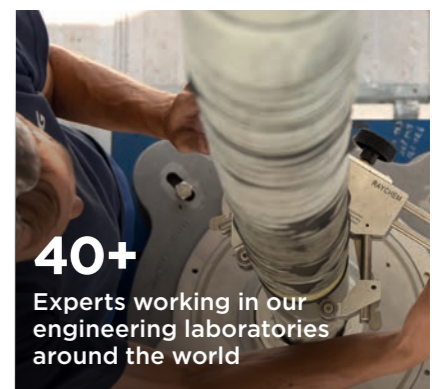
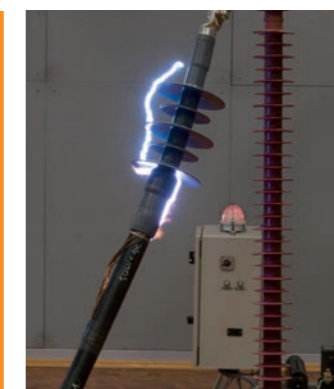

40+

Experts working in our engineering laboratories around the world

FOR MORE INFORMATION VISIT [TE.COM/ENERGY](https://www.te.com/energy)

Table of Contents

I. Low Voltage Cable Accessories



RDSS Duct Sealing System.....	12
Rayvolve RVS "Roll-on" Splices for 1/C Power Cable.....	14
End Caps.....	15
ZCSM Halogen-Free Heat Shrink Tubing.....	16
MWTM Medium Wall Heat Shrink Tubing.....	17
WCSM Thick Wall Heat Shrink Tubing.....	18
CRSM Wraparounds.....	19
EPKT Heat Shrink Terminations.....	20
EPKJ and AR Inline Joints.....	21
TSJ and TBJ Resin Filled Joints.....	22
GelWrap Water Resistant Wraparound Splice Closures.....	23
GILS Gel In-Line Water Resistant Splice Kit for Power Cable.....	24
GTAP Water Resistant Splices.....	25
GHFC Water Resistant H-Frame Closure for Power Cable.....	26
Gelport Submersible Connectors for URD Distribution.....	27
GelCap Water Resistant Stub Splice Covers.....	29
GelCap SL Water Resistant Splice Covers for Street Lights.....	30
Rayvolve RVC "Roll-on" Stub Connection Splice Cover Kits.....	31
Fuse Boxes for Street Lighting Applications.....	32

Low
Voltage
Cable
Accessories

II. Medium Voltage Cable Accessories

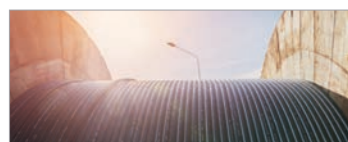

APKT Heat Shrink Terminations up to 36 kV.....	36
EPKT Heat Shrink Terminations up to 33 kV.....	39
IXSU/OXSU Heat Shrink Terminations up to 24 kV.....	43
EPKJ Heat Shrink Joints up to 36 kV.....	45
MXSU/MXST/MXSW/MXAW Heat Shrink Joints with Mechanical Connector up to 36 kV.....	49
SXSU/SXST/SXSW/SXAW Heat Shrink Joints for Polymeric Cables up to 36 kV.....	51
RICS Insulated Adapter Termination System up to 24 kV.....	53
RCAB Elastomeric Insulating Bushing Boots up to 24 kV.....	54
CSJT Cold Shrink Joints up to 36 kV.....	55
CSTI/CSTO Cold Shrink Terminations up to 24 kV.....	56
ELBC Screened Separable Connectors up to 24 kV.....	58
RSTI Screened Separable Connectors up to 36 kV.....	62
RSTI-CC Screened Coupling Connectors up to 36 kV.....	63
RSTI-SA Screened Connectors with Surge Arrester up to 36 kV.....	64
RSES 64xx Screened Adapter System up to 36 kV.....	65
RSES and RSSS-52XX Screen Adapter System up to 24 kV.....	66
RSRB Heat Shrink Bushing Boots up to 11 kV.....	67
RPIT Plug-in Terminations up to 42 kV.....	68
RSTF Separable Connectors up to 72,5 kV.....	69

Medium
Voltage
Cable
Accessories

III. High Voltage Cable Accessories



IHVT-H/OHVT-H/LHVT-H Heat Shrink Terminations.....	72
OHVT-HS Self Supporting Heat Shrink Terminations.....	73
DC Filter Cables FCEV.....	74
OHVT-C Outdoor Terminations Composite.....	75
OHVT-P Outdoor Terminations Porcelain.....	76
OHVT-D Outdoor Terminations Dry Type.....	77
OHVT-G Outdoor Terminations Gel Type.....	78
OHVT-F Dry Flexible Terminations.....	79
OHVT-FS Self Supporting Dry Flexible Terminations.....	80
Arcing Horn for Outdoor Terminations (OHVT).....	81
Lifting Device for Outdoor Terminations (OHVT).....	81
Grounding Kits.....	82
Fibre-Optic Add-On Kit.....	82
PHVS & PHVT Dry Plug-In Switchgear and Transformer Terminations.....	83
Add-On Kits for TE's Raychem Dry Plug-In Switchgear and Transformer PHVS and PHVT Terminations.....	84
EHVS Heat-Shrinkable Joints.....	86
EHVS-S One Piece Joints.....	87
One Piece Joints up to 145 kV.....	88
One Piece Joints up to 245 kV.....	89
EHVS-T Three Piece Joints.....	90
Three Piece Joints up to 145 kV.....	91
Three Piece Joints up to 170 kV.....	92
Fibre-Optic Add-On Kit for HV Cable Joints.....	93
Link Boxes.....	94
Most Popular Cable Sheath Grounding Options.....	95
EPPA-055-Link Boxes.....	99
Selection Tables for TE's Raychem Link Boxes for Single Core Cables.....	100

High
Voltage
Cable
Accessories

IV. Connectors & Fittings



AutoPress L62 Hydraulic Crimping Tool.....	104
Insulation Piercing Connectors.....	106
Shear Bolt Terminal Lugs and Connectors.....	107
Copper Lugs Longitudinally Sealed.....	110
Bimetallic Lugs for Aluminium Conductors.....	111
Copper Tubular Terminals and Splices.....	112
Waterproof Pre-insulated Mechanical Connectors.....	116
Anchor and Suspension Clamps for Service Cables.....	117
Anchor Clamps for Self Supporting LV-ABC Lines.....	118
Suspension Clamps for Self Supporting LV-ABC Lines.....	119
Anchor Clamps for LV-ABC Lines with Insulated Neutral Messenger.....	120
Shear Bolt Type Mechanical Connectors.....	121

Connectors
& Fittings

V. Wildlife & Asset Protection



BBIT / BPTM Busbar Insulating Tubing.....	126
HVBT High Voltage Busbar Insulating Tape.....	127
HVIS High Voltage Busbar Insulating Sheet.....	129
HVBC High Voltage Cable-to-Bus Insulation.....	130
HVCE High Voltage Creepage Extenders.....	131
HVCE-WA Wraparound High Voltage Creepage Extenders.....	132
MVLC Medium Voltage Line Covers.....	133
MVLC-Installation Tools for Overhead Conductors.....	134
MVCC Medium Voltage Conductor Covers.....	135
BCAC Distribution Covers for Animal Protection.....	136
BCAC Bushing Connection Animal Covers.....	137
BCAC-IC Bushing Connection Inspection Substation Covers.....	138
BCIC Bushing Connection Insulating Covers.....	139
BCIC Reclosers Covers.....	147
BCIC-115-PH Transmission Flashover Protection Covers.....	148
BCIC-AFD-01 Avian Flight Diverters.....	148
BCIC Birdcap Protection Covers.....	149
BISG / BISG-24 Bus Isolation Squirrel Guards.....	151
MVFT Medium Voltage Fusion Tape.....	152
LVIT Busbar Insulating Tubing (1000 V).....	153
HVBS High Voltage Booster Sheds.....	154
RRGS Polymeric and Porcelain Rigid Red Guano Shields.....	154
LVBT Low Voltage Busbar Insulating Heat Shrink Tape.....	155

Wildlife
and Asset
Protection

VI. Insulators



RLP F-Neck EVA Line Post Insulators	159
RLP Vertical Clamp EVA Line Post Insulators.....	160
RLP Horizontal Clamp EVA Line Post Insulators.....	161
CLP Silicone Line Post Insulators.....	162
RST, EVA Suspension Tension Insulators.....	164
CS Silicone Suspension Tension Insulators	165
EPBI, EVA Standoff Insulators.....	167
RAP, EVA Polymeric Station Post Insulators.....	168
HSHI-RAYBOWL Hybrid Line Post Insulators.....	169
Porcelain Disc Insulators.....	170
Porcelain Station Post Insulators.....	173

Insulators

VII. Surge Arresters



LV Surge Arresters.....	178
DOV Medium Voltage Surge Arresters.....	180
OCP Open Cage Polymeric Series.....	182
HDA Raychem Distribution Arresters.....	185
CPA Surge Arresters for Cable Sheath Protection System.....	188
MPA Raychem MV Surge Arresters for Indoor Applications.....	189
SPA Raychem MV Surge Arresters for Indoor Applications.....	190
RDA Raychem MV Surge Arresters for Indoor Applications.....	191
MCA/MDA HV Single Column Porcelain Surge Arresters.....	192
HV Single Column Polymeric Surge Arresters.....	198
TLA HV Transmission Line Surge Arresters.....	202

Surge
Arresters

VIII. Crompton Instruments



Crompton
Instruments



Chapter I Low Voltage Cable Accessories

RDSS Duct Sealing System	12
Rayvolve RVS “Roll-on” Splices for 1/C Power Cable.....	14
End Caps	15
ZCSM Halogen-Free Heat Shrink Tubing	16
MWTM Medium Wall Heat Shrink Tubing	17
WCSM Thick Wall Heat Shrink Tubing	18
CRSM Wraparounds.....	19
EPKT Heat Shrink Terminations.....	20
EPKJ and AR Inline Joints	21
TSJ and TBJ Resin Filled Joints	22
GelWrap Water Resistant Wraparound Splice Closures	23
GILS Gel In-Line Water Resistant Splice Kit for Power Cable.....	24
GTAP Water Resistant Splices	25
GHFC Water Resistant H-Frame Closure for Power Cable	26
Gelport Submersible Connectors for URD Distribution.....	27
GelCap Water Resistant Stub Splice Covers	29
GelCap SL Water Resistant Splice Covers for Street Lights	30
Rayvolve RVC “Roll-on” Stub Connection Splice Cover Kits	31
Fuse Boxes for Street Lighting Applications.....	32

RDSS Duct Sealing System

FEATURES

- Consists of an inflatable, sealed bladder of flexible, metallic laminate material, which has pre-installed, high-temperature sealant strips on both sides.
- The bladder is first inflated to 45 psi (three-bar) internal pressure, and then presses the sealant against the duct wall and onto the substrate.
- The bag uses a self-sealing gel material to seal the filling hole when the filling tube is removed

APPLICATIONS

- Designed for use in conjunction with plastic, concrete, or steel ducts to provide a watertight duct seal.
- Seals cable ducts and helps to prevent flooding in cable vaults, access manholes, substation basements, and customer feeds. It can be installed while the water is flowing —see photograph.

BENEFITS

- For applications with three or more cables, an RDSS-CLIP is inserted between the cables.
- The RDSS-CLIP is a high-temperature mastic mounted on an installation stick. It seals the area between the cables when used in conjunction with the RDSS inflatable bladder.
- Acceptable to use on medium voltage cables including unjacketed concentric neutral

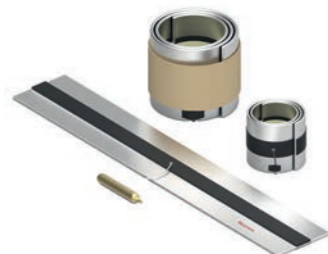

Duct Inner Diameter	Number of Cables in Duct/ Max Cable Bundle Diameter					
	0, 1, or 2 Cables		3 or 4 Cables		5, 6, 7 Cables	
1.25 (32)	RDSS-45	0.5 (13)	RDSS-45, 1 RDSS-CLIP-45	0.3 (8)	RDSS-45, 2 RDSS-CLIP-45	0.1 (3)
1.50 (38)	RDSS-45	1.0 (25)	RDSS-45, 1 RDSS-CLIP-45	0.8 (20)	RDSS-45, 2 RDSS-CLIP-45	0.6 (15)
1.75 (45)	RDSS-45	1.3 (32)	RDSS-45, 1 RDSS-CLIP-45	1.05 (27)	RDSS-45, 2 RDSS-CLIP-45	0.9 (22)
2.00 (50)	RDSS-60	1.2 (30)	RDSS-60, 1 RDSS-CLIP-75	1.0 (25)	RDSS-60, 2 RDSS-CLIP-75	0.8 (20)
2.25 (57)	RDSS-60	1.6 (41)	RDSS-75, 1 RDSS-CLIP-75	1.4 (36)	RDSS-75, 2 RDSS-CLIP-75	1.2 (31)
2.50 (64)	RDSS-75	1.5 (38)	RDSS-75, 1 RDSS-CLIP-75	1.3 (33)	RDSS-75, 2 RDSS-CLIP-75	1.1 (28)
2.75 (70)	RDSS-75	1.8 (46)	RDSS-75, 1 RDSS-CLIP-75	1.6 (41)	RDSS-75, 2 RDSS-CLIP-75	1.4 (36)
3.00 (75)	RDSS-75	2.2 (56)	RDSS-75, 1 RDSS-CLIP-75	2.0 (50)	RDSS-75, 2 RDSS-CLIP-75	1.8 (46)
3.25 (83)	RDSS-100	2.2 (56)	RDSS-100, 1 RDSS-CLIP-100	2.0 (50)	RDSS-100, 2 RDSS-CLIP-100	1.8 (46)
3.50 (89)	RDSS-100	2.6 (66)	RDSS-100, 1 RDSS-CLIP-100	2.4 (61)	RDSS-100, 2 RDSS-CLIP-100	2.2 (56)
3.75 (95)	RDSS-100	2.9 (74)	RDSS-100, 1 RDSS-CLIP-100	2.7 (69)	RDSS-100, 2 RDSS-CLIP-100	2.5 (64)
4.00 (100)	RDSS-100	3.2 (80)	RDSS-100, 1 RDSS-CLIP-100	3.0 (75)	RDSS-100, 2 RDSS-CLIP-100	2.8 (70)
4.25 (108)	RDSS-100	3.5 (89)	RDSS-100, 1 RDSS-CLIP-100	3.3 (85)	RDSS-100, 2 RDSS-CLIP-100	3.1 (79)
4.50 (114)	RDSS-100	3.5 (89)	RDSS-100, 1 RDSS-CLIP-100	3.3 (85)	RDSS-100, 2 RDSS-CLIP-100	3.1 (79)
4.75 (121)	RDSS-125	3.8 (97)	RDSS-125, 1 RDSS-CLIP-125	3.6 (92)	RDSS-125, 2 RDSS-CLIP-125	3.4 (87)
5.00 (125)	RDSS-125	4.1 (104)	RDSS-125, 1 RDSS-CLIP-125	3.9 (98)	RDSS-125, 2 RDSS-CLIP-125	3.7 (93)
5.25 (133)	RDSS-150†	4.3 (109)	RDSS-150†, 1 RDSS-CLIP-150	4.1 (104)	RDSS-150†, 2 RDSS-CLIP-150	3.9 (98)
5.50 (140)	RDSS-150†	4.7 (120)	RDSS-150†, 1 RDSS-CLIP-150	4.5 (114)	RDSS-150†, 2 RDSS-CLIP-150	4.3 (109)
5.75 (146)	RDSS-150†	4.9 (124)	RDSS-150†, 1 RDSS-CLIP-150	4.7 (119)	RDSS-150†, 2 RDSS-CLIP-150	4.5 (114)
6.00 (150)	RDSS-150†	5.1 (129)	RDSS-150†, 1 RDSS-CLIP-150	4.9 (124)	RDSS-150†, 2 RDSS-CLIP-150	4.7 (120)
6.25 (159)	RDSS-150†	5.4 (138)	RDSS-150†, 1 RDSS-CLIP-150	5.2 (133)	RDSS-150†, 2 RDSS-CLIP-150	5.0 (125)

6.50-8.00 (165-210) Ducts in this range require the use of RDSS-AD-210 adapter. Contact your TE representative for application information. See Ordering information.

ADDITIONAL PRODUCT INFORMATION

- In ducts where the cable/cable bundle is less than 2.4" (60mm) in diameter, an RDSS-AT/AP-150 device must be used in conjunction with the RDSS-150.
- Standard package: RDSS = 10 kits/box or 3 kits/box
RDSS-CLIP = 5 clips/box

RDSS-TOOLS = 1 each/box, CO2 cartridges = 10 each/box, RDSS-AT/AP-150 = 1 each/box

- Related test report: EDR-5253
- S-1278 sealant, used in RDSS-CLIPS, is available separately.

- For proper inflation do not exceed the maximum cable bundle diameter (MCBD). To determine MCBD, use a diameter tape or contact your TE representative for assistance.

RDSS sealing clip

RDSS duct sealing clips are to be used if the duct is occupied by more than two cables. The maximum number of cables sealed with one RDSS-CLIP is four. If more cables are to be sealed, one extra clip is needed for every three additional cables. Check with your TE Connectivity representative for applications with more than seven cables.

Catalog Number	Kit Used With
RDSS-CLIP-45	RDSS-45
RDSS-CLIP-75	RDSS-75 and RDSS-60
RDSS-CLIP-100	RDSS-100
RDSS-CLIP-125	RDSS-125
RDSS-CLIP-150	RDSS-150

RDSS installation tools

RDSS duct seals can be installed with a variety of inflation tools having the capability of inflating RDSS to 45±3 psi (3 bar) of pressure. The tools TE offers are summarized in the table below. The tool will only accept 16-gr CO2 gas cylinders (listed below).

Catalog Number	Description	Description
RDSS-IT-16	Inflation tool designed with an ON/OFF switch and an automatic pressure-monitoring system. The required CO2 gas cylinders (E7512-0160) must be ordered separately.	1 tool/box
E7512-0160	16-gr CO2 gas cylinders for the RDSS-IT-16 tool. Each gas cylinder inflates approximately four RDSS-100 duct seals.	10 cylinders/box
E7512-0220	Tube snap assembly. Spare part for RDSS-IT-16 inflation tool.	1 each/box
E7512-0240	Spare pressure gauge assembly for RDSS-IT-16 inflation tool.	1 each/box
E7512-0260	Spare delivery pipe for RDSS-IT-16 inflation tool.	1 each box
S-1278-3 x 61 x 7620	RDSS sealant roll (for smaller diameter wires)	1 25-ft roll/box
RDSS-AT/AP-150	For use with the RDSS-150 in duct 5.25" or larger 1 each/box with cable/cable bundles less than 2.4" (60 mm) in diameter.	1 each/box
RDSS-AD-210	Adapter for ducts 6.5 - 8.0" (165 - 210 mm) diameter.	4 each/box
E4540-1250	RDSS-LUBE for installation of RDSS.	25 each/box

RDSS-IT-16



Rayvolve RVS "Roll-on" Splices for 1/C Power Cable (1000 V)

FEATURES

- Qualified to ANSI C119.1, CSA certified to C22.2 No. 198.2, UL listed per 96J4 (file E91151). RUS accepted for use as a secondary tap or splice cover.
- TE's Raychem RVS splice cover sleeves feature a dual-wall design with an entrapped lubricant, making installation fast and simple. The elastomeric sleeve rolls onto the cable with minimal effort, even at temperatures below -15°F (-25°C).

APPLICATIONS

- For use on standard poly- or elastomeric-insulated cables. Use to insulate and seal in-line compression connectors or to seal terminal lugs.
- Specially formulated EPDM elastomer combines with the high-performance sealant to form a water-resistant, insulating sleeve that is UL listed and CSA certified for direct burial application over in-line compression connectors.

BENEFITS

- Easy "roll-on" installation to effectively insulate and seal cable connections up to 1000 V
- Ideal for use where gas or electric heating devices are not approved



Product selection information: dimensions in inches (MM)

Catalog Number	Conductor Size (AWG/kcmil)	Cable OD (min - max)	Sleeve Length	Max Connector Length
RVS-11	#8-2/0	.22-.68 (6-17)	8.0 (205)	5.00 (127)
RVS-12	1/0-250	.50-.90 (13-23)	9.5 (241)	4.50 (114)
RVS-13	250-600	.70-1.20 (18-30)	12.0 (305)	7.00 (178)
RVS-14	600-1000	.95-1.50 (24-38)	14.0 (356)	9.00 (229)

ADDITIONAL PRODUCT INFORMATION

- Select the appropriate catalog number. Selections are based on typical dimensions of low-voltage insulated cable. Confirm selection with dimensions to assure proper sizing.
- Kits do not contain connectors. The RVS splice cover selection information mentioned above covers copper and aluminum in-line compression connections.
- Each kit contains one Rayvolve RVS splice cover sleeve and sealant strips
- Standard package: 5 kits/box or 50 kits/box.

End Caps

For the Protection of Cable Ends

FEATURES

- Made of polyolefin
- Coated with sealing adhesive

APPLICATIONS

- For sealing and protecting cable ends
- Temperature range -40°C to +120°C

TE431004 End caps



Product name	Application range (mm) ²	Inner diameter (mm) ¹		Length (mm)	Wall thickness (mm)	Pack pc	Part Number
		A	B				
102L011/S (S100)	4 – 8	10	4	38	2.0	100	004019N001
102L022/S(S100)	8 – 17	20	7.5	55	2.3	100	766063N001
102L033/S(S100)	17 – 30	35	15	90	3.0	100	845013N001
102L044/S(S50)	30 – 45	55	25	143	3.3	50	160021N001
102L048/S(S25)	45 – 65	73	32	150	3.3	25	679413N001
102L055/S(S10)	65 – 95	100	45	162	3.8	10	385369N001
102L066/S(S10)	95 – 115	120	70	145	3.8	10	922697N001

1	A = as supplied, and B = after free recovery.
2	Printed on the caps.

ZCSM Halogen-Free Heat Shrink Tubing

Raychem Heat-shrinkable Halogen-free, Heavy-wall Tubing for Low Fire Hazard Areas

FEATURES

- Low fire hazard material with low smoke, low toxicity and low acid gas generation
- Prevents corrosion damage by halogenated materials to equipment

APPLICATIONS

- For insulation and protection of personnel and equipment, especially in confined areas

ZCSM



Tubing Size	Application range (mm)	H		W		Part Number
		A max	B min	A* min	B min	
ZCSM-8/3-1500/U	3.5 – 7.0	8	3	0.6	2.0	325585-000
ZCSM-16/5-1500/U	5.5 – 14.5	16	5	0.7	2.4	190625-000
ZCSM-24/8-1500/U	9.0 – 21.5	24	8	0.9	2.9	953711-000
ZCSM-32/12-1500/U	13.0 – 29.0	32	12	1.0	4.0	896101-000
ZCSM-45/16-1500/U	17.5 – 40.5	45	16	1.0	4.0	244025-000
ZCSM-60/22-1500/U	24.0 – 54.0	60	22	1.0	4.0	581907-000
ZCSM-70/25-1500/U	27.5 – 63.0	70	25	1.0	4.0	983291-000
ZCSM-85/36-1000/U	39.5 – 76.5	85	36	1.0	4.0	759985-000
ZCSM-120/50-1500/U	55.0 – 108.0	120	50	1.0	4.2	F19864-000
ZCSM-180/75-1500/U	82.5 – 162.0	180	75	1.0	4.2	102779-000

NOTE 1. 85/36 1000mm lengths, balance 1500mm

MWTM Medium Wall Heat Shrink Tubing

Raychem Heat-shrink Tubing, Medium Wall, Weather and UV-resistant, with or without Adhesive

FEATURES

- Made of modified polyolefin with very high electrical, mechanical, weathering and corrosion properties
- For a tight connection or stress relief, the tubing is available with an internal adhesive coating that melts and seals when shrinkage occurs with heat
- Continuous operating temperature -40°C to +120°C
- Halogen-free, UV and weather resistant

APPLICATIONS

- For electrical insulation where good insulation and mechanical protection is required
- For protection against UV radiation on tails in the case of low-voltage terminations, as well as corrosion protection

Length 1500 mm, adhesive-coated



Product name	Application range (mm)	Inner diameter (mm) ¹		Wall thickness (mm) ¹		Length (mm)	Pack pc	Part Number
		A	B	A	B			
MWTM-10/3-1500/S(S15)	3.5 – 7.0	8	3	0.4	1.0	1500	25	320696-000
MWTM-16/5-1500/S(S15)	5.5 – 14.0	16	5	0.5	1.5	1500	25	830732-000
MWTM-25/8-1500/S(S10)	8.5 – 22	25	8	0.7	2.0	1500	10	142782-000
MWTM-35/12-1500/S(S10)	13.0 – 32.0	35	12	0.7	2.0	1500	10	219394-000
MWTM-50/16-1500/S(S10)	17.0 – 45.0	50	16	0.7	2.0	1500	10	195494-000
MWTM-63/19-1500/S(S5)	21.0 – 57.0	63	19	0.8	2.5	1500	10	514202-000
MWTM-75/22-1500/S(S5)	24.0 – 68.0	75	22	0.9	3.0	1500	5	264027-000
MWTM-85/25-1500/S(S5)	27.0 – 76.0	85	25	0.9	3.0	1500	5	115518-000
MWTM-95/29-1500/S(S5)	31.0 – 85.0	95	29	1.0	3.3	1500	5	326745-000
MWTM-115/34-1500/S(S5)	36.0 – 100.0	115	34	1.0	3.3	1500	5	746340-000
MWTM-140/42-1500/S(S5)	44.0 – 125.0	140	42	1.0	3.5	1500	5	352310-000
MWTM-160/50-1500/S(S5)	52.0 – 145.0	160	50	1.0	3.5	1500	5	663016-000
MWTM-180/60-1500/S(S5)	62.0 – 162.0	180	60	1.1	3.5	1500	5	761200-000
MWTM-245/80-1500	88.0 – 220.0	245	80	n.a.	2.4	1500	5	ON REQUEST
MWTM-285/135	149.0 – 255.0	285	135	n.a.	1.4	1500	5	ON REQUEST

* Uncoated only.

NOTE Other length available on request

Running on spool, not adhesive-coated

Product name	Application range (mm)	Inner diameter (mm) ¹		Wall thickness (mm) ¹		Pack m	Part Number
		A	B	A	B		
MWTM-10/3-A/U-4(S40)	3.5 – 9.0	10	3	0.4	1.0	40	283807-000
MWTM-16/5-A/U-4(S40)	5.5 – 14.0	16	5	0.5	1.5	40	497587-000
MWTM-25/8-A/U-4(S40)	8.5 – 22.0	25	8	0.7	2.0	40	651145-000
MWTM-35/12-A/U-4(S30)	13.0 – 32.0	35	12	0.7	2.0	30	981425-000
MWTM-50/16-A/U-4(S25)	17.0 – 45.0	50	16	0.7	2.0	25	035001-000
MWTM-63/19-A/U-4(S15)	21.0 – 57.0	63	19	0.8	2.5	15	874903-000
MWTM-75/22-A/U-4(S10)	24.0 – 68.0	75	22	0.9	3.0	10	373921-000

1 A = As supplied, and B = after free recovery. Longitudinal change +5 to -15% up to 43/12 and +5 to -10% from 51/16

WCSM Thick Wall Heat Shrink Tubing

Raychem Heat-shrink Tubing, Thick Wall, Weathering and UV-resistant with Adhesive

FEATURES

- Made of modified polyolefin with very high electrical, mechanical, weathering and corrosion properties
- For a tight connection or stress relief, the tubing is available with an internal adhesive coating that melts and seals when shrinkage occurs with heat
- Continuous operating temperature -40°C to +120°C
- Halogen-free, UV and weather resistant

APPLICATIONS

- For electrical insulation where good insulation and mechanical protection is required.

Length 1000 mm, adhesive-coated



Product name	Application range (mm)	Inner diameter (mm) ¹		Wall thickness (mm) ¹		Length (mm)	Pack pc	Part Number
		A	B	A	B			
WCSM-12/3-1500/ S(S20)	3.5 – 10.0	12	3	0.8	2.0	1500	20	CU9253- 000
WCSM-16/4-1500/ S(S20)	4.5 – 14.0	16	4	0.9	2.4	1500	20	CU9272- 000
WCSM-24/6-1500/ S(S10)	6.5 – 22.0	24	6	1.0	2.7	1500	10	CU9434- 000
WCSM-34/8-1500/ S(S10)	9.0 – 31.0	34	8	1.3	4.0	1500	10	CU7134- 000
WCSM-48/12-1500/ S(S10)	13.0 – 44.0	48	12	1.5	4.5	1500	10	CU8545- 000
WCSM-56/16-1500/ S(S10)	17.5 – 50.0	56	16	1.5	4.4	1500	10	CU7529- 000
WCSM-70/20-1500/S(S5)	22.0 – 63.0	70	20	1.4	4.4	1500	5	CU4493-000
WCSM-90/25-1500/S(S5)	27.0 – 81.0	90	25	1.3	4.3	1500	5	CU4610-000
WCSM-110/30-1500/S(S5)	33.0 – 100.0	110	30	1.2	4.3	1500	5	CU6594-000
WCSM-130/35-1500/S(S5)	38.0 – 118.0	130	35	1.2	4.3	1500	5	CU4649-000
WCSM-160/50-1500/S(S5)	55.0 – 144.0	160	50	1.0	4.3	1500	5	846444-000
WCSM-180/50-1500/S(S5)	55.0 – 162.0	180	50	1.0	4.3	1500	5	169440-000

1

A = As supplied, and B = after free recovery.
Longitudinal change +5 to -15% up to 48/12 and +5 to -10% from 56/16

CRSM Wraparounds

Raychem Heat-shrinkable Halogen-free Wraparound System for Plastic or Metal Sheathed Cable Repair

FEATURES

- Fast and permanent wraparounds cable repair and sealing system
- Excellent bonding and sealing characteristics to all materials

APPLICATIONS

- For sheets repair

CRSM



Product name		H		R		W		Part Number
		A min	B max	A min	B max	A min	B max	
CRSM-34/10- 1500/250(S1)	11 – 21	35	9	110	35	0.3	2.4	EN3756-000
CRSM-53/13- 1500/250(S1)	17 – 32	54	15	170	49	0.3	2.0	EN3764-000
CRSM-84/20- 1500/250(S1)	24 – 50	86	21	270	69	0.3	2.0	EN3773-000
CRSM-107/29-1500/250(S1)	31 – 65	108	27	340	90	0.3	2.0	EN3783-000
CRSM-143/36-1500/250(S1)	33 – 86	144	28	455	119	0.3	1.8	EN3792-000
CRSM-198/55-1500/250(S1)	56 – 120	203	50	640	172	0.3	2.1	EN3800-000

ORDERING EXAMPLE

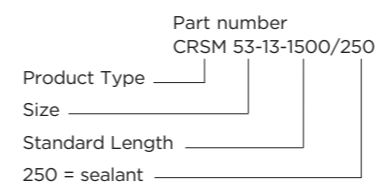



EPKT Heat Shrink Terminations

Raychem Low Voltage Heat-shrink Terminations up to 1 kV

APPLICATION	<ul style="list-style-type: none"> For sealing and protection of indoor or outdoor cable ends on armoured or unarmoured cables For 2, 3 and 4 core cables
FEATURES	<ul style="list-style-type: none"> Hot-melt adhesive-coated cable breakout and sealing sleeves
CONFORMS TO	<ul style="list-style-type: none"> Tested in accordance to CENELEC HD 623 S1.1996 and EN 50393

1 kV 1, 3 and 4-core indoor and outdoor terminations for unarmoured cables

Product name	No of cores	Conductor size (mm ²)	Part number
EPKT 0030 (S10)	3	25 – 50	804937-011
EPKT 0046 (S10)	3	70 – 150	963807-000
EPKT 0062 (S10)	3	185 – 300	208159-011
EPKT 0015 (S20)	4	4 – 16	288775-000
EPKT 0031 (S10)	4	25 – 50	005023-000
EPKT 0047 (S10)	4	70 – 150	597107-000
EPKT 0063 (S10)	4	185 – 300	063097-000

1 kV 1, 2 and 4-core indoor and outdoor terminations for armoured cables

Product name	No of cores	Conductor size (mm ²)	Part number
EPKT 0017 (S5)	2	25 – 50	024865-000
EPKT 0003 (S10)	4	4 – 16	121775-000
EPKT 0019 (S5)	4	25 – 50	868777-000
EPKT 0035 (S5)	4	70 – 150	223409-000
EPKT 0051 (S5)	4	185 – 300	803719-000

EPKT

Raychem Low Voltage Heat-shrink Terminations 3.6 kV

Product name	No of cores	Conductor size (mm ²)	Part number
650mm core tail length			
EPKT 2042	3	25 – 50	796188-011
EPKT 2052	3	70 – 120	796194-000
EPKT 2062	3	150 – 240	796200-011
850mm core tail length			
EPKT 2043	3	25 – 50	796189-011
EPKT 2053	3	70 – 120	796195-011
EPKT 2063	3	150 – 240	796201-000
1200mm core tail length			
EPKT 2044	3	25 – 50	796190-000
EPKT 2054	3	70 – 120	796196-000
EPKT 2064	3	150 – 240	796202-000

EPKJ and AR Inline Joints

Raychem Inline Joints for Plastic and Rubber Insulated Cables up to 1 kV, with or without Armour

FEATURES	APPLICATIONS	CONFORMS TO
<ul style="list-style-type: none"> Heat-shrink adhesive coated tubes Wide application range Suitable for wide range of connectors 	<ul style="list-style-type: none"> Designed for 2, 3 and 4 core cables up to 300 mm² with XLPE, PVC or EPR, with or without armour, PVC or PE sheath 	<ul style="list-style-type: none"> EN 50393

1 kV 4 core joint for armoured cable



Product name	No of cores	Conductor size (mm ²)	Part number
AR101 (SMOE-81283)	4	1.5 – 4	731401-000
AR102 (SMOE-81284)	4	6 – 16	086387-000
AR3 (EPKJ-0130-(S5))	4	25 – 50	630855-000
AR4 (EPKJ-0137-(S5))	4	70 – 150	378703-000
AR5 (EPKJ-0144-(S1))	4	185 – 300	602241-000

1 kV 4 core joint for unarmoured cable



Product name	No of cores	Conductor size (mm ²)	Part number
EPKJ 0228-(S10)	4	1.5 – 6	676955-000
EPKJ 0235-(S10)	4	6 – 16	793331-000
EPKJ 0242(S10)	4	16 – 35	211661-000
EPKJ 0249(S5)	4	35 – 70	637809-000
EPKJ 0256(S5)	4	70 – 150	482979-000
EPKJ 0263(S5)	4	150 – 300	609695-000

TSJ and TBJ Resin Filled Joints

Raychem Low Voltage Resin Filled Joints for Armoured Cables up to 1 kV

FEATURES

- Rigid clear high-impact shells
- Armour continuity components included
- Suitable for a broad range of connectors

APPLICATIONS

- Designed for 2, 3 and 4 core cables up to 300 mm² with XLPE, PVC or EPR, with or without armour, PC or PE sheath

CONFORMS TO

- BS 7888
- CENELEC HD623
- EN 50393

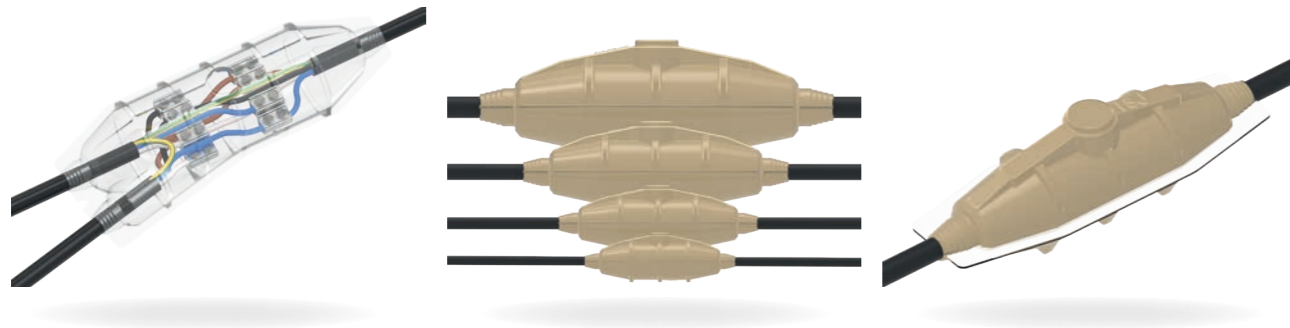

TBS, TBJ

Product name	Conductor size (mm ²)	Product number
BAH-038080672	TSJ-6	D44929-000
BAH-038080673	TSJ-16	C13884-000
BAH-038080674	TSJ-35	A80251-000
BAH-038080675	TSJ-70	A55202-000
BAH-038080676	TSJ-120	E96081-000
BAH-038080677	TSJ-185	E90897-000
BAH-038080678	TSJ-300	E92066-000
BAH-038080679	TBJ-6	A66977-000
BAH-038080680	TBJ-16	A71740-000
BAH-038080681	TBJ-35	C86482-000
BAH-038080682	TBJ-70	A52841-000
BAH-038080683	TBJ-120	E97389-000
BAH-038080684	TBJ-185	F04415-000
BAH-038080685	TBJ-300	C54263-000

GelWrap Water Resistant Wraparound Splice Closures (1000 V)

FEATURES

- PowerGel silicone sealant in TE's Raychem GelWrap closure encapsulates the connection
- Corrugated design enables greater range taking ability
- Qualified to ANSI C119.1

APPLICATIONS

- Insulate and seal buried electrical connections rated up to 1000 volts
- Jacket repair
- Engineered to handle the harsh environments of direct burial and manhole applications

BENEFITS

- PowerGel conforms to substrate providing reliable seal against moisture ingress
- Quick installation, snap closure
- No special tools required
- Excellent insulating properties
- Easy, clean re-entry into electrical connection
- Unlimited shelf life

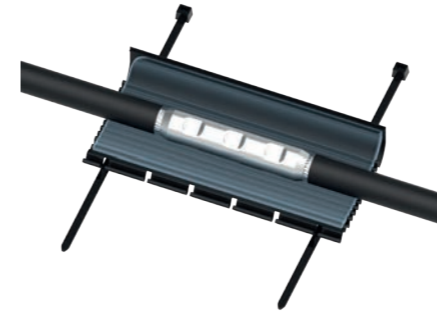

Testing	Test Conditions
ANSI C119.1	600 V insulated underground
Chemical Resistance	Fluid immersion, 168 hours @ 23°C, 75% elongation retention minimum <ul style="list-style-type: none"> • 10W-40 motor oil • 10% hydrochloric acid • 15% sodium chloride • 20% sodium hydroxide • ETX 60280 antifreeze (1000 hours)
Accelerated Aging	1000 hours @ 135°C <ul style="list-style-type: none"> • 93% retention tensile strength • 82% retention elongation at break

PRODUCT SELECTION INFORMATION: DIMENSIONS IN INCHES (MM)

Catalog Number	Sleeve Length	Conductor Size	Max Connector Opening	Max General Use Diameter Range	Std. Pack
GelWrap-18/4-100	4.0 (100)	#12-4/0 (4-95)	1.0 (25)	0.15-0.70 (4-18)	6
GelWrap-18/4-150	6.0 (150)	#12-4/0 (4-95)	3.0 (75)	0.15-0.70 (4-18)	6
GelWrap-18/4-200	8.0 (200)	#12-4/0 (4-95)	5.0 (125)	0.15-0.70 (4-18)	6
GelWrap-18/4-250	10.0 (250)	#12-4/0 (4-95)	7.0 (175)	0.15-0.70 (4-18)	6
GelWrap-18/4-300	12.0 (300)	#12-4/0 (4-95)	9.0 (225)	0.15-0.70 (4-18)	6
GelWrap-33/10-150	6.0 (150)	#2-500 (35-240)	2.0 (50)	0.40-1.30 (10-33)	6
GelWrap-33/10-200	8.0 (200)	#2-500 (35-240)	4.0 (100)	0.40-1.30 (10-33)	6
GelWrap-33/10-250	10.0 (250)	#2-500 (35-240)	6.0 (150)	0.40-1.30 (10-33)	6
GelWrap-33/10-300	12.0 (300)	#2-500 (35-240)	8.0 (200)	0.40-1.30 (10-33)	12
GelWrap-33/10-350	14.0 (350)	#2-500 (35-240)	10.0 (250)	0.40-1.30 (10-33)	10
GelWrap-50/20-200	8.0 (200)	250-750	2.0 (50)	0.80-1.50 (20-38)	12
GelWrap-50/20-250	10.0 (250)	250-750	4.0 (100)	0.80-1.50 (20-38)	12
GelWrap-50/20-300	12.0 (300)	250-750	6.0 (150)	0.80-1.50 (20-38)	12
GelWrap-50/20-350	14.0 (350)	250-750	8.0 (200)	0.80-1.50 (20-38)	12
GelWrap-50/20-400	16.0 (400)	250-750	10.0 (250)	0.80-1.50 (20-38)	12
GelWrap-UF-200	8.0 (200)	14/2-8/3 w/ground	N/A	N/A	10

GILS Gel In-Line Water Resistant Splice Kit for Power Cable (1000 V)

FEATURES

- Connector accommodates copper and/or aluminum cables
- Qualified to ANSI C119 for underground splicing
- UV resistant
- Qualified for temperatures from -40°C to 90°C
- Connector included
- RUS accepted connector blocks and splices for secondary
- Water-tight for use in all locations

APPLICATIONS

- TE's Raychem GILS gel in-line splice kits, offer a state-of-the-art sealed splice for underground, buried, and overhead applications. GILS closures offer a fast and simple method for splicing, insulating, and environmentally sealing low-voltage cable splices.

BENEFITS

- TE's Raychem PowerGel conforms to substrate providing reliable seal against moisture ingress
- Quick installation, snap closure
- No special tools required
- Excellent insulating properties
- Easy, clean re-entry into electrical connection
- Unlimited shelf life



PRODUCT SELECTION INFORMATION: DIMENSIONS IN INCHES (MM)

Catalog Number	Conductor Size (AWG/kcmil)	Std. Pack
GILS-4/0	#2-4/0	18 or 72 each
GILS-350	1/0-350	18

ADDITIONAL PRODUCT INFORMATION

- Based on typical dimensions for low-voltage insulated cables.
- Related test reports: EDR-5298, EDR-5394.

GTAP Water Resistant Splices (1000 V)

FEATURES

- Molded cover of UV stable, impact-resistant polypropylene provides rugged protection for underground or overhead applications
- TE's Raychem gel conforms to substrate to effectively seal out moisture and contaminants
- Four port (2-in, 2-out design), range-taking mechanical connectors splice a wide range of copper and aluminum cables

APPLICATIONS

- Connect, insulate, and seal low-voltage splices (1000V)
- Commonly used in street lighting applications

BENEFITS

- PowerGel conforms to substrate providing reliable seal against moisture ingress
- Quick installation, snap closure
- No special tools required
- Excellent insulating properties
- Easy, clean re-entry into electrical connection
- Unlimited shelf life when stored in normal conditions



SELECTION INFORMATION: DIMENSIONS IN INCHES (MM)

Catalog Number	Conductor Size (All Outlets) AWG (mm ²)	Length	Width	Height	Standard Pack
GTAP-1	#14-#2 (2-35)	2.75 (70)	1.625 (41)	1.0625 (27)	18 or 72
GTAP-2	#14-2/0 (2-70)	4.25 (108)	2 (51)	1.1875 (30)	18 or 72

ADDITIONAL PRODUCT INFORMATION

- Selection based on typical dimensions of low-voltage insulated cables.

Molded cover of UV stable, impact resistant polypropylene provides rugged protection for underground or overhead applications.

Range-taking mechanical connector made of aluminum. Accepts both copper and aluminum conductors.

Frangible fingers provide wide cable range.

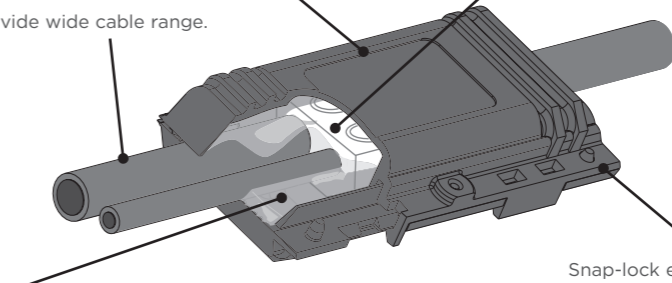

Snap-lock ensures that cover remains closed.

Silicone gel is high dielectric insulation and provides constant pressure on cable and connector to provide waterseal. PowerGel sealant is specifically formulated for high temperature environments.

GHFC Water Resistant H-Frame Closure for Power Cable (1000 V)

FEATURES

- Molded cover of UV stable, impact-resistant polypropylene provides rugged protection for underground or overhead applications
- Gel conforms to substrate to effectively seal out moisture and contaminants
- Qualified to ANSI C119.1
- Qualified for temperatures from -40°C to 90°C

APPLICATIONS

- Fast, simple method for insulating and environmentally sealing low-voltage cable-taps and splices made with H-frame compression connectors. Common applications are street light connections and overhead transformer leads

BENEFITS

- TE's Raychem PowerGel conforms to substrate providing reliable seal against moisture ingress
- Quick installation, snap closure
- No special tools required
- Excellent insulating properties
- Easy, clean re-entry into electrical connection
- Unlimited shelf life when stored in normal conditions



ADDITIONAL PRODUCT INFORMATION

- Select the appropriate catalog number. Selections are based on typical dimensions for low-voltage, insulated cables and connectors.
- Approved connectors (supplied by others) include, but are not limited to:

Product	Approved Connectors
GHFC-1-90	Homac UB214; T&B 63105; Blackburn WR9; Burndy YPC2A8U
GHFC-2-90	Homac OB22, OB44, OB102, OB103; Burndy YHO-1, YHO-2, YHO100, YHO125, YHO150; Blackburn WR139, WR159, WR179, WR199; ILSCO AH1; T&B 63110; UTILCO HT1, HT2

- Standard packs of 100 ea. are also available. Substitute a (B100) in place of the (B10) in the catalog number.
- Related test report: GHFC-1-90 and GHFC-2-90, EDR-5264, GHFC-3-90,

PRODUCT SELECTION INFORMATION: DIMENSIONS IN INCHES (MM)

Catalog Number	Conductor Size		Die	Box Dimensions			Std Pack
	Main	Std. Tap		Length	Width	Height	
GHFC-1-90	#6-#2	#14-#8	BG	2.75 (70)	1.625 (41)	1.0625 (27)	10 or 100
GHFC-2-90	#2-2/0	#14-#6	O	4.25 (108)	2.0 (51)	1.1875 (30)	10 or 100
GHFC-2.5-90	1/0-4/0	#6-3/0	D	7.032 (179)	2.75 (70)	1.560 (40)	30 each
GHFC-3-90	350	4/0	D	6.25 (159)	3.250 (83)	1.90 (49)	6 or 18

Molded cover of UV stable, impact resistant polypropylene provides rugged protection for underground or overhead applications.

Frangible fingers provide wide cable range.

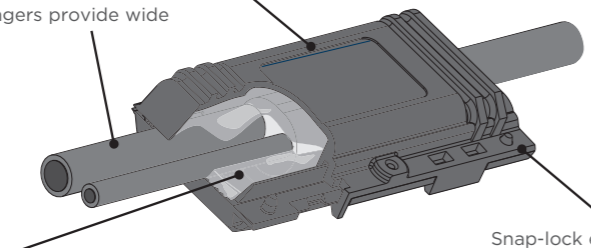

Snap-lock ensures that cover remains closed.

Silicone gel is high dielectric insulation and provides constant pressure on cable and connector to provide waterseal. PowerGel sealant is specifically formulated for high temperature environments.

Gelport Submersible Connectors for URD Distribution (1000 V)

FEATURES

- TE's Raychem GelPort is qualified to ANSI C119.1
- Gel-filled cable entry ports provide a reliable cable seal
- PowerGel sealing gel seals out harsh environments
- Rugged, impact-resistant housing stands up to rough installations
- Clear view back allows for easy positive visual indication of wire position in connector

APPLICATIONS

- Multi-port secondary connectors for low voltage submersible (hand hole / man hole) applications

BENEFITS

- TE's Raychem PowerGel conforms to substrate providing reliable seal against moisture ingress
- Quick and easy installation
- Clean re-entry into electrical connection
- Unlimited shelf life when stored in normal conditions
- No loose parts due to one piece housing



Testing	Approved Connectors
Complete unit	ANSI C119.1, Report: EDR-5379, EDR-5409, EDR-5427, EDR 5463
Connector	ANSI C119.4, Report: 502-47264, 502-47302, 502-47308
Chemical Resistance	ASTM D543 to the following liquids: Sulfuric Acid, Sodium Sulfate, Sodium Chloride, Sodium Hydroxide, Ethylene Glycol
UV Resistance	ASTM G-53-95, ASTM-D-638-95

Catalog Number*	Number of Wire Ports	Conductor Use Range (mm ²)	Length	Width	Height	Std. Pack
GelPort 350/500						
GPRT-350-3P(B6)	3	14-350 (2-150)	4.60 (117)	3.825 (97)	3.50 (89)	6
GPRT-350-4P(B6)	4	14-350 (2-150)	5.85 (149)	3.825 (97)	3.50 (89)	6
GPRT-350-5P(B6)	5	14-350 (2-150)	7.10 (180)	3.825 (97)	3.50 (89)	6
GPRT-350-6P(B6)	6	14-350 (2-150)	8.35 (212)	3.825 (97)	3.50 (89)	6
GPRT-350-8P(B6)	8	14-350 (2-150)	10.85 (276)	3.825 (97)	3.50 (89)	6
GPRT-350/4P-500/1P (B6)	5 Hybrid	-	7.10 (180)	3.825 (97)	3.50 (89)	6
	4	14-350 (2-150)	-	-	-	-
GPRT-350/6P-500/2P (B6)	1	6-500 (16-250)	-	-	-	-
	8 Hybrid	-	10.85 (276)	3.825 (97)	3.50 (89)	6
GPRT-350/6P-500/2P (B6)	6	14-350 (2-150)	-	-	-	-
	2	6-500 (16-250)	-	-	-	-

Catalog Number*	Clear View	Number of Wire Ports	Max Cable OD	Max Number	Length	Width	Height
GelPort 500							
GPRT-500-3P(B6)	C	3	0.96	1 (#6-500 kcmil)	4.6 (117)	3.825 (97)	3.50 (89)
GPRT-500-4P(B6)	C	4	0.96	2 (#6-500 kcmil)	5.85 (149)	3.825 (97)	3.50 (89)
GPRT-500-5P(B6)	C	5	0.96	3 (#6-500 kcmil)	7.1 (180)	3.825 (97)	3.50 (89)
GPRT-500-6P(B6)	C	6	0.96	4 (#6-500 kcmil)	8.35 (212)	3.825 (97)	3.50 (89)
GPRT-500-8P(B6)	C	8	0.96	6 (#6-500 kcmil)	10.85 (276)	3.825 (97)	3.50 (89)

* For Clear view back housing, add "-C" to end of catalog number. Standard housing is black.

ADDITIONAL PRODUCT INFORMATION

- Selection based on typical dimensions of low voltage cables.
- Standard package is 6/box.

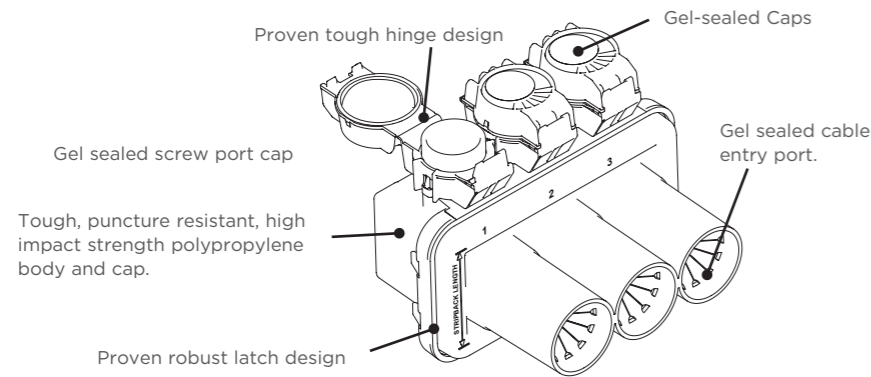

GelCap Water Resistant Stub Splice Covers (1000 V)

FEATURES

- TE's Raychem GelCap gel conforms to substrate to effectively seal out moisture and contaminants
- Corrugated cover design increases range-taking ability
- UL Listed for US and Canada (CUL) 105°C

APPLICATIONS

- Insulate, seal, and protect stub splice connections up to 1000 volts. Common applications include motor connections, street lights, HVAC, landscape lighting, and irrigation systems.

BENEFITS

- TE's Raychem PowerGel conforms to substrate providing reliable seal against moisture ingress
- Quick installation, snap closure
- No special tools required
- Excellent insulating properties
- Easy, clean re-entry into electrical connection

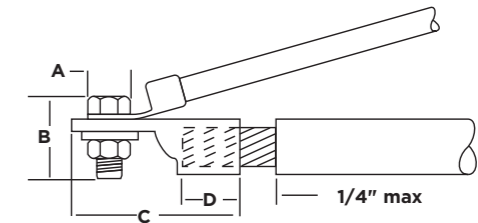

Testing	Test Conditions
Chemical Resistance	ASTM D543, Sulfuric acid, Sodium hydroxide and motor oil
Ozone Resistance	ASTM D1149, 168 hours @40°C, 50pphm
Accelerated Aging	ASTM D2671
Abrasion Resistance	2040 gm wt., 4000 cycles, 2% max thickness loss

SELECTION INFORMATION: DIMENSIONS IN INCHES (MM)

Max Bolt Dimensions							
Catalog Number	Feeder Conductor Size (mm)	Width (A)	Length (B)	Max Lug Dimensions Total Length (C)	Barrel Length (D)	Cap Length (Nominal)	Standard Pack
GelCap 1(B5)*	#16-#10 AWG (1.5-5)	.375 (10)	.500 (13)	1.00 (25)	0.5 (13)	2.8 (71)	5
GelCap 2(B5)	#8-#2 AWG (8-35)	.625 (16)	1.00 (25)	2.00 (51)	1.0 (25)	3.5 (89)	5
GelCap 3(B5)	#2-#4/0 AWG (35-105)	.850 (22)	1.30 (33)	3.00 (76)	1.5 (38)	6.0 (152)	5
GelCap 4(B5)	250-500 kcmil (125-250)	1.100 (28)	1.85 (47)	5.00 (127)	2.0 (51)	8.0 (203)	5

* For wire sizes #16 – #10, the unique design of the GelCap 1 splice kit saves space by allowing all three phase connections to be installed in one cover. Note: GelCap 1 kit contains one GelCap cover only. For GelCap splice kits sizes 2-4, one cap per phase is provided.

ADDITIONAL PRODUCT INFORMATION

- Selection based on typical dimensions of low-voltage insulated cables.
- Kits do not contain connectors.

Silicone gel is high dielectric insulation and provides constant pressure on cable and connector to provide waterseal. PowerGel sealant is specifically formulated for high temperature environments.

Snap-lock feature provides quick installation removal.

Molded cover is abrasion and impact resistant. Elastomer provides rugged protection for electrical connection.

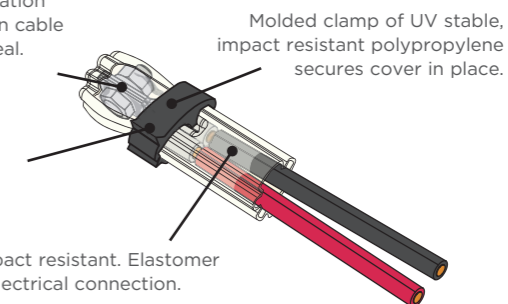

GelCap SL Water Resistant Splice Covers for Street Lights (1000V)

FEATURES

- Three wire connector is perfect for street light connections - two ports accept #14-2/0 AWG for the feeder cables and a single port for a #14-6 AWG wire to power the light.
- Temperature range - 40 °C to 105 °C

APPLICATIONS

- TE's Raychem GelCap SL Insulates, seals, and protects street lighting connections
- Other applications include irrigation systems, HVAC, and motor connections

BENEFITS

- TE's Raychem PowerGel conforms to substrate providing reliable seal against moisture ingress
- Quick installation, snap closure
- No special tools required
- Excellent insulating properties
- Easy, clean re-entry into electrical connection
- Unlimited shelf life when stored in normal conditions



UL US LISTED
600V/1050C

Testing	Test Conditions
Chemical Resistance	ASTM D543, Sulfuric acid, Sodium Hydroxide and motor oil
Ozone Resistance	ASTM D1149, 168 hours @ 40°C, 50 ppm
Accelerated Aging	ASTM D2671
Abrasion Resistance	2040 gm wt., 4000 cycles, 2% max thickness loss

SELECTION INFORMATION: DIMENSIONS IN INCHES (MM)

Catalog Number	Hole A		Hole B		Standard Pack
	Wire Range	Recommended Torque Values	Wire Range	Recommended Torque Values	
GelCap-SL-2/0-3HOLE(B10)	#14-2/0 AWG	120-180 in-lbs	#14-6 AWG	120-150 in-lbs	10
GelCap-SL-2/0-3HOLE-B100	#14-2/0 AWG	120-180 in-lbs	#14-6 AWG	120-150 in-lbs	100

ADDITIONAL PRODUCT INFORMATION

- Selections are based on typical dimensions of low-voltage insulated cables.
- Kits include UL Listed connectors for use with copper and/or aluminum conductors.
- Each kit contains a gel filled cap, cap clamp, and connector.
- Related test reports: EDR-5334, EDR-5352, EDR-5488, EDR-5520.
- Qualified to ANSI C 119.1 per EDR-5520.

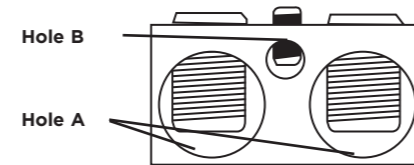

Rayvolve RVC "Roll-on" Stub Connection Splice Cover Kits (1000 V)

FEATURES

- Elastomeric RVC cap splice cover provides the required insulation thickness, withstands abrasion, and forms a water-resistant seal
- Qualified to ANSI C-119.1

APPLICATIONS

- Insulate and seal 1kV stub connections (motor leads and street lights)

BENEFITS

- Fast and easy roll-on installation - Install all 3 phases at the same time
- Tool-free and compact size makes TE's Raychem RVC cap ideal for installation in cramped motor boxes



PRODUCT SELECTION INFORMATION: DIMENSIONS IN INCHES (MM)

Catalog Number	Conductor Size (AWG/kcmil)	Insulation Cut-Back (max)
Three-wire stub splices		
RVC-1V	#14-#8	1.75 (44)
RVC-2V	#6-#2	2.75 (70)
Abrasion Resistance	2040 gm wt., 4000 cycles, 2% max thickness loss	

Catalog Number	Feeder Size (AWG/kcmil)	Bolt Dimensions		Lug Length (max)	Cap Length (Nominal)	Standard Pack
		Size (max)	Length (max)			
Motor Connections or two-wire stub splices						
RVC-1V(B5)	#14-#4	.375 (8)	.625 (15)	1.75 (45)	3.00 (75)	5
RVC-2V(B5)	#8-2/0	.375 (8)	.750 (20)	2.75 (70)	4.00 (100)	5
RVC-3V(B5)	#2-4/0	.500 (12)	1.00 (25)	3.00 (75)	5.25 (130)	5
RVC-4V(B5)	250-500	.625 (16)	1.50 (35)	5.00 (125)	7.50 (190)	5

ADDITIONAL PRODUCT INFORMATION

- Select the appropriate catalog number. Selections are based on typical dimensions of low-voltage insulated cable. Confirm selection with dimensions to assure proper sizing.
- Each kit contains one Rayvolve RVC splice cover sleeve and sealant strips.
- Standard package: 5 kits/box.
- Related test report: EDR-5614.
- For connector information refer to the Connectors and Terminals section of this catalog.

Fuse Boxes for Street Lighting Applications

FEATURES

- For over 60 years, TE's well-known GURO fuse boxes have delivered on performance and reliability – as well as providing a long service life
- Advanced materials science produces robust, highly durable products that withstand harsh environments
- Provide surge protection to reduce randomly occurring voltage spikes in the installation to a level that does not damage LED luminaires
- Our experts can support you from challenging design problems to hands-on field support for stress-free installation

APPLICATIONS

- Public street lighting
- Private outdoor lights for parking lots and apartment buildings
- Industrial settings such as refineries and power plants
- Infrastructure, including harbors, airports and rail stations

BENEFITS

- Meet IEC 61439 (DIN VDE 0661-500) standard
- Reliable performance in harsh environment
- Easy to install



Refer to Standard	Product Name	Selection Criteria	Number And Application Range Of Cables (Cross Section MM²)			Number and Type of Fuse Carriers	Available With Surge Arresters for LED Lighting	Type of Terminals	Ingress Protection	Dimension of Pole (MM)	
			One	Two	Three					Door	Min. Inside Diameter
DIN VDE 0660-505, DIN 43628	EKM-2050	Medium poles, outdoor, medium cables	3-5 x 2,5-16 3-4 x 2,5-25	3-5 x 2,5-16 3-4 x 2,5-25	3,5 x 2,5-16	2 / 3 x D01	1 / 2	Sliding terminals	IP54	85 x 270	89
	EKM-2051	Medium poles, outdoor, medium cables	3-5 x 2,5-16 3-4 x 2,5-25*	3-5 x 2,5-16 3-4 x 2,5-25	3-5 x 2,5-16	2 / 3 x D01	1 / 2	Sliding terminals	IP54	85 x 350	89 (100)
	EKM-2020	Medium poles, medium cables	3-5 x 2,5-16	3-5 x 2,5-16	3-5 x 2,5-16	1 / 2 x D01	1	Mantle terminals	IP44	70 x 240	84
	EKM-2042	Slim poles, outdoor, medium cables	3-5 x 2,5-10	3-5 x 2,5-10	3-5 x 2,5-10	2 x D01	—	Sliding terminals	IP43/IP55	66 x 240	70
	EKM-2045	Bollards, slim poles, outdoor, small cables	3-4 x 1,5-4	3-4 x 1,5-4	—	1 x D01	—	Box terminals	IP55	58 x 150	59
—	EKM-2072	Medium poles, large cables	3-5 x 4-16 3-5 x 25-35	3-5 x 4-16 3-5 x 25-35	—	1 / 2 x DII	1	Mantle terminals	IP43	80 x 280	90
	EKM-2035	Large poles, large cables	3-4 x 4-50	3-4 x 4-50	3-4 x 4-35	1 / 2 x DII	1	Sliding terminals	IP43	90 x 300	110
	EKM-1261	Medium poles, outdoor, medium cables	3-5 x 6-16	3-5 x 6-16	3-5 x 6-10	1 / 2 x D01/ DII	—	Mantle terminals	IP54	80 x 250	95 (100)
	EKM-1261	Submersible medium poles, outdoors	3-5-x 10	3-5-x 10	3-5-x 10	2 / 3 x D01	—	Mantle terminals	IP68	80 x 250	95
	EKM-1281	Large poles, outdoor large cables	3-5 x 16-35	3-5 x 16-35	3-4 x 16	2 / 3 x D01 1 / 2 x DII	—	Sliding terminals	IP54	100 x 300	120
	EKM-1281	Submersible large poles, outdoors	3-5 x 2,5-16 3-4 x 2,5-25	3-5 x 2,5-16 3-4 x 2,5-25	—	2 / 3 x D01	—	Sliding terminals	IP68	100 x 300	120
	EKM-1271	Medium poles, medium cables	3-5 x 6-16	3-5 x 6-16	—	1 x DII	—	Mantle terminals	IP43	80 x 210	90
	EKM-1272	Medium poles, medium cables	3-5 x 6-16	3-5 x 6-16	—	2 x DII	—	Mantle terminals	IP43	80 x 250	90



Chapter II Medium Voltage Cable Accessories

APKT Heat Shrink Terminations up to 36 kV	36
EPKT Heat Shrink Terminations up to 33 kV	39
IXSU/OXSU Heat Shrink Terminations up to 24 kV	43
EPKJ Heat Shrink Joints up to 36 kV	45
MXSU/MXST/MXSW/MXAW Heat Shrink Joints with Mechanical Connector up to 36 kV	49
SXSU/SXST/SXSW/SXAW Heat Shrink Joints for Polymeric Cables up to 36 kV	51
RICS Insulated Adapter Termination System up to 24 kV	53
RCAB Elastomeric Insulating Bushing Boots up to 24 kV	54
CSJT Cold Shrink Joints up to 36 kV	55
CSTI/CSTO Cold Shrink Terminations up to 24 kV	56
ELBC Screened Separable Connectors up to 24 kV	58
RSTI Screened Separable Connectors up to 36 kV	62
RSTI-CC Screened Coupling Connectors up to 36 kV	63
RSTI-SA Screened Connectors with Surge Arrester up to 36 kV	64
RSES 64xx Screened Adapter System up to 36 kV	65
RSES and RSSS-52XX	66
RSRB Heat Shrink Bushing Boots up to 11 kV	67
RPIT Plug-in Terminations up to 42 kV	68
RSTF Separable Connectors up to 72,5 kV	69

APKT

Heat-shrinkable Termination for Cables up to 36 kV

FEATURES

- Universal termination family for 7.2-36 kV based on Raychem SCTM stress control technology;
- Red non-tracking Raychem HVOT tubing provides excellent environmental protection Längswasserdicht

APPLICATIONS

- All applications for polymeric 1-core, 3-core, armoured and unarmoured cables;
- Can be used in combination with Raychem RICS / RCAB / RSRB switchgear connection systems

BENEFITS

- Tested in accordance to CENELEC
- HD.629.1.S2:2006, IEC 60502-4 and IEEE 48



SELECTION INFORMATION: DIMENSIONS SHOWN IN MILLIMETERS

Product Family

- up to 7.2 kV
- 12 and 17.5 kV
- 24 kV
- 36 kV

Cable Cross Section

7.2kV mm ²	12/17.5kV mm ²	24kV mm ²	36kV mm ²
16-50	16-35	25-35	
70-120	50-70	50-70	35-50
150-240	95-240	95-185	70-120
300-500	300-400	240-400	15-185
630-1000	500-800 1000	500-630 800-1000	240-500 630-1000

Number of Cores

- Single Core
- 3-Core

Dielectric or Insulation Type

- XLPE

Location of Installation

- Indoor
- Outdoor

Length of Termination Tail (3-Core only)

- for 450 mm
- for 650 mm
- for 800 mm
- for 1200 mm

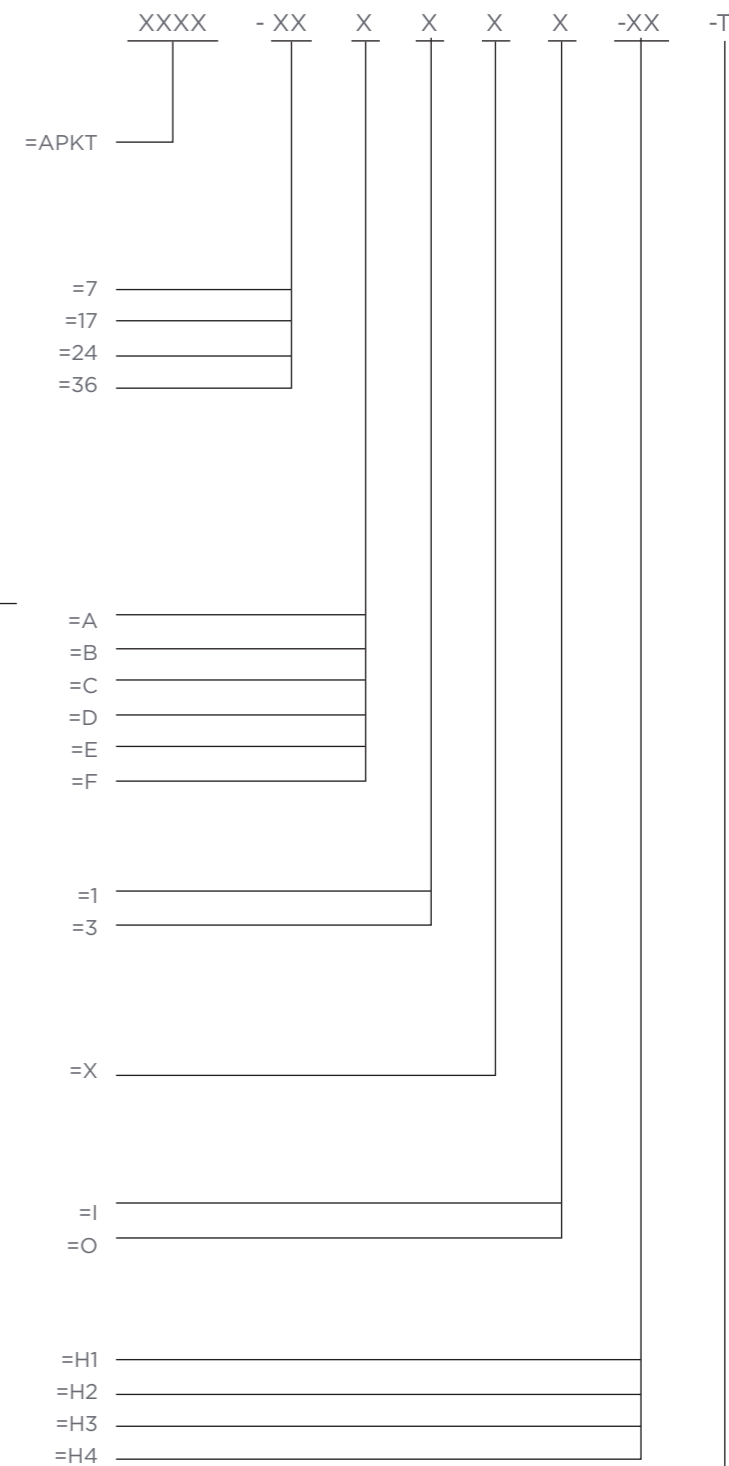

ACCESSORIES

Not include termination accessories such as cable lug, armour kit, ground connector, bolt & nut, earth braid.

Ordering Example: APKT-17C 3X O-H3-T
Outdoor termination for 12/17.5 kV, 120 mm² 3-core XLPE cable, tail length 800 mm.

TE's Raychem termination kit for XLPE cable without armour

Voltage (kV)	Cable Size (mm ²)	Single Core		Three Core	
		Indoor	Outdoor	Indoor	Outdoor
7.2	16-50	APKT 7A1XI-T	APKT 7A1X0-T	APKT 7A3XI-H2-T	APKT 7A3X0-H2-T
	70-120	APKT 7B1XI-T	APKT 7E1X0-T	APKT 7B3XI-H2-T	APKT 7B3X0-H2-T
	150-240	APKT 7C1XI-T	APKT 7C1X0-T	APKT 7C3XI-H2-T	APKT 7C3X0-H2-T
	300-500	APKT 7D1XI-T	APKT 7D1X0-T	APKT 7D3XI-H2-T	APKT 7D3X0-H2-T
	630-1000	APKT 7E1XI-T	APKT 7E1X0-T	-	-
12-17.5	15-35	APKT 17A1XI-T	APKT 17A1X0-T	APKT 17A3XI-H2-T	APKT 17A3X0-H2-T
	50-70	APKT 17B1XI-T	APKT 17B1X0-T	APKT 17B3XI-H2-T	APKT 17B3X0-H2-T
	95-240	APKT 17C1XI-T	APKT 17C1X0-T	APKT 17C3XI-H2-T	APKT 17C3X0-H2-T
	300-400	APKT 17D1XI-T	APKT 17D1X0-T	APKT 17D3XI-H2-T	APKT 17D3X0-H2-T
	500-800	APKT 17E1XI-T	APKT 17E1X0-T	-	-
	1000	APKT 17F1XI-T	APKT 17F1X0-T	-	-
24	25-35	APKT 24A1XI-T	APKT 24A1X0-T	APKT 24A3XI-H2-T	APKT 24A3X0-H3-T
	50-70	APKT 24B1XI-T	APKT 24B1X0-T	APKT 24B3XI-H2-T	APKT 24B3X0-H3-T
	95-185	APKT 24C1XI-T	APKT 24C1X0-T	APKT 24C3XI-H2-T	APKT 24C3X0-H3-T
	240-400	APKT 24D1XI-T	APKT 24D1X0-T	APKT 24D3XI-H2-T	APKT 24D3X0-H3-T
	500-630	APKT 24E1XI-T	APKT 24E1X0-T	-	-
	800-1000	APKT 24F1XI-T	APKT 24F1X0-T	-	-
36	35-50	APKT 36B1XI-T	APKT 36B1X0-T	APKT 36B3XI-H2-T	APKT 36B3X0-H3-T
	70-120	APKT 36C1XI-T	APKT 36C1X0-T	APKT 36C3XI-H2-T	APKT 36C3X0-H3-T
	150-185	APKT 36D1XI-T	APKT 36D1X0-T	APKT 36D3XI-H2-T	APKT 36D3X0-H3-T
	240-500	APKT 36E1XI-T	APKT 36E1X0-T	APKT 36E3XI-H2-T	APKT 36E3X0-H3-T
	630-1000	APKT 36F1XI-T	APKT 36F1X0-T	-	-

Note: For armoured cables, please contact your local sales representative



EPKT

Raychem Medium Voltage Heat-shrink Terminations up to 7.2 kV

FEATURES

- Universal termination family for 12-36 kV based on Raychem SCTM stress control technology
- Red non-tracking Raychem HVOT tubing provides excellent environmental protection

APPLICATIONS

- All applications for polymeric 1-core, 3-core, armoured and unarmoured cables
- Can be used in combination with Raychem RICS / RCAB / RSRB switchgear connection systems

CONFORMS TO

- Tested in accordance to CENELEC HD.629.1.S2:2006, IEC 60502-4 and IEEE 48

Length of termination tail (3-core only)

for 450 mm = H1
for 650 mm = H2
for 800 mm = H3
for 1200 mm = H4

7.2 kV 1-core indoor terminations for polymeric cables

Product name	Conductor size (mm ²)	Part number
EPKT 7A1XI	16 – 50	369608-011
EPKT 7B1XI	70 – 120	034189-000
EPKT 7C1XI	150 – 240	882065-011
EPKT 7D1XI	300 – 500	769766-011
EPKT 7E1XI	630 – 1000	393728-000

7.2 kV 1-core outdoor terminations for polymeric cables

Product name	Conductor size (mm ²)	Part number
EPKT 7B1X0	70 – 120	240394-000
EPKT 7C1X0	150 – 240	519922-011
EPKT 7D1X0	300 – 500	318838-011
EPKT 7E1X0	630 – 1000	619899-011

7.2 kV 3-core indoor terminations for polymeric cables

Product name	Conductor size (mm ²)	Part number
EPKT 7C3XIH2	150 – 240	310407-011
EPKT 7C3XIH3	150 – 240	565544-011
EPKT 7D3XIH2	300 – 500	TBC

7.2 kV 3-core outdoor terminations for polymeric cables

Product name	Conductor size (mm ²)	Part number
EPKT 7C3XOH2	150 – 240	964985-000
EPKT 7D3XOH1	300 – 500	955857-000
EPKT 7D3XOH3	300 – 500	895086-000

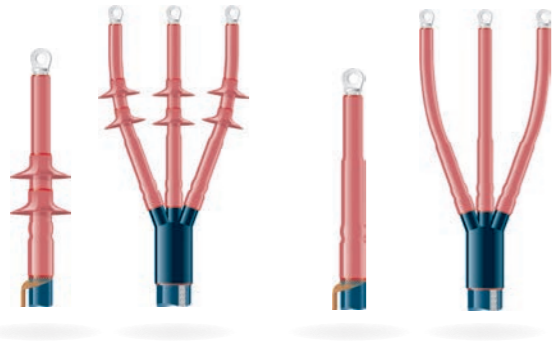
**Length of termination tail (3-core only)**

for 450 mm = H1
for 650 mm = H2
for 800 mm = H3
for 1200 mm = H4

Raychem Medium Voltage Heat-shrink Terminations up to 17.5 kV

Product name	Conductor size (mm ²)	Part number
17.5 kV 1-core indoor terminations for polymeric cables		
EPKT 17B1XI	35 – 70	500365-011
EPKT 17C1XI	95 – 240	068756-011
EPKT 17D1XI	300 – 400	328499-011
EPKT 17E1XI	500 – 800	027618-011
EPKT 17F1XI	1000	896210-011
17.5 kV 1-core outdoor terminations for polymeric cables		
EPKT 17B1XO	35 – 70	595847-011
EPKT 17C1XO	95 – 240	931928-011
EPKT 17D1XO	300 – 400	206772-011
EPKT 17E1XO	500 – 800	712995-011
EPKT 17F1XO	1000	051492-011
17.5 kV 3-core indoor terminations for polymeric cables		
EPKT 17A3XIH2	16 – 25	842908-011
EPKT 17A3XIH4	16 – 25	154667-011
EPKT 17B3XIH2	35 – 70	007825-011
EPKT 17B3XIH4	35 – 70	663811-011
EPKT 17C3XIH2	95 – 240	258166-011
EPKT 17C3XIH4	95 – 240	889147-011
EPKT 17D3XIH2	300 – 400	789902-011
EPKT 17D3XIH4	300 – 400	405002-011
17.5 kV 3-core outdoor terminations for polymeric cables		
EPKT 17A3XOH2	16 – 25	470454-000
EPKT 17A3XOH3	16 – 25	208196-000
EPKT 17B3XOH2	35 – 70	168183-011
EPKT 17B3XOH4	35 – 70	283692-011
EPKT 17C3XOH2	95 – 240	181259-011
EPKT 17C3XOH4	95 – 240	667923-000
EPKT 17D3XOH3	300 – 400	747026-000
EPKT 17D3XOH4	300 – 400	434873-011
17.5 kV 3-core indoor terminations for paper cables		
EPKT 17A3MIH2	16 – 25	818652-000
EPKT 17A3MIH4	16 – 25	251778-000
EPKT 17B3MIH2	35 – 70	085596-011
EPKT 17B3MIH4	35 – 70	006552-000
EPKT 17C3MIH2	95 – 240	025719-011
EPKT 17C3MIH4	95 – 240	835269-011
EPKT 17D3MIH2	300 – 400	321575-011
17.5 kV 3-core outdoor terminations for paper cables		
EPKT 17A3MOH2	16 – 25	468180-000
EPKT 17A3MOH4	16 – 25	TBC
EPKT 17B3MOH2	35 – 70	740131-011
EPKT 17B3MOH3	35 – 70	152178-000
EPKT 17C3MOH2	95 – 240	158810-011
EPKT 17C3MOH4	95 – 240	313358-011
EPKT 17D3MOH2	300 – 400	604082-011
EPKT 17D3MOH4	300 – 400	702854-011

EPKT

Raychem Medium Voltage Heat-shrink Terminations up to 17.5 kV

FEATURES

- Universal termination family for 12-36 kV based on Raychem SCTM stress control technology
- Red non-tracking Raychem HVOT tubing provides excellent environmental protection

APPLICATIONS

- All applications for polymeric and MIND paper on 1-core, 3-core, armoured and unarmoured cables
- Can be used in combination with Raychem RICS / RCAB / RSRB switchgear connection systems

CONFORMS TO

- Tested in accordance to CENELEC HD.629.1.S2:2006, IEC 60502-4 and IEEE 48

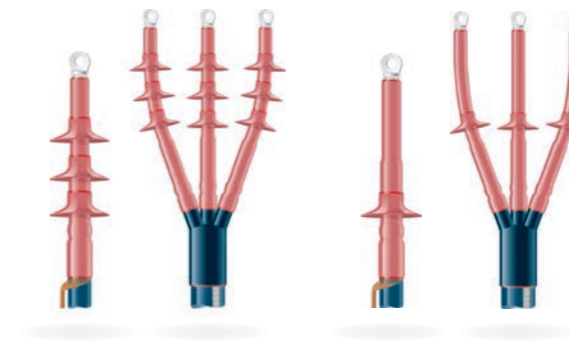
**Length of termination tail (3-core only)**

for 450 mm = H1
for 650 mm = H2
for 800 mm = H3
for 1200 mm = H4

Raychem Medium Voltage Heat-shrink Terminations up to 24 kV

Product name	Conductor size (mm ²)	Part number
24 kV 1-core indoor terminations for polymeric cables		
EPKT 24B1XI	25 – 50	562168-000
EPKT 24C1XI	70 – 185	922196-011
EPKT 24D1XI	240 – 300	451649-000
EPKT 24E1XI	400 – 630	975658-011
EPKT 24F1XI	800 – 1000	306994-000
24 kV 1-core outdoor terminations for polymeric cables		
EPKT 24B1XO	25 – 50	613670-011
EPKT 24C1XO	70 – 185	278218-011
EPKT 24D1XO	240 – 300	485566-000
EPKT 24E1XO	400 – 630	792760-011
EPKT 24F1XO	800 – 1000	844961-000
24 kV 1-core indoor terminations for paper cables		
EPKT 24B1MI	25 – 50	047852-000
EPKT 24C1MI	70 – 185	503845-000
EPKT 24D1MI	240 – 300	198763-000
24 kV 3-core indoor terminations for polymeric cables		
EPKT 24B3XIH2	25 – 50	658587-011
EPKT 24B3XIH3	25 – 50	TBC
EPKT 24C3XIH2	70 – 185	397856-011
EPKT 24C3XIH4	70 – 185	773849-000
EPKT 24D3XIH2	240 – 300	428150-011
24 kV 3-core outdoor terminations for polymeric cables		
EPKT 24B3XOH3	25 – 50	462038-011
EPKT 24C3XOH4	70 – 185	855463-011
EPKT 24D3XOH3	240 – 300	896693-011
24 kV 3-core indoor terminations for paper cables		
EPKT 24B3MIH2	25 – 50	957227-000
EPKT 24C3MIH2	70 – 185	136493-000
EPKT 24D3MIH2	240 – 300	724317-000
24 kV 3-core outdoor terminations for paper cables		
EPKT 24B3MOH3	25 – 50	483103-000
EPKT 24C3MOH3	70 – 185	499917-000
EPKT 24C3MOH4	70 – 185	915409-000
EPKT 24D3MOH3	240 – 300	516181-000
EPKT 24D3MOH4	240 – 300	013571-000

EPKT

Raychem Medium Voltage Heat-shrink Terminations up to 24 kV

FEATURES

- Universal termination family for 12-36 kV based on Raychem SCTM stress control technology
- Red non-tracking Raychem HVOT tubing provides excellent environmental protection

APPLICATIONS

- All applications for polymeric and MIND paper on 1-core, 3-core, armoured and unarmoured cables
- Can be used in combination with Raychem RICS / RCAB / RSRB switchgear connection systems

CONFORMS TO

- Tested in accordance to CENELEC HD.629.1.S2:2006, IEC 60502-4 and IEEE 48

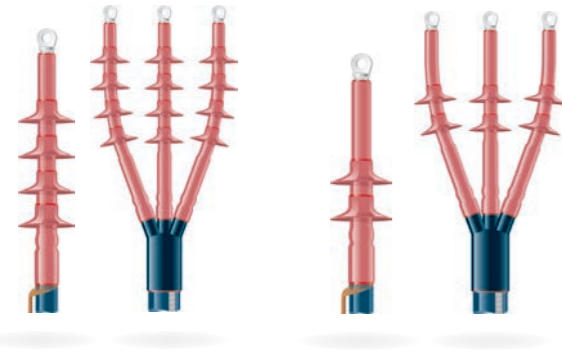

EPKT

Raychem Medium Voltage Heat-shrink Terminations up to 33 kV

FEATURES

- Universal termination family for 12-36 kV based on Raychem SCTM stress control technology
- Red non-tracking Raychem HVOT tubing provides excellent environmental protection

APPLICATIONS

- All applications for polymeric and MIND paper on 1-core, 3-core, armoured and unarmoured cables

CONFORMS TO

- Tested in accordance to CENELEC HD.629.1.S2:2006, IEC 60502-4 and IEEE 48

Length of termination tail (3-core only)

for 450 mm = H1
for 650 mm = H2
for 800 mm = H3
for 1200 mm = H4

Raychem Medium Voltage Heat-shrink Terminations up to 33 kV

Product name	Conductor size (mm ²)	Part number
33 kV 1-core indoor terminations for polymeric cables		
EPKT 36C1XI	50 – 95	454523-011
EPKT 36D1XI	120 – 185	308359-011
EPKT 36E1XI	240 – 500	651264-011
EPKT 36F1XI	630 – 1000	700320-011
TBC	1000	TBC
33 kV 1-core outdoor terminations for polymeric cables		
EPKT 36C1XO	50 – 95	900926-011
EPKT 36D1XO	120 – 185	553365-011
EPKT 36E1XO	240 – 500	372083-011
EPKT 36F1XO	630 – 1000	407002-011
33 kV 3-core indoor terminations for polymeric cables		
EPKT 36C3XIH2	50 – 95	320645-000
EPKT 36C3XIH4	50 – 95	559139-011
EPKT 36D3XIH2	120 – 185	599496-011
EPKT 36D3XIH4	120 – 185	TBC
EPKT 36E3XIH2	240 – 500	174907-011
EPKT 36E3XIH3	240 – 500	683636-011
33 kV 3-core outdoor terminations for polymeric cables		
EPKT 36C3XOH4	50 – 95	921312-011
EPKT 36D3XOH4	120 – 185	060437-011
EPKT 36E3XOH4	240 – 500	496517-011

Note: Indoor and outdoor versions of PILC terminations available on request.
Indoor and outdoor versions of paper MIND terminations available on request.

IXSU/OXSU

Raychem Medium Voltage Heat-shrink Zinc Oxide Stress Control Terminations up to 12 kV



FEATURES

- Universal termination family for 12 kV based on unique Raychem zinc oxide stress control technology
- Red co-extruded non-tracking Raychem zinc oxide HVOT tubing provides excellent environmental protection
- Compact design
- Conductive break-out and CNTM core extension tubes allow crossing of cores

APPLICATIONS

- All applications for polymeric 1-core, 3-core, armoured and unarmoured cables
- Can be used in combination with Raychem RICS / RCAB / RSRB switchgear connection systems

CONFORMS TO

- Tested in accordance to CENELEC HD.629.1.S2:2006, IEC 60502-4 and IEEE 48



Raychem Medium Voltage Heat-shrink Zinc Oxide Stress Control Terminations up to 12 kV

Product name	Conductor size (mm ²)	Part number
12 kV 1-core indoor terminations for polymeric cables		
IXSU-F 3111	10 – 35	508493-011
IXSU-F 3121	25 – 95	489269-011
IXSU-F 3131	95 – 240	097105-011
IXSU-F 3141	240 – 500	422037-011
IXSU-F 3151	500 – 800	565915-011
IXSU-F 3161	1000 – 1200	F11994-011
12 kV 1-core outdoor terminations for polymeric cables		
OXSU-F 3111	10 – 35	921513-011
OXSU-F 3121	25 – 95	674179-011
OXSU-F 3131	95 – 240	170347-011
OXSU-F 3141	240 – 500	572329-011
OXSU-F 3151	500 – 800	057101-011
OXSU-F 3161	1000 – 1200	A25232-011
12 kV 3-core indoor terminations for polymeric cables		
IXSU-F 3301	10 – 16	042899-011
IXSU-F 3311	16 – 35	609815-011
IXSU-F 3314	16 – 35	492379-000
IXSU-F 3321	25 – 70	975845-011
IXSU-F 3324	25 – 70	186727-011
IXSU-F 3331	95 – 240	931779-011
IXSU-F 3334	95 – 240	843829-011
IXSU-F 3341	240 – 500	681745-011
IXSU-F 3344	240 – 500	278157-011
12 kV 3-core outdoor terminations for polymeric cables		
OXSU-F 3311	16 – 35	648313-000
OXSU-F 3314	16 – 35	652785-000
OXSU-F 3321	25 – 70	924109-000
OXSU-F 3324	25 – 70	462641-011
OXSU-F 3331	95 – 240	114825-011
OXSU-F 3334	95 – 240	447699-000
OXSU-F 3341	240 – 500	619691-000



IXSU/OXSU

Raychem Medium Voltage Heat-shrink Zinc Oxide Stress Control Terminations up to 24 kV

FEATURES

- Universal termination family for 24 kV based on unique Raychem zinc oxide stress control technology
- Red co-extruded non-tracking Raychem zinc oxide HVOT tubing provides excellent environmental protection
- Compact design
- Conductive break-out and CNTM core extension tubes allow crossing of cores

APPLICATIONS

- All applications for polymeric 1-core, 3-core, armoured and unarmoured cables
- Can be used in combination with Raychem RICS / RCAB / RSRB switchgear connection systems

CONFORMS TO

- Tested in accordance to CENELEC HD.629.1.S2:2006, IEC 60502-4 and IEEE 48

Raychem Medium Voltage Heat-shrink Zinc Oxide Stress Control Terminations up to 24 kV

Product name	Conductor size (mm ²)	Part number
24 kV 1-core indoor terminations for polymeric cables		
IXSU-F 5121	25 – 70	552897-011
IXSU-F 5131	70 – 240	086833-011
IXSU-F 5141	185 – 400	675377-011
IXSU-F 5151	400 – 800	000877-011
IXSU-F 5161	1000 – 1200	F01490-011
24 kV 1-core outdoor terminations for polymeric cables		
OXSU-F 5121	25 – 70	294997-011
OXSU-F 5131	70 – 240	403451-011
OXSU-F 5141	185 – 400	529965-011
OXSU-F 5151	400 – 800	074061-011
OXSU-F 5161	1000 – 1200	C26806-011
24 kV 3-core indoor terminations for polymeric cables		
IXSU-F 5311	10 – 25	421400-011
IXSU-F 5321	25 – 50	971921-011
IXSU-F 5324	25 – 50	197315-011
IXSU-F 5331	70 – 185	454059-011
IXSU-F 5334	70 – 185	613651-011
IXSU-F 5341	185 – 400	486669-011
IXSU-F 5344	185 – 400	604505-011
24 kV 3-core outdoor terminations for polymeric cables		
OXSU-F 5311	10 – 25	407304-011
OXSU-F 5314	10 – 25	401520-011
OXSU-F 5321	25 – 50	911909-000
OXSU-F 5324	25 – 50	893465-000
OXSU-F 5331	70 – 185	381949-011
OXSU-F 5334	70 – 185	442835-000
OXSU-F 5341	185 – 400	047705-011
OXSU-F 5344	185 – 400	535683-000

EPKJ

Raychem Medium Voltage Heat Shrink Cable Joints up to 17.5 kV

FEATURES

- Pre-engineered range taking heat-shrinkable tubings incorporating precisely engineered impedance stress control. EPKJ universal joints are suitable for a wide range of connectors and cable sizes with no limitations on shelf life

APPLICATIONS

- Suitable for polymeric, rubber and paper insulated MIND cables single and three core, armoured and non-armoured

CONFORMS TO

- CENELEC and IEC standards

Raychem medium voltage heat shrink cable joints up to 17.5 kV



Product name	Conductor size (mm ²)	Part number
XLPE TO XLPE		
Single core to three core		
EPKJ-17A/1XU-3XU	35 – 70	611905-011
EPKJ-17B/1XU-3XU	95 – 185	591811-011
EPKJ-17C/1XU-3XU	240 – 400	961580-011
Three core to three core		
EPKJ-17A/3XU-3XU	35 – 70	345116-011
EPKJ-17B/3XU-3XU	95 – 185	765410-011
EPKJ-17C/3XU-3XU	240 – 400	251291-011
Three core to three core armoured		
EPKJ-17A/3XU-3XU-W	35 – 70*	863732-011
EPKJ-17B/3XU-3XU-W	95 – 185*	467470-011
EPKJ-17C/3XU-3XU-W	240 – 400*	678746-011
XLPE to paper insulated lead covered single core		
EPKJ-17A/1XU-1HL	35 – 70	042316-011
EPKJ-17B/1XU-1HL	95 – 185	361308-011
EPKJ-17C/1XU-1HL	240 – 400	634912-011
EPKJ-17D/1XU-1HL	500 – 630	813649-011
Paper insulated lead covered single core		
EPKJ-17C/1HL-1HL	240 – 400	885779-011
EPKJ-17D/1HL-1HL	500 – 630	292748-011
XLPE to paper insulated lead covered 3-core unarmoured		
EPKJ-17A/3XU-3SB	35 – 70	179240-000
EPKJ-17B/3XU-3SB	95 – 185	226574-011
EPKJ-17C/3XU-3SB	240 – 400	545967-011
XLPE to paper insulated lead sheathed 3-core armoured		
EPKJ-17A/3XU-3SB-W	25 – 50	116472-011
EPKJ-17B/3XU-3SB-W	70 – 150	351372-011
EPKJ-17C/3XU-3SB-W	185 – 300	984248-011
Paper insulated lead sheathed 3-core armoured		
EPKJ-17A/3SB-3SB-W	25 – 50	144086-011
EPKJ-17B/3SB-3SB-W	70 – 150	098379-011
EPKJ-17C/3SB-3SB-W	185 – 300	114577-011
XLPE single core to paper insulated lead sheathed 3-core		
EPKJ-17B/1XU-3HL	95 – 185	635241-011
XLPE single core to paper insulated lead sheathed 3-core		
EPKJ-17A/1XU-3SB	35 – 70	652371-011
EPKJ-17B/1XU-3SB	95 – 185	650316-011
EPKJ-17C/1XU-3SB	240 – 400	747518-011
EPKJ-17D/1XU-3SB	500 – 630	098464-000

NOTE SB for 3-core paper cables (screened or belted) with overall metal sheath. HL for paper cables with lead sheath on each core. Where possible use MXSU and MXSW product.

EPKJ

Raychem Medium Voltage Heat Shrink Cable Joints up to 24 kV

FEATURES

- Pre-engineered range taking heat-shrinkable tubings incorporating precisely engineered impedance stress control. EPKJ universal joints are suitable for a wide range of connectors and cable sizes with no limitations on shelf life

APPLICATIONS

- Suitable for polymeric, rubber and paper insulated MIND cables
- Single and three core, armoured and non-armoured

CONFORMS TO

- CENELEC and IEC standards

Raychem medium voltage heat shrink cable joints up to 24 kV



Product name	Conductor size (mm ²)	Part number
XLPE TO XLPE		
EPKJ-24D/1XU-3XU	300 – 400	858656-011
EPKJ-24D/3XU-3XU	300 – 400	209513-011
EPKJ-24B/3XU- 3XU-W	35 – 70	961281-011
EPKJ-24C/3XU- 3XU-W	95 – 240	741682-011
EPKJ-24D/3XU- 3XU-W	300 – 400	425444-011
XLPE to paper insulated lead covered single core		
EPKJ-24B/1XU-1HL	35 – 70	533966-000
EPKJ-24C/1XU-1HL	95 – 240	110743-011
EPKJ-24D/1XU-1HL	300 – 400	818203-011
Paper insulated lead covered single core		
EPKJ-24B/1HL-1HL	35 – 70	712089-000
EPKJ-24C/1HL-1HL	95 – 240	122185-011
EPKJ-24D/1HL-1HL	300 – 400	861101-000
XLPE to paper insulated lead sheathed 3-core unarmoured		
EPKJ-24C/3XU-3SB	95 – 240	013208-011
XLPE to paper insulated lead sheathed 3-core armoured		
EPKJ-24C/3XU- 3SB-W	95 – 240	600096-011
XLPE to paper insulated lead covered 3-core unarmoured.		
EPKJ-24C/3XU-3HL	95 – 240	634461-011
EPKJ-24D/3XU-3HL	300 – 400	736647-011
XLPE single core to paper insulated lead sheathed 3-core		
EPKJ-24A/1XU-3SB	25	655611-000
EPKJ-24B/1XU-3SB	35 – 70	866971-011
EPKJ-24C/1XU-3SB	95 – 240	972354-011
EPKJ-24D/1XU-3SB	300 – 400	025566-011
XLPE single core to paper insulated lead sheathed 3-core		
EPKJ-24B/1XU-3HL	35 – 70	026840-000
EPKJ-24C/1XU-3HL	95 – 240	861100-011
EPKJ-24D/1XU-3HL	300 – 400	338149-000

NOTE SB for 3-core paper cables (screened or belted) with overall metal sheath.
HL for paper cables with lead sheath on each core.
Where possible use MXSU and MXSW product.

EPKJ

Raychem Medium Voltage Heat Shrink Cable Joints up to 36 kV

FEATURES

- Pre-engineered range taking heat-shrinkable tubings incorporating precisely engineered impedance stress control. EPKJ universal joints are suitable for a wide range of connectors and cable sizes with no limitations on shelf life

APPLICATIONS

- Suitable for polymeric, rubber and paper insulated MIND cables single and three core, armoured and non-armoured

CONFORMS TO

- CENELEC and IEC standards

Raychem medium voltage heat shrink cable joints up to 36 kV



Product name	Conductor size (mm ²)	Part number
XLPE TO XLPE		
EPKJ-36A/1XU-1XU	50 – 70	116908-011
EPKJ-36B/1XU-1XU	95 – 150	407944-011
EPKJ-36C/1XU-1XU	185 – 400	682466-011
EPKJ-36D/1XU-1XU	500 – 630	698309-011
EPKJ-36A/3XU- 3XU-W	50 – 70	653639-011
EPKJ-36B/3XU- 3XU-W	95 – 150	245043-011
EPKJ-36C/3XU- 3XU-W	185 – 400	868075-011
XLPE to paper insulated lead covered single core		
EPKJ-36A/1XU-1HL	50 – 70	933038-011
EPKJ-36B/1XU-1HL	95 – 150	093715-011
EPKJ-36C/1XU-1HL	185 – 400	697197-011
EPKJ-36D/1XU-1HL	500 – 630	291626-011
SMOE-64222	500 poly to 1000 mm ²	CS9849-011
Paper insulated lead covered single core		
EPKJ-36B/1HL-1HL	95 – 150	093715-011
EPKJ-36C/1HL-1HL	185 – 400	105526-011
EPKJ-36D/1HL-1HL	500 – 630	928072-011
XLPE to paper insulated lead sheathed 3-core armoured		
EPKJ-36C/3XU- 3SB-W-GB01	185 – 240	CU8132-011
EPKJ-36B/3SB- 3SB-W	95 – 150	267335-000
EPKJ-36C/3SB- 3SB-W	185 – 400	012579-011
XLPE single core to paper insulated lead sheathed 3-core		
EPKJ-36A/1XU-3HL	50 – 70	756137-000
EPKJ-36B/1XU-3HL	95 – 150	018099-011
EPKJ-36C/1XU-3HL	185 – 400	021838-011
XLPE single core to paper insulated lead sheathed 3-core		
EPKJ-36A/1XU-3SB	50 – 70	348453-000
EPKJ-36B/1XU-3SB	95 – 185	016746-011
EPKJ-36C/1XU-3SB	185 – 400	815876-011

EPKJ

Joint selection chart - choose one figure from the left hand column of each table

Typical part number: EPKJ					
	17	C	3XU	3SB	-W
Voltage class					
17	11 – 17.5 kV				
24	22 kV				
36	33 kV				
Size in mm²					
	11 kV	17.5 kV	22 kV	33 kV*	
A	35 – 70	25 – 50	25	50 – 70	
B	95 – 185	70 – 150	35 – 70	95 – 150	
C	240 – 400	185 – 300	95 – 240	185 – 400	
D	500 – 630	400 – 500	300 – 400	500 – 630	
Cable 1					
No. of cores					
1	for single-core cables				
3	for 3-core cables				
Insulation type					
XU	for polymeric (EPR or XLPE)				
HL	for paper cables with lead sheath on each core				
SB	for 3-core paper cables (screened or belted) with overall metal sheath				
Cable 2					
No. of cores					
1	for single-core cables				
3	for 3-core cables				
Insulation type					
XU	for polymeric (EPR or XLPE)				
HL	for paper cables with lead sheath on each core				
SB	for 3-core paper cables (screened or belted) with overall metal sheath				
Armour**					
W	only to be used with 3c - 3c SWA cables				

* For 6.6 kV or 33 kV joint selection, contact your TE specialist distributor or your local TE office.

** For single-core aluminium wire armoured cables, armour kit SMOE 61293 is required in addition to the joint kit.

Voltage
Cable size
Insulation - Cable 1
Insulation - Cable 2
Armour

MXSU/MXST/MXSW/MXAW

Joint up to 36 kV with Mechanical Connectors

FEATURES

- Pre-engineered range taking heat-shrinkable tubings incorporating precisely engineered impedance stress control; MXSU/MXST/MXSW/MXAW joints are supplied complete with mechanical phase and screen connectors suitable for a wide range of conductor sizes with no limitations on shelf life

APPLICATIONS

- Suitable for polymeric 1-core, 3-core, armoured and unarmoured cables

BENEFITS

- Tested in accordance to CENELEC and IEC standards

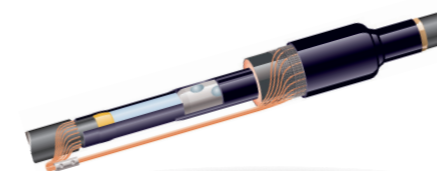

SELECTION INFORMATION: DIMENSIONS SHOWN IN MILLIMETERS

Inline joint for 3 core poly cables with copper wire shield, without armour

Mechanical Connectors included	12 kV	24 kV	Diameter Conductor	Diameter over Core insulation	Diameter Cable Over sheath
MXSU-3311	25-95	-	5.2 - 12.0 mm	13.2 - 21.8 mm	40 - 61 mm
MXSU-3321	70-150	-	8.7 - 15.0 mm	17.6 - 24.3 mm	45 - 68 mm
MXSU-3331	95-240	-	10.3 - 19.2 mm	18.5 - 29.4 mm	53 - 77 mm
MXSU-3332	150-300	-	12.9 - 21.6 mm	21.6 - 31.4 mm	59 - 85 mm
MXSU-5311	-	25-95	5.2 - 12.0 mm	17.9 - 26.0 mm	48 - 72 mm
MXSU-5321	-	50-150	7.2 - 15.0 mm	20.2 - 29.5 mm	55 - 80 mm
MXSU-5331	-	95-240	10.3 - 19.2 mm	23.0 - 33.6 mm	62 - 89 mm
MXSU-5332	-	150-300	12.9 - 21.6 mm	25.0 - 35.5 mm	70 - 96 mm

Inline joint for 3 core poly cables with copper wire shield, and steel tape armour

Mechanical Connectors included	12 kV	24 kV	Diameter Conductor	Diameter over Core insulation	Diameter Cable Over sheath
MXST-3331	95-240	-	10.3 - 19.2 mm	17.6 - 29.4 mm	60 - 80 mm
MXST-3332	150-300	-	12.9 - 21.6 mm	22.0 - 31.4 mm	64 - 85 mm
MXST-5331	-	95-240	10.3 - 19.2 mm	23.0 - 33.6 mm	70 - 90 mm
MXST-5332	-	150-300	12.9 - 21.6 mm	25.0 - 35.5 mm	76 - 95 mm

Inline joint for 3 core poly cables with copper tape shield and steel wire armour

Mechanical Connectors included	12 kV	24 kV	Diameter Conductor	Diameter over Core insulation	Diameter Cable Over sheath
MXSW-3331	95-240	-	10.3 - 19.2 mm	17.6 - 29.4 mm	60 - 80 mm
MXSW-3332	150-300	-	12.9 - 21.6 mm	22.0 - 31.4 mm	64 - 85 mm
MXSW-5331	-	95-240	10.3 - 19.2 mm	23.0 - 33.6 mm	70 - 90 mm
MXSW-5332	-	150-300	12.9 - 21.6 mm	25.0 - 35.5 mm	76 - 95 mm

Note: For any other cable construction, please contact your local sales representative

Inline joint for 1 core poly cables with copper wire shield without armour

Mechanical Connectors included	12 kV	24 kV	36 kV	Diameter Conductor	Diameter over Core insulation	Diameter Cable Over sheath
MXSU-3111	25-95	-	-	5.2 - 12.0 mm	13.2 - 21.8 mm	23 - 32 mm
MXSU-3121	70-150	-	-	8.7 - 15.0 mm	17.6 - 24.3 mm	25 - 38 mm
MXSU-3131	95-240	-	-	10.3 - 19.2 mm	17.6 - 29.4 mm	26 - 40 mm
MXSU-3132	150-300	-	-	12.9 - 21.6 mm	21.6 - 30.4 mm	29 - 43 mm
MXSU-3141	240-400	-	-	17.8 - 24.6 mm	25.7 - 32.6 mm	33 - 47 mm
MXSU-3151	500	-	-	25.5 - 27.6 mm	33.8 - 37.2 mm	44 - 50 mm
MXSU-3161	630	-	-	29.0 - 32.5 mm	37.5 - 40.0 mm	47 - 54 mm
MXSU-3171	800	-	-	32.0 - 33.8 mm	39.5 - 42.6 mm	52 - 57 mm
MXSU-3181	1000	-	-	38.5 - 39.2 mm	45.0 - 47.6 mm	59 - 64 mm
MXSU-5101	-	oct-35	-	3.7 - 7.5 mm	15.0 - 22.0 mm	17 - 33 mm
MXSU-5111	-	25-95	-	5.2 - 12.0 mm	17.9 - 26.0 mm	25 - 38 mm
MXSU-5121	-	50-150	-	7.2 - 15.0 mm	20.2 - 29.5 mm	28 - 38 mm
MXSU-5131	-	95-240	-	10.3 - 19.2 mm	23.0 - 33.6 mm	30 - 43 mm
MXSU-5132	-	150-300	-	12.9 - 21.6 mm	25.0 - 35.5 mm	33 - 48 mm
MXSU-5141	-	240-400	-	17.8 - 24.6 mm	29.9 - 38.8 mm	35 - 49 mm
MXSU-5151	-	500	-	25.5 - 27.6 mm	37.2 - 41.6 mm	48 - 54 mm
MXSU-5161	-	630	-	29.0 - 32.5 mm	39.2 - 44.7 mm	50 - 58 mm
MXSU-5171	-	800	-	32.0 - 33.8 mm	44.8 - 46.9 mm	58 - 61 mm
MXSU-5181	-	1000	-	38.5 - 39.2 mm	49.4 - 53.2 mm	64 - 67 mm
MXSU-6111	-	-	35-95	6.0 - 12.0 mm	24.0 - 30.0 mm	32 - 43 mm
MXSU-6121	-	-	70-150	8.7 - 15.0 mm	26.2 - 34.5 mm	34 - 44 mm
MXSU-6131	-	-	150-300	13.9 - 21.6 mm	31.1 - 39.6 mm	38 - 53 mm
MXSU-6141	-	-	240-400	17.8 - 24.6 mm	36.2 - 42.8 mm	40 - 54 mm
MXSU-6151	-	-	500	25.5 - 29.2 mm	40.1 - 46.6 mm	52 - 60 mm
MXSU-6161	-	-	630	29.0 - 32.5 mm	45.8 - 50.5 mm	55 - 68 mm
MXSU-6171	-	-	800	32.0 - 33.8 mm	50.1 - 53.4 mm	62 - 66 mm
MXSU-6181	-	-	1000	38.5 - 39.2 mm	55.7 - 58.8 mm	69 - 73 mm

Note: For armoured and tape shield cables, please contact your local sales representative

Inline joint for 1 core poly cables with copper wire or tape shield with aluminium wire armour

Mechanical Connectors included	24 kV	Diameter Conductor	Diameter over Core insulation	Diameter Cable Over sheath
MXAW-5131	95-185	10.3 - 17.6 mm	23.0 - 31.2 mm	37 - 43 mm
MXAW-5132	150-300	12.9 - 21.6 mm	25.8 - 34.6 mm	40 - 48 mm
MXAW-5141	240-400	17.8 - 24.6 mm	29.4 - 38.8 mm	44 - 54 mm
MXAW-5151	500	25.5 - 27.6 mm	37.2 - 41.6 mm	48 - 56 mm
MXAW-5161	630	29.0 - 32.5 mm	39.2 - 44.7 mm	50 - 60 mm

Note: For cable constructions or voltages not listed, please contact your local sales representative

SXSU/SXST/SXSW/SXAW

Joints for Polymeric Insulated Cables from 12 kV up to 36 kV

FEATURES

- Pre-engineered, range taking and heat-shrinkable tubings which incorporate precisely engineered impedance stress control;
- SXSU/SXST/SXSW/SXAW joints are suitable for a wide range of conductor sizes with no limitations on shelf life

APPLICATIONS

- Suitable for polymeric 1-core, 3-core, armoured and unarmoured cables

BENEFITS

- Tested in accordance to CENELEC and IEC standards



SELECTION INFORMATION: DIMENSIONS SHOWN IN MILLIMETERS

Inline joint for 1-core polymeric cables with copper wire shield, without armour

Kit Number	12 kV	24 kV	36 kV	Diameter over Core insulation	Diameter Cable oversheath	Connector dimensions max. diameter/max.length
SXSU-3111	35-70	-	-	15.4 - 20.2 mm	23 - 29 mm	23 mm / 110 mm
SXSU-3121	95-185	-	-	17.6 - 26.9 mm	25 - 37 mm	29 mm / 160 mm
SXSU-3131	185-300	-	-	22.0 - 31.4 mm	29 - 43 mm	34 mm / 180 mm
SXSU-3141	300-500	-	-	28.4 - 38.8 mm	36 - 52 mm	44 mm / 220 mm
SXSU-4111	50-70	-	-	15.4 - 20.2 mm	23 - 29 mm	22 mm / 110 mm
SXSU-4121	95-185	-	-	17.6 - 26.9 mm	25 - 37 mm	29 mm / 160 mm
SXSU-4131	185-300	-	-	23.2 - 31.4 mm	29 - 43 mm	36 mm / 180 mm
SXSU-4141	400-630	-	-	29.8 - 42.5 mm	40 - 52 mm	52 mm / 250 mm
SXSU-4151	800-1200	-	-	39.4 - 50.0 mm	48 - 66 mm	62mm / 280 mm
SXSU-5121	-	25-95	-	17.6 - 26.0 mm	25 - 37 mm	23 mm / 120 mm
SXSU-5131	-	95-240	-	23.2 - 33.6 mm	28 - 44 mm	34 mm / 140 mm
SXSU-5141	-	240-500	-	29.8 - 41.6 mm	33 - 52 mm	44 mm / 230 mm
SXSU-5151	-	630-800	-	39.4 - 48.0 mm	48 - 66 mm	58 mm / 250 mm
SXSU-5161	-	1000-1200	-	49.4 - 56.2 mm	55 - 75 mm	62 mm / 280 mm
SXSU-6121	-	-	35-95	24.0 - 31.4 mm	32 - 41 mm	22 mm / 140 mm
SXSU-6131	-	-	95-150	26.4 - 34.4 mm	35 - 46 mm	29 mm / 160 mm
SXSU-6141	-	-	185-400	31.9 - 43.7 mm	40 - 54 mm	42 mm / 220 mm
SXSU-6151	-	-	500-800	42.9 - 53.4 mm	55 - 66 mm	58 mm / 250 mm
SXSU-6161	-	-	800-1200	46.2 - 61.5 mm	55 - 73 mm	62 mm / 280 mm
SXSU-6122	-	-	35-150	24.0 - 34.4 mm	33 - 44 mm	29 mm / 160 mm
SXSU-6132	-	-	150-300	30.8 - 40.5 mm	36 - 52 mm	38 mm / 160 mm
SXSU-6142	-	-	400-630	40.1 - 50.5 mm	40 - 62 mm	52 mm / 250 mm
SXSU-6152	-	-	800-1200	45.6 - 61.5 mm	55 - 76 mm	62 mm / 280 mm

Note: For copper tape shield or armoured cables, please contact your local sales representative.

Inline joint for 3-core polymeric cables with copper wire shield, without armour

Kit Number	12 kV	24 kV	36 kV	Diameter over Core insulation	Diameter Cable oversheath	Connector dimensions max. diameter/max.length
SXSU-3311	35-70	-	-	15,4 - 20,2 mm	40 - 57 mm	23 mm / 110 mm
SXSU-3321	95-185	-	-	17,6 - 26,9 mm	53 - 73 mm	29 mm / 160 mm
SXSU-3331	185-300	-	-	22,0 - 31,4 mm	63 - 82 mm	34 mm / 180 mm
SXSU-4302	16-35	-	-	13,2 - 17,3 mm	38 - 49 mm	17 mm / 100 mm
SXSU-4312	50-70	-	-	15,4 - 20,2 mm	46 - 57 mm	22 mm / 110 mm
SXSU-4322	95-185	-	-	17,6 - 26,9 mm	53 - 73 mm	29 mm / 160 mm
SXSU-4332	185-300	-	-	23,2 - 31,4 mm	63 - 82 mm	36 mm / 180 mm
SXSU-5322	-	25-95	-	17,6 - 26,0 mm	48 - 72 mm	23 mm / 120 mm
SXSU-5332	-	95-240	-	23,2 - 33,6 mm	62 - 89 mm	34 mm / 140 mm
SXSU-5342	-	240-500	-	29,8 - 41,6 mm	78 - 100 mm	44 mm / 230 mm

Note: For copper tape shield or armoured cables, please contact your local sales representative.

Inline joint for 3-core polymeric cables with copper wire shield and steel tape armour

Kit Number	12kV	Diameter over Core insulation	Diameter Cable oversheath	Connector dimensions max. diameter/max.length
SXST-4303	16-35	13,2-17,3 mm	38-52 mm	17 mm/ 100 mm
SXST-4313	50-70	15,4-20,2 mm	48-57 mm	22 mm/ 110 mm
SXST-4323	95-185	17,6-26,9 mm	56-73 mm	29 mm/ 160 mm
SXST-4333	185-300	23,2-31,4 mm	68-84 mm	36 mm/ 180 mm

Note: For tape shield cables, please contact your local sales representative.

Inline joint for 3-core polymeric cables with copper wire shield and steel wire armour

Kit Number	12kV	Diameter over Core insulation	Diameter Cable oversheath	Connector dimensions max. diameter/max.length
SXSW-4304	16-35	13,2-17,3 mm	38-54 mm	17 mm/ 100 mm
SXSW-4314	50-70	15,4-20,2 mm	48-60 mm	22 mm/ 110 mm
SXSW-4324	95-185	17,6-26,9 mm	56-75 mm	29 mm/ 160 mm
SXSW-4334	185-300	23,2-31,4 mm	68-86 mm	36 mm/ 180 mm

Note: For copper tape shield cables, please contact your local sales representative.

Inline joint for 1-core polymeric cables with aluminium wire armour

Kit Number	12 kV	24 kV	36 kV	Diameter over Core insulation	Diameter Cable oversheath	Connector dimensions max. diameter/max.length
SXAW-3121	95-185	-	-	17,6 - 26,9 mm	28 - 39 mm	28,5 mm / 140 mm
SXAW-3131	185-300	-	-	22,0 - 31,4 mm	33 - 45 mm	34 mm / 180 mm
SXAW-3141	400-500	-	-	28,4 - 38,8 mm	40 - 52 mm	44 mm / 220 mm
SXAW-3151	630-800	-	-	39,4 - 45,5 mm	53 - 59 mm	58 mm / 250 mm
SXAW-5121	-	50-95	-	17,6 - 26,0 mm	28 - 39 mm	23 mm / 120 mm
SXAW-5131	-	120-185	-	23,2 - 33,6 mm	33 - 44 mm	28,5 mm / 140 mm
SXAW-5141	-	240-400	-	29,8 - 38,8 mm	40 - 54 mm	38,5 mm / 220 mm
SXAW-5151	-	500-630	-	39,4 - 45,0 mm	54 - 64 mm	52 mm / 250 mm
SXAW-6122	-	-	50-95	24,0 - 31,4 mm	33 - 44 mm	23 mm / 120 mm
SXAW-6132	-	-	120-240	30,8 - 40,5 mm	44 - 54 mm	32 mm / 160 mm
SXAW-6142	-	-	300-630	40,1 - 50,5 mm	54 - 68 mm	52 mm / 250 mm

Note: For tape shield cables, please contact your local sales representative.

RICS

Raychem Insulated Adapter Termination System RICS for SF6-insulated Switchgear up to 24 kV

FEATURES

- Angled insulated adapter made of rubber, which does not require heat during installation
- The body and the termination are not shielded. During operation, all parts are considered to be live and must not be touched

APPLICATIONS

- For round and sector-shaped polymeric insulated single and 3-core cables
- Used in conjunction with termination type IXSU-F and EPKT
- Disconnection of the body is only permitted when power has been turned off
- Only for compression lugs (not included)

CONFORMS TO

- Tested in accordance to CENELEC HD.629.1.S2:2006, IEC 60502-4 and IEEE 48

RICS

Product name	Rated voltage kV	Cross-section mm ²	Part number
RICS-3133	12	70 – 300	CM2361-000
RICS-5123	24	25 – 70	555340-000
RICS-5133	24	95 – 185	753072-000
RICS-5143	24	240 – 300	892434-000

Note: For application information please contact technical services.

RCAB

Raychem Elastomeric Insulating Bushing Boot RCAB for Bushings up to 17.5 kV and 24 kV

FEATURES

- Tool free application
- High-performance insulation material
- Excellent track and erosion resistance
- Removable and reinstallable
- Connection can be energised immediately after installation

APPLICATIONS

- Indoor application
- Used to improve air clearance in cable boxes to improve phase-to-phase and phase-to-ground insulation

CONFORMS TO

- Tested in accordance to CENELEC HD.629.1

RCAB Application range

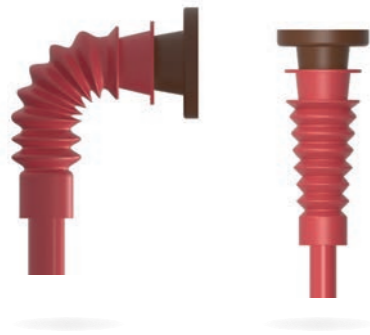

Product name	Bushing diameter (mm)	Part number
SMOE-62804	31 – 45	605557N001
SMOE-62803	46 – 70	894919N001

Bushing lug for termination



Universal screw
EXRM-1366

Product name	Bushing diameter (mm)	Part number
EXRM 1366	Bushing lug	527427N001

Min. dimension phase/earth and phase/phase for RCAB

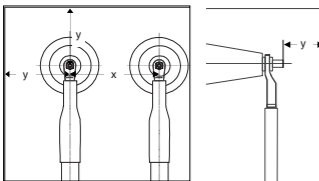

Um (kV)	7.2	12	17.5
Min. clearance between live metal x (mm)	100	100	100
Min. clearance between live metal and ground y (mm)	60	60	75
Min. clearance between boots (mm)	12	12	12

CSJT

Cold-shrink Joint with Resin Injection for XLPE Cables up to 36 kV

FEATURES

- The tape and resin outer sealing and protection system provides a reliable moisture seal, corrosion prevention and effective impact resistance;
- Pre-expanded, single piece silicone rubber joint body with high mechanical expansion capability allows a wide application range;
- Electrical stress control of the screen cut area by integrated conductive geometrical stress cones;
- Electrical stress control of the connector area by an integrated screened connection area (Farada cage)

APPLICATIONS

- Suitable for polymeric armoured and unarmoured cables;
- Hard-elastic polyurethane-type re-jacketing with excellent insulation properties, hydrolytic stability and hydrophobic characteristics for underground applications

BENEFITS

- Tested in accordance to CENELEC and IEC standards

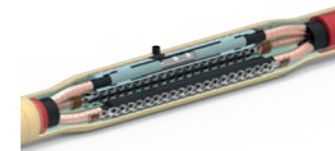

24 kV three core cable Joint

Cross-section (mm ²)	Kit description	Application range of diameter over insulation (mm)
35-150	CSJT-24B/3XU-3XU	18.6 - 28.0
120-300	CSJT-24C/3XU-3XU	23.0 - 34.6
400-500	CSJT-24E/3XU-3XU	33.8 - 50.0

24 kV single core cable Joint

Cross-section (mm ²)	Kit description	Application range of diameter over insulation (mm)	Maximum diameter over outer sheath (mm)
35-95	CSJT-24B/1XU-1XU	18.6 - 28.0	40
120-240	CSJT-24C/1XU-1XU	23.0 - 34.0	47
300-400	CSJT-24D/1XU-1XU	25.7 - 38.0	54
500-630	CSJT-24E/1XU-1XU	33.8 - 50.0	65
800-1000	CSJT-24F/1XU-1XU	40.5 - 60.0	73

36 kV three core cable Joint

Cross-section (mm ²)	Kit description	Application range of diameter over insulation (mm)
50-70	CSJT-36C/3XU-3XU	23.0 - 34.0
95-240	CSJT-36D/3XU-3XU	25.7 - 38.0
300-500	CSJT-36E/3XU-3XU	33.8 - 50.0

36 kV single core cable Joint

Cross-section (mm ²)	Kit description	Application range of diameter over insulation (mm)	Maximum diameter over outer sheath (mm)
50-70	CSJT-36C/1XU-1XU	23.0 - 34.0	47
95-240	CSJT-36D/1XU-1XU	25.7 - 38.0	54
300-500	CSJT-36E/1XU-1XU	33.8 - 50.0	65
630-1000	CSJT-36F/1XU-1XU	40.5 - 60.0	73

The application range given in the table is based on polymeric insulated cable according to IEC 60502 standard with stranded circular conductors. Due to different conductor sharp or dimensions and cable constructions the minimum and maximum application range may be extendable. Please contact your local sales representative.

CSTI/CSTO

Cold-shrink Termination with Integrated Stress Control for XLPE Cables up to 24 kV

FEATURES

- Pre-expanded termination body with integrated stress control;
- The extra-long silicone stress cone is integrated with the termination and reduces positioning switchgear connection systems;
- Accommodates mechanical lug and compression lug

APPLICATIONS

- Suitable for indoor and outdoor use; 25 - 630 mm² conductor size

BENEFITS

- Tested in accordance to CENELEC
- HD.629.1.S2:2006, IEC 60502-4 and IEEE 48

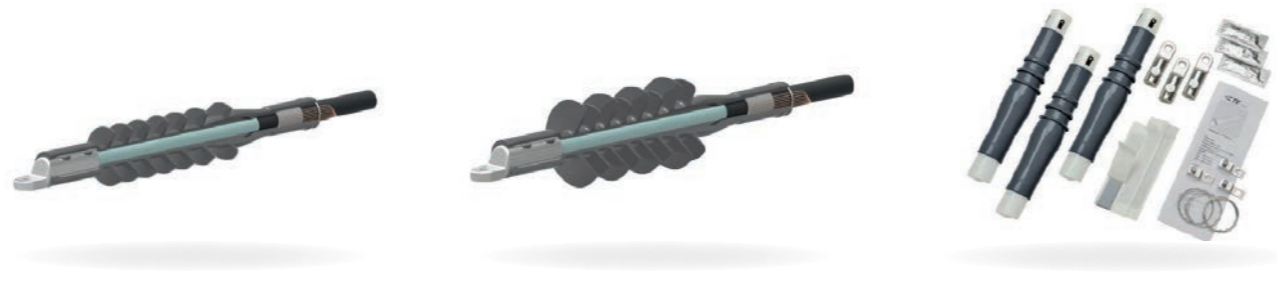

Technical data

Voltage class	(kV)	6.35/11(12)	8.7/15(17.5)	12.7/22(24)
Cable insulation diameter	(mm)	13.7 – 40.0	15.7 – 50.0	17.9 – 52.0
Cross section range	(mm ²)	25 – 630	25 – 630	25 – 630
Max system voltage Um	(kV)	12	17.5	24
Basic impulse level	(kV)	95	95	125
Partial discharge at 2 U ₀	(pC)	<10	<10	<10
AC Voltage withstand, 5 min	(kV)	28.5	39	57

SELECTION INFORMATION: DIMENSIONS IN INCHES/FEET (MILLIMETERS/METERS)

12 kV 3-Core cable

Cross-section (mm ²)	Kit description	Diameter over insulation (mm)	Comment
Indoor-termination			
25-50	CSTI-12-2550-T	11.7 - 18	Tape shielded
70-120	CSTI-12-7012-T	16.9 - 26	Tape shielded
150-185	CSTI-12-1518-T	16.9 - 26	Tape shielded
240-400	CSTI-12-2440-T	24.7 - 38	Tape shielded
500	CSTI-12-500-T	32.5 - 50	Tape shielded
Outdoor-termination			
25-50	CSTO-12-2550-T	11.7 - 18	Tape shielded
70-120	CSTO-12-7012-T	16.9 - 26	Tape shielded
150-185	CSTO-12-1518-T	16.9 - 26	Tape shielded
240-400	CSTO-12-2440-T	24.7 - 38	Tape shielded
500	CSTO-12-500-T	32.5 - 50	Tape shielded

12 kV 1-Core cable

Cross-section (mm ²)	Kit description	Diameter over insulation (mm)	Comment
Indoor termination			
70-185	CSTI-12-7018-SC-T	16.9-26	Tape shielded, unarmored
240-400	CSTI-12-2440-SC-T	24.7-38	Tape shielded, unarmored
500-630	CSTI-12-5063-SC-T	32.5-50	Tape shielded, unarmored
Outdoor termination			
70-185	CSTO-12-7018-SC-T	16.9-26	Tape shielded, unarmored
240-400	CSTO-12-2440-SC-T	24.7-38	Tape shielded, unarmored
500-630	CSTO-12-5063-SC-T	32.5-50	Tape shielded, unarmored

24 kV 3-Core cable

Cross-section (mm ²)	Kit description	Diameter over insulation (mm)	Comment
Indoor termination			
35-95	CSTI-24-3595-T	16.9-26	Tape shielded
120-185	CSTI-24-1218-T	24.7-38	Tape shielded
240-300	CSTI-24-2430-T	24.7-38	Tape shielded
400	CSTI-24-400-T	24.7-38	Tape shielded
Outdoor termination			
35-95	CSTO-24-3595-T	16.9-26	Tape shielded
120-185	CSTO-24-1218-T	24.7-38	Tape shielded
240-300	CSTO-24-2430-T	24.7-38	Tape shielded
400	CSTO-24-400-T	24.7-38	Tape shielded

24 kV 1-Core cable

Cross-section (mm ²)	Kit description	Diameter over insulation (mm)	Comment
Indoor termination			
35-95	CSTI-24-3595-SC-T	16.9-26	Tape shielded, unarmored
120-185	CSTI-24-1218-SC-T	24.7-38	Tape shielded, unarmored
240-300	CSTI-24-2430-SC-T	24.7-38	Tape shielded, unarmored
400	CSTI-24-4063-SC-T	32.5-50	Tape shielded, unarmored
Outdoor termination			
35-95	CSTO-24-3595-SC-T	16.9-26	Tape shielded, unarmored
120-185	CSTO-24-1218-SC-T	24.7-38	Tape shielded, unarmored
240-300	CSTO-24-2430-SC-T	24.7-38	Tape shielded, unarmored
400	CSTO-24-4063-SC-T	32.5-50	Tape shielded, unarmored

The application range given in the table is based on polymeric insulated cable according to IEC 60502 standard with stranded circular conductors. Due to different conductor shape or dimensions and cable constructions the minimum and maximum application range may be extendable. Please contact your local sales representative.

ELBC 810

Screened Separable Connector up to 12 kV, 800 A

FEATURES

- ELBC screened separable connectors are made of high modified EPDM rubber which ensures the high dielectric strength and elongation at break;
- A thick conductive EPDM jacket protects the connection system against unintentional contact;
- Unique design makes it fully shielded and submersible when matched with the right bushing or plug;
- Easily accessible back plug with capacitive test point

APPLICATIONS

- ELBC is designed to fit 630/1250 A type "C" bushings, as specified by EN50180 and EN50181; A wide application range covers cable cross-sections from 25 sq. mm to 500 sq. mm;
- Compatible for use with mechanical or compression type lugs

BENEFITS

- The screened separable connector exceeds CENELEC HD 629.1 S2 requirements, which includes BS, VDE and other international specifications

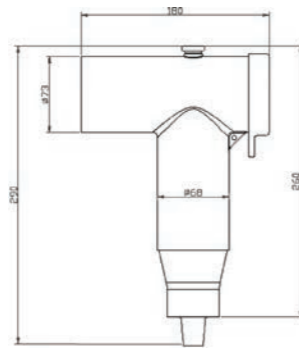

DESIGN & CONSTRUCTION

- Outer conductive layer
- Insulated layer
- Farady cage
- Earthing eye and grounding kit
- Stress cone
- Compression and mechanical lug
- Back plug
- Threaded pin kit
- End cap
- Threaded bolt

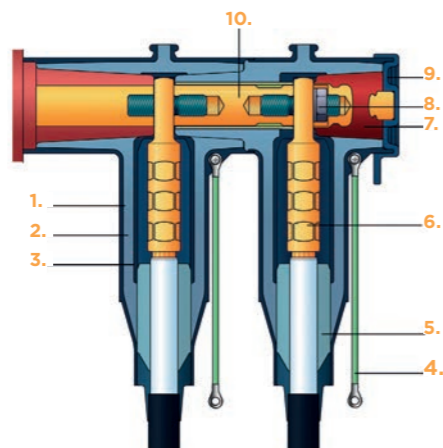

TECHNICAL DATA

Cable insulation range	15.5 - 37 mm
Cable cross-section range	35 - 400 mm ²
Max. Rated voltage	17.5 kV
Rated current	800 A
2Uo PD	< 5 pC
AC withstand, 5 min	54 kV
Thermal short, 1 s	54 kA
Dynamic short, 1 s	85 kA

Meet the international CENELEC HD 629.1 S2 specification and GB 12706.4:2008

SELECTION INFORMATION: DIMENSIONS SHOWN IN MILLIMETERS

6/10 (12) kV single-core, with compression lug

Front Connector	Rear Connector	Insulation Φ (mm)	Cross Section (mm ²)
ELBC-810-50C-SC-12	ELBC-CC-810-50C-SC-12	15.5-19	50
ELBC-810-70C-SC-12	ELBC-CC-810-70C-SC-12	15.5-19	70
ELBC-810-95C-SC-12	ELBC-CC-810-95C-SC-12	18.0-23	95
ELBC-810-120C-SC-12	ELBC-CC-810-120C-SC-12	18.0-23	120
ELBC-810-150C-SC-12	ELBC-CC-810-150C-SC-12	22.0-27	150
ELBC-810-185C-SC-12	ELBC-CC-810-185C-SC-12	22.0-27	185
ELBC-810-240C-SC-12	ELBC-CC-810-240C-SC-12	26.0-32	240
ELBC-810-300C-SC-12	ELBC-CC-810-300C-SC-12	26.0-32	300
ELBC-810-400C-SC-12	ELBC-CC-810-400C-SC-12	31.0-37	400
ELBC-810-500C-SC-12	ELBC-CC-810-500C-SC-12	31.0-37	500

6/10 (12) kV single-core, with mechanical lug

Front Connector	Rear Connector	Insulation Φ (mm)	Cross Section (mm ²)
ELBC-810-5070-SC-12	ELBC-CC-810-5070-SC-12	15.5-19	50-70
ELBC-810-9512-SC-12	ELBC-CC-810-9512-SC-12	18.0-23	95-120
ELBC-810-1518-SC-12	ELBC-CC-810-1518-SC-12	22.0-27	150-185
ELBC-810-2430-SC-12	ELBC-CC-810-2430-SC-12	26.0-32	240-300
ELBC-810-400-SC-12	ELBC-CC-810-400-SC-12	31.0-37	400

ELBC 824

Screened Separable Connector up to 24 kV, 800 A

FEATURES

- ELBC screened separable connectors are made of high modified EPDM rubber which ensures the high dielectric strength and elongation at break;
- A thick conductive EPDM jacket protects the connection system against unintentional contact;
- Unique design makes it fully shielded and submersible when matched with the right bushing or plug;
- Easily accessible back plug with capacitive test point

APPLICATIONS

- ELBC is designed to fit 630/1250 A type "C" bushings, as specified by EN50180 and EN50181; A wide application range covers cable cross-sections from 35 sq. mm to 400 sq. mm;
- Compatible for use with mechanical or compression type lugs

BENEFITS

- The screened separable connector exceeds CENELEC HD 629.1 S2 requirements, which includes BS, VDE and other international specifications



DESIGN & CONSTRUCTION

- Outer conductive layer
- Insulated layer
- Farady cage
- Earthing eye and grounding kit
- Stress cone
- Compression and mechanical lug
- Back plug
- Threaded pin kit
- End cap

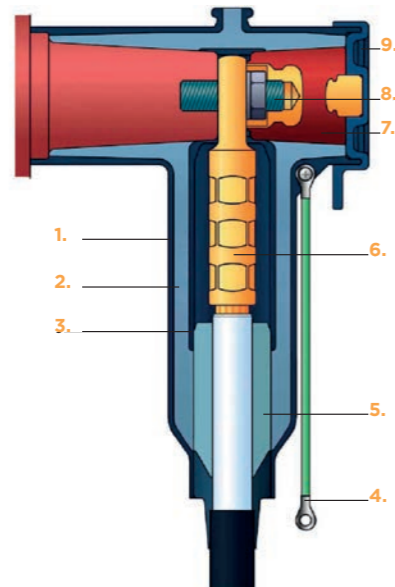

TECHNICAL DATA

Cable insulation range	15.5 - 37 mm
Cable cross-section range	35 - 400 mm ²
Max. Rated voltage	24 kV
Rated current	800 A
Basic impulse level	125 kV
2Uo PD	< 5 pC
AC withstand, 5 min	54 kV
Thermal short, 1 s	54 kA
Dynamic short, 1 s	85 kA

Meet the international CENELEC HD 629.1 S2 specification and GB 12706.4:2008

SELECTION INFORMATION: DIMENSIONS SHOWN IN MILLIMETERS

12/20 (24) kV Single-core, copper conductor with compression copper lug

Front Connector	Rear Connector	Insulation Φ (mm)	Cross Section (mm ²)
ELBC-824-35C-SC	ELBC-CC-824-35C-SC	18-23	35
ELBC-824-50C-SC	ELBC-CC-824-50C-SC	18-23	50
ELBC-824-70C-SC	ELBC-CC-824-70C-SC	18-23	70
ELBC-824-95C-SC	ELBC-CC-824-95C-SC	22-27	95
ELBC-824-120C-SC	ELBC-CC-824-120C-SC	22-27	120
ELBC-824-150C-SC	ELBC-CC-824-150C-SC	26-32	150
ELBC-824-185C-SC	ELBC-CC-824-185C-SC	26-32	185
ELBC-824-240C-SC	ELBC-CC-824-240C-SC	26-32	240
ELBC-824-300C-SC	ELBC-CC-824-300C-SC	31-37	300
ELBC-824-400C-SC	ELBC-CC-824-400C-SC	31-37	400

12/20 (24) kV Single-core with mechanical lug

Front Connector	Rear Connector	Insulation Φ (mm)	Cross Section (mm ²)
ELBC-824-3570-SC	ELBC-CC-824-3570-SC	18-23	35-70
ELBC-824-9512-SC	ELBC-CC-824-9512-SC	22-27	95-120
ELBC-824-1524-SC	ELBC-CC-824-1524-SC	26-32	150-240
ELBC-824-3040-SC	ELBC-CC-824-3040-SC	31-37	300-400

Trifurcation kits for 3-core cables

TRFC-H1	Heat Shrinkable trifurcation kits	3*1 M tubing and 1 pc breakout and 1 m earth braid	95-120
TRFC-C1	Cold Shrinkable trifurcation kits	3*500 mm tube and 1 pc breakout and 1.4 m earth braid	150-240
TRFC-C2	Cold Shrinkable trifurcation kits	6*500 mm tube and 1 pc breakout and 1.4 m earth braid	300-400

Accessories

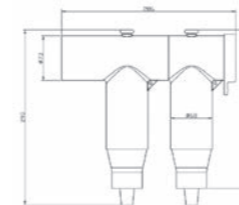
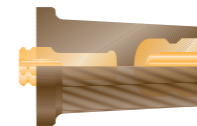
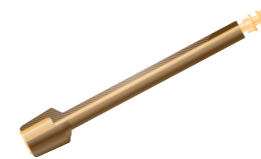

Test Rod	
RSTI-68TR	310 mm
RSTI-68TRL	460 mm
RSTI-68TRA	Kit including 2 short and 1 long rods

Terminal Plug	
RSTI-68TP	

Earthing Adapter	
RSTI-68EA20	Ball Φ 20 mm
RSTI-68EA25	Ball Φ 25 mm

Single Connection	
Material for three phases	1* ELBC-824-xxxx (kit)

Live End Seal	
Material for three phases	1* ELBC-824-xxxx (kit) 1* RSTI 68TP

RSTI

Raychem Switchgear Connection System for CENELEC C1 (630 A) and C2 (1250 A) for 12-36 kV

FEATURES

- Angled prefabricated shielded adapter made of silicone rubber, which does not require heat during installation
- Integrated stress control. Separate termination not required
- 3-core kits include materials for core screening. Up to 2000 mm tail length
- Test point for capacitive voltage measurement
- Mechanical lugs included. Compression lugs on request
- The kits include materials for 3 phases

APPLICATIONS

- For round polymeric insulated single and 3-core cables
- For connection to insulator bushing type C1 (630 A) and C2 (1250A) in accordance with EN 50181
- Disconnection of the body is only permitted when power has been turned off

CONFORMS TO

- Tested in accordance to CENELEC HD 629.1 S2

RSTI Single connection single core

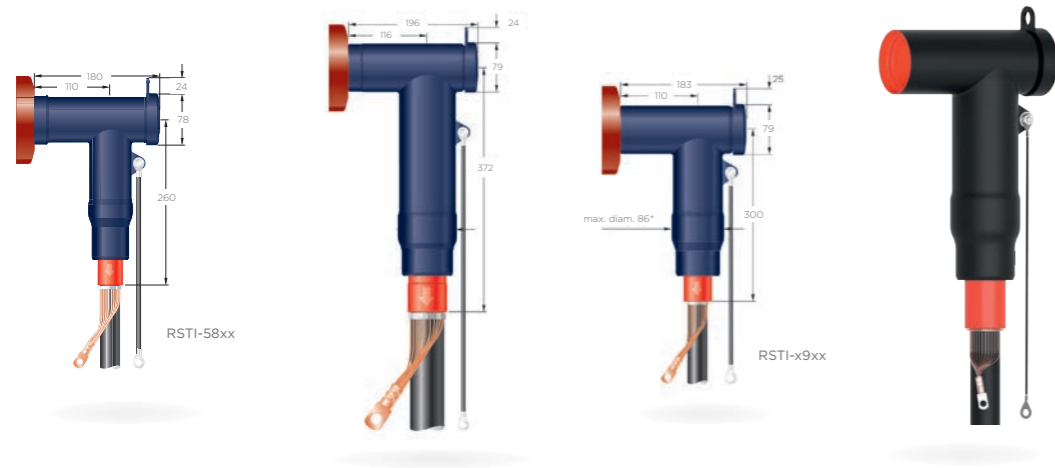

Product name	12 kV (mm)	24 kV (mm)	36 kV (mm)	Insul. diam (mm)	Part number
RSTI-5851	35 – 95	35 – 70	–	12.7 – 23.4	2364400-1
RSTI-5852	95 – 120	–	–	12.7 – 23.4	2364401-1
RSTI-5853	95 – 240	95 – 185	–	17.0 – 30.1	2364402-1
RSTI-5854	150 – 240	95 – 240	–	21.2 – 34.6	2364403-1
RSTI-5855	185 – 300	185 – 300	–	21.2 – 34.6	CM0013-011
RSTI-5856	240 – 400	–	–	21.2 – 34.6	CR5244-011
RSTI-3951	400	–	–	28.9 – 36.4	CR6086-011
RSTI-3952	500	–	–	28.9 – 36.4	CR6085-011
RSTI-3953	630	–	–	34.0 – 45.4	CR6077-011
RSTI-3954	800	–	–	34.0 – 45.4	CR6081-011
RSTI-5951	–	400	–	34.0 – 45.4	CR6082-011
RSTI-5952	–	500	–	34.0 – 45.4	CR6083-011
RSTI-5953	–	630	–	39.1 – 59.0	CR6084-011
RSTI-5954	–	800	–	39.1 – 59.0	CR6080-011
RSTI-6851	–	–	35 – 95	22.4 – 35.5	CR4949-011
RSTI-6852	–	–	95 – 150	22.4 – 35.5	CR4990-011
RSTI-6853	–	–	120 – 240	28.9 – 42.0	CR5011-011
RSTI-6855	–	–	185 – 300	28.9 – 42.0	CR5012-011
RSTI-6951	–	–	400	34.0 – 45.4	CR6079-011
RSTI-6952	–	–	500 – 630	39.1 – 59.0	CR6078-011
RSTI-6953	–	–	800	39.1 – 59.0	CR6087-011

Note: Mechanical lugs included. Compression lugs are available on request. Core screen kits for copper tape screens available on request (add suffix 01 to part number). Pins are required to couple RSTI-CC-58xx and RSTI-CC-68xx to RSTI-x95x, RSTI-SA.

RSTI-CC

Raychem Switchgear Connection System for CENELEC C1 (630 A) and C2 (1250 A) for 12-36 kV

FEATURES

- Angled prefabricated shielded parallel adapter made of silicone rubber, which does not require heat during installation
- Integrated stress control. Separate termination not required
- 3-core kits include materials for core screening. Up to 2000 mm tail length
- Test point for capacitive voltage measurement
- Mechanical lugs included. Compression lugs on request
- The kits include materials for 3 phases

APPLICATIONS

- For parallel connection to adapter type RSTI-58xx
- For round polymeric insulated single and 3-core cables
- Disconnection of the body is only permitted when power has been turned off

CONFORMS TO

- Tested in accordance to CENELEC HD 629.1 S2

RSTI Parallel connection single core

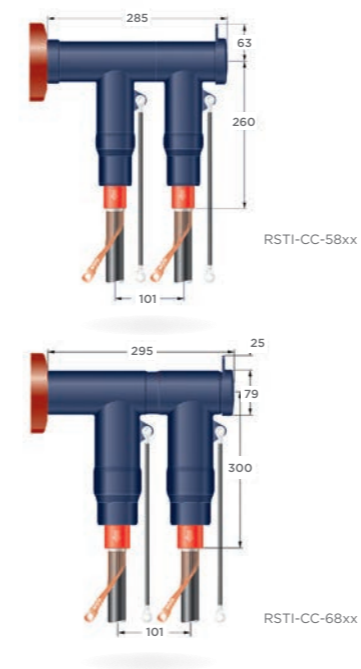

Product name	12 kV (mm)	24 kV (mm)	36 kV (mm)	Insul. diam (mm)	Part number
RSTI-CC-5851	35 – 95	35 – 70	–	12.7 – 23.4	CM0094-011
RSTI-CC-5852	95 – 120	–	–	12.7 – 23.4	CM0095-011
RSTI-CC-5853	95 – 240	95 – 185	–	17.0 – 30.1	2364404-1
RSTI-CC-5854	150 – 240	95 – 240	–	21.2 – 34.6	2364405-1
RSTI-CC-5855	185 – 300	185 – 300	–	21.2 – 34.6	CM0099-011
RSTI-CC-5856	240 – 400	–	–	21.2 – 34.6	CR5240-011
RSTI-CC-3951	400	–	–	28.9 – 36.4	CS8877-011
RSTI-CC-3952	500	–	–	28.9 – 36.4	CS8875-011
RSTI-CC-3953	630	–	–	34.0 – 45.4	CS8874-011
RSTI-CC-3954	800	–	–	34.0 – 45.4	CS8884-000
RSTI-CC-5951	–	400	–	34.0 – 45.4	CS8880-000
RSTI-CC-5952	–	500	–	34.0 – 45.4	CS8879-011
RSTI-CC-5953	–	630	–	39.1 – 59.0	CS8872-000
RSTI-CC-5954	–	800	–	39.1 – 59.0	CS8882-011
RSTI-CC-6851	–	–	35 – 95	22.4 – 35.5	CR7869-011
RSTI-CC-6853	–	–	120 – 240	28.9 – 42.0	CR7866-011
RSTI-CC-6855	–	–	185 – 300	28.9 – 42.0	CR7868-011
RSTI-CC-6951	–	–	400	34.0 – 45.4	CS8881-011
RSTI-CC-6952	–	–	500 – 630	39.1 – 59.0	CS8873-011
RSTI-CC-6953	–	–	800	39.1 – 59.0	CS8876-011

Note: Mechanical lugs included. Compression lugs are available on request. Core screen kits for copper tape screens available on request (add suffix 01 to part number). Pins are required to couple RSTI-CC-58xx and RSTI-CC-68xx to RSTI-x95x, RSTI-SA.

Trifurcation kits for screened 3-core cables

Product name Kit length 600 mm	Part number	Part number Kit length 1200 mm	Part number	"Dimensions over insulation (min. - max. mm)"	Overall diameter (min. - max. mm)
RSTI-TRF-02	CF9506-011	RSTI-TRF-02-1200	CP7143-011	17.6 – 35.6	50.0 – 90.0

RSTI accessories

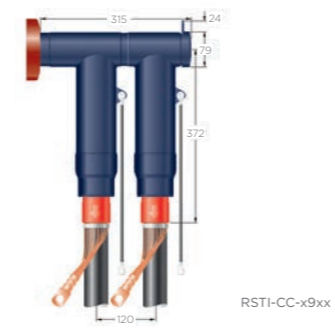

Product name	Accessory type	Part number
RSTI-68TR; Length: 310 mm	Test rod	CN9357-011
RSTI-68TRL; Length: 460 mm	Test rod	CN9356-011
RSTI-68TRA; Kit includes 2 short and 1 long testrod	Test rod	CN9358-011
RSTI-68TP	Terminating plug	CS9958-000
RSTI-68EA20; Ball diameter: 20 mm	Earthing adapter	CS8406-011
RSTI-68EA25; Ball diameter: 25 mm	Earthing adapter	CS8405-011
RSTI-SA-PIN	Coupling Pin	CJ2787-011
RSTI-68RC, one piece per set	Insulating Cap	EP5032-000



Test rod



Terminating plug



Earthing adapter



Insulating cap

RSTI-SA

Raychem Screened Surge Arrester System for 12-36 kV

FEATURES

- Angled screened surge arrester
- The conductive layer on the arrester and the insulating body protect against accidental contact
- Test point for capacitive voltage measurement
- The kits include materials for 3 phases

APPLICATIONS

- The single adapter is used to connect to type C bushings in accordance with EN 50181 in compact switchgear
- The parallel adapter is connected to RSTI-58xx type connectors

CONFORMS TO

- Tested in accordance with IEC 60099-4 (May 2004)

RSTI-SA



Product name	Rated voltage kV	Part number
Single connection		
RSTI-68SA1210	12	CS8930-000
RSTI-68SA2410	24	CS8925-000
RSTI-68SA3610	36	CS8920-000
Parallel connection		
RSTI-CC-68SA1210	12	CS3113-000
RSTI-CC-68SA2410	24	CS3114-069
RSTI-CC-68SA3610	36	CS3036-000

Technical data for single and parallel connection

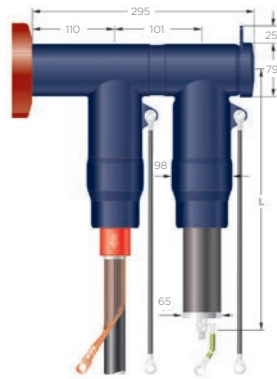

Discharge current I_n	10 kA
Current impulse 4/10 s	100 kA
Short circuit current I_S	20 kA
Long-duration current impulse (1ms)	212 A

Residual voltages (kV)			
Voltage class UC	12	24	36
Rated voltage UR	15	30	45
Current impulse 8/20 s			
5 kA	39.1	78.2	117.3
10 kA	41.5	83.0	124.5
20 kA	45.7	91.4	137.1
Current impulse 1/20 s			
10 kA	43.9	87.8	131.7
Current impulse 1/20 s			
125 kA	31.5	63.1	94.7
500 kA	32.4	64.9	97.4

RSES 64xx

Raychem Screened Adapter System for CENELEC B Bushing 400 A for 24 and 36 kV

FEATURES

- Mechanical lugs suitable for copper and aluminium conductors
- Capacitive test point
- Complete kit including lugs facilitates installation and storage

APPLICATIONS

- Design fits 400 A bushings (interface "B") as specified by EN 50180 and EN 50181
- Cable cross-sections from 50 to 300mm²

CONFORMS TO

- The screened cable connector exceeds CENELEC HD 629.1 S2 requirements, which includes BS, VDE and other international specifications

RSES 6400 for single and three core cables including mechanical lugs

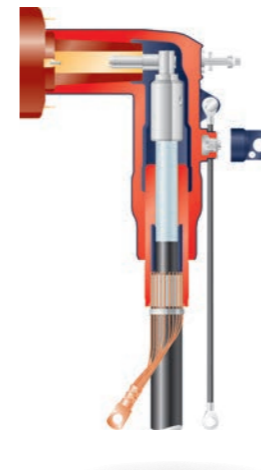

Product name	Rated voltage kV	Cross-section (mm) ²	Insul. diam (mm)	Part number
RSES-6451	24	70 – 95	22.4 – 35.5	CX5399-011
RSES-6452	24	95 – 240	22.4 – 35.5	CX5398-011
RSES-6454	24	185 – 300	22.4 – 35.5	CX5404-011
RSES-6451	36	50 – 95	22.4 – 35.5	CX5399-011
RSES-6452	36	95 – 150	22.4 – 35.5	CX5398-011
RSES-6453	36	120 – 240	28.9 – 42.0	CX5401-011
RSES-6455	36	185 – 300	28.9 – 42.0	CX5402-011

RSES and RSSS-52XX

TE's Raychem Screened Adapter System for CENELEC A Bushing 250 A up to 24 kV

FEATURES

- Range taking mechanical Shear Bolt cable lugs
- Hybrid material design for outstanding mechanical and electrical performance
- Reliable operation even under harsh environmental conditions
- Screened connector body for improved safety
- Molded cable adapter with integrated sealing for easier installation
- Optional Voltage Detection (VD) point
- Optional Metal Housing (MH)

APPLICATIONS

- TE's Raychem Screened Elbow and Straight Separable connectors RSES/ RSSS are designed to connect single-core polymeric cables to medium voltage gas insulated switchgears and other equipments using bushings type "A" (according to EN 50180/EN 50181) specified for 250A continuous current.

CONFORMS TO

- The RSES and RSSS connectors are compliant with CENELEC HD 629.1 S2 02/2006+A1:2008, and tested for a system voltage up to 24 kV

Design & Dimensions

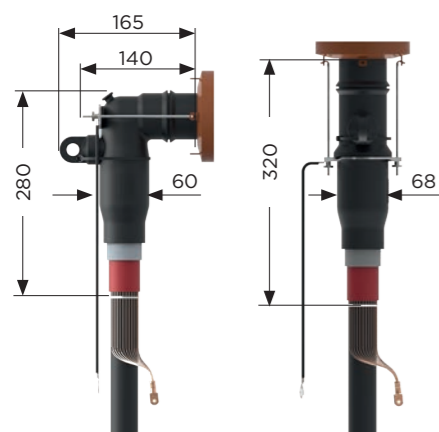

RSES-VD: Elbow connector with voltage detection point
RSSS-VD: Straight connector with voltage detection point

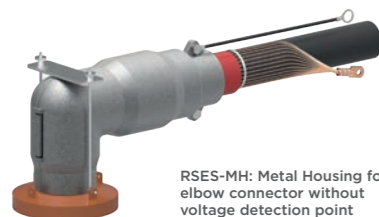

RSES-MH: Metal Housing for elbow connector without voltage detection point

TECHNICAL DATA	
Conductor Cross section Range	16 - 150 mm ²
Diameter over conductor (round, stranded)	4.6 - 15.0 mm
Diameter over conductor (round, solid)	3.5 - 13.8 mm
Cable Insulation Diameter Range	12.7 - 28.5 mm
Maximum System Voltage	24 kV
Continuous Current Rating	250 A
Basic Impulse Level	125 kV
Partial Discharge at 2 U ₀	< 3 pc
AC Voltage Withstand, 5 min	57 kV
DC Voltage Withstand, 15 min	76 kV

TE's RSES and RSSS separable connectors pass a 100% routine test procedure including: AC Voltage Withstand and Partial Discharge Test.

Kit Designation	Connector Type	Conductor cross-section (mm ²) at system voltage level			Diameter over Insulation (mm)
		12 kV	17,5 kV	24 kV	
RSSS-525A	Straight	16 - 70	16 - 50	16	15.3 - 25.0
RSSS-525B	Straight	95	50 - 95	25 - 95	21.9 - 28.5
RSSS-525C	Straight	95 - 150	70 - 120	70 - 95	15.3 - 25.0
RSSS-525D	Straight	-	120 - 150	70 - 150	21.9 - 28.5
RSES-525A	Elbow	16 - 70	16 - 50	16	15.3 - 25.0
RSES-525B	Elbow	95	50 - 95	25 - 95	21.9 - 28.5
RSES-525C	Elbow	95 - 150	70 - 120	70 - 95	15.3 - 25.0
RSES-525D	Elbow	-	120 - 150	70 - 150	21.9 - 28.5

Default kits come without voltage detection point and metal housing, are designed for cables with wire shield and don't include accessories for earthing.

To add accessories to the kit's contents, please use the following kit modification codes:

- Add "-E" to the end of the kit designation for a kit that includes wire shield earthing accessories (e.g. RSES-525A-E)
- Add "-01" to the end of the kit designation for a kit that includes Cu tape shield earthing accessories (e.g. RSES-525A-01)
- Add "-02" to the end of the kit designation for a kit that includes Al foil shield earthing accessories (e.g. RSES-525A-02)
- Add "-VD" to the type designation (RSES/RSSS) for a kit with voltage detection point (e.g. RSES-VD-525A)
- Add "-MH" to the type designation (RSES) for a kit with metal housing (e.g. RSES-MH-525A) [only compatible with elbows without voltage detection point.]

*Application range for conductors acc. to IEC 60228 class 2 Cu compacted. Application range for other combinations of conductor type and material on request.

RSRB

Raychem Heat-shrink Bushing Boots up to 11 kV

Boots



Product name	Application range	Mod code	Part number
Straight boots			
RSRB 4022	10 - 35 mm ²	B05	203793-011
RSRB 4024	50 - 95 mm ²	B06	890945-011
RSRB 4026	120 - 300 mm ²	B07	174821-011
Right angle boots - long			
RSRB 4042	10 - 35 mm ²	B08	363551-011
RSRB 4044	50 - 95 mm ²	B09	257141-011
RSRB 4046	120 - 300 mm ²	B10	718495-011
Right angle boots - short			
RSRB 4062	10 - 35 mm ²	B15	166197-011
RSRB 4064	50 - 95 mm ²	B16	317789-011
RSRB 4066	120 - 300 mm ²	B17	975801-011

RPIT

Raychem Plug In Termination System up to 42 kV for Gas-insulated Switchgear up to 1250 A

FEATURES

- Shielded inline connection for gas insulated switchgears up to 42 kV
- The plug in termination system is metal-enclosed, hermetically insulated and suitable for submersion or outdoor use
- Special designs for wind power stations and offshore applications with bronze protection covers

APPLICATIONS

- Single core cables
- 50 - 630 mm² conductor size
- Inline bushings for connection type size 2 (800 A) and size 3 (1250 A) as per EN 50181

CONFORMS TO

- Tested in accordance with CENELEC HD629.1 S2

RPIT



Type	Size	Nominal current (A)	System voltage (kV)	Cross-section (mm ²)	Diameter over conductor (mm)	"Diameter over insulation (mm)
RPIT-321x	2	800	12	95-300	11.0-21.6	19.3-30.4
RPIT-521x	2	800	24	50-300	7.7-21.6	20.2-34.6
RPIT-621x	2	630	36/42	50-185	7.7-16.8	25.2-35.1
RPIT-331x	3	1250	12	240-630	17.8-32.5	26.4-39.6
RPIT-531x	3	1250	24	150-630	13.9-32.5	36.5-45.6
RPIT-631x	3	1250	36/42	95-630	11.0-32.5	28.5-49.2

RSTF

Screened T-Connectors for Interface F 1250A up to 72.5 kV

FEATURES

- Meet EN 50673 standard
- Tested according to IEC 60840
- 100% routine tested
- End-to-end components traceability
- High performance and longevity in harsh environments
- Compact design for cables with cross sections from 95 mm² to 1200 mm²
- Featuring up to 1800A as combined continuous current rating for T-connector and coupling connector in parallel or inline connection

APPLICATIONS

- Outer cone Screened separable T-connector for 72.5 kV type F bushings
- Suitable for flexible tower cable and subsea array cables

BENEFITS

- Compact design for fast integration into the wind turbine
- Easy to handle in limited space
- Reduced installation time as no special tools are required
- Easy fitting onto the base connector thanks to our patented design and simple installation process
- More flexibility in wind turbine cabling
- State-of-the-art gapless ZnO surge arrester design that eliminates the need for metal enclosure
- Reliable performance in harsh environments as it is corrosion resistant and maintenance-free

RSTF

RSTF Base Connector



RSTF-CC Coupling Connector



RSTF-SA Surge Arrester



TECHNICAL DATA	
Conductor cross-section range	95 mm ² - 1200 mm ²
Maximum system voltage	72.5 kV
Continuous current rating	1250A
Lightning impulse withstand level	325 kV
Partial discharge at 1.5 U ₀	< 5 pc
Heating cycle voltage test (2 U ₀)	72 kV
AC voltage test (2.5 U ₀)	90 kV
Ø over cable insulation	28 mm - 70 mm



Chapter III High Voltage Cable Accessories

IHVT-H/OHVT-H/LHVT-H Heat Shrink Terminations.....	72
OHVT-HS Self Supporting Heat Shrink Terminations.....	73
DC Filter Cables FCEV	74
OHVT-C Outdoor Terminations Composite	75
OHVT-P Outdoor Terminations Porcelain.....	76
OHVT-D Outdoor Terminations Dry Type.....	77
OHVT-G Outdoor Terminations Gel Type	78
OHVT-F Dry Flexible Terminations.....	79
OHVT-FS Self Supporting Dry Flexible Terminations	80
Arcing Horn for Outdoor Terminations (OHVT).....	81
Lifting Device for Outdoor Terminations (OHVT)	81
Grounding Kits	82
Fibre-Optic Add-On Kit.....	82
PHVS & PHVT Dry Plug-In Switchgear and Transformer Terminations.....	83
PHVS & PHVT Add-On Kits for TE's Raychem Dry Plug-In Switchgear and Transformer Terminations	84
EHVS Heat-Shrinkable Joints	86
EHVS-S One Piece Joints.....	87
One Piece Joints up to 145 kV	88
One Piece Joints up to 245 kV	89
EHVS-T Three Piece Joints.....	90
Three Piece Joints up to 145 kV	91
Three Piece Joints up to 170 kV	92
Fibre-Optic Add-On Kit for HV Cable Joints	93
Link Boxes.....	94
Most Popular Cable Sheath Grounding Options.....	95
EPPA-055-Link Boxes.....	99
Selection Tables for TE's Raychem Link Boxes for Single Core Cables.....	100

Learn more at: TE.com/hvca



Heat-Shrinkable Terminations (IHVT-H/ OHVT-H/ LHVT-H)

- APPLICATIONS**
- The TE's Raychem heat-shrinkable terminations are suitable for all climates, areas, and environments, even severely polluted areas, as well as for all installation conditions, including top feed installation
 - Our heat shrink accessories have been used by utilities and industrial companies around the world for more than 50 years
- FEATURES**
- Compact and modular design
 - Heat-shrinkable stress control sleeves
 - Non-tracking, heat-shrinkable outer insulation
 - Water and corrosion-resistant
 - Different creepage distances available
 - Easy to install
 - Suitable for compression and mechanical lugs
 - No special or expensive tools
 - Lightweight components
 - Unlimited shelf life under normal storage conditions
 - No oil or compound filling
 - Reduced waste for disposal
 - Standard storage conditions

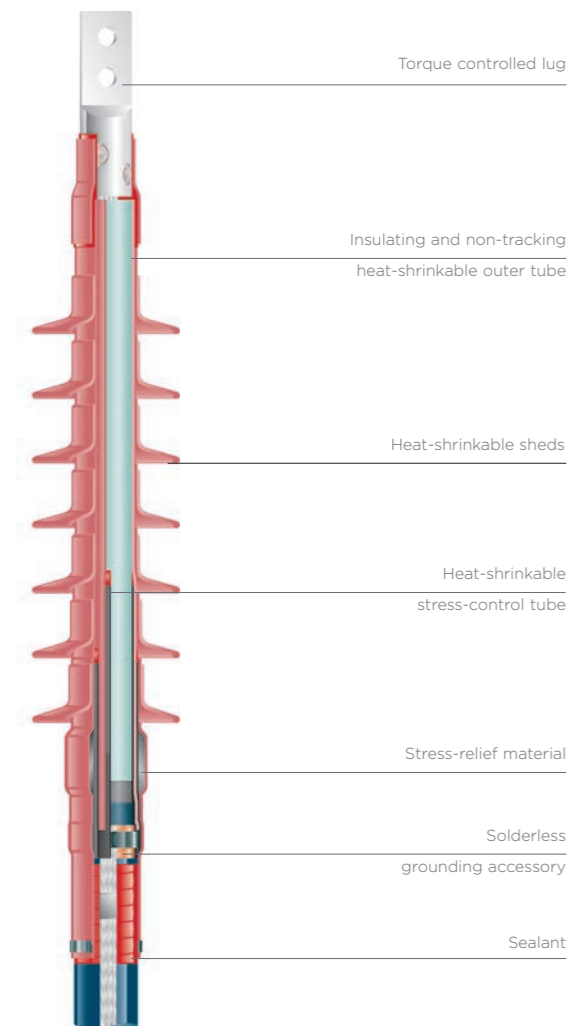

Max. operating voltage U_m (kV)	52	72.5	123
Standards	IEC 60840 IEC 60815	IEC 60840 IEC 60815	IEC 60840 IEC 60815
Rated voltage U (kV)	45 - 47	60 - 69	110 - 115
Rated lightning impulse withstand voltage (BIL) (kV)	250	325	325*

* Reduced level compared to IEC 60840

Self-supporting Heat-Shrinkable Terminations (OHVT-HS)

- APPLICATIONS**
- The TE's Raychem heat-shrinkable terminations are suitable for all climates, areas, and environments, even severely polluted areas, as well as for all installation conditions, including top feed installation
 - Our heat shrink accessories have been used by utilities and industrial companies around the world for more than 50 years
- FEATURES**
- Compact and modular design
 - Heat-shrinkable stress control sleeves
 - Non-tracking, heat-shrinkable outer insulation
 - Water and corrosion-resistant
 - Different creepage distances available
 - Easy to install
 - Suitable for compression and mechanical lugs
 - No special or expensive tools
 - Lightweight components
 - Unlimited shelf life under normal storage conditions
 - No oil or compound filling
 - Reduced waste for disposal
 - Standard storage conditions

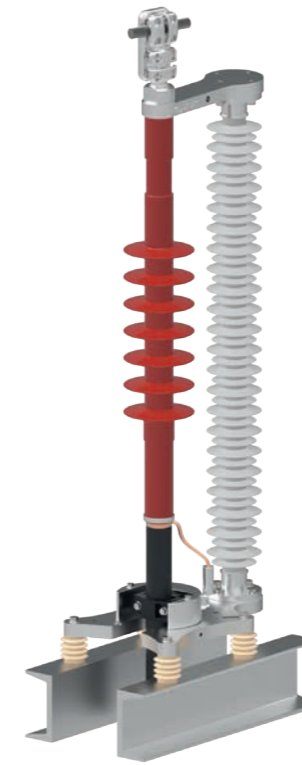

Max. operating voltage U_m (kV)	52	72.5
Standards	IEC 60840 IEC 60815	IEC 60840 IEC 60815
Rated voltage U (kV)	45 - 47	60 - 69
Rated lightning impulse withstand voltage (BIL) (kV)	250	325

Heat-Shrinkable Terminations for DC Filter Cables (FCEV)

APPLICATIONS

- Filter terminations are used in applications where both impedance and non-linear stress control is necessary. The application of the above termination would be in HVDC cables which has an operating voltage up to 200 kV and in the cables used for Very Low Frequency (VLF) testing. The exterior design such as shielding, creepage and protection are developed based on the cable construction and ambient conditions where this termination will be used. The filter cable termination consists of a staggered layer of stress control tubings and patches. A heat-shrinkable non-tracking insulation tubing and shed are shrunk over the stress control system and ensure a reliable seal to the lug and the oversheath.

FEATURES

- Compact and modular design
- Heat-shrinkable stress control sleeves
- Non-tracking, heat-shrinkable outer insulation
- Easy to install
- No special or expensive tools
- Lightweight components
- Unlimited shelf life under normal storage conditions
- No oil or compound filling
- Reduced waste for disposal

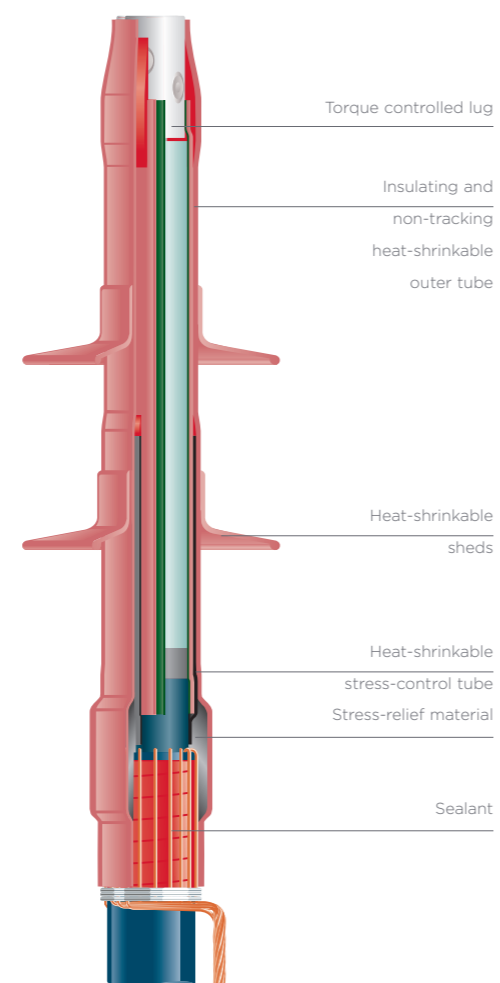

Max. operating voltage U_m (kV)	111	150	200
DC withstand test (kV)	200	300	365 kV
Rated lightning impulse withstand voltage (BIL) (kV)	240	325	425 kV

Outdoor Terminations Composite (OHVT-C)



APPLICATIONS

- The termination is designed for voltage classes up to 245 kV and to operate under severe environmental conditions. Polymeric insulated cables of various designs can be adopted with respect to shielding and metal sheath. Composite housings with different creepage lengths up to 50 mm/kV are available for the most common and also extreme pollution levels according to IEC 60071-1 and IEC 60071-2

FEATURES

- Pressure-tight and light weight composite housing
- Pre-fabricated and factory-tested Silicone-rubber stress cone
- Torque-controlled conductor bolt
- No special tools required to install the termination
- Silicone-oil filling without preheating
- Insulated base plate for sectionalization
- Fittings made of corrosion-resistant alloy
- Type tested according to IEC 60840 and IEC 62067 standards

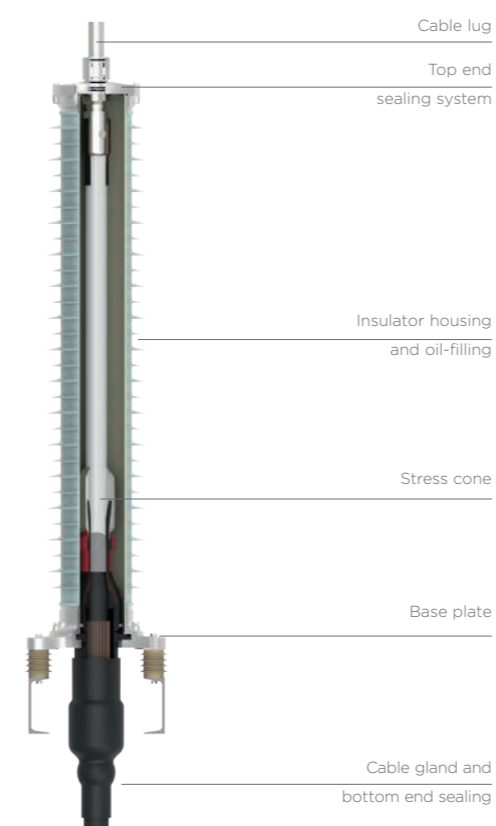

Max. operating voltage U_m (kV)	72.5	123	145	170	245
Standards	IEC 60840 IEC 60815	IEC 60840 IEC 60815	IEC 60840 IEC 60815	IEC 60840 IEC 60815	IEC 62067 IEC 60815
Rated voltage U (kV)	60 - 69	110 - 115	132 - 138	150 - 161	220 - 230
Rated lightning impulse withstand voltage (BIL) (kV)	325	550	650	750	1050

Outdoor Terminations Porcelain (OHVT-P)

APPLICATIONS

- The termination is designed for voltage classes up to 245 kV and to operate under severe environmental conditions. Polymeric insulated cables of various designs can be adopted with respect to shielding and metal sheath

FEATURES

- Well-proven porcelain housing
- Pre-fabricated and factory-tested Silicone-rubber stress cone
- Torque-controlled conductor bolt
- H/S components used for sealing
- No special tools required to install the termination
- Silicone-oil filling without preheating
- Insulated base plate for sectionalization
- Fittings made of corrosion resistant alloy
- Type tested according to IEC 60840 and IEC 62067 standards

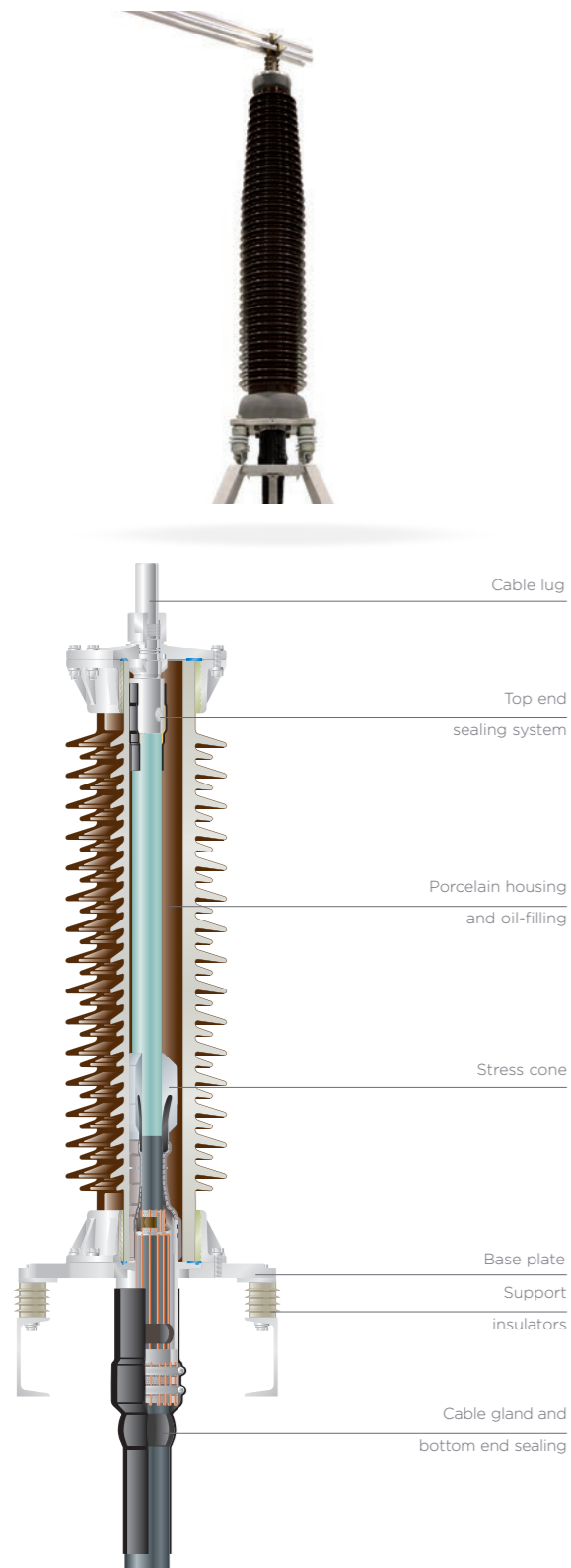

Max. operating voltage U_m (kV)	72.5	123	145	245
Standards	IEC 60840 IEC 60815	IEC 60840 IEC 60815	IEC 60840 IEC 60815	IEC 62067 IEC 60815
Rated voltage U (kV)	60 - 69	110 - 115	132 - 138	220 - 230
Rated lightning impulse withstand voltage (BIL) (kV)	325	550	650	1050

Outdoor Terminations Dry-type (OHVT-D)

APPLICATIONS

- The dry self-supporting termination is designed for voltage class 145 kV and operation under severe environmental conditions. It is free from any insulating liquid or gel. Polymeric insulated cables of various designs can be adopted with respect to shielding and metal sheath. The termination is easily separable and consists of a plug-in part and an epoxy resin insulator protected with a directly moulded silicone shed housing. Due to the short cable cut-back dimensions of the plug-in, the time required to install the termination is very short and can be further reduced by pre-installing the plug-in on the shop floor. The plug-in is similar to the plug-in used with our dry switchgear/transformer termination

FEATURES

- Dry interface, no oil-filling
- Self-supporting
- Pre-fabricated and factory tested silicone-rubber stress cone
- Torque-controlled multi-contact conductor bolt
- Fast and simple installation combining GIS plug-in technology with polymeric insulators
- No special tools required to install the termination
- Insulated cable gland for sectionalization
- Type tested according to IEC 60840

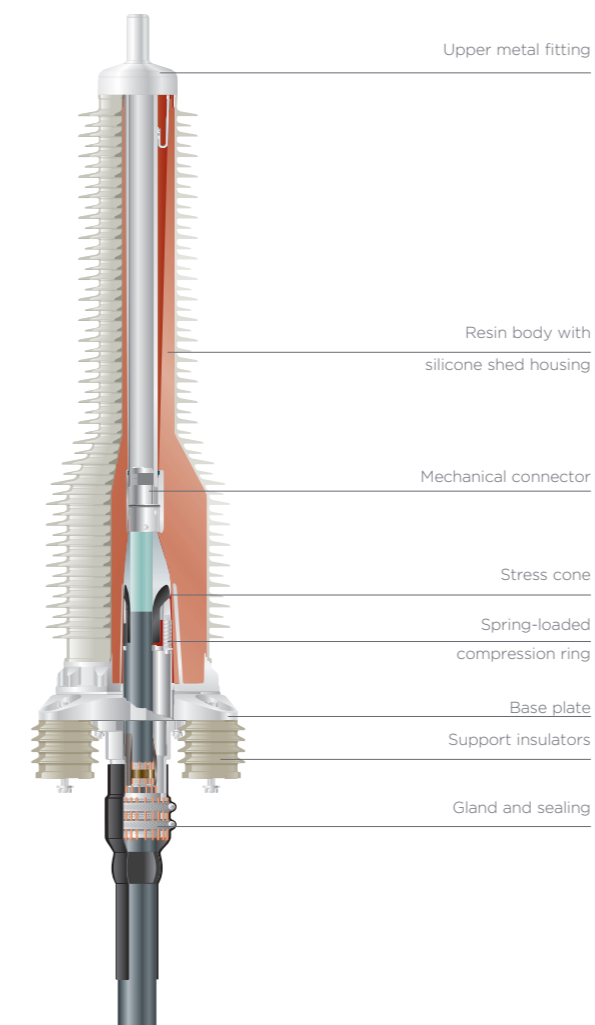
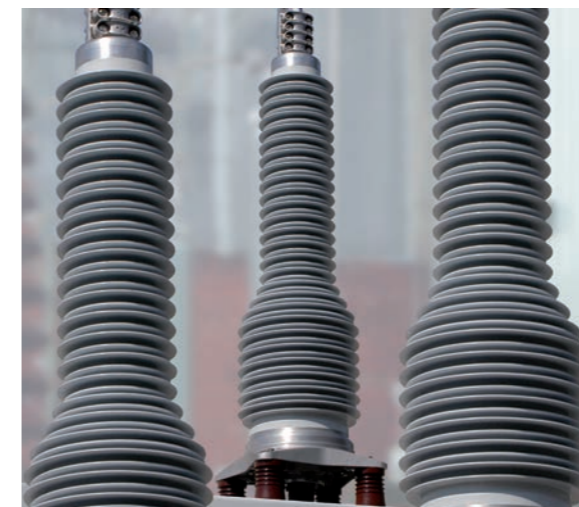

Max. operating voltage U_m (kV)	123	145
Standards	IEC 60840 IEC 60815	IEC 60840 IEC 60815
Rated voltage U (kV)	110 - 115	132 - 138
Rated lightning impulse withstand voltage (BIL) (kV)	550	650



Outdoor Terminations Gel Type (OHVT-G)

APPLICATIONS

- The termination is designed for voltage classes up to 145 kV and to operate under severe environmental conditions. Polymeric insulated cables of various designs can be adopted with respect to shielding and metal sheath. Composite housings with different creepage lengths up to 50 mm/kV are available for the most common and also extreme pollution levels according to IEC 60071-1 and IEC 60071-2

FEATURES

- The insulators are filled with a 2 part gel
- Pressure-tight and light weight composite housing
- Pre-fabricated and factory-tested Silicone-rubber stress cone
- Torque-controlled conductor bolt
- No special tools required to install the termination
- Insulating medium Rayfil is a Gel which is ensuring no leakages
- Insulated base plate for sectionalization
- Fittings made of corrosion-resistant alloy
- Type tested according to IEC 60840

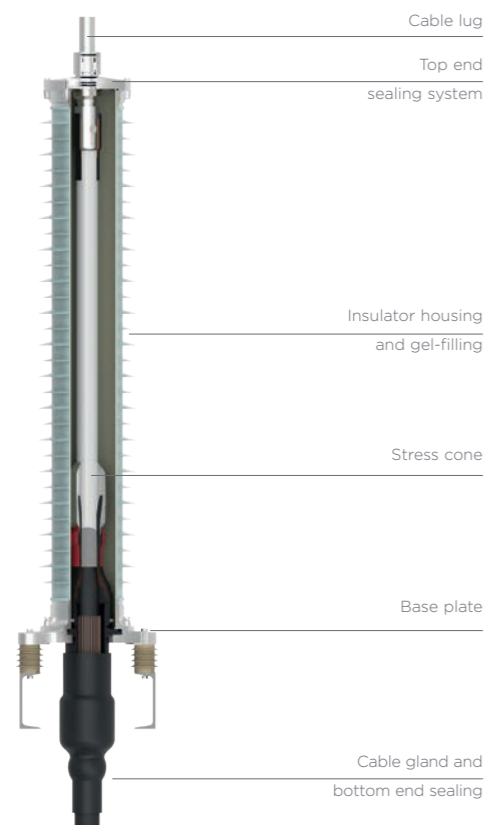

Max. operating voltage U_m (kV)	72.5	123	145	170	245
Standards	IEC 60840 IEC 60815	IEC 60840 IEC 60815	IEC 60840 IEC 60815	IEC 60840 IEC 60815	IEC 62067 IEC 60815
Rated voltage U (kV)	60 - 69	110 - 115	132 - 138	150 - 161	220 - 230
Rated lightning impulse withstand voltage (BIL) (kV)	325	550	650	750	1050

Dry Flexible Terminations (OHVT-F)

APPLICATIONS

- The self supporting dry flexible termination is designed for voltage glass up to 145 kV and operating under severe environmental condition, it is free from any insulating liquid or gel so it is no risk of leakage. Various polymeric cable with different shielding and metal sheath can be adapted based on customized design.

FEATURES

- Dry interface, no leakage risk
- Pre-fabricated and 100% factory tested
- Light weight
- Solderless grounding system, eliminate the risk of overheated cable
- Flexible on the installation angle

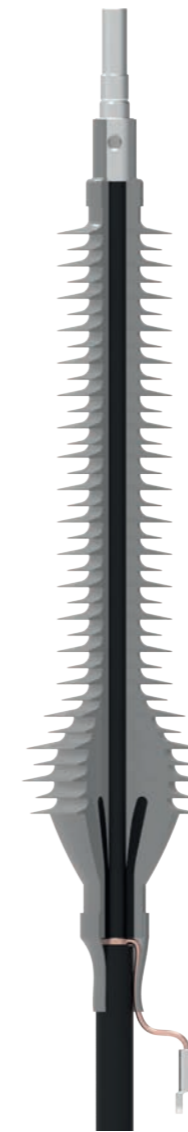

Max. operating voltage U_m (kV)	123	145
Standards	IEC 60840 IEC 60815	IEC 60840 IEC 60815
Rated voltage U (kV)	110 - 115	132 - 138
Rated lightning impulse withstand voltage (BIL) (kV)	550	650

Self-Supporting Dry Flexible Terminations (OHVT-FS)

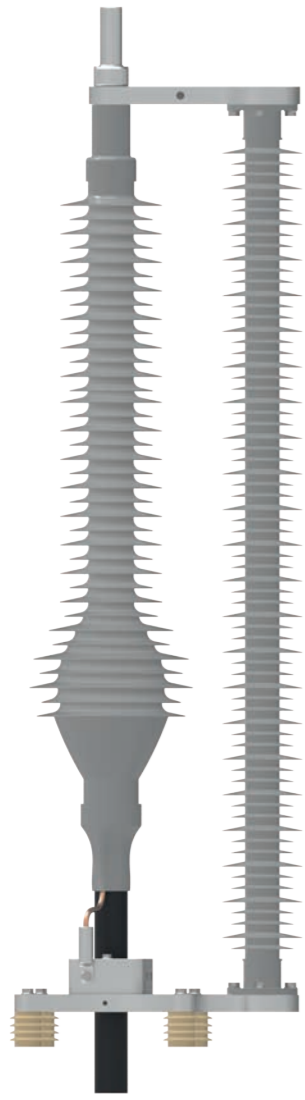

APPLICATIONS

- The self supporting dry flexible termination is designed for voltage class up to 145 kV and operating under severe environmental condition, it is free from any insulating liquid or gel so it is no risk of leakage. Various polymeric cable with different shielding and metal sheath can be adapted based on customized design.

FEATURES

- Dry interface, no leakage risk
- Pre-fabricated and 100% factory tested
- Light weight
- Solderless grounding system, eliminate the risk of overheated cable
- Self-support to enhance mechanical performance

Max. operating voltage U_m (kV)	123	145
Standards	IEC 60840 IEC 60815	IEC 60840 IEC 60815
Rated voltage U (kV)	110 - 115	132 - 138
Rated lightning impulse withstand voltage (BIL) (kV)	550	650

Arcing Horn for Outdoor Terminations (OHVT)



APPLICATIONS

- The arcing horns are made to protect the insulators from damage during a flashover. In case of overvoltages, the horns provide a separate breakdown path through the air and keep the flash over away from the insulator surface. As a result of this, the probability of insulator damage by overvoltage is reduced dramatically. The gap length can be adjusted so that the overvoltage withstand-level is variable

FEATURES

- Easy installation
- Various flashover lengths available
- No contact to the grounding system of the termination and power cable for isolated operation
- May be used for porcelain and composite insulators
- Special designs on request

Lifting Device for Outdoor Terminations (OHVT)



APPLICATIONS

- This lifting device is designed for lifting the installed termination, including the cable, to high positioned installation sites

FEATURES

- Comfortable and safe installation of the termination on the ground
- Designed to lift the complete installed and oil filled termination with cable
- Easy placement and mounting onto the rack on the pylon
- Applicable for all TE Connectivity terminations up to 170 kV
- Adjustable to all common cable sizes up to a diameter over cable sheath of 110 mm
- Easy assembling and handling
- Entire pulling force is applied to the cable only; no mechanical stress is applied to the termination
- Lifting slings and shackles are not included in the kit, because of their yearly safety check regulations
- Maximum lifting weight 500 kg



Grounding kits for Outdoor terminations for Dry Plug-in Switchgear and Transformer Terminations

- APPLICATIONS**
- Suitable for the proper connection of the ground to the high voltage cable accessories
- FEATURES**
- Either for direct grounding or via sheath voltage limiter (SVL)
 - Usable for outdoor terminations
 - Usable for Plug for Dry Plug-in Switchgear and Transformer Terminations,
 - Different SVL levels available
 - Different cross-sections available

Technical Data

SVL (Ur)	Cable Cross Section (mm ²)	Indoor/Outdoor Application	
		Part Number	Description
Without SVL	95	EN8080-000	HVCA-GND-LEAD-95
	240	EN8081-000	HVCA-GND-LEAD-240

SVL (Ur)	Cable Cross Section (mm ²)	Indoor Application		Outdoor Application	
		Part Number	Description	Part Number	Description
1 kV	95	EN8082-000	HVCA-GND-LEAD-I-1-95	EN8088-000	HVCA-GND-LEAD-O-1-95
	240	EN8083-000	HVCA-GND-LEAD-I-1-240	EN8089-000	HVCA-GND-LEAD-O-1-240
3 kV	95	EN8084-000	HVCA-GND-LEAD-I-3-95	EN8090-000	HVCA-GND-LEAD-O-3-95
	240	EN8085-000	HVCA-GND-LEAD-I-3-240	EN8091-000	HVCA-GND-LEAD-O-3-240
6 kV	95	EN8086-000	HVCA-GND-LEAD-I-6-95	EN8092-000	HVCA-GND-LEAD-O-6-95
	240	EN8087-000	HVCA-GND-LEAD-I-6-240	EN8079-000	HVCA-GND-LEAD-O-6-240



Fibre-Optic Add-On Kit for Outdoor Terminations

- APPLICATIONS**
- The TE's Raychem fibre-optic add-on kit is designed to connect the glass fibres integrated in HV cables. The kit includes all components required to seal the cable jacket and the fibre-optic outlet securely and to protect the sensitive optical fibres that are housed inside the steel pipes
 - The standard add-on kit is suitable for connecting two individual steel pipes each with a maximum of 24 optical fibres
- FEATURES**
- Gel-sealing technology ensures reliable outdoor operation
 - Enhanced fibre management
 - The splice box is easy to open and close without the use of special tools
 - The kits are available for TE's Raychem outdoor terminations

Dry Plug-In Switchgear and Transformer Terminations (PHVS & PHVT)

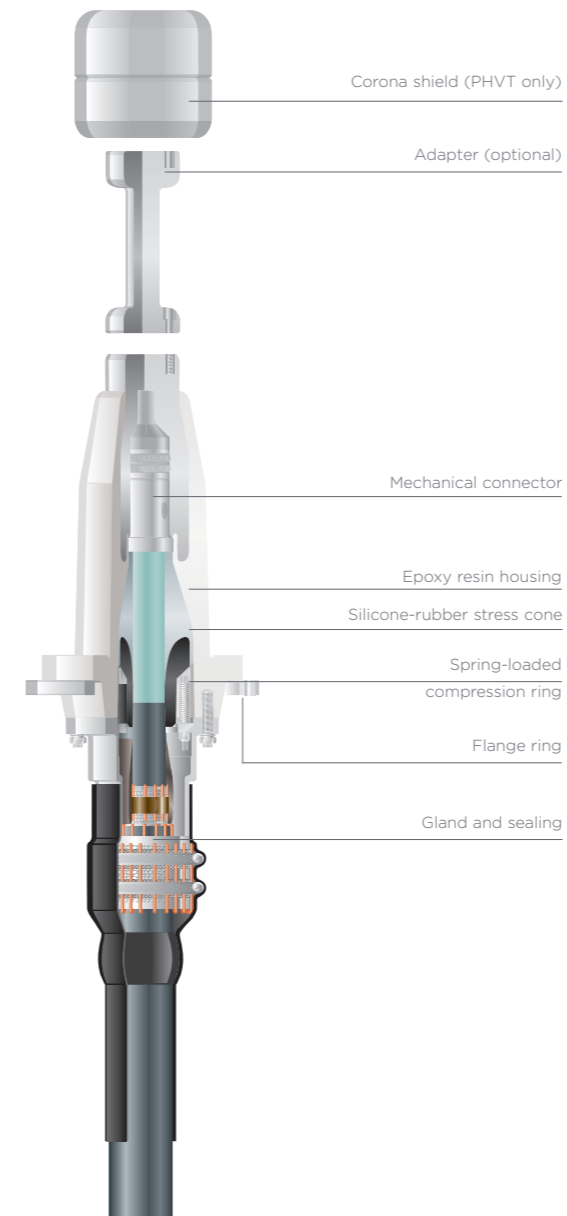

APPLICATIONS

- The dry compact switchgear termination for voltage classes up to 245 kV is designed to be installed in cable entry housings of gas-insulated switchgear (GIS). It complies with IEC 62271-209 standard, which essentially specifies the interfaces between the termination and the switchgear. Therefore, the termination will fit into all GIS that comply with IEC 62271-209. Adapters are available to match the dimensions of wet (oil-filled) type terminations, and older designs specified in IEC 60859. The termination operates in SF6 but also in insulating liquids like transformer oil. A corona shield at the top of the termination then provides the necessary shielding for the terminal. The termination is easily separable and consists of a plug-in part and an epoxy resin insulator. The insulator can be installed by the GIS or transformer manufacturer directly at the factory, saving installation time on-site and reducing the risk of contamination of the cable entry housing

FEATURES

- Dry interfaces, no oil-filling
- Dimensions comply with IEC 62271-209
- Pressure-tight resin housing
- Operates in SF6 and insulating liquids
- Pre-fabricated and factory-tested silicone-rubber stress cone
- Torque-controlled or wedge-type multi-contact conductor bolt
- No special tools required to install the termination
- Insulated cable gland for sectionalization
- Type tested according to IEC 60840, IEC 62067 and IEC 62271-209 standards

Max. operating voltage U _m (kV)	72.5	123	145	170	245
Standards	IEC 60840 IEC 62271-209	IEC 60840 IEC 62271-209	IEC 60840 IEC 62271-209	IEC 60840 IEC 62271-209	IEC 62067 IEC 62271-209
Rated voltage U (kV)	60 - 69	110 - 115	132 - 138	150 - 161	220 - 230
Rated lightning impulse withstand voltage (BIL) (kV)	325	550	650	750	1050

Blind Plug for Dry Plug-In Switchgear and Transformer Terminations



- APPLICATIONS**
- Suitable for use when the switchgear is under operation without a cable connection. The blind plug (also known as dead end plug or dummy plug) is used to close the socket of the cable entry housing
- FEATURES**
- Voltage proof and can be used for continuous operation at nominal voltage
 - Easy installation - similar to standard plug in
 - Blind plug is removable and can be used as a temporary solution until the cable is connected
 - Blind plug is re-usable
 - Type tested according to the IEC 60840 standard

Part Number	Product Description	Comments
CV2954-000	PHVX-72-BLIND-PLUG	Blind plug for PHVX-72 series
CV7128-000	PHVX-145-BLIND-PLUG	Blind plug for PHVX-145 (size 1) and PHVX-170 (size 1)
BM7977-000	PHVX-170-BLIND-PLUG	Blind plug for PHVX-145 (size 2) and PHVX-170 (size 2)



Test Plate for Dry Plug-In Switchgear and Transformer Terminations

- APPLICATIONS**
- Suitable for use where the switchgear needs to be tested. The plate is an adapter to pressurize the inner part of the insulator with SF6.
- FEATURES**
- Pressure tested
 - Suitable manometer available
 - Reuseable

Part Number	Part Description	Comments
CN0832-000	PHVX-193-TEST-CLOSURE	Test plate for PHVX-72, PHVX-145 (size 1) and PHVX-170 (size 1)
BM5750-000	PHVX-223-TEST-CLOSURE	Test plate for PHVX-145 (size 2) and PHVX-170 (size 2)
BM7070-000	PHVX-330-TEST-CLOSURE	Test plate for PHVX-245

Current Test Plug for Dry Plug-in Switchgear and Transformer Terminations



- APPLICATIONS**
- Suitable for carrying out current tests on equipment fitted with bushings PHVS/PHVT
- FEATURES**
- Re-usable
 - Usable for transformer current tests
 - Usable for GIS current tests

Part Number	Part Description	Comments
EN5949-000	PHVX-72-CURRENT-TEST-PLUG	Current test plug for PHVX-72 series
EN5950-000	PHVX-145-CURRENT-TEST-PLUG	Current test plug for PHVX-145 (size 1) and PHVX-170 (size 1)
EN5951-000	PHVX-170-CURRENT-TEST-PLUG	Current test plug for PHVX-145 (size 2) and PHVX-170 (size 2)
EN5952-000	PHVX-245-CURRENT-TEST-PLUG	Current test plug for PHVX-245 series

Cable fixing device for Dry Plug-in Switchgear and Transformer Terminations



- APPLICATIONS**
- Suitable for fixing power cables with bushings PHVS/PHVT
- FEATURES**
- Re-usable
 - Fits on supplied standard flanges
 - Avoids cable bending
 - Non magnetic

Part Number	Part Description	Flange Diameter (mm)	Diameter Over Cable Sheath (mm)	Comments
EN8059-000	PHVX-CABLE-FIX-270-26/38	270	26...38	Fits on PHVX-72 series
EN8060-000	PHVX-CABLE-FIX-270-36/52	270	36...52	Fits on PHVX-72 series
EN8061-000	PHVX-CABLE-FIX-270-46/75	270	46...75	Fits on PHVX-72 series
EN8062-000	PHVX-CABLE-FIX-270-72/100	270	72...100	Fits on PHVX-72 series
EN8063-000	PHVX-CABLE-FIX-320-26/38	320	26...38	Fits on PHVX-145 series and PHVX-170 series
EN8064-000	PHVX-CABLE-FIX-320-36/52	320	36...52	Fits on PHVX-145 series and PHVX-170 series
EN8065-000	PHVX-CABLE-FIX-320-46/75	320	46...75	Fits on PHVX-145 series and PHVX-170 series
EN8066-000	PHVX-CABLE-FIX-320-72/100	320	72...100	Fits on PHVX-145 series and PHVX-170 series
EN8067-000	PHVX-CABLE-FIX-320-100/130	320	100...130	Fits on PHVX-145 series and PHVX-170 series

Heat-Shrinkable Joints (EHVS-H)

APPLICATIONS

- Polymeric insulated cables of various designs can be adapted with respect to shielding and metal sheath. Our heat shrink accessories have been used by utilities and industrial companies around the world for more than 50 years. This ongoing field experience has us a leader in materials science and technology for high voltage applications. Our materials technology is at the core of the development of our heat-shrinkable joints. The materials, used in TE Connectivity TE's Raychem cable accessories, have been extensively optimized with respect to product design and function, manufacturing, and expected service environments

FEATURES

- Compact and modular design
- Heat-shrinkable stress control sleeves
- Torque-controlled connector
- Joint fits on all polymeric cable constructions
- Proven shield continuity concept
- Short cut-back dimension
- Cable size transition possible
- Water and corrosion-resistant
- Easy and fast to install
- No special or expensive tools required
- Lightweight components
- Unlimited storage life-time under normal conditions
- Reduced waste for disposal
- Wide installed base at international customers

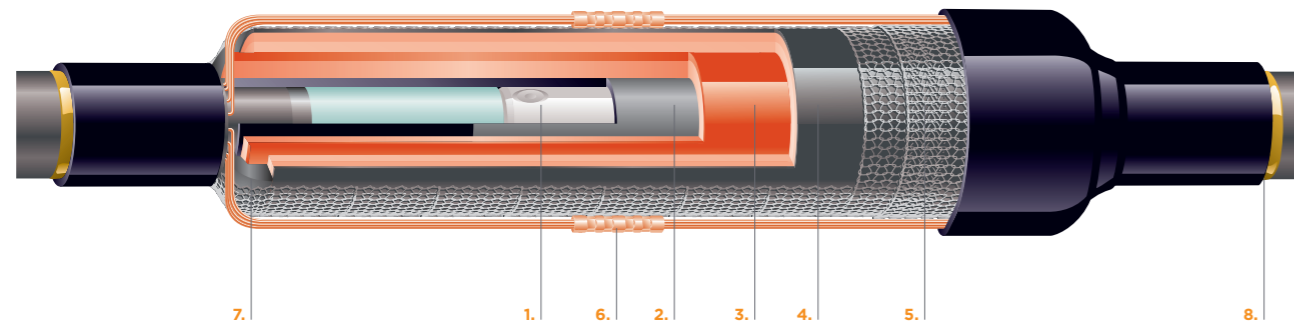

1. Mechanical connector
2. Electrical stress control tube
3. Insulating tubing
4. Screened insulating tubing
5. Copper mesh
6. Solderless shield connection
7. Sealant/mastic
8. Outer protection with integrated moisture barrier

Max. operating voltage U_m (kV)	52	72.5
Standards	IEC 60840	IEC 60840
Rated voltage U (kV)	45 - 47	60 - 69
Rated lightning impulse withstand voltage (BIL) (kV)	250	325

One Piece Joints (EHVS-S)

APPLICATIONS

- The joint is a pre-fabricated one-piece design for voltage classes up to 245 kV. Polymeric insulated cables of various designs can be adapted with respect to shielding and metal sheath. The silicone rubber joint body with integrated geometrical stress control, provides proven electrical function. The joint components combine electrical performance, stress control and moisture sealing to provide the important functions required for all high voltage products

FEATURES

- Premoulded one-piece joint body
- Torque-controlled connector
- Choice of outer sealing and protection systems
- Joint fits on all polymeric cable constructions
- Proven shield continuity concept
- Factory-tested silicone-rubber body
- Special silicone rubber provides perfect compression force for optimised electrical performance
- Simple assembly
- No tension set of joint body
- Moulded thick outer conductive screen
- Geometrical electrical stress control by moulded conductive deflectors
- Type tested according to IEC 60840, IEC 62067 standards

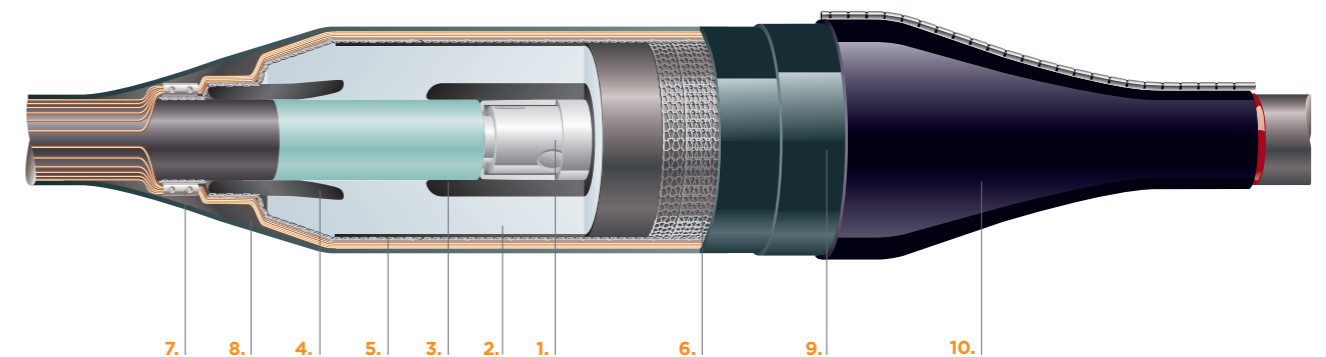

1. Mechanical connector
2. Silicone rubber body
3. Inner electrode/Faraday cage
4. Deflector
5. Outer screen
6. Copper mesh
7. Solderless shield connection
8. Sealant/mastic
9. Insulating tubes
10. Outer protection with integrated moisture barrier

Max. operating voltage U_m (kV)	145	245
Standards	IEC 60840	IEC 62067
Rated voltage U (kV)	132 - 138	220 - 230
Rated lightning impulse withstand voltage (BIL) (kV)	650	1050

One Piece Joints 145 kV

Heat-shrink Rejacketing



Product description	Conductor cross section (mm ²)	Diameter over cable insulation (prepared) (mm)	Max. diameter over outer cable sheath (mm)	Length (mm)	Diameter (mm)	Screen treatment
EHVS-145SW	500 - 2500	60 - 112	130	2400	220	Inline / shield break / grounded

Copper Casing



Product description	Conductor cross section (mm ²)	Diameter over cable insulation (prepared) (mm)	Max. diameter over outer cable sheath (mm)	Length (mm)	Diameter (mm)	Screen treatment
EHVS-145SC	500 - 2500	60 - 112	130	2400	280	Inline / shield break / grounded

Coffin Box



Product description	Conductor cross section (mm ²)	Diameter over cable insulation (prepared) (mm)	Max. diameter over outer cable sheath (mm)	Length (mm)	Diameter (mm)	Screen treatment
EHVS-145SB	500 - 2500	60 - 112	130	3000	350	Inline / shield break / grounded

Heavy Duty (Copper Casing and Coffin Box)



Product description	Conductor cross section (mm ²)	Diameter over cable insulation (prepared) (mm)	Max. diameter over outer cable sheath (mm)	Length (mm)	Diameter (mm)	Screen treatment
EHVS-145SH	500 - 2500	60 - 112	130	3000	350	Inline / shield break / grounded

One Piece Joints 245 kV

Heat-shrink Rejacketing



Product description	Conductor cross section (mm ²)	Diameter over cable insulation (prepared) (mm)	Max. diameter over outer cable sheath (mm)	Length (mm)	Diameter (mm)	Screen treatment
EHVS-245SW	300 - 2500	71 - 119	150	2500	310	Inline / shield break / grounded

Copper Casing



Product description	Conductor cross section (mm ²)	Diameter over cable insulation (prepared) (mm)	Max. diameter over outer cable sheath (mm)	Length (mm)	Diameter (mm)	Screen treatment
EHVS-245SC	300 - 2500	71 - 119	150	2500	350	Inline / shield break / grounded

Coffin Box

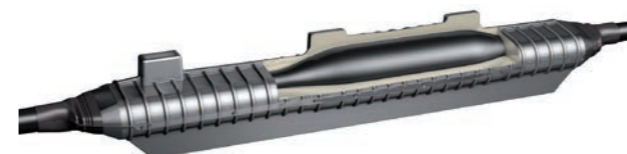

Product description	Conductor cross section (mm ²)	Diameter over cable insulation (prepared) (mm)	Max. diameter over outer cable sheath (mm)	Length (mm)	Diameter (mm)	Screen treatment
EHVS-245SB	300 - 2500	71 - 119	150	3500	550	Inline / shield break / grounded

Heavy Duty (Copper Casing and Coffin Box)



Product description	Conductor cross section (mm ²)	Diameter over cable insulation (prepared) (mm)	Max. diameter over outer cable sheath (mm)	Length (mm)	Diameter (mm)	Screen treatment
EHVS-245SH	300 - 2500	71 - 119	150	3500	550	Inline / shield break / grounded

Three Piece Joints (EHVS-T)

APPLICATIONS

- The joint is a pre-fabricated three piece design for voltage classes up to 170 kV. Polymeric insulated cables of various designs can be adapted with respect to shielding and metal sheath. The silicone rubber joint parts with integrated geometrical stress control provides proven electrical function. The joint components combine electrical performance, stress control, and moisture sealing to provide the important functions required for all high voltage products

FEATURES

- Premoulded three piece joint design
- Torque-controlled connector
- Joint fits on all polymeric cable constructions
- Proven shield continuity concept
- Factory-tested silicone rubber bodies
- Special silicone rubber provides perfect compression force for optimized electrical performance
- Short cut-back dimensions
- No special tools required to install the joint
- Cable size transition possible
- No tension set of joint body
- Moulded outer conductive screen
- Geometrical electrical stress control by moulded conductive deflectors
- Type tested according to IEC 60840 standards

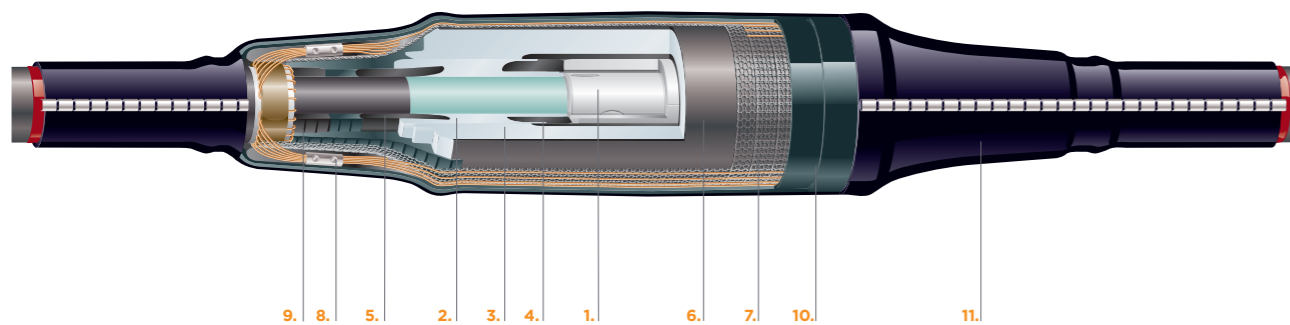

- Mechanical connector
- Silicone rubber adapter body
- Silicone rubber main body
- Inner electrode/Faraday cage
- Deflector
- Outer screen (moulded)
- Copper mesh
- Solderless shield continuity
- Sealant/mastic
- Insulating tubes
- Outer protection with integrated moisture barrier

Max. operating voltage U_m (kV)	145	170
Standards	IEC 60840	IEC 60840
Rated voltage U (kV)	132 - 138	150 - 161
Rated lightning impulse withstand voltage (BIL) (kV)	650	750

Three Piece Joints 145 kV

Heat-shrink Rejacketing



Product description	Conductor cross section (mm ²)	Diameter over cable insulation (prepared) (mm)	Max. diameter over outer cable sheath (mm)	Length (mm)	Diameter (mm)	Screen treatment
EHVS-145TW	185 - 1600	43 - 83	105	2000	200	Inline / shield break / grounded
EHVS-145TW	1600 - 2500	60 - 112	130	2000	250	Inline / shield break / grounded

Copper Casing



Product description	Conductor cross section (mm ²)	Diameter over cable insulation (prepared) (mm)	Max. diameter over outer cable sheath (mm)	Length (mm)	Diameter (mm)	Screen treatment
EHVS-145TC	185 - 1600	43 - 83	105	2500	250	Inline / shield break / grounded
EHVS-145TC	1600 - 2500	60 - 112	130	2500	250	Inline / shield break / grounded

Coffin Box



Product description	Conductor cross section (mm ²)	Diameter over cable insulation (prepared) (mm)	Max. diameter over outer cable sheath (mm)	Length (mm)	Diameter (mm)	Screen treatment
EHVS-145TB	185 - 1600	43 - 83	105	3000	350	Inline / shield break / grounded
EHVS-145TB	1600 - 2500	60 - 112	130	3000	450	Inline / shield break / grounded

Heavy Duty (Copper Casing and Coffin Box)

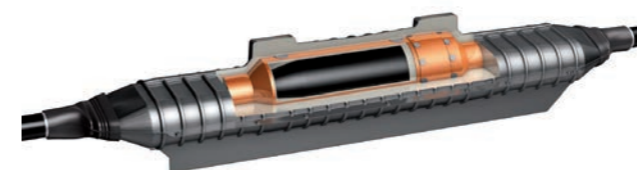

Product description	Conductor cross section (mm ²)	Diameter over cable insulation (prepared) (mm)	Max. diameter over outer cable sheath (mm)	Length (mm)	Diameter (mm)	Screen treatment
EHVS-145TH	185 - 1600	43 - 83	105	3000	350	Inline / shield break / grounded
EHVS-145TH	1600 - 2500	60 - 112	130	3000	450	Inline / shield break / grounded

Three Piece Joints 170 kV

Heat-shrink Rejacketing



Product description	Conductor cross section (mm ²)	Diameter over cable insulation (prepared) (mm)	Max. diameter over outer cable sheath (mm)	Length (mm)	Diameter (mm)	Screen treatment
EHVS-170TW	240 - 2500	60 - 112	130	2000	250	Inline / shield break / grounded

Copper Casing



Product description	Conductor cross section (mm ²)	Diameter over cable insulation (prepared) (mm)	Max. diameter over outer cable sheath (mm)	Length (mm)	Diameter (mm)	Screen treatment
EHVS-170TC	240 - 2500	60 - 112	130	2500	300	Inline / shield break / grounded

Coffin Box



Product description	Conductor cross section (mm ²)	Diameter over cable insulation (prepared) (mm)	Max. diameter over outer cable sheath (mm)	Length (mm)	Diameter (mm)	Screen treatment
EHVS-170TB	240 - 2500	60 - 112	130	3000	450	Inline / shield break / grounded

Heavy Duty (Copper Casing and Coffin Box)

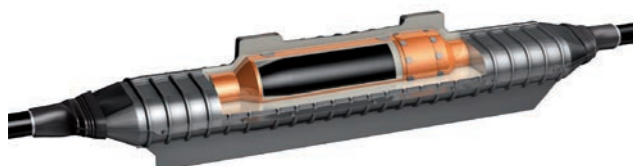

Product description	Conductor cross section (mm ²)	Diameter over cable insulation (prepared) (mm)	Max. diameter over outer cable sheath (mm)	Length (mm)	Diameter (mm)	Screen treatment
EHVS-170TH	240 - 2500	60 - 112	130	3000	450	Inline / shield break / grounded

Fibre-Optic Add-On Kit for HV Cable Joints

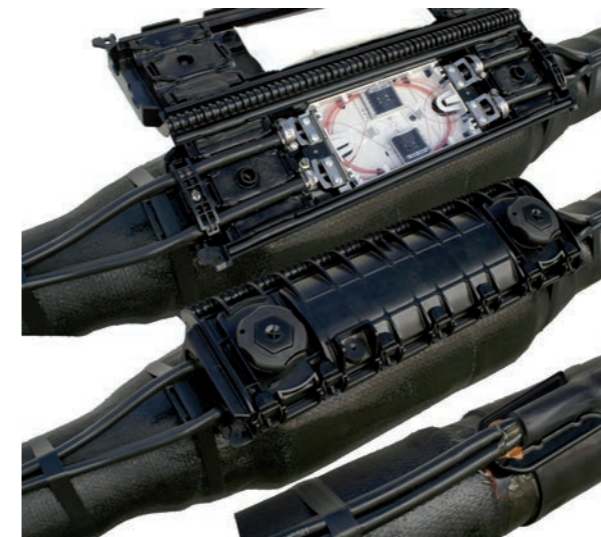

APPLICATIONS

- The TE's Raychem fibre-optic add-on kit is designed to connect the glass fibres integrated in HV cables. The kit includes all components required to seal the cable jacket and the fibre-optic outlet securely and to protect the sensitive optical fibres that are housed inside the steel pipes
- The standard add-on kit is suitable for connecting two individual steel pipes each with a maximum of 24 optical fibres

FEATURES

- The splice box is suitable for cross-bonding and straight-through joints
- Gel-sealing technology ensures reliable operation even when buried joints are used
- Enhanced fibre management
- The splice box is easy to open and close without the use of special tools
- The kits are available for all TE's Raychem joints



Link Boxes

TE's high voltage linkboxes HVLB provides a sealed and dry environment for high voltage cable sheath earthing connection. It eliminates or reduces voltages and circulating currents.

Through our modular system we can provide any technical marketable configuration. A well-arranged best-in-class configuration ensures upmost reliability.

Homogeneous distances between the electrical path, trustworthy electrical connections and a special developed short-circuit-yoke ensure the very best impulse-voltage 65 kV and short-circuit [63 kA/1sec.] withstand.

For safety in an unexpected case, our box is tested to absorb the power of an internal arc with 25 kA for 0.1 sec.

To get an easy access to the cable sheath for inspections, TE developed a reliable gasket-lid-system, which is absolutely-tight (IP68) against water and dust. The lid system is equipped with a proof device for padlocks to prevent unauthorized access.

Gland sealing with WCSM heat shrinking tube is the very reliable basic design. On demand we supply also screw cable glands (IP68) and for additional safety a new developed cable gland sealwall.

Additional Devices:

- Pedestrian device
- Plexi-Cover (Protection against electrical contact)

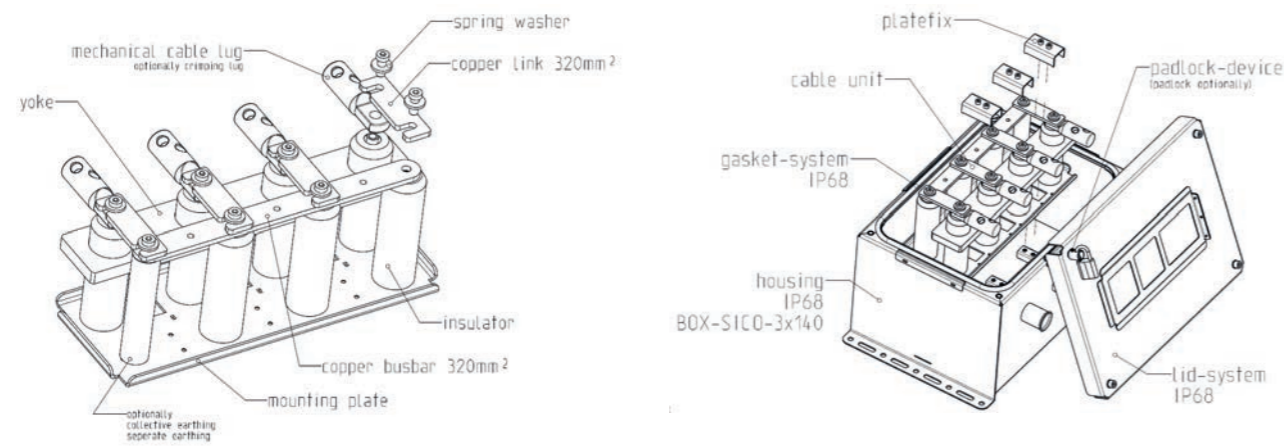

HVLB-SICO-1E



- Dimension 326 x 431 x 320
- Single core cable
- Protection class IP68
- Removable links

HVLB-SICO-2E HVLB-SICO-UNI



- Dimension 466 x 431 x 320
- For universal usage (Grounding, SVL and Cross-bonding)
- Single core cable
- Protection class IP68
- Removable links

HVLB-SICO-3E



- Dimension 606 x 431 x 320
- Single core cable
- Protection class IP68
- Removable links

SICO-GND

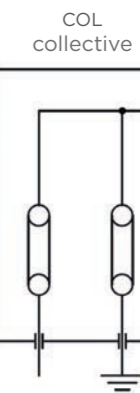
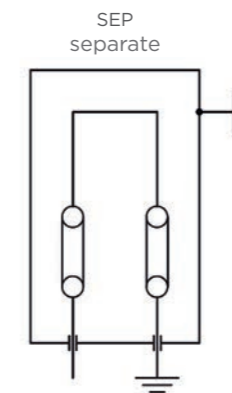

SICO-SVL

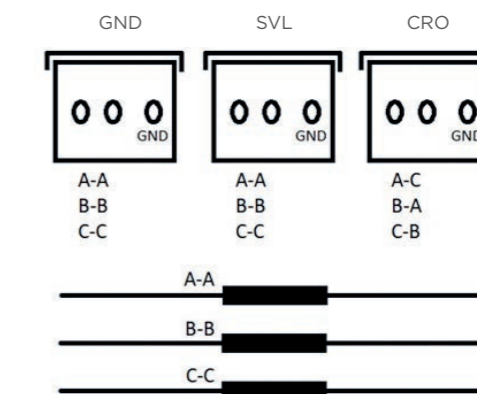
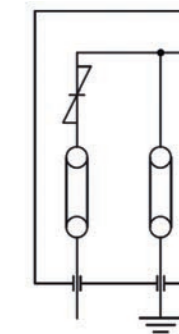
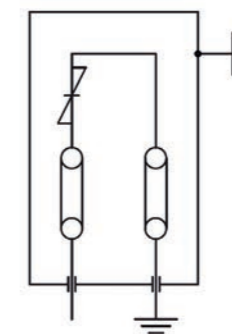

SICO-GND

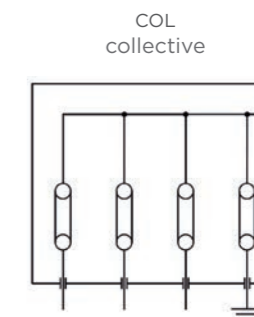
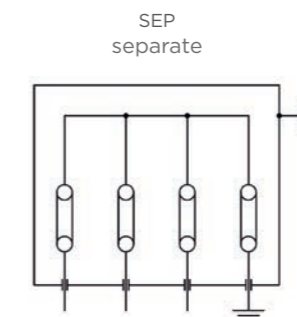

SICO-SVL

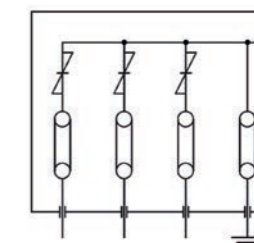
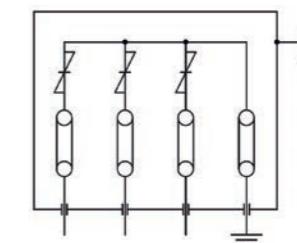

HVLB-SICO-4E



- Dimension 466 x 431 x 460
- For grounding
- Single core cable
- Protection class IP68
- Removable links

HVLB-SICO-4iiE



- Dimension 466 x 601 x 460
- Single core cable
- Protection class IP68
- Removable links

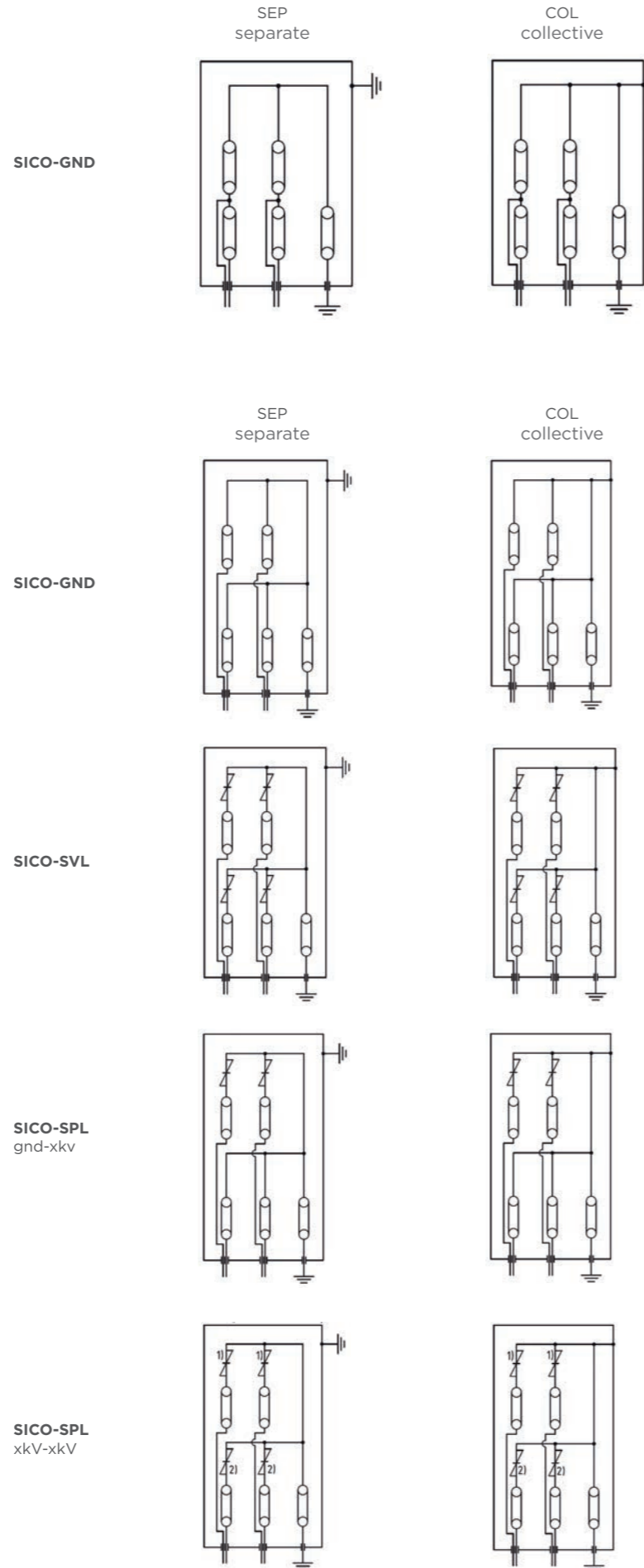

HVLB-SICO-6E



- Dimension 606 x 431 x 320
- Single core cable
- Protection class IP68
- Removable links

HVLB-SICO-6iiE



- Dimension 606 x 401 x 460
- Single core cable
- Protection class IP68
- Removable links

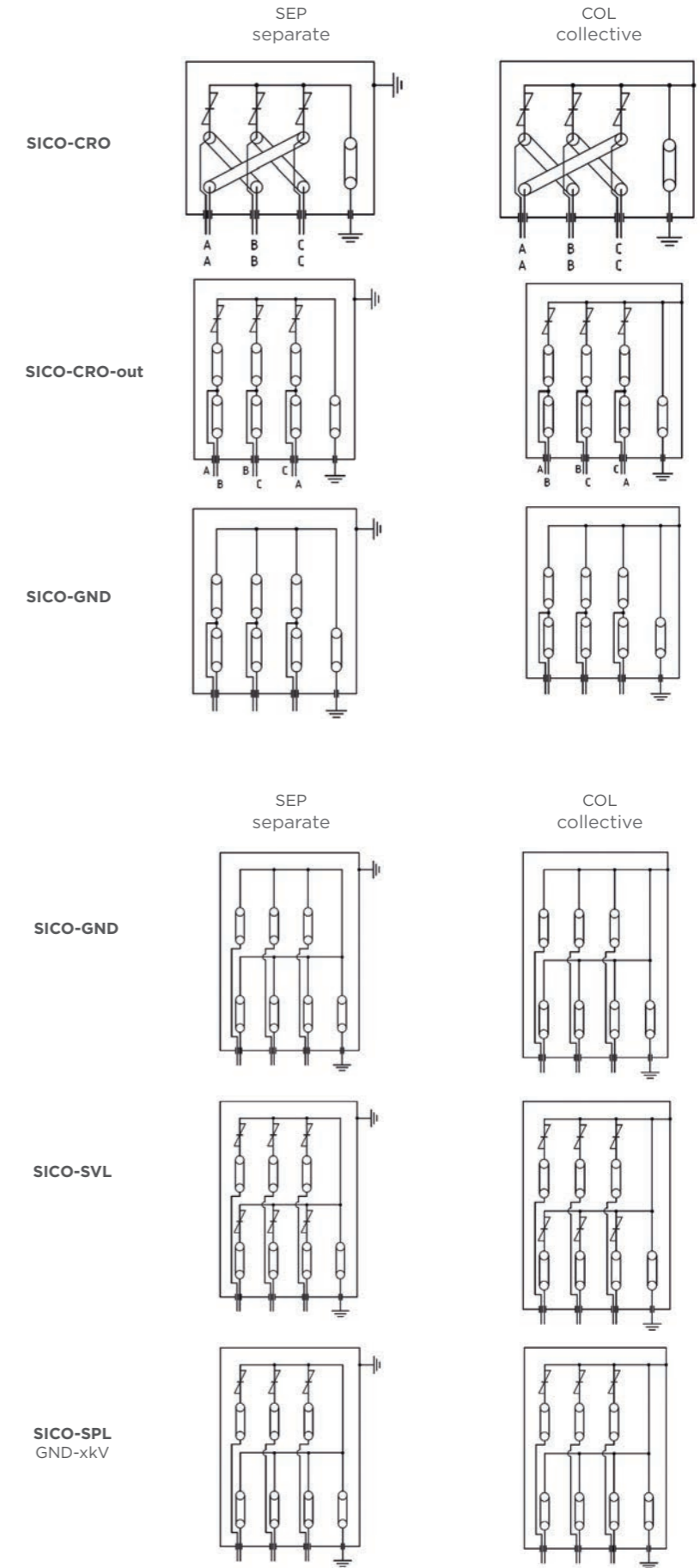

SICO-SPL
xkV-xkV

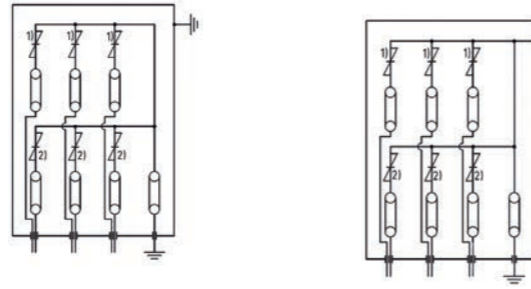

HVLB-COAX



- Dimension 821 x 498 x 446
- Coaxial cable
- Protection class IP68
- Removable links

COAX-GND

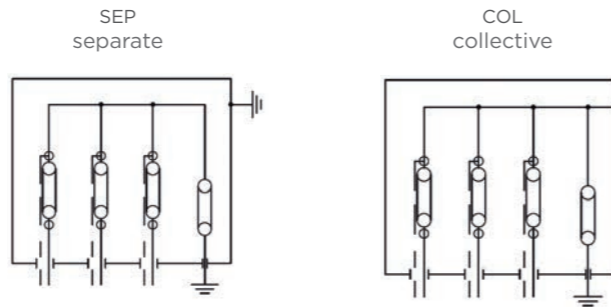

COAX-SVL

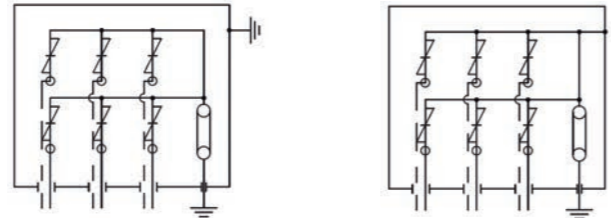

COAX-CRO

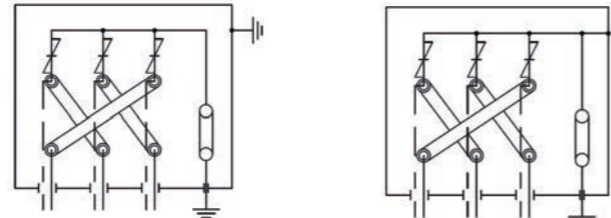

COAX-SPL
GND-xkV

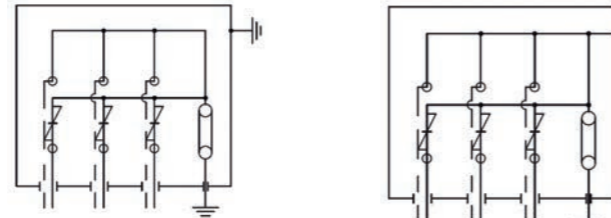

COAX-SPL
xkV-xkV

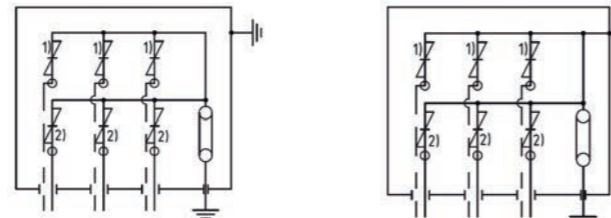

EPPA-055-Link Boxes

U-Niveau	Family	Class	Mechanical dimensions		Electrical dimensions		
			Busbar crosssection (mm ²)	Distance phases (mm)	Impulse voltage (kV)	Short circuit current	Power arc internal
6 -30 kV	EPPA-055	IP68	120	35	35	-	-
6 -30 kV	EPPA-055	IP56	120	35	35	-	-

Available Material				Available Painting	
A2	SS304 / 4301	X5CrNi18-10	Drinking water resistance	without	Sandblasted



Features

- Electrically and mechanically type tested
- 1-phase and 3-phase boxes
- With or without surge arresters
- With or without removable links

Link Diagram



Bonding lead (type)	Single-core	Single-core
Bonding lead (mm ²)	95 - 300	95 - 300
Protection class	IP 56 or IP 68	IP 56 or IP 68
Application	Non buried	Non buried
Sheath voltage limiters	N/A	1 kV - 6 kV
Box size L x H x W (mm)	310 x 255 x 310	310 x 255 x 310
Material	Stainless steel	Stainless steel
Total weight	Approx. 16 kg	Approx. 16 kg
Connection links	Copper 120 mm ²	Copper 120 mm ²
Cable connection	Compression lug	Compression lug
Impulse withstand voltage (kV)	35	35
AC withstand voltage (kV)	24	24
DC withstand voltage (kV)	40	40
Short circuit current (kA/1s)	-	-
Description	EPPA-055-0-3	EPPA-055-x*-3

* Indicates voltage class of sheath voltage limiter (SVL)

Link Diagram



Bonding lead (type)	Single-core	Single-core
Bonding lead (mm ²)	95 - 300	95 - 300
Protection class	IP 56 or IP 68	IP 56 or IP 68
Application	Non buried	Non buried
Sheath voltage limiters	N/A	1 kV - 6 kV
Box size L x H x W (mm)	310 x 255 x 310	310 x 255 x 310
Material	Stainless steel	Stainless steel
Total weight	Approx. 16 kg	Approx. 16 kg
Connection links	Copper 120 mm ²	Copper 120 mm ²
Cable connection	Compression lug	Compression lug
Impulse withstand voltage (kV)	35	35
AC withstand voltage (kV)	24	24
DC withstand voltage (kV)	40	40
Short circuit current (kA/1s)	-	-
Description	EPPA-055-0-3	EPPA-055-x*-3

* Indicates voltage class of sheath voltage limiter (SVL)

Link Diagram



Bonding lead (type)	Single-core	Single-core
Bonding lead (mm ²)	95 - 300	95 - 300
Protection class	IP 56 or IP 68	IP 56 or IP 68
Application	Non buried	Non buried
Sheath voltage limiters	N/A	1 kV - 6 kV
Box size L x H x W (mm)	310 x 255 x 310	310 x 255 x 310
Material	Stainless steel	Stainless steel
Total weight	Approx. 16 kg	Approx. 16 kg
Connection links	Copper 120 mm ²	Copper 120 mm ²
Cable connection	Compression lug	Compression lug
Impulse withstand voltage (kV)	35	35
AC withstand voltage (kV)	24	24
DC withstand voltage (kV)	40	40
Short circuit current (kA/1s)	-	-
Description	EPPA-055-0-3	EPPA-055-x*-3

* Indicates voltage class of sheath voltage limiter (SVL)

Link Diagram

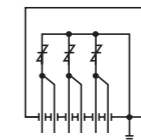

Bonding lead (type)	Single-core
Bonding lead (mm ²)	95 - 300
Protection class	IP 56 or IP 68
Application	Non buried
Sheath voltage limiters	1 kV - 6 kV
Box size L x H x W (mm)	310 x 255 x 310
Material	Stainless steel
Total weight	Approx. 16 kg
Connection links	Copper 120 mm ²
Cable connection	Compression lug
Impulse withstand voltage (kV)	35
AC withstand voltage (kV)	24
DC withstand voltage (kV)	40
Short circuit current (kA/1s)	-
Description	EPPA-055-x*-3

* Indicates voltage class of sheath voltage limiter (SVL)

Link Diagram



Bonding lead (type)	Single-core	Single-core
Bonding lead (mm ²)	95 - 300	95 - 300
Protection class	IP 56	IP 56
Application	Non buried	Non buried
Sheath voltage limiters	N/A	1 kV - 6 kV
Box size L x H x W (mm)	300 x 165 x 190	300 x 165 x 190
Material	Stainless steel	Stainless steel
Total weight	Approx. 10 kg	Approx. 11 kg
Connection links	Removable copper 120 mm ²	Removable copper 120 mm ²
Cable connection	Compression lug	Compression lug
Impulse withstand voltage (kV)	35	35
AC withstand voltage (kV)	24	24
DC withstand voltage (kV)	40	40
Short circuit current (kA/1s)	-	-
Description	EPPA-055-0-1	EPPA-055-x*-1

* Indicates voltage class of sheath voltage limiter (SVL)



Chapter IV Connectors & Fittings

AutoPress L62 Hydraulic Crimping Tool	104
Insulation Piercing Connectors	106
Shear Bolt Terminal Lugs and Connectors	107
Copper Lugs Longitudinally Sealed	110
Bimetallic Lugs for Aluminium Conductors	111
Copper Tubular Terminals and Splices	112
Waterproof Pre-insulated Mechanical Connectors	116
Anchor and Suspension Clamps for Service Cables	117
Anchor Clamps for Self Supporting LV-ABC Lines	118
Suspension Clamps for Self Supporting LV-ABC Lines	119
Anchor Clamps for LV-ABC Lines with Insulated Neutral Messenger	120
Shear Bolt Type Mechanical Connectors	121

AutoPress L62 Hydraulic Crimping Tool

FEATURES

- The AUTOPRESS L62 press is designed for indentation or hexagonal crimping of the following connectors:
- 'C' type connectors (from C6 TO C50)
- XCT, XTX, XCT.EQ copper tubular lugs, Terminal connectors and XG7T copper joint sleeves from 6 to 400 mm²
- DIN copper lugs / sleeves from 10 to 240 mm²

APPLICATIONS

- To press and crimp few types of connectors

BENEFITS

- Ergonomic design and light weight allows crimping to be done one handed
- Electronic speed control in the trigger
- Quick opening and closing head, 180° rotating head with hydraulic pressure off
- Possibility of using D62 dies in 130 kN tools like SIMABLOC C120+ type and Autopress C120
- Automatic release with an audible "click" when force of 62 kN is reached. Return of piston by releasing the trigger
- A 18 V 1.5 Ah battery is delivered with the tool. Battery with power load indicator. About 120 crimping operations possible before recharging

SELECTION INFORMATION: DIMENSIONS SHOWN IN MILLIMETERS

Product references



XCT/XCT.C



XCT.EQ



XG7T

Designation Tcpn	Type
AutoPress 62 in carrying case with 1 battery w/o led and one hour charger	2107725-1
Battery 1.5 Ah	2107576-4
Battery 3.0 Ah	2107576-2
"30 minute" charger	2107607-2

Crimping die selection (depending on connectors)
 This hydraulic press is designed to take 6E..., 6R... type dies. The list below is not exhaustive.



UniPress 6-120



Autopress 80



Autopress C120

Cross-sectional Area (mm ²)	Die Reference	TCPN
6	6E6 Cu	1667700-1
10	6E10 Cu	1667701-1
16	6E16 Cu	1667702-1
25	6E25 Cu	1667703-1
35	6E35 Cu	1667704-1
50	6E50 Cu	1667705-1
70	6E70 Cu	1667706-1
95	6E95 Cu	1667707-1
120	6E120 Cu	1667708-1
150	6E150 Cu	1667709-1
185	6E185-Cu	1667710-1
240	6E240Cu	1667711-1
300	6E300Cu	2107737-1
400	6E400Cu	2107738-1

Insulation Piercing Connectors

FEATURES

- Insulation Piercing Connectors (IPCs) provide electrical connection for aluminum and copper stranded conductors without stripping and removing insulation from the conductors

APPLICATIONS

- During installation the IPC establishes electrical contact, protects, and seals the contact interface, and electrically insulates the connection, eliminating the need for weather-proofing and re-insulating.
- PX/KZ/DZ Piercing Connector are suitable for 1 kV & below insulated cables and suitable for Aluminium conductor, Copper conductor and Copper-Aluminium transition.
- MV Insulation Piercing Connectors are suitable for 10 kV overhead line and suitable for aluminium conductor, Copper conductor and copper-aluminium transition
- Flame Retardant (FR) Insulation Piercing Connector are suitable for 1 kV & below insulated cables and suitable for Aluminium conductor, Copper conductor and Copper-Aluminium transition.

BENEFITS

- Wide conductor range, bare and insulated cables, and suitable for aluminum and copper conductors
- Shear-head design ensures good contact properties and avoids damaging cables
- Blades made of special tinned copper or harden Aluminium alloy
- Low torque, easy to install, no special tools necessary
- Quick, reliable, and safe connections on energized conductors (not under load)
- Excellent insulation and sealing performance ensures the IPCs performance in corrosive environment
- Flame retardant UL94-V0 class, halogen free for bodies, sealing and end cap (Only for FR IPCs)



SELECTION INFORMATION: DIMENSIONS SHOWN IN MILLIMETERS

1 kV IPC Selection Table

Conductor (mm ²)		Description	Screw Qty	Shear Head Size	Rated Current (A)	L x W x H (MM)
Main	Tap					
16-95	04-35	KZ2-95	1	13	138	52 x 47 x 87
50-150	06-35	KZ2-150	1	13	138	52 x 47 x 87
25-95	25-95	KZ3-95	1	13	207	61 x 52 x 93
50-150	50-150	KZ4-95	1	13	239	61 x 52 x 93
120-240	25-120	DZ6	1	17	239	68 x 42 x 100

1 kV IPC Selection Table

Main (mm ²)	Tap (mm ²)	Description	Screw Qty	Shear Head Size	Rated Current (A)	L x W x H (MM)
16-95	16-70	MV95/70	1	13	320	95 x 61 x 52
95-240	35-95	MV240/95	1	13	393	129 x 80 x 55
120-240	95-185	MV240/185	1	17	600	130 x 84 x 62
185-300	150-240	MV300/240	2	17	712	135 x 84 x 121

1 kV FR IPC Selection Table

Conductor (mm ²)		Description	Screw Qty	Shear Head Size	Rated Current (A)	L x W x H (MM)
Main	Tap					
16-95	4-35	FR KZ2-95	1	13	138	52 x 47 x 87
50-150	6-35	FR KZ2-150	1	13	138	52 x 47 x 87
25-95	25-95	FR KZ3-95	1	13	207	61 x 52 x 93
50-150	50-150	FR KZ4-150	1	13	239	61 x 52 x 93
120-240	25-120	FR DZ6	1	17	239	68 x 42 x 100

Shear Bolt Terminal Lugs and Connectors

FEATURES

- TE Connectivity's Shear Bolt connectors are range-taking mechanical terminal connectors. Just six connectors will accommodate a wide range of aluminum and copper conductors from 25 mm² stranded and solid to 500 mm² circular stranded class 2.
- Just six connectors will accommodate a wide range of aluminum and copper conductors from 25 mm² stranded and solid to 500 mm² circular stranded class 2.

APPLICATIONS

- Used for low and medium voltage application up to 42 kV
- Shear Bolt connectors are ideally suited for aluminum to aluminum, aluminum to copper and copper to copper applications making them the universal connector solution
- The only tool required to install the connector is a standard ratchet wrench with the appropriate sized hexagonal sockets. The connector design incorporates shear head bolts, which ensures that the correct torque is applied
- The removable inserts in the connector body centralize smaller conductor sizes. For larger sizes, inserts are not required and are easily removed with a standard screwdriver. Shear Bolt connectors meet the electrical and mechanical requirements IEC 61238-1.
- A holding tool is recommended to avoid core bending of conductors and can be ordered from TE Connectivity

BENEFITS

- Bodies and bolts made of special aluminium alloy provide good contact properties
- Compact design requires little installation space, particularly for large sizes
- No elongation during installation, make it easier to design relevant accessories
- Chamfered edges are suitable for up to 42 kv voltage and adaptable to existing termination designs
- Shear bolts with predetermined shear torque ensures that the correct torque is applied to each bolt and consequently to the end of each conductor
- The connector design incorporates shear head bolts, which ensures that the correct torque is applied to each bolt and consequently the optimal contact force is generated to minimize connection resistance
- The removable inserts in the connector body centralize smaller conductor sizes



SELECTION INFORMATION: DIMENSIONS SHOWN IN MILLIMETERS

Lugs Dimensions

Product Reference	Cross-sectional Range (mm ²)	Palm hole Diameter mm LB	Dimensions mm				Contact Bolts Quantity	Head Size AF (mm)
			L1	L2	L3	L4		
BLMT-25/95-13	25-95	13	60	30	24	12.8	1	13
BLMT-25/95-17	25-95	17	60	30	24	12.8	1	13
BLMT-35/150-13	35-150	13	86	35	28	15.8	1	17
BLMT-35/150-17	35-150	17	86	35	28	15.8	1	17
BLMT-95/240-13	95-240	13	112	60	33	20	2	19
BLMT-95/240-17	95-240	17	112	60	33	20	2	19
BLMT-120/300-13	120-300	13	115	65	37	24	2	22
BLMT-120/300-17	120-300	17	115	65	37	24	2	22
BLMT-185/400-13	185-400	13	137	80	42	25.5	3	22
BLMT-185/400-17	185-400	17	137	80	42	25.5	3	22
BLMT-185/400-21	185-400	21	137	80	42	25.5	3	22
BLMT-500/630-13	500-630	13	150	95	50	33	3	27
BLMT-500/630-17	500-630	17	150	95	50	33	3	27
BLMT-500/630-21	500-630	21	150	95	50	33	3	27

Application Information: Dimensions in metrics

Product Reference		Application Range Conductor Type						
		Al Circular Stranded	Al Circular Solid	Al Sector Stranded	Al Sector Solid	Cu Circular Stranded	Cu Circular Solid	Cu Sector Stranded
BLMT-25/95-XX	Cross-sectional range (mm ²)	25 - 95	25 - 95	25 - 70	-	16 - 95	10 - 50	25 - 70
	Cross-sectional range (mm ²)	-	-	95**	-	-	-	95**
	Conductor diameter (mm)	5.7 - 12.5	5.5 - 11	-	-	4.8 - 12.5	3.6 - 8	-
BLMT-35/150-XX	Cross-sectional range (mm ²)	35 - 150	35 - 150	50 - 95	50 - 120	35 - 150	35 - 50	50 - 95
	Cross-sectional range (mm ²)	-	-	120* - 150**	-	-	-	120* - 150**
	Conductor diameter (mm)	6.8 - 15	6.5 - 14	-	-	6.6 - 15	6.5 - 8	-
BLMT-95/240-XX	Cross-sectional range (mm ²)	95 - 240	95 - 240	95 - 150	95 - 150	95 - 240	-	95 - 150
	Cross-sectional range (mm ²)	-	-	185* - 240**	185(90°)	-	-	185* - 240**
	Conductor diameter (mm)	11 - 19.2	10.5 - 18	-	-	11 - 19.2	-	-
BLMT-120/300-XX	Cross-sectional range (mm ²)	120 - 300	150 - 300	120 - 185	120 - 240	120 - 300	-	120 - 185
	Cross-sectional range (mm ²)	-	-	240* - 300**	-	-	-	240* - 300**
	Conductor diameter (mm)	12.7 - 23.1	12.9 - 19.8	-	-	12.7 - 22.6	-	-
BLMT-185/400-XX	Cross-sectional range (mm ²)	185 - 400	185 - 400	185 - 240	185 - 240	185 - 400	-	185 - 240
	Cross-sectional range (mm ²)	-	-	300* - 400**	300(90°)	-	-	300* - 400**
	Conductor diameter (mm)	15.5 - 24.6	14.8 - 24.6	-	-	15.5 - 24.6	-	-
BLMT-500/630-XX	Cross-sectional range (mm ²)	500 - 630	500 - 630	-	-	500 - 630	-	-
	Cross-sectional range (mm ²)	-	-	-	-	-	-	-
	Conductor diameter (mm)	25.3 - 32.5	24.0 - 28.6	-	-	25.3 - 32.5	-	-

*	Slightly rounded with pliers
**	Pressed round
XX	Palm hole

Product Reference	Cross-sectional Range (mm ²)	Blocked	Dimensions mm				Contact Bolts Quantity	Head Size AF mm
			L1	L2	L3	L4		
BSMB-10/35	10-35	yes	45 20	19	8.5	2	10	25 - 70
BSM-25/95	25-95	yes	65 30	24	12.8	2	13	95**
BSM-25/95-U	25-95	no	65	24	12.8	2	13	-
BSMB-35/150	35-150	yes	80 35	28	15.8	2	17	50 - 95
BSMU-35/150	35-150	no	80	28	15.8	2	17	120* - 150**
BSM-95/240	95-240	yes	125 60	33	20	4	19	-
BSM-95/240-U	95-240	no	125	33	20	4	19	95 - 150
BSMB-95/240-34	95-240	yes	125 60	34	22	4	19	185* - 240**
BSMB-120/300	120-300	yes	140 65	37	24	4	22	-
BSMU-120/300	120-300	no	140	37	24	4	22	120 - 185
BSM-185/400	185-400	yes	170 80	42	25.5	6	22	240* - 300**
BSM-185/400-U	185-400	no	170	42	25.5	6	22	-
BSMB-500	500	yes	190 90	46	30	6	27	185 - 240
BSMU-500	500	no	190 90	46	30	6	27	300* - 400**
BSMB-630	630	yes	200 95	50	33	6	27	-

*	Slightly rounded with pliers
**	Pressed round

Product Reference		Application Range Conductor Type						
		Al Circular Stranded	Al Circular Solid	Al Sector Stranded	Al Sector Solid	Cu Circular Stranded	Cu Circular Solid	Cu Sector Stranded
BSMB-10/35	Cross-sectional range (mm ²)	10 - 35	10 - 50	10 - 25	10 - 35	10 - 35	10 - 35	10 - 25
	Cross-sectional range (mm ²)	-	-	35**	-	-	-	35**
	Conductor diameter (mm)	3.7 - 7.5	3.4 - 7.8	-	-	3.7 - 7.5	3.4 - 6.7	-
BSM-25/95 BSM-25/95-U	Cross-sectional range (mm ²)	25 - 95	25 - 95	25 - 70	-	16 - 95	10 - 50	25 - 70
	Cross-sectional range (mm ²)	-	-	95**	-	-	-	95**
	Conductor diameter (mm)	5.7 - 12.5	5.5 - 11	-	-	4.8 - 12.5	3.6 - 8	-
BSMB-35/150 BSMU-35/150	Cross-sectional range (mm ²)	35 - 150	35 - 150	50 - 95	50 - 120	35 - 150	35 - 50	50 - 95
	Cross-sectional range (mm ²)	-	-	120* - 150**	-	-	-	120* - 150**
	Conductor diameter (mm)	6.8 - 15	6.5 - 14	-	-	6.6 - 15	6.5 - 8	-
BSM-95/240 BSM-95/240-U	Cross-sectional range (mm ²)	95 - 240	95 - 240	95 - 150	95 - 150	95 - 240	-	95 - 150
	Cross-sectional range (mm ²)	-	-	185* - 240**	185(90°)	-	-	185* - 240**
	Conductor diameter (mm)	11 - 19.2	10.5 - 18	-	-	11 - 19.2	-	-
BSMB-95/240-34	Cross-sectional range (mm ²)	95 - 240	95 - 240	95 - 150	95 - 185	95 - 240	-	95 - 150
	Cross-sectional range (mm ²)	-	-	185 - 240*	-	-	-	185 - 240*
	Conductor diameter (mm)	11 - 20.8	10.5 - 18	-	-	11 - 19.2	-	-
BSMB-120/300 BSMU-120/300	Cross-sectional range (mm ²)	120 - 300	150 - 300	120 - 185	120 - 240	120 - 300	-	120 - 185
	Cross-sectional range (mm ²)	-	-	240* - 300**	-	-	-	240* - 300**
	Conductor diameter (mm)	12.7 - 23.1	12.9 - 19.8	-	-	12.7 - 22.6	-	-
BSM-185/400 BSM-185/400-U	Cross-sectional range (mm ²)	185 - 400	185 - 400	185 - 240	185 - 240	185 - 400	-	185 - 240
	Cross-sectional range (mm ²)	-	-	300* - 400**	300(90°)	-	-	300* - 400**
	Conductor diameter (mm)	15.5 - 24.6	14.8 - 24.6	-	-	15.5 - 24.6	-	-
BSMB-500 BSMU-500	Cross-sectional range (mm ²)	500	500	-	-	500	-	-
	Cross-sectional range (mm ²)	-	-	-	-	-	-	-
	Conductor diameter (mm)	25.3 - 28.9	24 - 25.1	-	-	25.3 - 28.6	-	-
BSMB-630	Cross-sectional range (mm ²)	630	630	-	-	630	-	-
	Cross-sectional range (mm ²)	-	-	-	-	-	-	-
	Conductor diameter (mm)	28.7 - 32.5	27.3 - 28.4	-	-	28.7 - 32.5	-	-

Copper Lugs Longitudinally Sealed

FEATURES

- Made of forged electrolytic copper and longitudinally sealed
- Crimp by hexagonal technic
- Conductors sizes: 16 to 400 mm²

APPLICATIONS

- Grounding
- Suitable for outdoor application
- Inside and outside MV and LV terminations for copper cables

BENEFITS

- Wide range for copper cables
- Specially made for high current

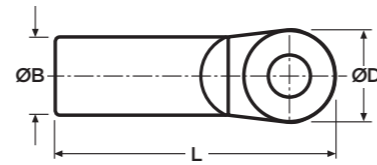
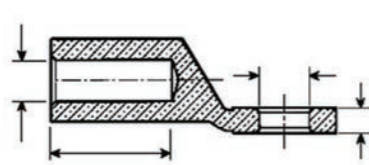

SELECTION INFORMATION: DIMENSIONS SHOWN IN MILLIMETERS

Designation	Cross Section mm ²	PN	RPN	ØA mm	ØB mm	Type 1 ØC mm	ØD mm	Type 2 B mm	F mm	L mm	P mm	Weight (g)	Standard Packaging
DPD7 16	16	0-0709095-1	662374-000	5.5	12.2	25	12.8	-	29	67	5	54	3
DPD7 25	25	0-0709214-1	944560-000	7	12.2	25	12.8	-	29	67	5	44	3
DPD7 25 D14.5	25	0-0709214-2	921506-000	7	12.2	25	14.5	-	29	67	5	44	3
DPD7 25 D16	25	0-0709214-3	159302-000	7	12.2	25	16	-	29	67	5	44	3
DPD7 29	29	0-0709903-1	890200-000	7.8	12.2	25	12.8	-	29	67	5	44	3
DPD7 29/25-D14.5E	29	0-0709290-1	506140-000	7.8	12.2	25	14.5	-	29	67	5	40	10
DPD7 35	35	0-0709215-1	530402-000	8.5	12.2	25	12.8	-	29	67	5	44	3
DPD7 50	50	0-0709216-1	149964-000	9.5	12.2	25	12.8	-	29	67	5	38	3
DPD7 70	70	0-0709086-1	419996-000	12.5	21	30	12.8	-	33	79	6	124	3
DPD7 95	95	0-0709217-1	207728-000	13.5	21	30	12.8	-	33	79	6	118	3
DPD7 120	120	0-0709087-2	461028-000	15	21	35	14.5	-	33	83	7	136	3
DPD7 150	150	0-0709218-2	467958-000	16.5	21	35	14.5	-	33	83	7	124	3
DPD7 185/50x50 NP	185	0-0709088-1	572986-000	19	26	-	-	50	35	104	7	308	3
DPD7 185/50x50 D12	185	0-0709088-3	628460-000	19	26	-	12	50	35	104	7	308	3
DPD7 185/50x50 D14.5	185	0-0709088-5	169076-000	19	26	-	14.5	50	35	104	7	308	3
DPD7 185/50x50 D16	185	0-0709088-6	911388-000	19	26	-	16	50	35	104	7	308	3
DPD7 185/50x50 D18	185	0-0709088-7	-	19	26	-	18	50	35	104	7	308	3
DPD7 240/50x50 NP	240	0-0709219-1	950600-000	21	26	-	-	50	35	104	7	280	3
DPD7 240/50x50 D14.5	240	0-0709219-3	818140-000	21	26	-	14.5	50	35	104	7	280	3
DPD7 240/50x50 D16	240	0-0709219-4	441308-000	23	26	-	16	50	35	104	7	280	3
DPD7 300/60x60 NP	300	0-0709089-1	289358-000	23	32	-	-	60	45	127	9	582	3
DPD7 300/60x60 D14	300	0-0709089-3	542702-000	23	32	-	14	60	45	127	9	582	3
DPD7 300/60x60 D16.5	300	0-0709089-4	141148-000	23	32	-	16.5	60	45	127	9	582	3
DPD7 350/60x60 D14.5	350	0-0709220-1	-	25	32	-	14.5	60	45	127	9	516	3
DPD7 400/60x60 NP	400	0-0709221-1	384642-000	26	32	-	-	60	45	127	9	516	3
DPD7 400/60x60 D14.5	400	0-0709221-2	-	26	32	-	14.5	60	45	127	9	516	3
DPD7 400/60x60 D20	400	0-0709221-4	019968-000	26	32	-	20	60	45	127	9	516	3

Designation	Cross Section mm ²	PN	RPN	ØA mm	ØB mm	Type 1 ØC mm	ØD mm	Type 2 B mm	F mm	L mm	P mm	Weight (g)	Standard Packaging
DPD7 70/50x40 D14E	70	0-0708365-1	288060-000	12.5	21	-	14	50	45	112	7	-	3
DPD7 95/50x40 D14E	95	0-0708366-1	064510-000	13.5	21	-	14	50	45	112	7	-	3
DPD7 185/50x40 D12.8E	185	863114-000	18.5	26	-	12.8	50	45	112	7	-	3	3
DPD7 185/50x40 D18E	185	0-0708367-2	612172-000	18.5	26	-	18	50	45	112	7	-	3
DPD7 240/50x40 D18E	240	0-0708368-1	703690-000	21	26	-	18	50	45	112	7	-	3

Bimetallic Lugs for Aluminium Conductors

FEATURES

- Made of aluminium barrel link to a copper palm by friction welding technology
- Crimp by deep stepped indentation
- Range from 16 to 1600 mm²
- Accept cables according to NFC 32013 and IEC 228

APPLICATIONS

- MV terminations
- LV connection on busbar inside electrical panel
- For external application, the alu-cu area should be protected against humidity

BENEFITS

- One technology for all the sizes of cables
- Single connector model for a given conductor cross-section area
- Friction welding technology
- Age resistant current passage from the aluminium shift to the solid copper plate
- Compliance with specification C33090-1, electrical test performances in accordance,
- with NFC 63-061 class A and IEC 1238-1 class A

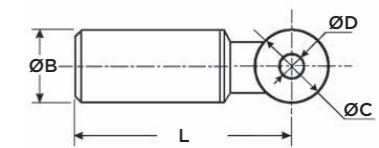

SELECTION INFORMATION: DIMENSIONS SHOWN IN MILLIMETERS

Designation	Cross Section mm ²	PN	RPN	ØA mm	ØB mm	Type 1 ØC mm	ØD mm	Type 2 B mm	F mm
XCX 16	16	0-0719929-1	761570-000	16	20	10.5	72	40	3
XCX 25	25	0-0719930-1	812766-000	16	20	10.5	72	40	3
XCX 35	35	0-0719924-1	005880-000	16	25	12.8	73.5	45	3
XCX 50	50	0-0719923-1	203304-000	20	25	12.8	73.5	65	3
XCX 70	70	0-0719922-1	224166-000	20	25	12.8	73.5	65	3
XCX 95	95	0-0719921-1	831348-000	20	25	12.8	73.5	60	3
XCX 120	120	0-0719782-1	288864-000	25	30	12.8	94	130	3
XCX 150	150	0-0719783-1	128036-000	25	30	12.8	94	125	3
XCX 185	185	0-0739006-1	558578-000	32	30	12.8	94	210	3
XCX 240	240	0-0739007-1	117094-000	32	30	12.8	94	200	3
XCX 300	300	0-1306957-1	341018-000	40	36	16.5	137	380	3
XCX 400	400	0-1306962-1	140868-000	40	36	16.5	137	340	3
XDX 500	500	0-0708270-1	-	47	60 x 60	*	200	860	3
XDX 630	630	0-0708270-2	063918-000	47	60 x 60	4 Ø 9 30	200	800	3
XDX 800	800	0-0708273-1	867280-000	60	80 x 80	*	260	-	3
XDX 1000	1000	0-0708273-2	655044-000	60	80 x 80	*	260	-	3
XDX 1200	1200	0-0708275-1	587504-000	65	80 x 80	4 Ø 11 40	271	-	3
XDX 1600	1600	-	-	70	125 x 125	9 Ø 11 45	322	-	3

Copper Tubular Terminals and Splices

General Description

FEATURES

- XCT Tubular terminals and XG7T splices are ideally suited to connect electrical copper wire to equipment's terminals or to another conductor. XCT and XG7T range includes
- XCT and XG7T range includes ring tongue terminals, right angle terminals, compact narrow tongue terminal and splices
- Made of highly conductive electrolytic copper with a bright tin finish, the full range can be used for rigid stranded wire (Class 2) and flexible wires (Class 5)
- The wire size and stud holes are clearly marked in metric sizes
- The connection can be realized with either hexagonal or indent crimping tools
- Indent crimping tool Unipress 6-120 and Hexagonal crimping tool Autopress L62 have been tested and qualified to install XCT and XG7T terminals and splices

APPLICATIONS

- To make connection to Terminal equipments or other conductors

BENEFITS

- Full range for cross section conductors from 1.5 mm² to 630 mm²
- A funnel entry design and an inspection hole ensure easy of handling
- Offer outstanding resistance to oxidation and corrosion
- Compliance with NFC 20 130 French Standard

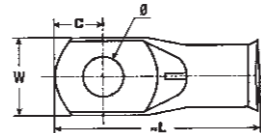
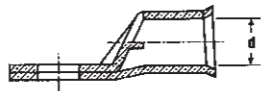

SELECTION INFORMATION: DIMENSIONS SHOWN IN MILLIMETERS

Designation	PN	RPN	Capacity (mm ²)	Dimensions (mm)					Stud M	Weight (kg)	Standard Packaging	
				Ø	W	d	C	L				
XCT 1,5-3	0-0710971-1	747476-000	1,5	3,2	6	1,8	3,25	17	3	0,0007	100	
XCT 1,5-4	0-0710972-1	583886-000		4,3	6,5	1,8	4	17	4	0,0009	100	
XCT 1,5-5*	0-0710973-1	264854-000		5,3	7,5	1,8	4,75	18	5	0,0009	100	
XCT 1,5-6*	0-0711674-1	338120-000		6,4	9	1,8	6,5	19	6	0,0010	100	
XCT 2,5-4	0-0710974-1	527554-000	2,5	4,3	8	2,2	4,5	18	4	0,0013	100	
XCT 2,5-5	0-0710975-1	146900-000		5,3	8,5	2,2	5	19	5	0,0013	100	
XCT 2,5-6*	0-0710976-1	380270-000		6,4	9	2,2	6,5	20	6	0,0015	100	
XCT 4-4	0-0710977-1	612772-000	4	4,3	9	2,7	4,75	21	4	0,0024	100	
XCT 4-5	0-0710978-1	898102-000		5,3	9	2,7	4,75	24	5	0,0026	50	
XCT 4-6	0-0710979-1	665128-000	6	6,4	12	2,7	6,5	25	6	0,0027	50	
XCT 6-4	0-0710032-1	977850-000		4,2	10	3,3	7	31	4	0,0043	100	
XCT 6-5	0-0710032-2	350506-000		5,2	10	3,3	7	31	5	0,0043	100	
XCT 6-6	0-0710032-4	107672-000		6,4	13	3,3	7	31	6	0,0044	100	
XCT 6-8	0-0710032-6	588770-000	10	8,3	13	3,3	9	35	8	0,0045	100	
XCT 10-4*	0-0710031-1	007658-000		4,2	11	4,2	7	33	4	0,0060	100	
XCT 10-5	0-0710031-2	484566-000		5,2	11	4,2	7	33	5	0,0065	100	
XCT 10-6	0-0710031-4	522246-000		6,4	11	4,2	7	33	6	0,0065	100	
XCT 10-8	0-0710031-6	246220-000		8,3	14	4,2	10	38	8	0,0074	100	
XCT 10-10	0-0710031-8	234052-000	16	10,3	14	4,2	10	38	10	0,0075	100	
XCT 16-5	0-0710030-1	894412-000		5,2	12	5,3	7	33,5	5	0,0086	100	
XCT 16-6	0-0710030-3	025722-000		6,4	12	5,3	7	33,5	6	0,0087	100	
XCT 16-8	0-0710030-5	657484-000		8,3	16	5,3	9	39	8	0,0092	100	
XCT 16-10	0-0710030-7	204354-000		10,3	16	5,3	11	43	10	0,0099	100	
XCT 16-12*	0-0710030-8	634476-000		12,8	16	5,3	11	43	12	0,0094	100	
XCT 25-5*	0-0710026-1	477850-000		25	5,2	13	6,6	7	35	5	0,0108	100
XCT 25-6	0-0710026-3	592958-000			6,4	13	6,6	7	35	6	0,0110	100
XCT 25-8	0-0710026-5	572356-000			8,3	16	6,6	9	40	8	0,0117	100
XCT 25-10	0-0710026-7	428136-000			10,3	16	6,6	11	44	10	0,0116	100
XCT 25-12*	0-0710026-8	081140-000			12,2	16	6,6	11	44	12	0,0120	100
XCT 35-6	0-0710027-1	118978-000		35	6,4	15	7,9	7	39	6	0,0140	50
XCT 35-8	0-0710027-2	415846-000			8,3	17	7,9	11	46	8	0,0150	50
XCT 35-10	0-0710036-3	792910-000			10,3	17	7,9	11	46	10	0,0171	50
XCT 35-12*	0-0710036-4	186864-000			12,8	17	7,9	11	46	12	0,0154	50
XCT 50-6*	0-0710025-3	326608-000		50	6,4	18	9,2	13,5	53	6	0,0200	25
XCT 50-8	0-0710025-2	392352-000	8,3		18	9,2	13,5	53	8	0,0260	25	
XCT 50-10	0-0710025-5	361896-000	10,3		18	9,2	13,5	53	10	0,0300	25	
XCT 50-12	0-0710025-7	375724-000	60	12,8	19	9,2	13,5	53	12	0,0230	25	
XCT 60-8*	0-0709817-1	059648-000		8,3	19	10,5	11,3	52,5	8	0,0218	25	
XCT 60-10	0-0709817-2	344944-000		10,3	19	10,5	11,3	52,5	10	0,0202	25	
XCT 60-12	0-0709817-3	604036-000		12,8	19	10,5	13,8	52,5	12	0,0200	25	
XCT 70-8	0-0710028-1	554532-000	70	8,3	21	11	13,5	58	8	0,0396	25	
XCT 70-10	0-0710028-3	348884-000		10,3	21	11	13,5	58	10	0,0374	25	
XCT 70-12	0-0710028-5	357652-000		12,8	21	11	13,5	58	12	0,0376	25	
XCT 70-16*	0-0710028-8	922802-000		16,5	21	11	16,5	60,5	16	0,0362	25	

Designation	PN	RPN	Capacity (mm ²)	Dimensions (mm)					Stud M	Weight (kg)	Standard Packaging	
				Ø	W	d	C	L				
XCT 1,5-3	0-0710971-1	747476-000	1,5	3,2	6	1,8	3,25	17	3	0,0007	100	
XCT 1,5-4	0-0710972-1	583886-000		4,3	6,5	1,8	4	17	4	0,0009	100	
XCT 1,5-5*	0-0710973-1	264854-000		5,3	7,5	1,8	4,75	18	5	0,0009	100	
XCT 1,5-6*	0-0711674-1	338120-000		6,4	9	1,8	6,5	19	6	0,0010	100	
XCT 2,5-4	0-0710974-1	527554-000	2,5	4,3	8	2,2	4,5	18	4	0,0013	100	
XCT 2,5-5	0-0710975-1	146900-000		5,3	8,5	2,2	5	19	5	0,0013	100	
XCT 2,5-6*	0-0710976-1	380270-000		6,4	9	2,2	6,5	20	6	0,0015	100	
XCT 4-4	0-0710977-1	612772-000	4	4,3	9	2,7	4,75	21	4	0,0024	100	
XCT 4-5	0-0710978-1	898102-000		5,3	9	2,7	4,75	24	5	0,0026	50	
XCT 4-6	0-0710979-1	665128-000	6	6,4	12	2,7	6,5	25	6	0,0027	50	
XCT 6-4	0-0710032-1	977850-000		4,2	10	3,3	7	31	4	0,0043	100	
XCT 6-5	0-0710032-2	350506-000		5,2	10	3,3	7	31	5	0,0043	100	
XCT 6-6	0-0710032-4	107672-000		6,4	13	3,3	7	31	6	0,0044	100	
XCT 6-8	0-0710032-6	588770-000	10	8,3	13	3,3	9	35	8	0,0045	100	
XCT 10-4*	0-0710031-1	007658-000		4,2	11	4,2	7	33	4	0,0060	100	
XCT 10-5	0-0710031-2	484566-000		5,2	11	4,2	7	33	5	0,0065	100	
XCT 10-6	0-0710031-4	522246-000		6,4	11	4,2	7	33	6	0,0065	100	
XCT 10-8	0-0710031-6	246220-000		8,3	14	4,2	10	38	8	0,0074	100	
XCT 10-10	0-0710031-8	234052-000	16	10,3	14	4,2	10	38	10	0,0075	100	
XCT 16-5	0-0710030-1	894412-000		5,2	12	5,3	7	33,5	5	0,0086	100	
XCT 16-6	0-0710030-3	025722-000		6,4	12	5,3	7	33,5	6	0,0087	100	
XCT 16-8	0-0710030-5	657484-000		8,3	16	5,3	9	39	8	0,0092	100	
XCT 16-10	0-0710030-7	204354-000		10,3	16	5,3	11	43	10	0,0099	100	
XCT 16-12*	0-0710030-8	634476-000		12,8	16	5,3	11	43	12	0,0094	100	
XCT 25-5*	0-0710026-1	477850-000		25	5,2	13	6,6	7	35	5	0,0108	100
XCT 25-6	0-0710026-3	592958-000			6,4	13	6,6	7	35	6	0,0110	100
XCT 25-8	0-0710026-5	572356-000			8,3	16	6,6	9	40	8	0,0117	100
XCT 25-10	0-0710026-7	428136-000			10,3	16	6,6	11	44	10	0,0116	100
XCT 25-12*	0-0710026-8	081140-000			12,2	16	6,6	11	44	12	0,0120	100
XCT 35-6	0-0710027-1	118978-000		35	6,4	15	7,9	7	39	6	0,0140	50
XCT 35-8	0-0710027-2	415846-000			8,3	17	7,9	11	46	8	0,0150	50
XCT 35-10	0-0710036-3	792910-000			10,3	17	7,9	11	46	10	0,0171	50
XCT 35-12*	0-0710036-4	186864-000			12,8	17	7,9	11	46	12	0,0154	50
XCT 50-6*	0-0710025-3	326608-000		50	6,4	18	9,2	13,5	53	6	0,0200	25
XCT 50-8	0-0710025-2	392352-000	8,3		18	9,2	13,5	53	8	0,0260	25	
XCT 50-10	0-0710025-5	361896-000	10,3		18	9,2	13,5	53	10	0,0300	25	
XCT 50-12	0-0710025-7	375724-000	60	12,8	19	9,2	13,5	53	12	0,0230	25	
XCT 60-8*	0-0709817-1	059648-000		8,3	19	10,5	11,3	52,5	8	0,0218	25	
XCT 60-10	0-0709817-2	344944-000		10,3	19	10,5	11,3	52,5	10	0,0202	25	
XCT 60-12	0-0709817-3	604036-000		12,8	19	10,5	13,8	52,5	12	0,0200	25	
XCT 70-8	0-0710028-1	554532-000	70	8,3	21	11	13,5	58	8	0,0396	25	
XCT 70-10	0-0710028-3	348884-000		10,3	21	11	13,5	58	10	0,0374	25	
XCT 70-12	0-0710028-5	357652-000		12,8	21	11	13,5	58	12	0,0376	25	
XCT 70-16*	0-0710028-8	922802-000		16,5	21	11	16,5	60,5	16	0,0362	25	

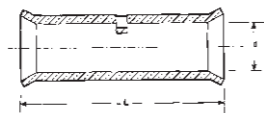

Designation	PN	RPN	Capacity (mm ²)	Dimensions (mm)		Weight (kg)	Standard Packaging
				d	L		
XG7T 1,5	0-0710982-1	522928-000	1,5	1,8	15	0,0012	100
XG7T 2,5	0-0710983-1	984046-000	2,5	2,2	18	0,0013	100
XG7T 4	0-0710984-1	914422-000	4	2,7	22	0,0031	100
XG7T 6	0-0709834-1	016836-000	6	3,3	31	0,0040	50
XG7T 10	0-0709835-1	062518-000	10	4,2	39	0,0040	50
XG7T 16	0-0709836-1	845692-000	16	5,3	39	0,0103	50
XG7T 25	0-0709837-2	929958-000	25	6,6	39	0,0128	50
XG7T 35	0-0709838-1	516670-000	35	7,9	39	0,0169	50
XG7T 50	0-0709839-1	977042-000	50	9,2	50	0,0262	25
XG7T 60	0-0709840-1	232750-000	60	10,5	47	0,0170	25
XG7T 70	0-0709841-1	961138-000	70	11	52	0,0390	25
XG7T 95	0-0709842-1	513764-000	95	13,1	65	0,0564	25
XG7T 120	0-0709843-1	120650-000	120	14,5	71	0,0780	10
XG7T 150	0-0709844-1	263742-000	150	16,2	78	0,1015	10
XG7T 185	0-0709845-1	918180-000	185	18	86	0,1250	10
XG7T 240	0-0709846-1	610494-000	240	20,6	94	0,1660	10
XG7T 300	0-0709847-1	597942-000	300	23,1	102	0,1802	5
XG7T 400	0-0709574-1	246948-000	400	26	102	0,2062	5

XCT--EQ Right angle Terminals

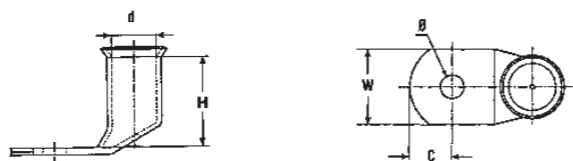

Designation	PN	RPN	Capacity (mm ²)	Dimensions (mm)					Stud M	Weight (kg)	Standard Packaging
				Ø	W	d	C	H			
XCT 6-6 EQ	0-0708470-1	331510-000	6	6,5	13	3,3	7,5	14,4	6	-	100
XCT 10-6 EQ	0-0708471-1	476454-000	10	6,5	11	4,2	6,5	12,2	6	0,0050	100
XCT 10-8 EQ	0-0708471-2	318714-000		8,5	12	4,2	10	12,2	8	0,0060	100
XCT 16-6 EQ	0-0708472-1	267314-000	16	6,5	12	5,3	6,25	13	6	0,0070	100
XCT 16-8 EQ	0-0708472-2	736286-000		8,5	16	5,3	9	12,8	8	0,0080	100
XCT 25-6 EQ	0-0708412-1	862906-000	25	6,5	13	6,6	6,25	13,5	6	0,0117	100
XCT 25-8 EQ	0-0708412-2	545748-000		8,5	16	6,6	10	13,5	8	0,0132	100
XCT 35-6 EQ	0-0708473-1	391712-000	35	6,5	15	7,9	7,5	14	6	0,0163	50
XCT 35-8 EQ	0-0708473-2	349164-000		8,5	17	7,9	10	14,5	8	0,0140	50
XCT 35-10 EQ	0-0708473-3	108500-000		10,5	17	7,9	12	22	10	-	50
XCT 50-6 EQ	0-0708474-1	517876-000	50	6,5	17	9,2	6,25	28	6	-	50
XCT 50-8 EQ	0-0708474-2	475098-000		8,5	18	9,2	10	18,3	8	0,0288	25
XCT 50-10 EQ	0-0708474-3	352900-000		10,5	18	9,2	12	18,5	10	0,0242	25
XCT 70-10 EQ	0-0708476-1	412716-000	70	10,5	21	11	12	19,5	10	0,0398	25
XCT 70-12 EQ	0-0708476-2	955970-000		13	21	11	13	19,5	12	-	25
XCT 95-10 EQ	0-0708477-1	690846-000	95	10,5	23	13,1	12	35	10	-	25
XCT 95-12 EQ	0-0708477-2	406338-000		13	23	13,1	13	35	12	0,0400	25
XCT 120-10 EQ	0-0708478-1	838050-000	120	10,5	28	14,5	12	38	10	-	25
XCT 150-12 EQ	0-0708479-1	002186-000	150	13	28	16,2	15	40	12	-	10

Other dimensions on request.

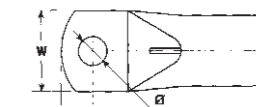

Designation	PN	RPN	Capacity (mm ²)	Dimensions (mm)					Stud M	Weight (kg)	Standard Packaging
				Ø	W	d	C	L			
XCT,C 120-10	0-0708461-1	458994-000	120	10,3	24,5	14,3	11,5	63	10	0,0644	25
XCT,C 150-10	0-0708462-1	913502-000	150	10,3	24,5	16	11,5	64,5	10	0,0800	10
XCT,C 185-10	0-0708463-1	691256-000	185	10,3	24,5	17,8	11,5	72,5	10	0,0980	10
XCT,C 240-10	0-0708464-1	666084-000	240	10,3	31	20,4	11,5	74	10	0,1230	10
XCT,C 300-10	0-0708465-1	499082-000	300	10,3	31	22,9	11,5	83	10	0,1380	10

Other dimensions on request.

In case of use with flexible conductor,
it is necessary to use next larger section :
- Ex : flexible wire 35 mm²: use the lug (or sleeve) with marking: 50 mm²

Waterproof Pre-insulated Mechanical Connectors

FEATURES

- These waterproof insulated mechanical connectors are suitable for all types of LV-ABC conductors as well as connections to service and lighting cable cores

APPLICATIONS

- They are used when a customer service line is changed or reconnect to a customer after payment. End cap is included to seal open sides.
- The bolts (13 mm) are being tightened until the heads shear off
- Available with a piercing contact and as second version which requires stripping of the insulation

BENEFITS

- Suitable for aluminium and copper conductors, solid and stranded
- Stripping version can be installed and removed under load (max. 90 A)
- Polymeric tightening bolts allow safe installations on hot lines
- Tested for watertightness at a voltage of 6 kV for 30 min in a waterbath (NFC 33020, CENELEC prEN 50483-4 class 1)
- Exceeds requirements according to NFC 33020, NFC 33021 and NFC 20 540 Components not losable, end cap attached to body
- Stripping version re-openable, piercing version not re-openable
- Insulation material made of weather and UV resistant glass fibre reinforced polymer



SELECTION INFORMATION: DIMENSIONS SHOWN IN MILLIMETERS

Designation	(mm ²) max.	Cross section min.	Type	I _{max.} * (A)	Torque (Nm)	Weight (kg/100 pcs)
BPC 35 -35	35	4	stripping/stripping	90	10	8,5
BPC 35 -P35	35	4	stripping/piercing	90	10	8,5
BPC P35 -P35	35	4	piercing/piercing	-	10	8,5
BPC P50	50	4	stripping/piercing	-	10	8,5

Anchor and Suspension Clamps for Service Cables

& Terminals

FEATURES

- PA 25x100 -The clamp is designed to anchor insulated service lines with 2 or 4 conductors. The clamp is composed of a body, 2 wedges and removable and adjustable bail.
- PA 9-17 and PAS - The clamps are equipped with an adapted wedge for anchoring of round insulated service lines with up to 4 conductors
- RA 25 -The clamp is designed for suspension applications of insulated service lines with 2 or 4 conductors

APPLICATIONS

- PA 25x100
- PA 9-17 and PA
- RA 25

BENEFITS

- Tool free installation with wedges sliding inside the body
- Easy to open bail permits fixing to brackets and pigtails
- Adjustable length of bail in three steps, max. length of clamp 208 mm
- Exceeds requirements according to NF C 33 042
- Clamp made of weather and UV resistant polymer
- Adjustable link made of hot dip galvanized steel
- Adjustable length of bail in four steps, max. length of clamp 220 mm
- For angles of the line up to 90°
- Tool free installation with core separator
- Easy to open bail permits fixing to brackets and pigtails
- Exceeds requirements according to NF C 33 042
- Clamp is made of weather and UV resistant polymer



SELECTION INFORMATION: DIMENSIONS SHOWN IN MILLIMETERS

Anchor clamp for insulated overhead conductors (self-supporting)

Description min.	Cross Section (mm ²) Ordering	max.	Breaking Load (kN)	Weight (kg/10 ks)
PA 25x100	2 x 16	4 x 25	2,0	1,0

Anchor clamps with rigid bail for round cables

Description min.	Cross Section (mm ²) Ordering	max.	Breaking Load (kN)	Weight (kg/10 ks)
PA 25x100	2 x 16	4 x 25	2,0	1,0
PAS 35	18	25	2,0	1,3

Suspension clamp for insulated overhead conductors and cables

Description min.	Cross Section (mm ²) Ordering	max.	Breaking Load (kN)	Weight (kg/10 ks)
RA 25	2 x 16	4 x 25	2,0	0,9

Anchor Clamps for Self Supporting LV-ABC Lines

FEATURES

- The clamps are designed to anchor self supporting LV-ABC lines with 2 to 4 cores

APPLICATIONS

- Single M12 bolt and self-locking nut allow clamp to be fixed also to closed eye screws and bracket
- The wedge type clamp is self-adjusting. Pilot wires or street lighting conductors are led alongside the clamp
- The insertion of conductors is facilitated by an integrated spring which help open the clamp
- The version with movable arms in addition simplifies

BENEFITS

- Exceeds requirements according to ESI 43-14 and VDE 0211 and in future to CENELEC prEN 50483-2
- Clamp made of weather and UV-light resistant glass fibre reinforced polymer and hot dip galvanized steel



SELECTION INFORMATION: DIMENSIONS SHOWN IN MILLIMETERS

Ordering Designation	Cross Section (mm ²)	Breaking Load (kN)	Weight (kg/10 ks)
With fixed arm			
HEL-5505	4 x 10 - 35	12,0	5,2
HEL-5506	4 x 25 - 50	28,0	10,0
HEL-5507	4 x 70 - 95	43,0	11,0
PA 4 120	4 x 120	60,0	20,0
With movable arm			
HEL-5503	4 x 25 - 50	28,0	10,0
HEL-5504	4 x 70 - 95	43,0	11,0

Suspension Clamps for Self Supporting LV-ABC Lines

FEATURES

- The clamps are designed to suspend self supporting LV-ABC lines. They can be also used for LV-ABC lines with bare and insulated neutral messenger

APPLICATIONS

Suspension clamp PS

- Can be installed in straight direction and in line deviation angle up to 30°
- Tool free installation, equipped with wing nut

Universal suspension clamp USC

- Can be installed in straight direction and in line deviation angle up to 40° for 4 x 25 – 50 mm² and up to 20° for 4 x 70 – 120 mm²

Rolling suspension clamp RSC

- Assembly rolls can be used to run out a conductor during line mounting
- Easy to install with a spanner
- Fits to hooks and pigtails up to a diameter of 20 mm

BENEFITS

- Exceeds requirements according to ESI 43-14 and VDE 0211
- Made of weather and UV-light resistant elastomer and hot dip galvanized steel
- Fits to hooks and pigtails up to a diameter of 21 mm
- Operating load 2,5 kN
- Qualified according to CENELEC prEN 50483-2
- Reopen clamp allows easy positioning of the cables
- Fits to all common hooks and pigtails. Not lose parts
- Made of weather and UV-light resistant thermoplastic and steel with Geomet (Chromium free) protection
- Versions with shear head and wing nuts are available on request
- Deviation angle up to 90°
- Not lose parts
- Made of weather and UV-light resistant elastomer and hot dip galvanized steel
- Equipped with a stainless steel reinforced ring in the hook attachment



SELECTION INFORMATION: DIMENSIONS SHOWN IN MILLIMETERS

Ordering Designation	Cross Section (mm ²)	Bundle Diameter (mm)	Breaking Load (kN)	Weight (kg/10 ks)
Suspension clamps				
PS 250/435	2 x 50 - 4 x 35	21 - 25	7,5	4,1
PS 450	2 x 95 - 4 x 50	26 - 30	7,5	3,8
PS 470	4 x 70	31 - 35	7,5	3,6
PS 495	4 x 95	36 - 40	7,5	3,5
PS 4120	4 x 120	40 - 43	7,5	4,4
Universal suspension clamp				
USC 25-120	4 x 25 - 120 + 2 x 25	up to 42	18,0	5,0
Rolling suspension clamp				
RSC 25-120	4 x 25 - 120 + 2 x 25	22 - 42	2,4*	5,0

* Slippage load

Anchor Clamps for LV-ABC Lines with Insulated Neutral Messenger

FEATURES

- The clamps are designed to anchor LV-ABC lines with insulated neutral messenger
- The clamp consists of an aluminium alloy cast body and self-adjusting plastic wedges which clamp the neutral messenger without damaging its insulation
- The clamp and the bracket are available either separately or together as assembly

APPLICATIONS

- The flexible stainless steel bail protected by plastic wear-resistant saddle allows installations of up to 3 clamps on a bracket

BENEFITS

- Tool free installation
- Not lose parts
- Exceeds requirements according to CENELEC prEN 50483-2 and NFC 33 041 and 042
- Clamp body made of corrosion resistant aluminium alloy, bail of stainless steel, wedges of weather and UV resistant polymer
- Universal fixing of bracket by 2 bolts M14 or stainless steel straps of 20 x 0,7 mm.
- Bracket made of corrosion resistant aluminium alloy
- Maximum line deviation angles of 50° for single and 100° for double anchoring:

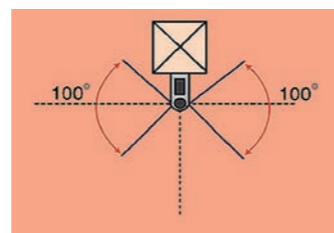
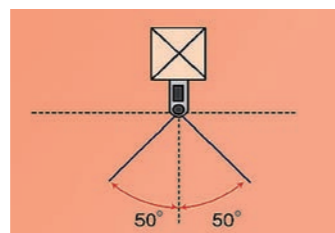
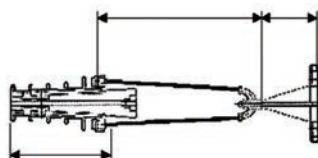

SELECTION INFORMATION: DIMENSIONS SHOWN IN MILLIMETERS

Ordering Designation	Neutral messenger Cross section (mm ²)	Diameter (mm)	Breaking load (kN)	Weight (kg/10 ks)
Anchor clamp without bracket				
PA 1000	25 - 35 8 - 11	10,0	3,2	-
PA 1500x20	50 - 70	12 - 14	15,0	3,4
PA 2000	50 - 70	12 - 14	20,0	4,1
PA 95-2000	95	14 - 16	20,0	4,1
Anchor clamp with bracket				
EA 1000	25 - 35	8 - 11	10,0	5,7
EA 1500	50 - 70	12 - 14	15,0	5,9
EA 2000	50 - 70	12 - 14	20,0	6,4
EA 95-2000	95	14 - 16	20,0	6,4
Bracket				
CA 1500-2	-	-	15,0	2,0
CA 1500/2000	-	-	20,0	2,3

Shear Bolt Type Mechanical Connectors

FEATURES

- TE Connectivity's Shear Bolt connectors are range-taking mechanical connectors
- Just six connectors will accommodate a wide range of aluminum and copper conductors from #2 AWG compact stranded to 1000 kcmil standard stranded class B, from 25 mm² stranded and solid to 500 mm² circular stranded class 2
- Shear Bolt connectors meet the electrical requirements (Class A) of ANSI C119.4 and exceed the mechanical requirements of a class 3 connector by a large margin of safety
- Shear Bolt connectors meet the electrical and mechanical requirements (Class A) of IEC 61238-1
- Shear Bolt connectors are designed to be compatible with TE's Raychem brand cable accessories and insulation products

APPLICATIONS

- The primary application of Shear Bolt connectors is for underground splices up to 42 kV
- Shear Bolt connectors are ideally suited for aluminum to aluminum, aluminum to copper and copper to copper applications making them the universal connector solution.
- The only tool required to install the connector is a standard ratchet wrench with the appropriate sized hexagonal sockets
- The connector design incorporates shear head bolts, which ensures that the correct torque is applied to each bolt and consequently. The optimal contact force is generated to minimize connection resistance
- The solid center stop (available on most sizes) inside the connector ensures proper conductor positioning and eliminates oil leakage when connecting oil impregnated conductors
- Two removable inserts in the connector body centralize smaller conductor sizes. For larger sizes, inserts are not required and are easily removed with a standard screwdriver
- A holding tool is recommended to avoid core bending of conductors and can be ordered from TE Connectivity
- TE's cordless impact wrench can also be used to install the connector. These two convenient and quick tools have been tested and qualified to install Shear Bolt connectors

BENEFITS

- Wide application range up to 1000 kcmil (500 mm²) with just 6 range-taking connectors
- Bodies and bolts made of special aluminium alloy provide good contact properties even if in the connection between copper and aluminium conductors
- Compact design requires little installation space, particularly for large sizes
- No elongation during installation, make it easier to design relevant accessories
- Chamfered edges are suitable for up to 42 kv voltage and adaptable to existing joint designs
- Shear Bolts with predetermined shear torque ensures that the correct torque is applied to each bolt and consequently to the end of each conductor
- Easy installation with standard socket spanner



SELECTION INFORMATION: DIMENSIONS SHOWN IN MILLIMETERS

Catalog Number	Conductor Range	OD Range	Length	Connector O.D.	Stop
ASBS-2-3/0	2 AWG compact stranded to 3/0 AWG standard stranded	268-470 (6.8-11.9)	2.5 (65)	95 (24)	Disc
ASBS-2-350	2 AWG compact stranded to 350 kcmil standard stranded	268-681 (6.8-17.3)	3.9 (100)	1.22 (31)	Solid
ASBS-3/0-500	3/0 AWG compact stranded to 500 kcmil standard stranded	423-813 (10.7-20.6)	4.9 (125)	1.3 (34)	Disc
ASBS-3/0-500-S	3/0 AWG compact stranded to 500 kcmil standard stranded	423-813 (10.7-20.6)	4.9 (125)	1.3 (34)	Solid
ASBS-500-750	500 kcmil compact stranded to 750 kcmil standard stranded	736-998 (18.7-25.3)	6.0 (152)	1.52 (39)	Solid
ASBS-350-750	350 kcmil compact stranded to 750 kcmil standard stranded	616-998 (15.6-25.3)	6.7 (170)	1.67 (42.5)	Solid
ASBS-600-1000	600 kcmil compact stranded to 1000 kcmil standard stranded	813-1.152 (20.6-29.2)	8.0 (203)	1.75 (44.4)	Solid

SELECTION INFORMATION: DIMENSIONS SHOWN IN METRICS

Catalog Number	Conductor Range	OD Range	Length	Connector O.D.	Stop
BSMB-10/35	10 mm ² - 35 mm ²	8.5	45	19	Yes
BSM-25/95	25 mm ² - 95 mm ²	12.8	65	24	Yes
BSM-25/95-U	25 mm ² - 95 mm ²	12.8	65	24	No
BSMB-35/150	35 mm ² - 150 mm ²	15.8	80	28	Yes
BSMU-35/150	35 mm ² - 150 mm ²	15.8	80	28	No
BSM-95/240	95 mm ² - 240 mm ²	20	125	33	Yes
BSM-95/240-U	95 mm ² - 240 mm ²	20	125	33	No
BSMB-95/240-34	95 mm ² - 240 mm ²	22	125	34	Yes
BSMB-120/300	120 mm ² - 300 mm ²	24	140	37	Yes
BSMU-120/300	120 mm ² - 300 mm ²	24	140	37	No
BSM-185/400	185 mm ² - 400 mm ²	25.5	170	42	Yes
BSM-185/400-U	185 mm ² - 400 mm ²	25.5	170	42	No
BSMB-500	500 mm ²	30	190	46	Yes
BSMU-500	500 mm ²	30	190	46	No
BSMB-630	630 mm ²	33	200	50	Yes

APPLICATION INFORMATION: DIMENSIONS IN INCHES

Catalog Number	PII Number*	Socket Size	Test Reports	Conductor Combination
ASBS-2-3/0	408-8990	11/2	Note 1	Note 1
ASBS-2-350	408-8990	11/16	502-47292(I)	4/0 kcmil Cu to 350 kcmil AAC
			502-47300(I)	350 kcmil AAC to 350 kcmil AAC
			502-47340(I)	350 kcmil CU to 350 kcmil CU
ASBS-3/0-500	408-8990	3/4	502-47331(I)	500 kcmil AAC to 500 kcmil AAC
			502-47331(I)	500 kcmil CU to 500 kcmil CU
			502-47331(I)	500 kcmil AAC to 500 kcmil AAC
ASBS-3/0-500-S	408-10429	3/4	502-47331(I)	500 kcmil AAC to 500 kcmil AAC
			502-47331(I)	500 kcmil CU to 500 kcmil CU
ASBS-350-750	408-8990	7/8	502-47329(I)	750 kcmil AAC to 750 kcmil AAC
ASBS-500-750	408-8990	3/4	502-47288(I)	500 kcmil CU to 750 kcmil CU
			502-47294(I)	750 kcmil AAC to 750 kcmil AAC
			502-47289(I)	750 kcmil CU to 1000 kcmil AAC
ASBS-600-1000	408-8990	7/8	502-47344(I)	1000 kcmil CU to 1000 kcmil CU
			502-47305(I)	1000 kcmil AAC to 1000 kcmil AAC

* Installation Instructions Reference Number
 Note: The part number was not tested as ANSI C119.4 allows a smaller size connector of the same design to be added without additional testing.

APPLICATION INFORMATION BY CONDUCTOR TYPE: DIMENSIONS IN METRICS

Catalog Number	Conductor Range	Al Circular stranded	Al Circular solid	Al Sector stranded	Al Sector solid	Cu Circular stranded	Cu Circular solid	Cu Sector stranded
BSMB-10/35	Cross section (sqmm)	10-35	10-50	10-25	10-35	10-35	10-35	10-25
	Cross section (sqmm)	-	-	35**	-	-	-	35**
	Diameter (mm)	3.7-7.5	3.4-7.8	-	-	3.7-7.5	3.4-6.7	-
BSM-25/95 BSM-25/95-U	Cross section (sqmm)	25-95	25-95	25-70	16-95	10-50	25-70	50-95
	Cross section (sqmm)	-	-	95**	-	-	-	95**
	Diameter (mm)	5.7-12.5	5.5-11	-	-	4.8-12.5	3.6-8	-
BSMB-35/150 BSMU-35/150	Cross section (sqmm)	35-150	35-150	50-95	50-120	35-150	35-50	50-95
	Cross section (sqmm)	-	-	120*-150**	-	-	-	120*-150**
	Diameter (mm)	6.8-15	6.5-14	-	-	6.6-15	6.5-8	-
BSM-95/240 BSM-95/240-U	Cross section (sqmm)	95-240	95-240	95-150	95-150	95-240	-	95-150
	Cross section (sqmm)	-	-	185*-240**	185(90°)	-	-	-
	Diameter (mm)	11-19.2	10.5-18	-	-	11-19.2	-	185*-240**
BSMB-95/240-34	Cross section (sqmm)	95-240	95-240	95-150	95-185	95-240	-	95-150
	Cross section (sqmm)	-	-	185-240*	-	-	-	185-240*
	Diameter (mm)	11-20.8	10.5-18	-	11-19.2	-	-	-
BSMB-120/300 BSMU-120/300	Cross section (sqmm)	120-300	150-300	120-185	120-240	120-300	-	120-185
	Cross section (sqmm)	-	-	240*-300**	-	-	-	-
	Diameter (mm)	12.7-23.1	12.9-19.8	-	-	12.7-22.6	-	240*-300**
BSM-185/400 BSM-185/400-U	Cross section (sqmm)	185-400	185-400	185-240	185-240	185-400	-	185-240
	Cross section (sqmm)	-	-	300*-400**	300(90°)	-	-	300*-400**
	Diameter (mm)	5.5-24.6	14.8-24.6	15.5-24.6	-	-	-	-
BSMB-500	Cross section (sqmm)	500	500	-	-	500	-	-
	Diameter (mm)	25.3-28.9	24-25.1	-	-	25.3-28.6	-	-
BSMB-630	Cross section (sqmm)	630	630	-	-	500	-	-
	Diameter (mm)	28.7-32.5	27.3-28.4	-	-	28.7-32.5	-	-

* Slightly rounded with pliers
 Note: Pressed round



Chapter V Wildlife & Asset Protection

BBIT / BPTM Busbar Insulating Tubing	126
HVBT High Voltage Busbar Insulating Tape	127
HVIS High Voltage Busbar Insulating Sheet	129
HVBC High Voltage Cable-to-Bus Insulation	130
HVCE High Voltage Creepage Extenders.....	131
HVCE-WA Wraparound High Voltage Creepage Extenders	132
MVLC Medium Voltage Line Covers.....	133
MVLC-Installation Tools for Overhead Conductors	134
MVCC Medium Voltage Conductor Covers	135
BCAC Distribution Covers for Animal Protection.....	136
BCAC Bushing Connection Animal Covers	137
BCAC-IC Bushing Connection Inspection Substation Covers	138
BCIC Bushing Connection Insulating Covers	139
BCIC Reclosers Covers.....	147
BCIC-115-PH Transmission Flashover Protection Cover.....	148
BCIC-AFD-01 Avian Flight Diverter	148
BCIC Birdcap Protection Covers	149
BISG / BISG-24 Bus Isolation Squirrel Guards.....	151
MVFT Medium Voltage Fusion Tape	152
LVIT Busbar Insulating Tubing (1000 V)	153
HVBS High Voltage Booster Sheds.....	154
RRGS Polymeric and Porcelain Rigid Red Guano Shields.....	154
LVBT Low Voltage Busbar Insulating Heat Shrink Tape.....	155

BBIT / BPTM Busbar Insulating Tubing

FEATURES

- TE's Raychem BBIT/BPTM tubes are extremely flexible which allows for easy positioning
- Have a high expansion ratio, so each size of tubing fits a range of busbar sizes
- Quick installation with the use of a gas torch or oven

APPLICATIONS

- Ideal for protection against accidental bridging caused by birds and other animals
- Can be used on straight or bent bars where clearance reduction or insulation are required
- Ideal for original equipment assembly, and for retrofit applications where access to one end is available

BENEFITS

- Easy installation
- Flexible
- Fits a range of busbar sizes
- Versatile tubing covering a range from 5-35 kV for electrical insulation



PRODUCT SELECTION INFORMATION: DIMENSIONS IN INCHES (MM)

Catalog Number	Rectangular Bar (bus width)	Square Bar (each side)	Round Bar (diameter min-max)	Diameter as Supplied and Fully Recovered
BBIT-25/10-A/U	0.5 (12)	-	0.50-0.70 (12-18)	0.98-0.39 (25-10)
BBIT-40/16-A/U	1.0 (25)	-	0.70-1.10 (18-28)	1.57-0.63 (40-16)
BBIT-65/25-A/U	2.0 (50)	1.0 (25)	1.10-1.55 (28-40)	2.56-0.98 (65-25)
BBIT-100/40-A/U	3.0 (75)	2.0 (50)	1.75-2.45 (44-62)	3.94-1.57 (100-40)
BBIT-150/60-A/U	4.0 (100)	3.0 (75)	2.60-3.60 (66-91)	5.91-2.36 (150-60)
BBIT-175/80-A/U	5.0-6.0 (125-150)	4.0 (100)	3.45-4.75 (88-121)	6.89-3.15 (175-80)
RSRB 4066	120 - 300 mm ²	B17	975801-011	

Catalog Number*	Rectangular Bar		Square Bar		Round Bar		Diameter as Supplied and Fully Recovered
	5 - 15 kV	25 kV	5 - 15 kV	25 kV	5 - 15 kV	25 kV	
BPTM-15/6-A/U	N/A	N/A	N/A	N/A	0.26-0.52 (7-13)	0.26-0.52 (7-8)	0.59-0.24 (15-6)
BPTM-30/12-A/U(B50)	0.25-0.5 (12)		0.5 (12)	0.5 (12)	0.53-0.90 (14-23)	0.53-0.65 (14-16)	1.18-0.47 (30-12)
BPTM-50/20-A/U(B50)	1.0 (25)	1.0 (25)	1.0 (25)	N/A	0.90-1.35 (23-33)	0.90-1.10 (23-28)	1.97-0.79 (50-20)
BPTM-75/30-A/U(B50)	2.0 (50)	2.0 (50)	1.5 (38)	1.0 (25)	1.30-2.00 (33-51)	1.30-1.65 (33-42)	2.95-1.18 (75-30)
BPTM-100/40-A/U(B50)	3.0 (75)	3.0 (75)	2.0 (50)	1.5 (38)	1.75-2.75 (44-70)	1.75-2.30 (44-58)	3.94-1.57 (100-40)
BPTM-120/50-A/U(B50)	4.0-5.0 (100-127)		3.0 (75)	2.0 (50)	2.15-4.00 (55-102)	2.15-3.20 (55-81)	4.72-1.97 (120-50)
BPTM-175/70-A/U(B50)	6.0-7.0 (150-178)	5.0-6.0 (127-150)	4.0 (100)	3.0 (75)	3.20-5.50 (81-140)	3.20-4.40 (81-112)	6.88-2.75 (175-70)
BPTM-205/110-A/U(B50)	8.0 (200)	8.0 (200)	5.0 (127)	4.0 (100)	4.75-7.00 (120-178)	4.75-6.80 (120-174)	8.07-4.33 (205-110)
BPTM-235/130-A/U-C(40)	12 (300)	10 (250)	6.0 (150)	6.0 (150)	5.70-8.45 (145-215)	5.70-8.07 (145-205)	9.25-5.12 (235-130)

* (Bxx) denotes roll of uncoated tubing per box in feet. BPTM-235/130 comes in a box of 132 feet

ADDITIONAL PRODUCT INFORMATION

- Select the appropriate catalog number. Confirm selection with bus dimensions.
- Rectangular bus thickness range is 1/4 to 5/8 inch.
- Bolted connections require two layers of tubing or a fiber bolt pad. (BP-46).
- To environmentally seal the bus at each end of the BBIT tubing, order S1251-50-300-1 or S1251-25-300-4 sealant strip separately.
- Standard package:
 BBIT-25/10-A/U: 65 feet/box BBIT-150/60-A/U: 50 feet/box
 BBIT-40/16-A/U: 60 feet/box BBIT-175/80-A/U: 50 feet/box
 BBIT-65/25-A/U: 50 feet/box BBIT-100/40-A/U: 50 feet/box
 BPTM-235/130-A/U: 132 feet/box All other BPTM sizes: 50 feet/box
 BBIT and BPTM are also available in bulk spooled quantities.
- Related test reports:
 BBIT-UVR-8136, UVR-8137, BPTM-UVR-8019
- Minimum continuous length is 15 feet (4.5 meters).

HVBT High Voltage Busbar Insulating Tape

FEATURES

- Excellent UV resistance
- Insulates up to 35 kV when two layers are applied at 2/3 overlap
- Compatible with all other products in the TE's Raychem medium voltage insulation enhancement system
- Easy to apply using readily available equipment
- Suitable for both indoor and outdoor use
- Excellent anti-tracking properties
- Continuous operating temperature up to 90 °C
- Extremely versatile and flexible at temperatures as low as -40 °C, the 30% shrink ratio enables coverage of almost any shape
- Good thermal emissivity and contact with busbars means no derating is required
- Can be stored indefinitely at temperatures up to 50 °C without loss of performance

APPLICATIONS

- TE's Raychem HVBT tape offers a simple and effective solution to the problems of retrofit insulation of busbars, particularly where existing equipment cannot be dismantled
- Can be used for indoor and outdoor applications and is easily installed over a wide variety of shapes, including complex connections
- May be used in applications 15 kV in accordance with ANSI/IEEE specifications and up to 36 kV in accordance with IEC Specifications

BENEFITS

- Protects against incidental/ accidental bridging caused by birds and animals
- The HVBT adhesive layer fuses the tape layers, but does not stick to the bus or hardware, providing environmental sealing while allowing fast, easy removal
- Manufactured from non-halogen based materials, reducing the toxic and corrosive effects in the event of fire

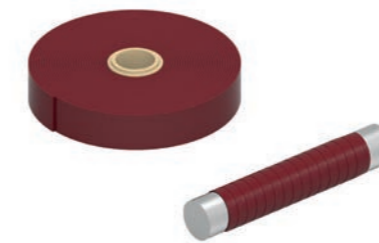

RECTANGULAR BUSBAR

Bus Width* in (mm)	Recommended Product	Bus Length Insulated per Roll feet (meters)
1 (25)	HVBT-1-R-01 (B8)	2.5 (0.7)
2 (50)	HVBT-2-R-01 (B4)	3.3 (1.0)
3 (75)	HVBT-2-R-01 (B4)	2.2 (0.6)
4 (100)	HVBT-2-R-01 (B4)	1.6 (0.5)
6 (150)	HVBT-2-R-01 (B4)	1.0 (0.3)
8 (200)	HVBT-4-R-01 (B2)	1.6 (0.5)

* Calculated with maximum thickness: 5/8 inch (15mm)



SQUARE BUSBAR

Dimensions of bar inch (mm)	Recommended Product	Bus Length Insulated per Roll feet (m)
1 x 1 (25)	HVBT-2-R-01 (B4)	4.0 (1.2)
2 x 2 (50)	HVBT-2-R-01 (B4)	2.0 (0.6)
3 x 3 (75)	HVBT-2-R-01 (B4)	1.3 (0.4)
4 x 4 (100)	HVBT-4-R-01 (B2)	2.0 (0.6)
6 x 6 (150)	HVBT-4-R-01 (B2)	1.3 (0.4)



ROUND BUSBAR

Busbar Diameter inch (mm)	Recommended Product	Bus Length Insulated per Roll feet (m)
0.5 (12)	HVBT-1-R-01 (B8)	5.0 (1.5)
1.0 (25)	HVBT-2-R-01 (B4)	5.0 (1.5)
2.0 (50)	HVBT-2-R-01 (B4)	2.5 (0.7)
3.0 (75)	HVBT-2-R-01 (B4)	1.5 (0.4)
4.0 (100)	HVBT-4-R-01 (B2)	2.5 (0.7)

PRODUCT SELECTION INFORMATION:

Catalog Number	Roll Width Roll Length	Standard Package
HVBT-1-R-01 (B8)	1 inch 25 feet	8 rolls/box
HVBT-2-R-01 (B4)	2 inches 25 feet	4 rolls/box
HVBT-4-R-01 (B2)	4 inches 25 feet	2 rolls/box

ADDITIONAL PRODUCT INFORMATION

- Select the appropriate catalog number for the application. Confirm selection with the following recommendations and TE's HVBT tape dimensions:
 - HVBT-1-R is best for short lengths and small bus sizes
 - HVBT-2-R is the most versatile width for general purpose use
 - HVBT-4-R is useful for long lengths and larger bus sizes
- To environmentally seal the bus, order S1251-50-300-1 or S1251-25-300-4 sealant strips separately
- Recommended application is to wrap the tape around the busbar using a two-thirds overlap
- Bolted connections require two layers of tape
- Continuous operating temperature: 90 degrees Celsius
- Related Test reports: UVR-8023, EDR-5154, and EDR-5466

HVIS High Voltage Busbar Insulating Sheet

FEATURES

- TE's Raychem HVIS adhesive coated material provides insulation to Busbar/connections and does not adhere to metal
- Compatible with other Wildlife and Asset Protection products or alone to prevent accidental bridging from birds and animals
- 5-15 kV

APPLICATIONS

- Busbar tees
- Busbar elbows
- Other complex Busbar shapes

BENEFITS

- Easy to install high performance insulation
- Product is UV resistant
- Made of anti-tracking material



PRODUCT SELECTION INFORMATION: DIMENSIONS IN INCHES (MM)

Catalog Number	Width	Length	Packaging
HVIS-05-(B3) NS	26 (660)	20 (508)	Sheet
HVIS-10-(B1) NS	26 (660)	33ft (10m)	Roll

SHEET (HVIS) ACCESSORIES

Catalog Number	Description	Standard Pack
HVIS-Flat (B12)	36" flat bracket for clamping HVIS on straight runs	12 each
HVIS-Angle (B12)	Angle brackets for clamping HVIS at 90 degree angles	12 each
HVIS-Clamp (B25)	Spring clamps to hold brackets on HVIS	25 each

Bus Width	Cut Size Needed	Number of Installations Per HVIS-05 Sheet	Number of Installations per HVIS-10 Roll
T Connection			
1 (25)	11 x 9 (275 x 225)	4	88
2 (50)	13 x 10 (325 x 250)	4	78
3 (75)	16 x 11 (400 x 275)	2	48
4 (100)	18 x 13 (450 x 325)	2	44
6 (150)	22 x 17 (550 x 425)	1	23
Elbow Connection			
1 (25)	11 x 7 (275 x 175)	4	112
2 (50)	13 x 9 (325 x 225)	4	88
3 (75)	15 x 10 (375 x 250)	2	52
4 (100)	18 x 11 (450 x 275)	2	44
6 (150)	22 x 13 (550 x 325)	1	36

ADDITIONAL PRODUCT INFORMATION

- Select the appropriate catalog number. Confirm selection with dimensions.
- Busbars are assumed to be insulated to within one inch of the joint. Cut size should extend a minimum of four inches onto each leg of the joint before shrinking.
- The above table should be used as a guide only; experiment to confirm final cut size. Table is based on 5/8-inch bus thickness period.
- To environmentally seal each leg of the bus, order S1251-50-300-1 or S1251-25-300-4 sealant strips separately.
- HVIS may be rated for applications up to 35kV when two layers are applied
- Standard package: HVIS-05: 3 sheets/box HVIS-10: 1 roll/box

HVBC High Voltage Cable-to-Bus Insulation

FEATURES

- Kit contains heat shrinkable insulating tubing and sealant strips for insulating and environmentally sealing high voltage in-line cable-to-busbar connections
- Kit contains heat shrinkable sealing boot for multiple cable connections

APPLICATIONS

- TE's Raychem HVBC kits are used with TE's high voltage terminations, the diameter build-up over the cable is minimal
- HVBC may be used in applications up to 15 kV in accordance with ANSI/IEEE specifications, and up to 36 kV in accordance with IEC applications

BENEFITS

- Kit greatly simplifies field installation and eliminates the labor and skill needed for tape-and-putty methods
- Increases working space in cramped areas and allows up to four cable connectors



PRODUCT SELECTION INFORMATION:

Catalog Number		Length	Packaging
Bus width: 2 - 4 inches	Bus width: 5 - 6 inches		
HVBC-41	HVBC-61	1	#4-1000 kcmil
HVBC-42	HVBC-62	2	#4-1000 kcmil
HVBC-43	HVBC-63	3	#4-1000 kcmil
HVBC-44	HVBC-64	4	#4-1000 kcmil

Accessory	
BP-46	Fiberglass Bolt Pad (sleeve)

ADDITIONAL PRODUCT INFORMATION

- Select the appropriate catalog number. Confirm selection with dimensions. One HVBC kit insulates one phase of an in-line cable-to-bus connection.
 - Maximum bolt length: 2 inches
 - Maximum busbar thickness: 5/8 inch
 - Maximum bare bus length: 9 inches
- BBIT tubing, BPTM tubing, or HVBT tape, can be used to insulate the exposed busbar before installing the HVBC products
- Shielded cable must be terminated before installing the HVBC products; use TE's HVT terminations
- Standard package: 3 kits/box
- Related test report: EDR-5103

HVCE High Voltage Creepage Extenders

FEATURES

- TE's Raychem HVCE high voltage creepage extenders are heat shrinkable
- Resistant to conventional spray washing techniques
- Will withstand most normal handling, abuse, and extreme weather conditions

APPLICATIONS

- Insulators

BENEFITS

- Increases the flashover performance of insulators by reducing the surface electrical stress and leakage current and increasing the electric strength of the insulators

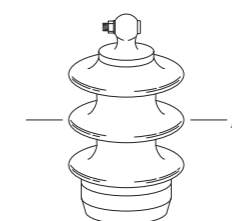

PRODUCT SELECTION INFORMATION: DIMENSIONS IN INCHES (MM)

Catalog Number	Skirt Diameter of Insulator (Min-Max) (A)	Minimum Internal Diameter of HVCE (as supplied)	Creepage Extension Per Extender (mm)	Standard Pack (pcs/box)
HVCE 100/80-01 (B-6)	3.20-3.90 (81-99)	4.50 (114)	101.6	6
HVCE 120/100-01 (B-6)	3.90-4.70 (99-119)	5.30 (135)	101.6	6
HVCE 140/120-01 (B-6)	4.70-5.50 (119-140)	6.10 (155)	101.6	6
HVCE 160/140-01 (B-6)	5.50-6.30 (140-160)	7.00 (178)	101.6	6
HVCE 183/161-01 (B-6)	6.30-7.20 (160-183)	8.00 (203)	101.6	6
HVCE 205/184-01 (B-6)	7.20-8.10 (183-206)	9.00 (229)	101.6	6
HVCE 226/206-11 (B3)	8.10-8.90 (206-226)	9.40 (239)	101.6	3
HVCE 247/227-11 (B3)	8.90-9.70 (226-246)	10.30 (262)	101.6	3
HVCE 268/248-11 (B3)	9.70-10.50 (246-267)	11.10 (282)	101.6	3
HVCE 289/269-11 (B3)	10.50-11.40 (267-290)	11.90 (302)	101.6	3
HVCE 310/290-11 (B3)	11.40-12.20 (290-310)	12.70 (323)	101.6	3
HVCE 331/311-11 (B3)	12.20-13.00 (310-330)	13.60 (345)	101.6	3
HVCE 352/332-11 (B3)	13.00-13.90 (330-353)	14.40 (366)	101.6	3
HVCE 373/353-11 (B3)	13.90-14.70 (353-373)	15.20 (386)	101.6	3
HVCE 394/374-11 (B3)	14.70-15.50 (373-393)	16.10 (409)	101.6	3

ADDITIONAL PRODUCT INFORMATION

- Select the appropriate catalog number. Confirm selection with insulator skirt outer diameter (A)
- Each HVCE extender adds a nominal 4 inches to the creepage length. As a general recommendation, TE advises a 20 percent increase in existing creepage distance. Use this formula to calculate the number of creepage extenders needed: Existing creepage distance in inches x 0.2 / 4 = Minimum number of HVCE creepage extenders recommended (i.e., 40 inches creepage x 0.2 / 4 = 2 HVCE's needed). Always round up to a whole number (i.e., 1.33 to 2 HVCE's)
- For applications that do not fall within the ranges above, contact your local TE representative
- HVCE does not upgrade the voltage class of the insulator
- Related test reports: UVR-8138, UVR-8144, UVR-8037, EDR-5350

HVCE-WA Wraparound High Voltage Creepage Extenders

FEATURES

- TE's Raychem HVCE-WA creepage extender has a wrap-around product design
- Adds six inches of creepage length

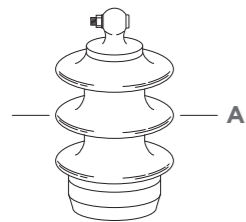

Example of a typical cross section of an HVCE with the dimensions representing that of the insulator profile

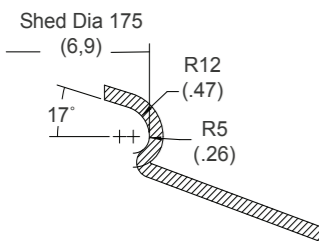

ADDITIONAL PRODUCT INFORMATION

- Each HVCE-WA Extender adds six inches to the creepage length. As a general recommendation, TE advises a 20 percent increase in existing creepage distance. Use this formula to calculate the number of creepage extenders needed:
Existing creepage distance in inches x 0.2/6 = Minimum number of HVCE creepage extenders recommended. (i.e., 60" x .2 / 6 = 2 HVCE-WAs needed). Always round up to a whole number (i.e., 1.33 - 2 HVCE's needed).
- HVCE does not upgrade the voltage class of the insulator
- Related Test Reports: UVR-8152, EDR-5350 Related Installation Instructions: HVCE-WA
- Installation Tool: HVCE-WA-TOOL
- For Applications that do not fall within the ranges above, contact your TE

APPLICATIONS

- Insulators

BENEFITS

- Installs without having to disconnect equipment/conductors
- For use in highly contaminated applications

Catalog Number	Shed Diameter of Insulator (A)	Standard Pack
HVCE-WA-175-02-FT (B6)	6.90 (175)	6
HVCE-WA-206-01 (B6)	8.11 (206)	6
HVCE-WA-216-01 (B6)	8.50 (216)	6
HVCE-WA-221-01 (B6)	8.70 (221)	6
HVCE-WA-226-01 (B6)	8.90 (226)	6
HVCE-WA-227-01 (B6)	8.94 (227)	6
HVCE-WA-234-01 (B6)	9.21 (234)	6
HVCE-WA-244-01-FT (B6)	9.61 (244)	6
HVCE-WA-248-01 (B6)	9.76 (248)	6
HVCE-WA-251-01 (B6)	9.88 (251)	6
HVCE-WA-255-01 (B6)	10.04 (255)	6
HVCE-WA-267-01 (B6)	10.51 (267)	6
HVCE-WA-271-01 (B6)	10.67 (271)	6
HVCE-WA-280-01-FT (B6)	11.02 (280)	6
HVCE-WA-281-01 (B6)	11.06 (281)	6
HVCE-WA-287-01 (B6)	11.30 (287)	6
HVCE-WA-292-01 (B6)	11.50 (292)	6
HVCE-WA-303-01 (B6)	11.93 (303)	6
HVCE-WA-323-01 (B6)	12.72 (323)	6
HVCE-WA-326-01 (B6)	12.83 (326)	6
HVCE-WA-330-01 (B3)	13.00 (330)	3
HVCE-WA-336-01 (B6)	13.23 (336)	6
HVCE-WA-341-01 (B6)	13.39 (341)	6
HVCE-WA-348-01 (B6)	13.70 (348)	6
HVCE-WA-349-01 (B6)	13.74 (349)	6
HVCE-WA-356-01 (B6)	14.02 (356)	6
HVCE-WA-359-01 (B6)	14.13 (359)	6
HVCE-WA-364-01 (B6)	14.33 (364)	6
HVCE-WA-367-01 (B6)	14.45 (367)	6
HVCE-WA-372-01 (B6)	14.65 (372)	6
HVCE-WA-373-01 (B6)	14.68 (373)	6
HVCE-WA-377-01 (B6)	14.84 (377)	6
HVCE-WA-381-01 (B6)	15.00 (381)	6
HVCE-WA-392-01 (B6)	15.43 (392)	6
HVCE-WA-393-01 (B6)	15.47 (393)	6
HVCE-WA-406-01 (B6)	15.98 (406)	6
HVCE-WA-407-01 (B6)	15.98 (407)	6
HVCE-WA-413-01 (B6)	16.26 (413)	6
HVCE-WA-421-01 (B6)	16.54 (421)	6
HVCE-WA-426-01 (B6)	16.77 (426)	6
HVCE-WA-429-01 (B6)	16.89 (429)	6
HVCE-WA-440-01 (B6)	17.32 (440)	6
HVCE-WA-442-01-FT (B6)	17.40 (442)	6
HVCE-WA-452-01 (B6)	17.60 (452)	6
HVCE-WA-457-01 (B6)	18.00 (457)	6
HVCE-WA-463-01 (B6)	18.23 (463)	6
HVCE-WA-482-01 (B3)	18.98 (482)	3
HVCE-WA-488-01 (B6)	19.21 (488)	6
HVCE-WA-490-01 (B6)	19.29 (490)	6
HVCE-WA-501-01 (B6)	19.72 (501)	6

MVLV Medium Voltage Line Covers

FEATURES

- Wrap-around cover
- Installation is possible on energized lines utilizing the MVLV tool which can be manually or automatically operated

APPLICATIONS

- Overhead conductors

BENEFITS

- Prevents electrical outages caused by incidental contact from tree branches or wildlife
- Can be applied selectively on problem spans to avoid costly conductor replacement



PRODUCT SELECTION INFORMATION: DIMENSIONS IN INCHES (MM)

Product Size	Conductor Size	Max. Conductor Dia.	Voltage Class
MVLV-14-A/U-C(100)	#6-3/0 kcmil	0.5 (12.7)	15 kV (sealing mastic in receptacle)
MVLV-14-A/241-C(100)	#6-3/0 kcmil	0.5 (12.7)	25 kV (sealing mastic in receptacle)
MVLV-18-A/U-C(75)	#2-397 kcmil	.75 (18)	15 kV (sealing mastic in receptacle)
MVLV-18-A/241-C(75)	#2-397 kcmil	.75 (18)	25 kV (sealing mastic in receptacle)
MVLV-38R-A/U-C (50)	#2-1590 kcmil	1.375 (35)	15 kV (sealing mastic in receptacle)
MVLV-38R-A/241-C (50)	#2-1590 kcmil	1.375 (35)	25 kV (sealing mastic in receptacle)

MVLV-14

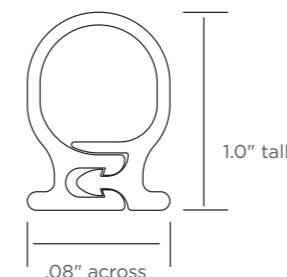

MVLV-18

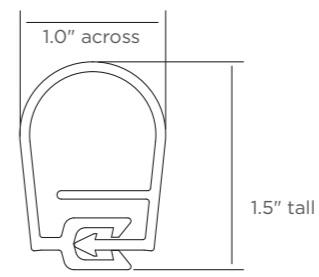

MVLV-38R

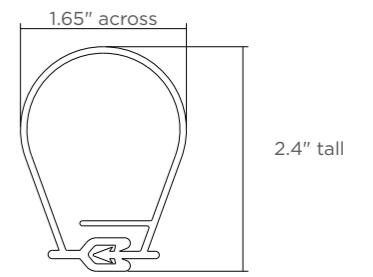

MVLC-Installation Tools for Overhead Conductors



MVLC-HAND-TOOL-14



MVLC-HAND-TOOL-02

Product Size	Conductor Size
MVLC-14-TOOL-100	for use with MVLC-14
MVLC-18-TOOL-03-2006	for use with MVLC-18
MVLC-38R-OHTOOL	for use with MVLC-38R
MVLC-HAND-TOOL-14	hand tool for installing MVLC-14
MVLC-HAND-TOOL-02	hand tool for installing MVLC-18
MVLC-38R-HAND TOOL	hand tool for installing MVLC-38R

ADDITIONAL PRODUCT INFORMATION

- Overhead Conductors: Standard package for MVLC-14 is 330 feet (100m) continuous on a spool. Standard package for MVLC-18 is 247 feet (75m) continuous on a spool.
- Related Test Reports: EDR-5308, EDR-5309, EDR-5316, EDR-5478
- MVLC TOOL contains the MVLC installation tool, MVLC cutters, drainage hole punch, hand crank, and a drive nut socket packaged in a protective bag
- MVLC can be installed at temperatures above 0°C (32°F)

Test	MVLC-A/U / MVLC-A/241 (Sealed)
AC withstand (dry) - 1minute	15 kV min / 25 kV min
AC withstand (wet) - 1 minute	15 kV min / 25 kV min
AC long term withstand (dry) - 4 hours	8.6 kV min / 14.4 kV min
30 day thermal loading (8 hr at 130°; 16 hr off)	No MVLC deformation
Conductor ampacity	82 - 89% of bare conductor ampacity

Material Properties Per pps 3010/42		Test Method	Requirement
Physical	Tensile Strength	ASTM D638	8 Mpa min 1150 psi min
	Ultimate Elongation	ASTM D638	200% min
	Abrasion Resistance	1000 cycles, 2068g	20% max thickness loss No Cracking at -20°C
	Low Temperature Impact	ASTM D746	
Electrical	Dielectric Strength	ASTM D149	217 kV/cm @ 1.27 mm
	Tracking and Erosion Resistance	ASTM D2303 Step Voltage Method (Initiate at 2.5 kV)	550 V/mil min @ 0.050" No tracking or erosion to top surface or flame failure after: 200 minutes

MVCC Medium Voltage Conductor Covers

FEATURES

- Made from non-tracking silicone material TE's Raychem MVCC is suitable for harsh medium voltage outdoor environments
- Covers are split for easy installation
- Four sizes available which fit conductor diameters ranging up to 1.75 inch

APPLICATIONS

- Substation
- Suitable for up to 25 kV phase to ground

BENEFITS

- Provide high quality electrical insulation for substation leads and jumpers
- Flexibility allows installation on tight bends
- Specifically designed to prevent flashover caused by contact with birds and animals



Catalog Number	Conductor Diameter Use Range UOM: inches (mm)	Color	Supplied Length UOM: feet (M)
MVCC-10/.40 (B100)	up to .450 (11)	Red	2 pieces at 50 (15.24)
MVCC-G-10/.40 (B100)	up to .450 (11)	Gray	2 pieces at 50 (15.24)
MVCC-19/.75 (B50)	0.50-0.75 (12-19)	Red	2 pieces at 25 (7.6)
MVCC-G-19/.75 (B50)	0.50-0.75 (12-19)	Gray	2 pieces at 25 (7.6)
MVCC-25/1.0 (B25)	0.75-1.125 (19-28)	Red	1 piece at 25 (7.6)
MVCC-G-25/1.0 (B25)	0.75-1.125 (19-28)	Gray	1 piece at 25 (7.6)
MVCC-45/1.75 x 4 (B24)	1.125-1.75 (28-44)	Red	6 pieces at 4 (1.2)
MVCC-G-45/1.75 x 4 (B24)	1.125-1.75 (28-44)	Gray	6 pieces at 4 (1.2)

ADDITIONAL PRODUCT INFORMATION

- EDR-5461 Medium voltage Conductor Cover Electrical Testing and EDR-5498 Material test

BCAC Distribution Covers for Animal Protection

FEATURES

- TE's Raychem BCAC covers wide range of sizes
- Advanced polymers are rugged, track resistant, UV resistant

APPLICATIONS

- Terminations
- Reclosures
- Lightning arresters
- Fuse Cut-outs

BENEFITS

- Extensive testing has ensured that the cover will not damage or deteriorate the terminations
- Can be installed on energized equipment
- Secured to the stud and the conductor to insure protection even in high winds
- The BCAC-G-CUTOUT is hot-stickable and easily clips onto cutout insulators between first and second skirt

BCAC-AR-5D-2

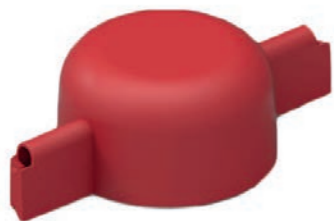

PRODUCT SELECTION INFORMATION

Catalog Number	Hardware
BCAC-P-IC-5D/6 (B6)	Transformer Bushing
BCAC-G-4D/13-2 (B18)	Terminations
BCAC-G-5D/8-01 (B12)	Transformer Bushing
BCAC-G-AR-5D-2 (B24)	Ohio Brass Arrester
BCAC-G-AR-4D-2 (B24)	TE Arrester
BCAC-G-AR-3.75D-2 (B24)	Cooper Arrester
BCAC-G-CUTOUT-100-01-B12	Fuse Cutout Switch (100 AMP) Porcelain style
BCAC-G-CUTOUT-100-P2-B12	100-AMP/Polymeric (Hubbel & Cooper style)
BCAC-G-CUTOUT-FT (B3)	Fuse Cutout Switch (200 AMP) Porcelain style
BCAC-G-CUTOUT-FT-P (B3)	Fuse Cutout Switch (200 AMP) Polymeric style



BCAC-4D/13-2



BCAC-P-IC-5D/6



BCAC-G-CUTOUT-100-01

ADDITIONAL PRODUCT INFORMATION

- Related test reports: EDR-5407 for Bushing covers, EDR-5569 for BCAC-P-IC, EDR-5571 for BCAC-AR, EDR-5573 for cutouts

BCAC Bushing Connection Animal Covers

FEATURES

- Specifically designed to prevent animal caused outages on bushing ranging from 15 to 35 kV
- Fast and easy installation
- Fit wide range of bushings and skirt diameters

APPLICATIONS

- TE's Raychem BCAC protects substation equipment from animal caused outages.

BENEFITS

- Preventing animal-caused outages for years
- Excellent polymer provides long-term performance in all environments (material is rugged, non-tracking, and UV-Resistant)



PRODUCT SELECTION INFORMATION: DIMENSIONS IN INCHES (MM)

Catalog Number	Max Shed Diameter	Cover Height	Color
BCAC-5D/8-01(B12)	4.8 (122)	8.0 (203)	Red
BCAC-7D/10-01(B6)	6.8 (172)	10.5 (266)	Red
BCAC-8D/14-01(B6)	8.0 (203)	14.0 (355)	Red
BCAC-G-5D/8-01(B12)	4.8 (122)	8.0 (203)	Gray
BCAC-G-7D/10-01(B6)	6.8 (172)	10.5 (266)	Gray
BCAC-G-8D/14-01(B6)	8.0 (203)	14.0 (355)	Gray
BCAC-BYPASS-01(B1)*	6.8 (172)	10.6 (266)	Red
BCAC-BYPASS-02(B1)*	8.0 (203)	14.0 (355)	Red

* The BCAC covers are also kitted for voltage regulator applications. The kit includes two bushing covers and a center arrester cover.



ADDITIONAL PRODUCT INFORMATION

- Standard package: 12 or 6 units per box, depending on size of cover. (One BCAC will install on one insulator)
- Related Test Reports: EDR-5339, EDR-5407, UVR-8209

BCAC-IC Bushing Connection Inspection Substation Covers

FEATURES

- Visual inspection of connection and oil levels
- Conductors and leads exit easily through cover
- Robust latching and hinging mechanisms
- Reliable protection with enhanced features
- Good for coverage on equipment up to 35 kV

APPLICATIONS

- TE's Raychem BCAC-IC protects substation equipment from animal caused outages

BENEFITS

- BCAC-IC Insulating covers prevent outages from all types of animals for years
- Fast and easy installation
- Top and side exits for conductor - no need to trim, therefore saving time



PRODUCT SELECTION INFORMATION: DIMENSIONS IN INCHES (MM)

Catalog Number	Standard Pack	Color	Insulator Core Range	Insulator Shed Range	Cover Size	
					Diameter	Height
BCAC-IC						
BCAC-IC-5D/6 (B6)	6	Red	1.5-3.5 (38-89)	2.5-5.0 (63-127)	5.00 (127)	6 (152)
BCAC-IC-7D/12 (B6)	6	Red	3.0-4.87 (76-124)	3.75-7.00 (95-178)	7.00 (178)	12 (305)
BCAC-IC-8D/18 (B6)	6	Red	3.5-6.25 (90-160)	4.00-8.00 (100-200)	8.00 (200)	18 (455)
BCAC-IC-10.5D/20 (B6)	6	Red	3.5-8.5 (90-215)	6-10.5 (150-267)	10.75 (273)	20 (508)
BCAC-G-IC-5D/6 (B6)	6	Gray	1.5-3.5 (38-89)	2.5-5.0 (63-127)	5.00 (127)	6 (152)
BCAC-G-IC-7D/12 (B6)	6	Gray	3.0-4.87 (76-24)	3.75-7.00 (95-178)	7.00 (178)	12 (305)
BCAC-G-IC-8D/18 (B6)	6	Gray	3.5-6.25 (90-160)	4.00-8.00 (100-200)	8.00 (200)	18 (455)
BCAC-G-IC-10.5D/20 (B6)	6	Gray	3.5-8.5 (90-215)	6-10.5 (150-267)	10.75 (273)	20 (508)

Catalog Number	Max Shed Diameter	Cover Height	Color	Insulator Shed Range
BCAC-IC-BYPASS				
BCAC-IC-BYPASS-01 (B1)	7.0 (178)	12.00 (305)	Red	2.5-5.0 (63-127)
BCAC-G-IC-BYPASS-01 (B1)	7.0 (178)	12.00 (305)	Gray	3.75-7.00 (95-178)

The BCAC covers are also kitted for voltage regulator applications. The kit includes two bushing covers and a center arrester cover.

ADDITIONAL PRODUCT INFORMATION

- Related test reports: EDR-5514, UVR-8209

BCIC Bushing Connection Insulating Covers

FEATURES

- Specifically designed to protect energized equipment conductors or busbars from flashovers from contact with birds, squirrels and other wildlife
- Variety of shapes and sizes protect a wide range of applications
- Excellent UV protection and track resistance

APPLICATIONS

- Substations
- Circuit breaker bushings
- Standoff insulators
- Capacitors
- Transformer bushings
- Voltage regulators
- Potential transformers

BENEFITS

- Long life span
- Installation can be done quickly in field by trimming entry and exit holes to required dimensions
- Can be re-entered for other maintenance needs and then reused, lowering overall lifetime costs

PRODUCT SELECTION INFORMATION: DIMENSIONS IN INCHES (MM)

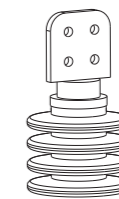
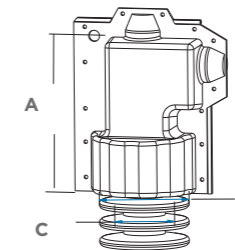
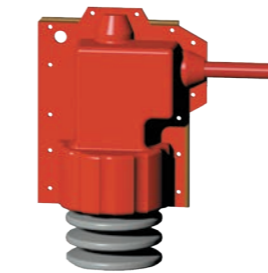

Catalog Number	Height (A)	Base Diameter (B)	Other Measurements (C)	Additional Notes
BCIC-4411 (B3)	10.6 (268)	6.0 (152)	4.0 (102) inner diam.	4 (100) Bottom port opening

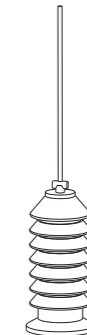
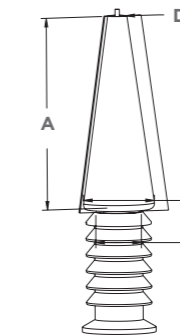

Catalog Number	Height (A)	Base Diameter (B)	Other Measurements (C)	Additional Notes
BCIC-SG-101-H2 (B3)	12 (305)	4.5 (114)	3 (72) inner diam.	(D) 1.125 (29) top diam. Bottom and top opening

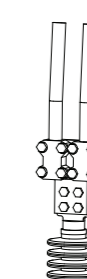
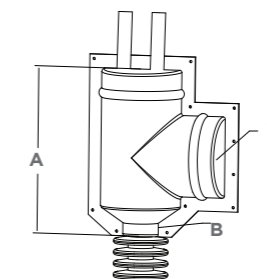

Catalog Number	Height (A)	Base Diameter (B)	Other Measurements (C)	Additional Notes
BCIC-9D/19-3 (B3)	18.5 (470)	4 (102)	9 (229) side diam.	-

PRODUCT SELECTION INFORMATION: DIMENSIONS IN INCHES (MM)

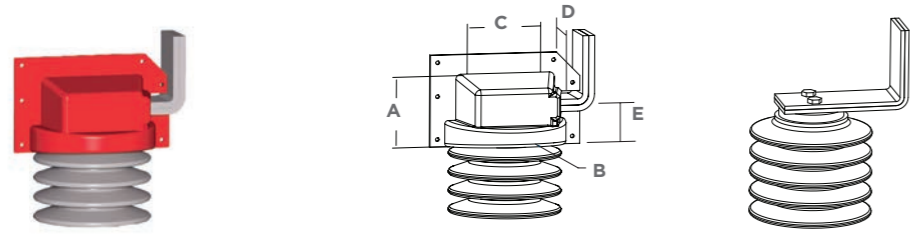

Catalog Number	Height (A)	Base Diameter (B)	Other Measurements (C)	Additional Notes
BCIC-8D/6-3 (B3)	4.7 (119.4)	8.0 (203.2)	5.00 (127) wide	(D) 5.40 (137.2) long, opening (E) 2.75 (69.9) from bottom

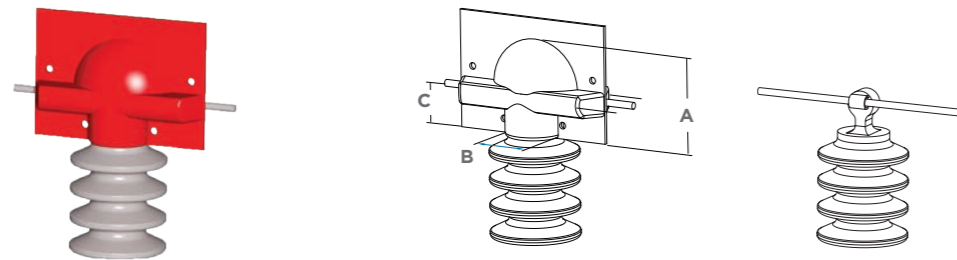

Catalog Number	Height (A)	Base Diameter (B)	Other Measurements (C)	Additional Notes
BCIC-3D/6-3 (B3)	3.5 (90.2)	2 (51)	1.5 (38) L. side diam.	2.0 (51) R. side opening 6.0 (152) width

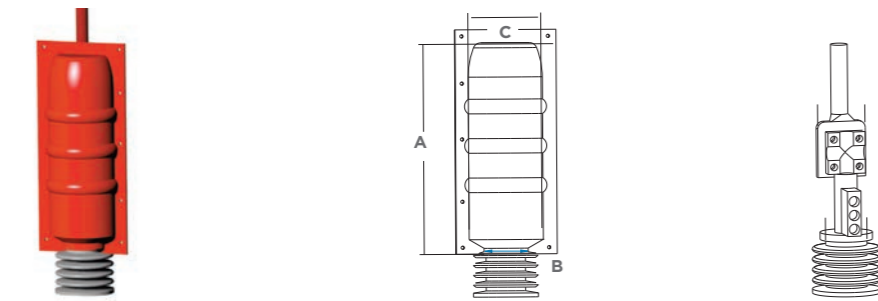

Catalog Number	Height (A)	Base Diameter (B)	Other Measurements (C)	Additional Notes
BCIC-5.5D/16-H0 (B3)	17.1 (434)	3.2 (81)	5.5 (140) top diam.	

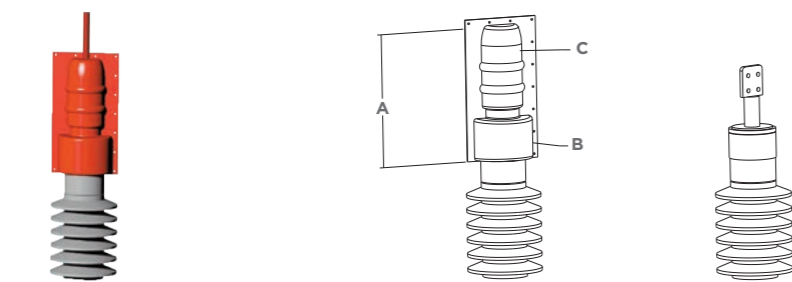

Catalog Number	Height (A)	Base Diameter (B)	Other Measurements (C)	Additional Notes
BCIC-8D/15-H0 (B3)	16.2 (411)	8.0 (203.2)	5.5 (140) top diam.	4.5 (114) middle section diam., 12.5 height of section C.
BCIC-8D/18-H0 (B3)	19.2 (488)	8.0 (203.2)	5.5 (140) top diam.	4.5 (114) middle section diam., 12.5 height of section C.

PRODUCT SELECTION INFORMATION: DIMENSIONS IN INCHES (MM)

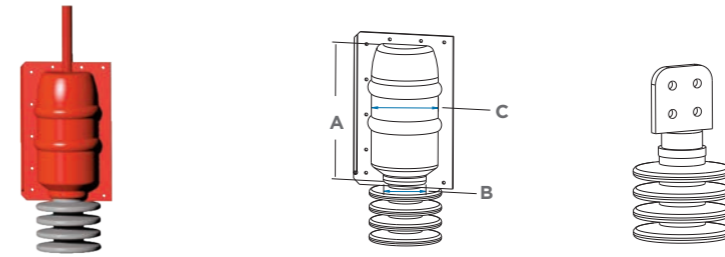

Catalog Number	Height (A)	Base Diameter (B)	Other Measurements (C)	Additional Notes
BCIC-5.5D/11-H0 (B3)	11.5 (292)	3.50 (89)	5.50 (140) mid diam.	N/A

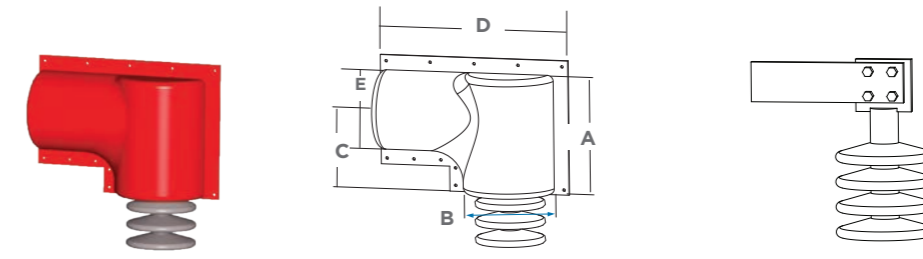

Catalog Number	Height (A)	Base Diameter (B)	Other Measurements (C)	Additional Notes
BCIC-10D/18-3 (B3)	14 (140)	9 (90)	7.75 (77.5)	(D)- 17.00 (E)- 8

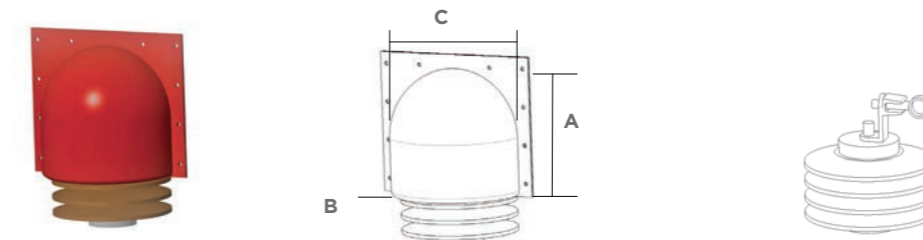

Catalog Number	Height (A)	Base Diameter (B)	Other Measurements (C)	Additional Notes
BCIC-8.25D/8	8 (80)	3 (30)	8.5 (85)	

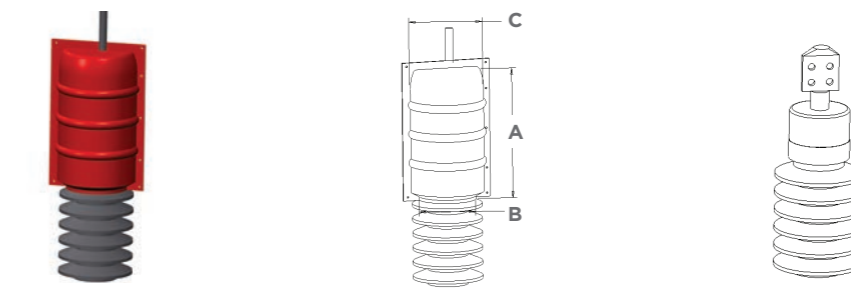

Catalog Number	Height (A)	Base Diameter (B)	Other Measurements (C)	Additional Notes
BCIC-10D/18 (B3)	18 (457.2)	10 (254)	7.7 (195.58)	Bottom Port opening

PRODUCT SELECTION INFORMATION: DIMENSIONS IN INCHES (MM)

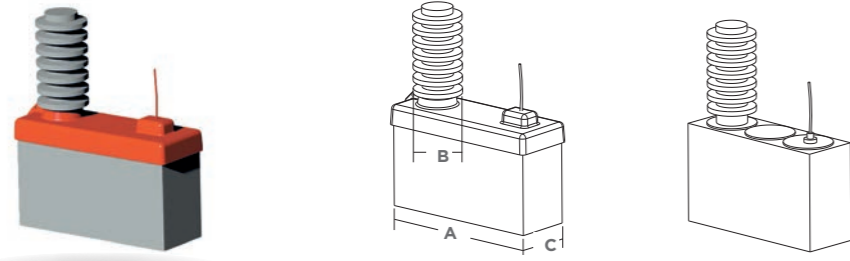

Catalog Number	Height (A)	Base Diameter (B)	Other Measurements (C)	Additional Notes
BCIC-0270-SCE (B3)	13.5 (135)	4.625 (117)	4.625 (46.25)	13.3 (338) length

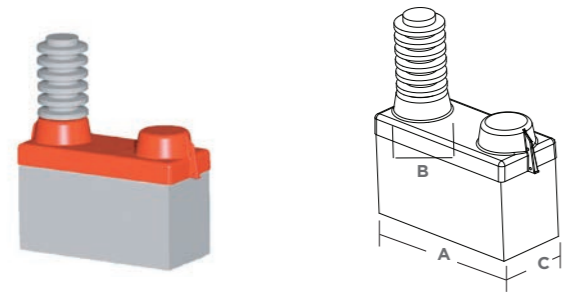

Catalog Number	Height (A)	Base Diameter (B)	Other Measurements (C)	Additional Notes
BCIC-0370-SCE (B3)	13.5 (mm)	3.63 (92)	5.875 (mm)	N/A

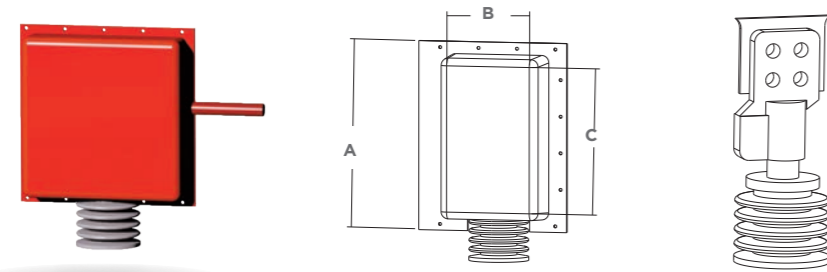

Catalog Number	Height (A)	Base Diameter (B)	Other Measurements (C)	Additional Notes
BCIC-12/12/5-H (B3)	12 (305)	12 (305)	5 (127)	N/A
BCIC-14/19/6-U (B3)	14 (356)	19 (483)	6 (142)	N/A
BCIC-24/11/12 (B3)	11 (279)	24 (610)	12 (304)	N/A
BCIC-4/12/4-H (B3)	4 (102)	12 (305)	4 (102)	N/A
BCIC-7/12/7-H (B3)	7 (178)	12 (305)	7 (178)	N/A
BCIC-4/16/4-H (B3)	4 (102)	16 (406)	4 (102)	N/A

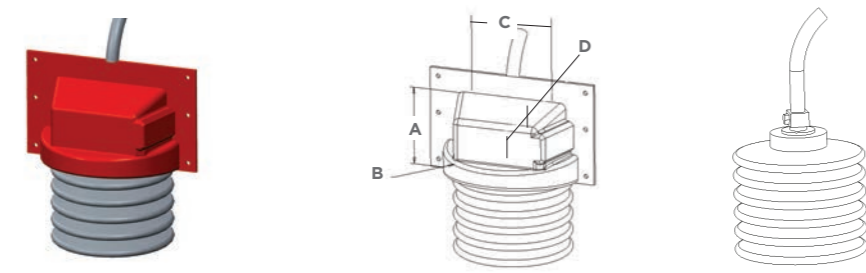

Catalog Number	Height (A)	Base Diameter (B)	Other Measurements (C)	Additional Notes
BCIC-8D/6 (B3)	4.8 (121.92)	8 (203.2)	6.5 (165.1) wide	(D)- 5.00 Supplied in two halves with no pre cut openings

PRODUCT SELECTION INFORMATION: DIMENSIONS IN INCHES (MM)

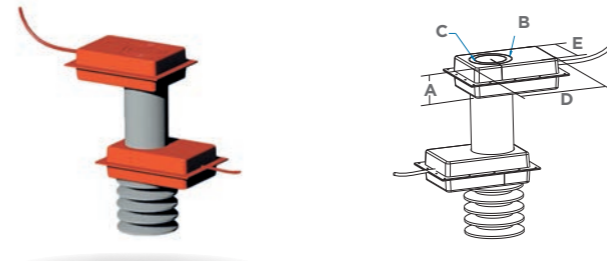

Catalog Number	Height (A)	Base Diameter (B)	Other Measurements (C)	Additional Notes
BCIC-8/12/2-U(B3)	4 (101)	5.75 (146.1)	4.25 (108) inner diam.	(D)- 12.0 (305) wide (E)- 8.0 (203) long

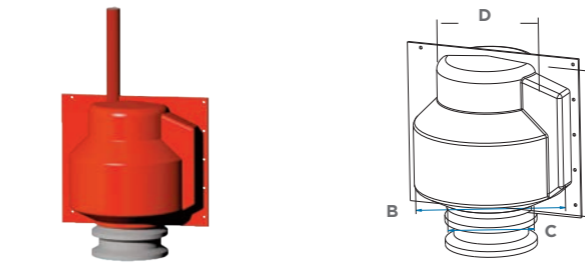

Catalog Number	Height (A)	Base Diameter (B)	Other Measurements (C)	Additional Notes
BCIC-13D/13-H0 (B3)	13 (330)	13 (330)	7.5 (191) inner diam.	(D)- 8.8 (224) top diam.

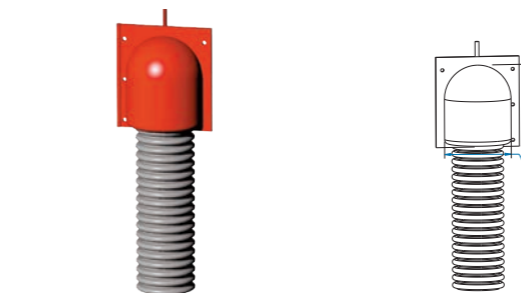

Catalog Number	Height (A)	Base Diameter (B)	Other Measurements (C)	Additional Notes
BCIC-5D/6 (B3)	6 (152)	5 (127)	N/A	N/A

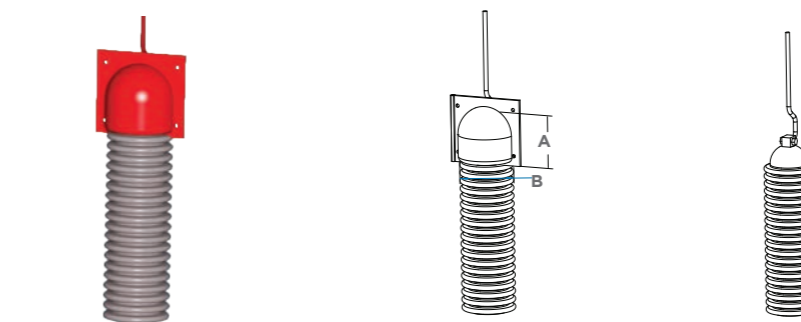

Catalog Number	Height (A)	Base Diameter (B)	Other Measurements (C)	Additional Notes
BCIC-4D/4 (B3)	4 (102)	4 (102)	N/A	N/A

PRODUCT SELECTION INFORMATION: DIMENSIONS IN INCHES (MM)

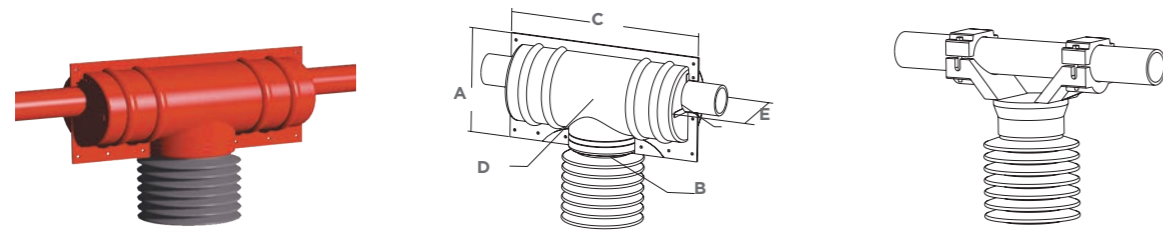

Catalog Number	Height (A)	Base Diameter (B)	Other Measurements (C)	Additional Notes
BCIC-7.5D/18-3 (B3)	10.4 (264)	4.5-6.75 (114-171)	20 (508) length	(D) 7.5 (191) L diam., (E) 2-4 (50-100) R diam.

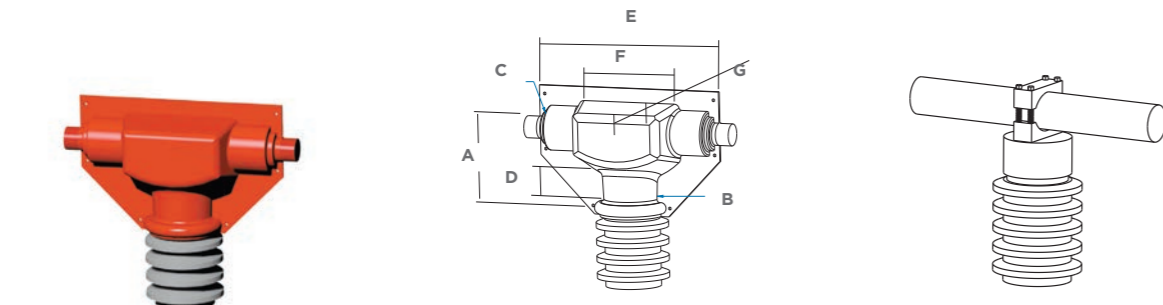

Catalog Number	Height (A)	Base Diameter (B)	Other Measurements (C)	Additional Notes
BCIC-SG-201-SCE(B3)	8.05 (204.5)	5.25 (133.4)	4.0 (102) Max side diam.	(D) 3.0 (76) base-joint height, (E) 17.5 (445) width (F) 8.25 (209.6) (G) 7.25 (184.2) depth

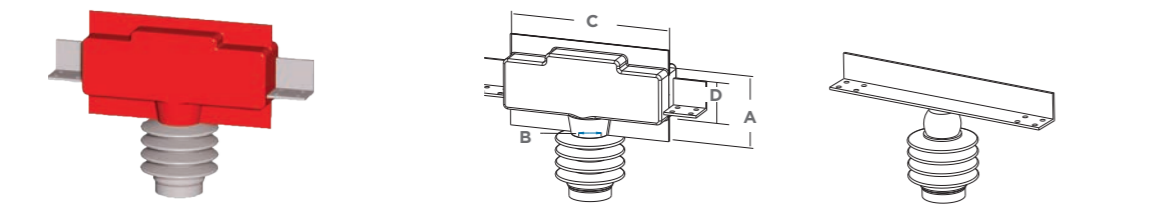

Catalog Number	Height (A)	Base Diameter (B)	Other Measurements (C)	Additional Notes
BCIC-TR205-L (B3)	7.5 (191)	2.25 (57)	17.0 (432) length	(D) 4.25 (108) side height

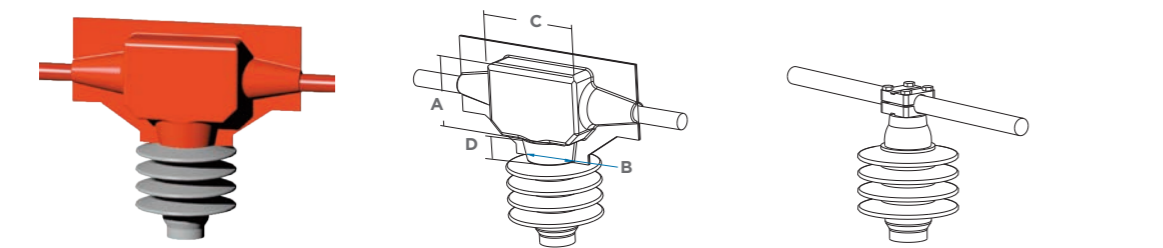

Catalog Number	Height (A)	Base Diameter (B)	Other Measurements (C)	Additional Notes
BCIC-TR205-R (B3)	5.5 (140)	4.5 (114)	8.0 (203)	(D) 2 (50) joint height

PRODUCT SELECTION INFORMATION: DIMENSIONS IN INCHES (MM)

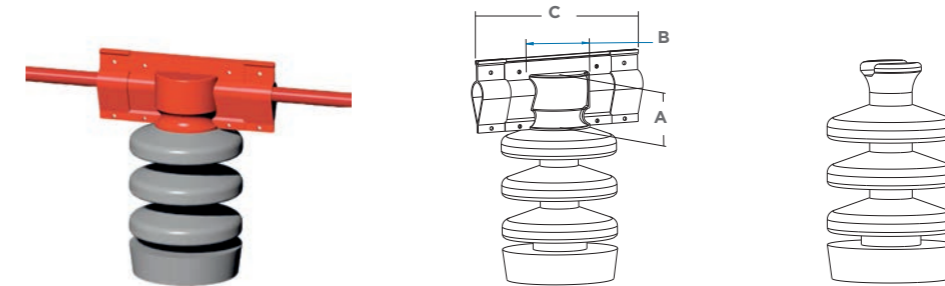

Catalog Number	Height (A)	Base Diameter (B)	Other Measurements (C)	Additional Notes
BCIC-3212-01 (B3)	3.5 (89)	4.125 (105)	12 (305) long	N/A

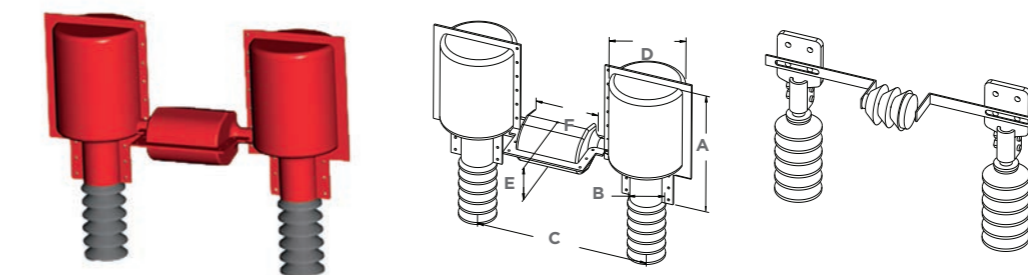

Catalog Number	Height (A)	Base Diameter (B)	Other Measurements (C)	Additional Notes
BCIC-BYPASS (B1)	13.75 (349.25)	3.75 (95.25)	19.00 (483) max distance	8.00 (203) top diam.,(D) 4.00 (102) connector diam., (E) 7.00 (178) (F) Design has two columns Connected with a cylinder



Catalog Number	Height (A)	Base Diameter (B)	Other Measurements (C)	Additional Notes
BCIC-LATCH (B250)	.800 (20.32)	.700 (17.78)	N/A	Std. Pack: 250 Latches or 1000 Latches

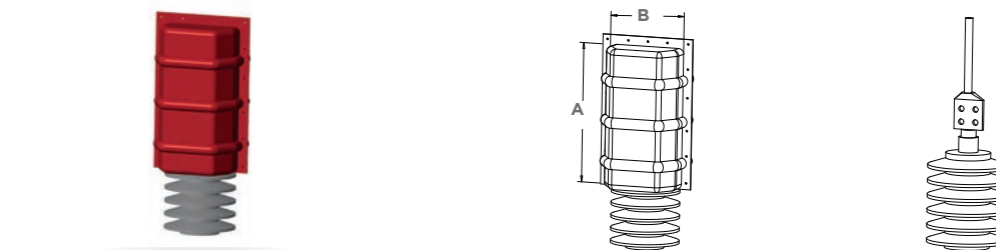

Catalog Number	Height (A)	Base Diameter (B)	Other Measurements (C)	Additional Notes
BCIC-11.5D/22(B3)	22 (559)	11.5 (292)	N/A	No pre trimmed openings

PRODUCT SELECTION INFORMATION: DIMENSIONS IN INCHES (MM)

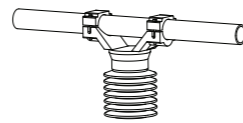
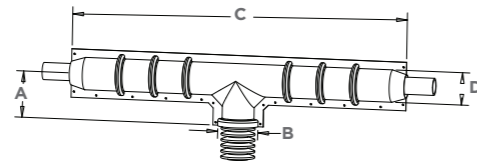

Catalog Number	Height (A)	Base Diameter (B)	Other Measurements (C)	Additional Notes
BCIC-5.5D/50	8 (200)	7 (178)	60 long (1524)	D- fits up to a 5.5" dia. bus

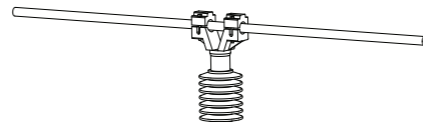
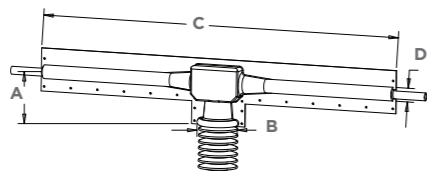

Catalog Number	Height (A)	Base Diameter (B)	Other Measurements (C)	Additional Notes
BCIC-5.5D/60(B3)	10.5 (267)	6.5 (165)	60 long (1524)	D- fits up to a 2" dia. bus

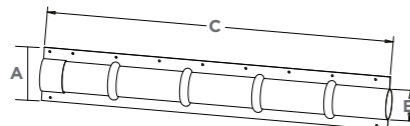

Catalog Number	Height (A)	Base Diameter (B)	Other Measurements (C)	Additional Notes
BCIC-G-4D/48-01(B4)	7.25 (184)	4 (101)	48 long (1219)	N/A

BCIC Reclosers Covers

FEATURES

- One piece hinged design allows easy and quick installations
- Cover can be re-entered for maintenance needs and then reused
- Rated for up to 35kV

APPLICATIONS

- Reclosers

BENEFITS

- Other TE Raychem products can be purchased that insulate the leads and lightning arresters
- Years of reliable service and re-usable design lowers overall lifetime costs

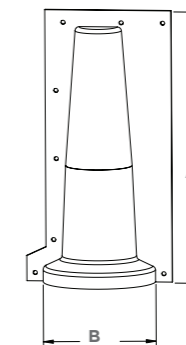

BCIC-G-Recloser-100 (B6)

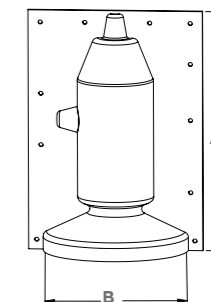

BCIC-G-Recloser-200 (B6)

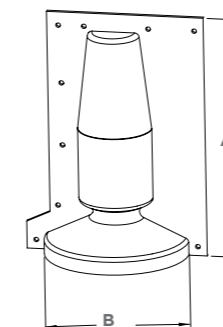

BCIC-G-Reclosercover (B6)

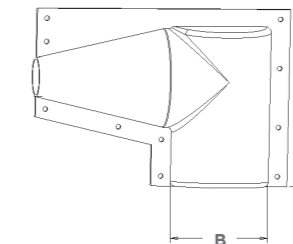

BCIC-5D/8/11 (B6)

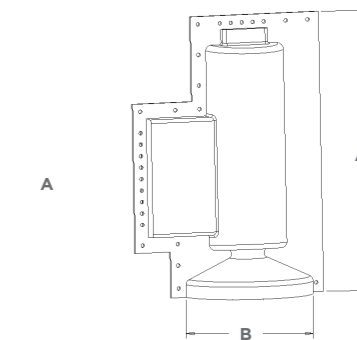

BCIC-Reclosure-200s (B6)

PRODUCT SELECTION INFORMATION: DIMENSIONS IN INCHES (MM)

Catalog Number	Color	Height (A)	Max Skirt (B)
BCIC-G-Reclosercover (B6)	Gray	12.4 (315)	7.8 (198)
BCIC-G-Recloser-100 (B30)	Gray	15.4 (390)	6.75 (171)
BCIC-G-Recloser-200 (B6)	Gray	14.5 (368)	8.5 (216)
BCIC-Reclosercover (B6)	Red	12.4 (315)	7.8 (198)
BCIC-Recloser-100 (B6)	Red	15.4 (390)	6.75 (171)
BCIC-Recloser-200S (B6)	Red	18.3 (465)	8.3 (211)
BCIC-G-Recloser-200S (B6)	Gray	18.3 (465)	8.3 (211)
BCIC-5D/8/11 (B6)	Red	9.0 (228)	4.8 (122)

BCIC-115-PH Transmission Flashover Protection Covers

FEATURES

- TE's Raychem BCIC-115-PH can be used on both porcelain disc and polymeric insulator designs
- Unique design allows the cover to rest on the lowest insulator for porcelain i-string designs
- Made from robust BCIS high-voltage material that is rugged, non-tracking, and UV-Resistant polymer

APPLICATIONS

- 115 kV transmission lines

BENEFITS

- Long-term performance even in the most extreme environmental conditions
- Can be used on energized or de-energized installations

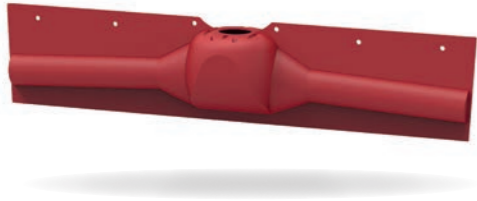

PRODUCT SELECTION INFORMATION: DIMENSIONS IN INCHES (MM)

Catalog Number	Length	Height	Insulator Range	Applications
BCIC-115-PH (B1)	74 (1879.6)	15 (381)	9 12 (229-305)	Main cover
BCIC-Collar-50/280-5-B	-	-	-	Adapter collar for polymeric installations

BCIC-AFD-01 Avian Flight Diverters

FEATURES

- TE's Raychem BCIC-AFD-01 is designed to prevent bird collisions with power lines
- Incorporates high reflectivity and "glow-in-the dark" appliques
- Easy to install, Hot-stickable, removeable
- Made from robust BCIC polymer that is rugged, non-tracking and UV resistant

APPLICATIONS

- Distribution and transmission lines

BENEFITS

- Long-term performance even in the most extreme environmental conditions
- Can be used on energized or de-energized installations



PRODUCT SELECTION INFORMATION: DIMENSIONS IN INCHES (MM)

Catalog Number	Description	Dimensions W x H	Conductor Size	Standard Pack
CU7208-000	BCIC-AFD-01 (B10)	4 x 3.5 (102 - 89)	#6-795	10

ADDITIONAL PRODUCT INFORMATION

- EDR-5536, Rev. A

BCIC Birdcap Protection Covers



The Birdcap family of insulating covers are specifically designed to protect birds from causing flashovers during take-off, landing and perching on energised conductors at crossarm and poletop insulators. This also protects the network from outages and potential damage to equipment and conductors.

Birdcaps are available in three materials, from a high performance, UV stable, track resistant Raychem material to a fit for function M.V. and Low Pollution environment material to a UV stable grade clear material for enhanced clarity during aerial visual inspection in remote locations.

A variety of different shapes and sizes are available to cover different support insulator/insulator interfaces at transmission and distribution voltage classes.

Installation can be made quickly in the field by Cable-Ties, Latches, Screws or Hotsticking on live conductors.

FEATURES

- Crosslinked
- Excellent TERT
- Good Dielectric Strength
- UV Stable
- Flexible

MATERIAL OPTIONS

- Raychem Red: UV stable, track, chemical and pollution resistant. Crosslinked for high thermal stability. Flexible for curved installation at double insulator pole arrangements

BENEFITS

- 25 years lifetime in harsh
- Environment of high pollution, high
- Sun exposure and low rain fall

TEST REPORT

EDR-5385



BCIC-1217-TR: Post Insulator application



BCIC-TEN-01: Tension Insulator application

PRODUCT SELECTION INFORMATION: DIMENSIONS IN INCHES (MM)

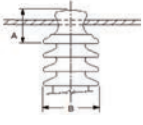
Insulator Size (mm)	BCIC-xxxx Family Part Descriptions									
	1215	1216	1217	1218	1219	1215-005	1215-006	3313	3314	
	A min = 40 A max = 150	A min = 40 A max = 150	A min = 40 A max = 150	A min = 40 A max = 150	A min = 40 A max = 150	A min = 90 A max = 130	A min = 90 A max = 130	A min = 60 A max = 120	A min = 60 A max = 120	
	B min = 90 B max = 190	B min = 90 B max = 190	B min = 90 B max = 190	B min = 90 B max = 190	B min = 90 B max = 190	B min = 90 B max = 185	B min = 90 B max = 185	B min = 130 B max = 160	B min = 130 B max = 160	
Conductor Size (mm ²)	70 - 120	25 - 120	25 - 150	70 - 120	25 - 150	70 - 120	70 - 120	25 - 300	25 - 300	
Length (mm)	1,400	1,400	1,400	1,400	1,400	1020	1150	1,380	1,380	
Live Installation	Yes	No	Yes	Yes	No	Yes	Yes	No	No	
Pack Sizes	3 or 36	3 or 36	3 or 36	36	3 or 36	50	10	3 or 24	3 or 24	

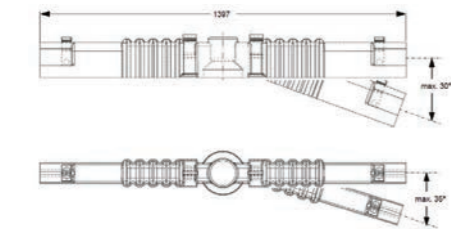

BCIC-1215/16/17/18/19

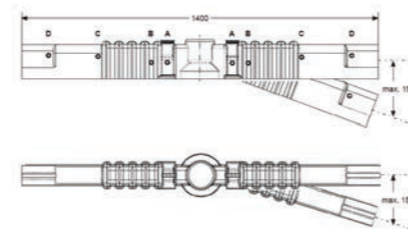

BCIC-1217-TR

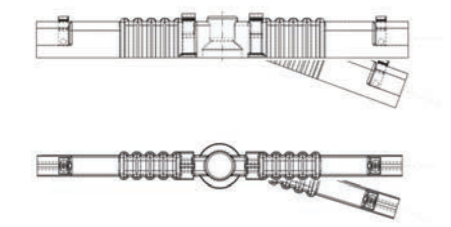

BCIC-1215-005/006

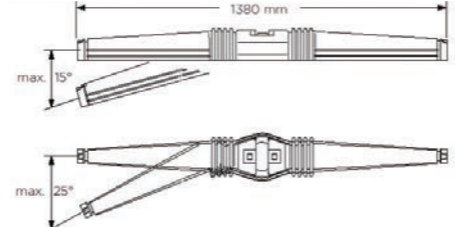

BCIC-3313/14

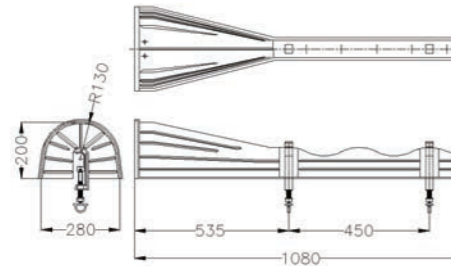

BCIC-TEN-01

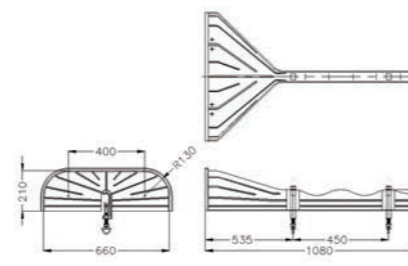

BCIC-TEN-03

For further assistance contact your local TE representative

BISG / BISG-24 Bus Isolation Squirrel Guards

FEATURES

- High voltage outdoor materials are used in the design
- Polymer is rugged, track resistant, UV-Stable, and ensures long-term performance regardless of environmental conditions
- Comes in red or gray colors
- Sizes range from two to five inches from the factory with "grill" design allowing for easy field modifications

APPLICATIONS

- TE's Raychem BISG is on installed substation equipment to protect animal caused outages

BENEFITS

- The Isolation guard has reliably prevented animal-caused outages in electrical substation equipment for years
- Allow excellent visibility of switch blades and other components while providing resistance to power arcs and high winds
- Designed to allow one person to quickly and easily install with hot-sticks on vertical or horizontal mounted insulators

PRODUCT SELECTION INFORMATION: DIMENSIONS IN INCHES (MM)

Catalog Number	Insulator Core Diameter Range	Overall Product Diameter	Color	Installation
BISG-60/115-02(S10)	2.4-4.5 (60-115)	24	Red	De-energized
BISG-60/115-03-HOT (B10)	2.4-4.5 (60-115)	24	Red	Two stick (energized)
BISG-G-60/115-02(S10)	2.4-4.5 (60-115)	24	Gray	De-energized
BISG-G-60/115-03-HOT-B10	2.4-4.5 (60-115)	24	Gray	Two stick (energized)
BISG-24-01 (B10)	2.5-5.0 (62-125)	24	Red	One stick (energized)
BISG-G-24-01 (B10)	2.5-5.0 (62-125)	24	Gray	One stick (energized)
BISG-100/400 (B3)	1.50-4.50 (38-115)	16	Red	De-energized
BISG-G-100/400 (B3)	1.50-4.50 (38-115)	16	Gray	De-energized



BISG-60/115-02



BISG-24



BISG-100/400

ADDITIONAL PRODUCT INFORMATION

- Standard package: 10 BISG-60/115-02 | 10 BISG-24-01 assemblies per box. (One BISG will install on one insulator)
- Related test report: EDR-5310, EDR-5517-Bus Insulator Squirrel Guard (BISG-24-01)

MVFT Medium Voltage Fusion Tape

FEATURES

- Self amalgamating
- Designed to combine the integrity of silicone polymer with the versatility of a wraparound product
- MVFT will stick to itself and other insulating materials, but will not adhere to metal or porcelain

APPLICATIONS

- TE's Raychem MVFT retrofit insulation of busbars
- Insulation when existing equipment can not be dismantled
- Suitable for indoor and outdoor use

BENEFITS

- Quick and easy to install
- Over-lapped layers amalgamate together, producing a complete seal
- A single layer of MVFT tape, two-thirds overlapped, will provide flashover protection to at least 15 kV and increases to 35 kV if second layer is added
- Selective sticking allows for easy removal for maintenance

PRODUCT SELECTION INFORMATION

Catalog Number	Color	Width UOM: Inches (mm)	Length per Roll (m)	Installation
MVFT-G-2-12 (B4)	Gray	2 (50)	36 (11)	4 rolls

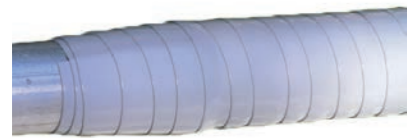

RECTANGULAR BUSBAR



Bus Width inches (mm)	Bus Length Insulated per Roll 2/3 Overlap feet (m)
1.0 (25)	8 (2.4)
2.0 (50)	4.7 (1.4)
3.0 (75)	3.1 (0.9)
4.0 (100)	2.3 (0.7)
6.0 (150)	1.4 (0.4)
8.0 (200)	0.4 (0.1)

ROUND BUSBAR



Bus Width inches (mm)	Bus Length Insulated per Roll 2/3 Overlap feet (m)
0.5 (12)	12.9 (3.9)
1.0 (25)	7.2 (2.2)
2.0 (50)	3.6 (1.1)
3.0 (75)	2.2 (0.7)
4.0 (100)	2.0 (0.6)

SQUARE BUSBAR



Bus Width inches (mm)	Bus Length Insulated per Roll 2/3 Overlap feet (m)
1x1 (25)	5.7 (1.7)
2x2 (50)	2.8 (0.8)
3x3 (75)	1.9 (0.6)
4x4 (100)	1.7 (0.5)

ADDITIONAL PRODUCT INFORMATION

- EDR-5465 Medium Voltage Fusion Tape Qualification Report

LVIT Busbar Insulating Tubing (1000 V)

FEATURES

- Rated to ANSI/IEEE C37.20.1. UL recognized to Standard 224 (file E137416), 600 V-125°C-VW.1

APPLICATIONS

- When used according to the selection guidelines, TE's Raychem LVIT may be used in applications up to 1 kV in accordance with ANSI/IEEE C37.20 specification. LVIT tubing may be used in applications up to 3.6 kV in accordance with IEC specifications

BENEFITS

- TE's Raychem LVIT is a heat-shrinkable medium-wall, flame-retardant, low voltage tubing for insulating straight and bent busbars during original equipment assembly or in retrofit applications where access to one end of the busbar is available



PRODUCT SELECTION INFORMATION: DIMENSIONS IN INCHES (MM)

Catalog Number	Rectangular Bar* (Bus Width)	Square Bar (Each Side)	Round Bar (Dia min - max)	LVIT Tubing Dia as Supplied & Fully Recovered (min - max)	Standard Pack
LVIT-30/10-A/U	0.50-1.0 (12-25)	-	0.40-1.0 (11-25)	1.18-0.39 (30-10)	200 ft.
LVIT-75/25-A/U	2.0-3.0 (50-75)	1 (25)	1.0-2.0 (25-50)	2.95-0.98 (75-25)	100 ft.
LVIT-150/50-A/U	4.0-6.0 (100-150)	2-3 (50-75)	2.0-4.0 (50-100)	5.91-1.97 (150-50)	100 ft.

* Rectangular bus thickness range is 1/4 to 5/8 inch. Test Reports: EDR-5483, EDR-5499

HVBS High Voltage Booster Sheds

FEATURES

- Spacers and short pegs which separate it from the porcelain skirt and insulator core
- TE's Raychem HVBS booster shed is a wrap around for rapid installation

APPLICATIONS

- Circuit breaker bushings
- Bus support insulators
- Surge arresters
- Transformer bushings

BENEFITS

- Prevents "Heavy Wetting" and ice-cascade-induced flashovers
- Made with advanced UV-resistant and anti-tracking polymer



PRODUCT SELECTION INFORMATION: DIMENSIONS IN INCHES (MM)

Catalog Number	Suitable Insulator Core	Medium Outside Insulator Skirt	Booster Shed Diameter Fully Installed
HVBS-770/310-01-M-BP	8.9-10.1 (227-257)	12.0 (304)	28.1 (713)
HVBS-740/280-01-M-BP	7.8-9.0 (199-229)	10.9 (276)	27.0 (685)
HVBS-710/250-01-M-BP	6.9-7.9 (175-201)	9.8 (249)	25.9 (657)
HVBS-685/225-01-M-BP	6.2-7.0 (158-178)	9.3 (235)	25.0 (634)
HVBS-665/205-01-M-BP	5.5-6.3 (140-160)	8.5 (216)	24.3 (616)
HVBS-615/155-01-M-BP	3.7-4.5 (94-114)	6.3 (161)	22.4 (569)

ADDITIONAL PRODUCT INFORMATION

- Related Test Report: UVR-8107 Qualification report for Booster Sheds
- Please contact your TE sales team for other available sizes.

RRGS Polymeric and Porcelain Rigid Red Guano Shields

FEATURES

- TE's Raychem RRGs is designed to fit both porcelain bells and polymeric insulators
- Two piece design allows for quick installation

APPLICATIONS

- Vertical insulator strings

BENEFITS

- Protects insulators from bird streamers



PRODUCT SELECTION INFORMATION: DIMENSIONS IN INCHES

Catalog Number	Insulator Type	Shield Diameter
RRGS-35/470-FT (B12)	Polymeric	18
RRGS-35/600-FT (B3)	Polymeric	24
RRGS-35/470-M (B12)	Porcelain	18
RRGS-35/600-M (B12)	Porcelain	24

Gray color also available

LVBT Low Voltage Busbar Insulating Heat Shrink Tape

FEATURES

- Rated to ANSI/IEEE C37.20

APPLICATIONS

- TE's Raychem LVBT is an adhesive-coated, low-voltage heat-shrinkable tape. One wrap insulates straight and bent bars in retrofit applications where tubing cannot be used. In addition, LVBT easily insulates unusual connections and geometries in the factory or field

BENEFITS

- Adhesive layer fuses the tape layers but does not stick to bus or hardware, providing tough insulation up to 1 kV in accordance with ANSI C37.20 and up to 3.6 kV in accordance with IEC specifications



LVBT TAPE DIMENSIONS

Catalog Number	Roll width in (mm)	Roll Length Ft. (m)
LVBT-1-R	1 (25)	25 (7.5)
LVBT-2-R	2 (50)	25 (7.5)
LVBT-4-R	4 (100)	25 (7.5)

PRODUCT SELECTION INFORMATION: DIMENSIONS IN FEET(M)

Bus Width	Catalog Number	Bus Length Insulated per Roll	Rolls/Standard Pack
1 (25)	LVBT-1-R	3.8 (1.2)	8
2 (50)	LVBT-2-R	4.8 (1.5)	4
3 (75)	LVBT-2-R	3.5 (1.1)	4
4 (100)	LVBT-2-R	2.7 (0.8)	4
6 (150)	LVBT-2-R	1.9 (0.6)	4
8 (200)	LVBT-4-R	2.9 (0.9)	4

RECTANGULAR BUSBAR*

1 (25)	LVBT-1-R	3.8 (1.2)	8
2 (50)	LVBT-2-R	4.8 (1.5)	4
3 (75)	LVBT-2-R	3.5 (1.1)	4
4 (100)	LVBT-2-R	2.7 (0.8)	4
6 (150)	LVBT-2-R	1.9 (0.6)	4
8 (200)	LVBT-4-R	2.9 (0.9)	4

* Maximum thickness: 5/8 (15)

SQUARE BUSBAR

1 (25)	LVBT-2-R	6.25 (2.0)	4
2 (50)	LVBT-2-R	3.1 (1.0)	4
3 (75)	LVBT-2-R	2.0 (0.6)	4
4 (100)	LVBT-4-R	3.1 (1.0)	2
6 (150)	LVBT-4-R	2.0 (0.6)	2

ROUND BUSBAR

0.5 (12)	LVBT-1-R	8.0 (2.6)	8
1.0 (25)	LVBT-2-R	8.0 (2.6)	4
2.0 (50)	LVBT-2-R	4.0 (1.3)	4
3.0 (75)	LVBT-2-R	2.6 (0.9)	4
4.0 (100)	LVBT-4-R	4.0 (1.3)	2

ADDITIONAL PRODUCT INFORMATION

- LVBT-1-R is best for shorter lengths. LVBT-2-R is the most versatile width for general purpose use. LVBT-4-R is useful for long lengths and larger bus sizes.
- If sealing is needed, order the S1052-6-150 sealant strips.
- Related Test Reports: EDR-5490 and EDR-5499



Chapter VI Insulators

RLP F-Neck EVA Line Post Insulators	159
RLP Vertical Clamp EVA Line Post Insulators	160
RLP Horizontal Clamp EVA Line Post Insulators	161
CLP Silicone Line Post Insulators.....	162
RST, EVA Suspension Tension Insulators	164
CS Silicone Suspension Tension Insulators	165
EPBI, EVA Standoff Insulators.....	167
RAP, EVA Polymeric Station Post Insulators	168
HSHI-RAYBOWL Hybrid Line Post Insulators	169
Porcelain Disc Insulators	170
Porcelain Station Post Insulators	173

Overview of our Insulators Range

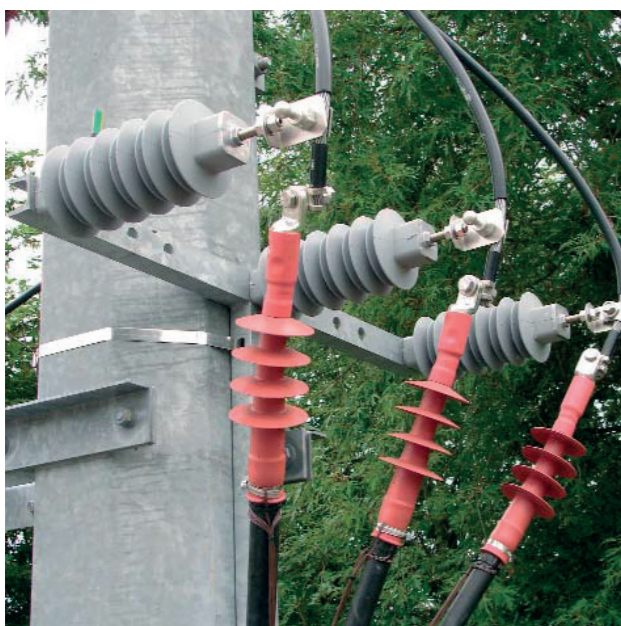

Our wide range of insulators has earned a worldwide reputation for innovation, quality, service and technical expertise for an array of applications in power networks.

- Porcelain Insulators
- Polymeric Insulators
- Hybrid Insulators

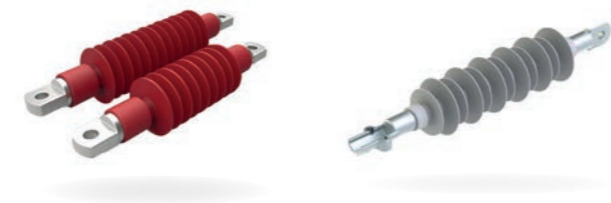
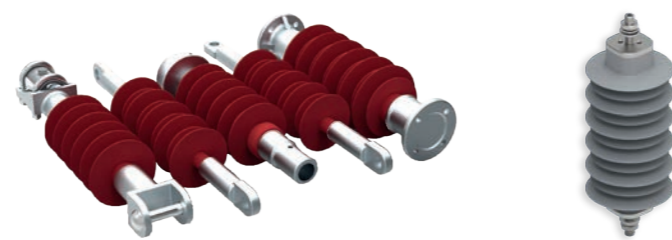

RLP F-Neck EVA Line Post Insulators



GENERAL DESCRIPTION

The TE's Raychem polymeric line post insulator RLP combines mechanical strength with excellent pollution performance.

It consists of a pultruded fibre glass rod and a non tracking polymer housing which is directly bonded to the metal end fitting. Corrosion resistant end fittings are crimped to the pultruded fibreglass core to allow the transition of mechanical loading to the line and mounting structure.

A patented crimp control technology monitors for damage to the fibreglass rod while achieving maximum mechanical strength.

SELECTION INFORMATION: DIMENSIONS SHOWN IN MILLIMETERS

Description	Std Pkg	Pkg Weight	Pkg Volume
RLP-19R-FG-M24NPG-M	45 pcs	177 Kg	0.504 m ³
RLP-30R-FG-M24NPG-M	45 pcs	190 Kg	0.504 m ³
RLP-31R-FG-M24NPG-M	45 pcs	249 Kg	0.504 m ³
RLP-36R-FG-M24NPG-M	45 pcs	258 Kg	0.504 m ³
RLP-43R-FG-M24NPG-M	45 pcs	267 Kg	0.504 m ³

Technical Specification	RLP-19R-FG	RLP-30R-FG	RLP-31R-FG	RLP-36R-FG	RLP-43R-FG
Creepage Distance (mm)	424	697	770	922	1074
Dry Arc Distance (mm)	169	235	260	300	340
No of Sheds	4	7	9	11	13
A (mm)	285	351	375	415	455
B (mm)	100	100	92	92	92
C (mm)	120	120	122	122	122
SCL (kN)	12.5	11.5	12.5	12.5	12.5
MDCL (kN)	5.5	5.5	5.5	5.5	5.5
STL (kN)	25	25	25	25	25
RTL (kN)	12.5	12.5	12.5	12.5	12.5
AC dry flashover voltage (kV)	104	137	150	163	176
AC dry withstand voltage (kV)	95	124	136	146	159
AC wet flashover voltage (kV)	72	91	101	120	129
AC wet withstand voltage (kV)	61	76	81	103	112
Impulse withstand voltage (kV)	137	183	194	219	244

NOTE Full qualification according to IEC 61952, and additional environmental testing available on request.

Product	Test Report
RLP-19R-FG-3/4NPG-M	IPMR_077
RLP-30R-FG-3/4NPG-M	IPMR_078
RLP-31R-FG-3/4NPG-M	IPMR_079
RLP-36R-FG-3/4NPG-M	IPMR_080
RLP-43R-FG-3/4NPG-M	IPMR_081

RLP Vertical Clamp EVA Line Post Insulators



GENERAL DESCRIPTION

The TE's Raychem polymeric line post insulator RLP combines mechanical strength with excellent pollution performance.

It consists of a pultruded fibre glass rod and a non tracking polymer housing which is directly bonded to the metal end fitting. Corrosion resistant end fittings are crimped to the pultruded fibreglass core to allow the transition of mechanical loading to the line and mounting structure.

A patented crimp control technology monitors for damage to the fibreglass rod while achieving maximum mechanical strength.

SELECTION INFORMATION: DIMENSIONS SHOWN IN MILLIMETERS

Description	Std Pkg	Pkg Weight	Pkg Volume
RLP-19R-VG-M24NPG-M	45 pcs	177 Kg	0.504 m ³
RLP-30R-VG-M24NPG-M	45 pcs	190 Kg	0.504 m ³
RLP-31R-VG-M24NPG-M	45 pcs	249 Kg	0.504 m ³
RLP-36R-VG-M24NPG-M	45 pcs	258 Kg	0.504 m ³
RLP-43R-VG-M24NPG-M	45 pcs	267 Kg	0.504 m ³

Technical Specification	RLP-19R-VG	RLP-30R-VG	RLP-31R-VG	RLP-36R-VG	RLP-43R-VG
Creepage Distance (mm)	424	697	770	922	1074
Dry Arc Distance (mm)	169	235	260	300	340
No of Sheds	4	7	9	11	13
A (mm)	299	365	389	429	469
B (mm)	100	100	92	92	92
C (mm)	120	120	122	122	122
SCL (kN)	12.5	11.5	12.5	12.5	12.5
MDCL (kN)	5.5	5.5	5.5	5.5	5.5
STL (kN)	25	25	25	25	25
RTL (kN)	12.5	12.5	12.5	12.5	12.5
AC dry flashover voltage (kV)	104	137	150	163	176
AC dry withstand voltage (kV)	95	124	136	146	159
AC wet flashover voltage (kV)	72	91	101	120	129
AC wet withstand voltage (kV)	61	76	81	103	112
Impulse withstand voltage (kV)	137	183	194	219	244

Product	Test Report
RLP-19R-VG-3/4NPG-M	IPMR_077
RLP-30R-VG-3/4NPG-M	IPMR_078
RLP-31R-VG-3/4NPG-M	IPMR_079
RLP-36R-VG-3/4NPG-M	IPMR_080
RLP-43R-VG-3/4NPG-M	IPMR_081

RLP Horizontal Clamp EVA Line Post Insulators



GENERAL DESCRIPTION

The TE's Raychem polymeric line post insulator RLP combines mechanical strength with excellent pollution performance.

It consists of a pultruded fibre glass rod and a non tracking polymer housing which is directly bonded to the metal end fitting. Corrosion resistant end fittings are crimped to the pultruded fibreglass core to allow the transition of mechanical loading to the line and mounting structure.

A patented crimp control technology monitors for damage to the fibreglass rod while achieving maximum mechanical strength.

SELECTION INFORMATION: DIMENSIONS SHOWN IN MILLIMETERS

Description	Std Pkg	Pkg Weight	Pkg Volume
RLP-19R-HG-M24NPG-M	45 pcs	177 Kg	0.504 m ³
RLP-30R-HG-M24NPG-M	45 pcs	190 Kg	0.504 m ³
RLP-31R-HG-M24NPG-M	45 pcs	249 Kg	0.504 m ³
RLP-36R-HG-M24NPG-M	45 pcs	258 Kg	0.504 m ³
RLP-43R-HG-M24NPG-M	45 pcs	267 Kg	0.504 m ³

Technical Specification	RLP-19R-FG	RLP-30R-FG	RLP-31R-FG	RLP-36R-FG	RLP-43R-FG
Creepage Distance (mm)	424	697	770	922	1074
Dry Arc Distance (mm)	169	235	260	300	340
No of Sheds	4	7	9	11	13
A (mm)	320	386	410	450	490
B (mm)	100	100	92	92	92
C (mm)	120	120	122	122	122
SCL (kN)	12.5	11.5	12.5	12.5	12.5
MDCL (kN)	5.5	5.5	5.5	5.5	5.5
STL (kN)	25	25	25	25	25
RTL (kN)	12.5	12.5	12.5	12.5	12.5
AC dry flashover voltage (kV)	104	137	150	163	176
AC dry withstand voltage (kV)	95	124	136	146	159
AC wet flashover voltage (kV)	72	91	101	120	129
AC wet withstand voltage (kV)	61	76	81	103	112
Impulse withstand voltage (kV)	137	183	194	219	244

NOTE Full qualification according to IEC 61952, and additional environmental testing available on request.

Product	Test Report
RLP-19R-HG-3/4NPG-M	IPMR_077
RLP-30R-HG-3/4NPG-M	IPMR_078
RLP-31R-HG-3/4NPG-M	IPMR_079
RLP-36R-HG-3/4NPG-M	IPMR_080
RLP-43R-HG-3/4NPG-M	IPMR_081

CLP Silicone Line Post Insulators



GENERAL DESCRIPTION

The high tensile strength of Fiber Reinforced Plastic (FRP) has been combined with our HV shed profile to produce this rugged, lightweight tension insulator for overhead line applications. The glass fiber core provides high mechanical strength with cantilever loads up to 15 kN. The silicone insulator profile is backed by 40 years of TE's Raychem, Bowthorpe EMP and Axicom medium and high voltage product design.

PART DESCRIPTION KEY

CLP - Composite Line Post **XX** - SCL **XXXX** - Top / Bottom End fig **XXX** - BIL (kV) **XXXX** - Creepage distance (mm) **X** - Mfg. Style **XX** - Special code

FEATURES

- Specified Cantilever Load (SCL) up to 15 kN / 3,372 lbs
- Wide selection of galvanized metal end fittings
- Line post insulators qualified to IEC 61952 or ANSI C29.18
- Quality design and manufactured to ISO 9001

BENEFITS

- Lightweight for easier installation
- Silicone housing has excellent hydrophobic properties
- Shed design to minimize insulator length per kV rating
- Shock and vibration resistant
- Good tracking and erosion resistance performance
- Maintenance free

F-NECK INSULATORS - DIMENSIONS AND ELECTRICAL PROPERTIES

TCPN	Description	Top Fitting	Bottom Fitting	Creepage distance (mm)	Dry arc distance (mm)	No. of Sheds	Average Dry W/S Voltage (kV)	Average wet W/S Voltage (kV)	Imp W/S Voltage +ve (kV)	SCL (kN)	Section Length L (mm)	Approx. Weight (kg)	Std Pack Qty	Pollution Category
EP4105-000	CLP-15-FM20-140-0510-0-02	F- Neck	M20 Stud Fitting	510	210	7	90	60	140	15	253	3.3	3	Very heavy
EP4106-000	CLP-13-FM20-175-0715-0-02	F- Neck	M20 Stud Fitting	715	260	10	100	80	175	13	307	3.6	3	Very heavy
EP4107-000	CLP-12.5-FM20-205-0915-0-02	F- Neck	M20 Stud Fitting	915	315	13	115	95	205	12.5	361	3.9	3	Very heavy
EP4108-000	CLP-11-FM20-225-1120-0-02	F- Neck	M20 Stud Fitting	1120	370	16	125	110	225	11	415	4.1	3	Very heavy
EP4109-000	CLP-15-CM20-140-0510-0-02	C-Neck	M20 Stud Fitting	510	210	7	90	60	140	15	253	3.1	3	Very heavy
EP4110-000	CLP-13-CM20-175-0715-0-02	C-Neck	M20 Stud Fitting	715	260	10	100	80	175	13	307	3.3	3	Very heavy
EP4111-000	CLP-12.5-CM20-205-0915-0-02	C-Neck	M20 Stud Fitting	915	315	13	115	95	205	12.5	361	3.7	3	Very heavy
EP4112-000	CLP-11-CM20-225-1120-0-02	C-Neck	M20 Stud Fitting	1120	370	16	125	110	225	11	415	3.9	3	Very heavy
EP4976-000	CLP-15-FM20-140-370-M	F- Neck	M20 Stud Fitting	370	180	4	75	55	140	15	300	3.1	3	Medium
EP4977-000	CLP-12.5-FM20-155-460-M	F- Neck	M20 Stud Fitting	460	225	5	90	70	155	12.5	343	3.3	3	Medium
EP4978-000	CLP-12.5-FM20-175-560-M	F- Neck	M20 Stud Fitting	560	265	6	95	90	175	12.5	385	3.5	3	Medium
EP4979-000	CLP-11-FM20-200-659-M	F- Neck	M20 Stud Fitting	659	314	7	105	100	200	11	426	3.9	3	Medium
EP4973-000	CLP-13-FM20-125-295-M	F- Neck	M20 Stud Fitting	295	170	3	75	55	125	13	265	2.9	3	Medium
EP4974-000	CLP-11-FM20-155-405-M	F- Neck	M20 Stud Fitting	405	230	4	85	70	155	11	322	3.1	3	Medium
EP4975-000	CLP-09-FM20-190-515-M	F- Neck	M20 Stud Fitting	515	285	5	110	100	190	9	379	3.3	3	Medium

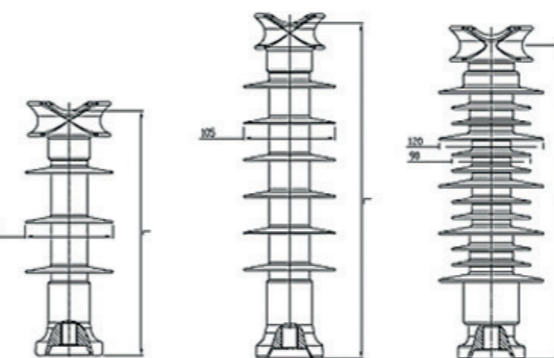

A wide range of end fittings is available. Please contact your TE representative for more details.

Metal End Fitting Selection for Line Post Insulators

Top Fitting

- Neck Tie Top **C**
- Neck Tie Top **F**
- Horizontal Clamp Top **H**
- Vertical Clamp Top **V**
- Bolt Circle -1/2 -13 UNC on 3" **BC**

Bottom Fitting

- Standard Base-Stud with 3/4-10 UNC Threads **S1**
- Bolt Circle -1/2 -13 UNC on 3" **BC**
- Additional thread sizes available upon request

Higher creepage length insulators with alternating housing profile for high pollution environment are also available. Please contact your TE representative for more details.

Line Post Insulators IEC Naming Convention

CLP-XX-XXXX-XXX-XXXX-X-XX

CLP - Composite line post

XX - SCL rating

XXXX - Top/bottom fitting

XXX - BIL (kV)

XXXX - Creepage distance (mm)

X - Manufacturing style

(**M** = Molded in place or **O** = Overmold)

XX - Designation for special items such as fitting type, special packaging, extra galvanizing etc.

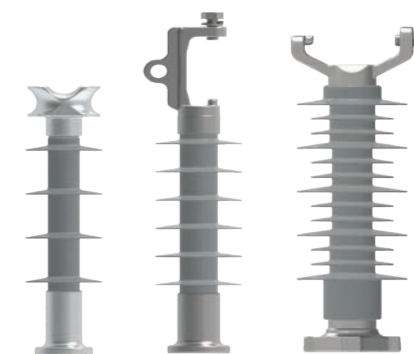

RST, EVA Suspension Tension Insulators



GENERAL DESCRIPTION

The glass fibre core provides high mechanical strength with tensile values of greater than 70 kN. The TE's Raychem insulator profile utilises the same materials technology that has been employed for over 30 years in TE's Raychem's high voltage terminations. Its proven track and erosion resistance and UV stability have given outstanding performance in the widest possible range of climatic and pollution conditions.

The high tensile strength of glass fibre has been combined with our HV shedded profile, to produce this rugged, lightweight tension insulator for overhead line applications up to 69 kV.

SELECTION INFORMATION: DIMENSIONS SHOWN IN MILLIMETERS

	RST-DS15R-CT	RST-DS28R-CT	RST-DS36R-CT	RST-DS46R-CT	RST-DS69R-CT
Dimensions in mm and given in inches in brackets ()					
Length L	318 (12.5)	425 (16.7)	474 (18.7)	613 (24.1)	759 (29.9)
Dry arc	170 (6.7)	290 (11.42)	348 (13.7)	450 (17.7)	610 (24.01)
Creepage	460 (18.1)	690 (27.1)	900 (35.4)	1300 (51.2)	1810 (72.3)
No. of Sheds	5	7	9	13	18
Diameter D1	102(4.01)	97 (3.8)	112 (4.4)	112 (4.4)	112 (4.4)
Diameter D2	83 (3.27)	78 (3.07)	92 (3.6)	92 (3.6)	92 (3.6)
Diameter D3	22 (0.87)	22 (0.87)	28 (1.1)	28 (1.1)	28 (1.1)
Electrical					
Wet AC withstand (kV) (horizontal)	42.1	98	100	130	180
Impulse withstand (kV)	130	226	215	310	350
Mechanical in kN and given in lbs in brackets ()					
Specified Mechanical Load SML	75 (16860)	75 (16860)	75 (16860)	75 (16860)	75 (16860)
Routine test load RTL	37.5 (8430)	37.5 (8430)	37.5 (8430)	37.5 (8430)	37.5 (8430)
Mechanical in kN and given in lbs in brackets ()					
Top:	Clevis end fitting.				
Bottom:	Tongue end fitting.				
Material:	Galvanized Steel				

The clevis fittings include a 16 mm pin. The ball & socket end fittings are as per IEC120-16A. Other end fitting types are available on request.

The descriptions given above describe insulators with clevis and tongue end fittings. Tongue and clevis end fittings can be supplied in any orientation. These products are also available with ball & socket end fittings e.g. RST-DS15R-BS is a 15 kV insulator with ball and socket end fittings. Product range up to and including 69 kV, pollution class II and III according to IEC815.

CS Silicone Suspension Tension Insulators

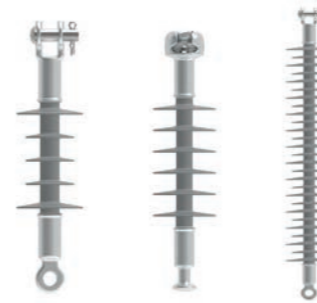

GENERAL DESCRIPTION

The high tensile strength of Fiber Reinforced Plastic (FRP) has been combined with our HV shed profile to produce this rugged, lightweight tension insulator for overhead line applications. The glass fiber core provides high mechanical strength with tensile values of greater than 70 kN/15,000 lbs. The silicone insulator profile is backed by 40 years of TE's Raychem, Bowthorpe EMP and Axicom medium and high voltage product design.

PART DESCRIPTION KEY

CS - Composite Suspension
XX - SML Top/Bottom End Fittings
XXXX - BIL (kV)
XXX - Creepage distance (mm)
X - Mfg. Style
XX - Special code

FEATURES

- 70 kN / 15,000 lbs Tension rating (SML)
- Wide selection of galvanized metal end fittings
- Suspension/tension insulators qualified to IEC 61466-1 or ANSI C29.13
- Quality design and manufactured to ISO 9001

BENEFITS

- Reliable tensile performance
- Lightweight for easier installation
- Silicone housing has excellent hydrophobic properties
- Shed design to minimize insulator length per kV rating
- Shock and vibration resistant
- Good tracking and erosion resistance performance
- Maintenance free

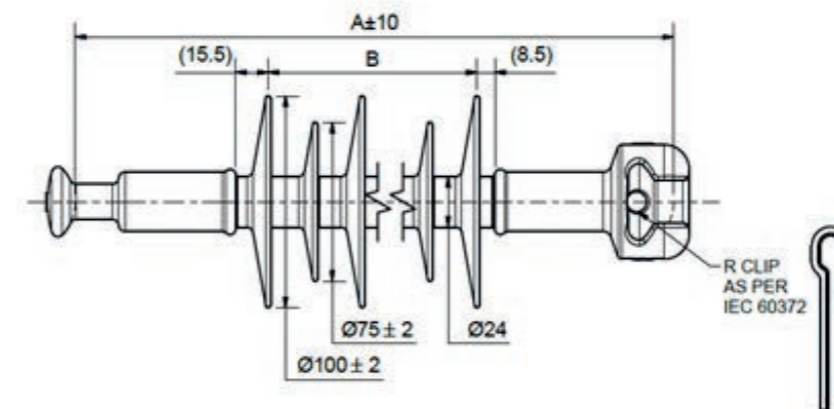

A wide range of end fittings is available with different housing profiles (with uniform or alternating shed arrangement). Please contact TE representative for details.

Metal End Fitting Selection for Suspension Insulators

- Ball **B**
- Socket **S**
- Eye **E**
- Y Clevis **Y**
- Clevis **C**
- Tongue **T**



SOCKET AND BALL INSULATORS – DIMENSIONS AND ELECTRICAL PROPERTIES

TCPN	Description	Creepage distance (mm)	Bottom Fitting	Creepage distance (mm)	Dry arc distance (mm)	No. of Sheds	Average Dry W/S Voltage (kV)	Average wet W/S Voltage (kV)	Imp W/S Voltage +ve (kV)	SCL (kN)	Section Length L (mm)
EN9516-000	CS-70-SB-100-0265-M-01	265	125	60	45	75	60	100	115	252	60
EN9517-000	CS-70-SB-115-0355-M-01	355	155	70	55	86	70	115	130	282	90
EN9518-000	CS-70-SB-130-0445-M-01	445	185	85	65	95	80	130	145	312	120
EN9519-000	CS-70-SB-145-0535-M-01	535	215	90	70	105	85	145	160	342	150
EN9520-000	CS-70-SB-165-0625-M-01	625	245	100	80	115	100	165	175	372	180
EN9521-000	CS-70-SB-180-0715-M-01	715	275	115	90	125	105	180	195	402	210
EN9522-000	CS-70-SB-200-0805-M-01	805	305	125	100	135	115	200	210	432	240
EN9523-000	CS-70-SB-215-0895-M-01	895	335	135	110	145	125	215	225	462	270
EN9524-000	CS-70-SB-230-0985-M-01	985	365	145	120	155	135	230	240	492	300
EN9525-000	CS-70-SB-245-1075-M-01	1075	395	155	130	165	145	245	255	522	330
EN9526-000	CS-70-SB-260-1165-M-01	1165	425	165	140	175	155	260	275	552	360
EN9527-000	CS-70-SB-275-1255-M-01	1255	455	175	145	185	165	275	290	582	390
EN9528-000	CS-70-SB-290-1345-M-01	1345	485	185	155	195	175	290	305	612	420
EN9529-000	CS-70-SB-310-1435-M-01	1435	515	195	165	205	180	310	320	642	450
EN9530-000	CS-70-SB-325-1525-M-01	1525	545	205	175	215	190	325	335	672	480
EN9531-000	CS-70-SB-340-1615-M-01	1615	575	215	185	225	200	340	350	702	510
EN9532-000	CS-70-SB-355-1705-M-01	1705	605	225	195	235	210	355	365	732	540
EN9533-000	CS-70-SB-370-1795-M-01	1795	635	235	200	245	220	370	385	762	570
EN9534-000	CS-70-SB-390-1885-M-01	1885	665	245	210	255	230	390	400	792	600
EN9535-000	CS-70-SB-405-1975-M-01	1975	695	255	220	265	240	405	415	822	630
EN9536-000	CS-70-SB-420-2065-M-01	2065	725	265	230	275	250	420	430	852	660
EN9537-000	CS-70-SB-435-2155-M-01	2155	755	280	240	285	260	435	445	882	690
EN9538-000	CS-70-SB-450-2245-M-01	2245	785	290	250	295	270	450	460	912	720
EN9539-000	CS-70-SB-470-2335-M-01	2335	815	300	260	305	275	470	475	942	750
EN9540-000	CS-70-SB-485-2425-M-01	2425	845	310	265	315	285	485	490	972	780

Higher creepage length insulators with alternating housing profile for high pollution environment are also available. Please contact your TE representative for more details.

Tension Insulators IEC Naming Convention

CS-XX-YY-BIL-ZZZZ-M-XX

- CS** - Composite suspension
- XX** - SML rating
- YY** - Top/bottom fitting
- BIL** - BIL (kV)
- ZZZZ** - Creepage distance (mm)
- M** - Manufacturing style
- (**M** = Molded in place or **O** = Overmold)
- XX** - Designation for special items such as fitting type, special packaging, extra galvanizing etc.

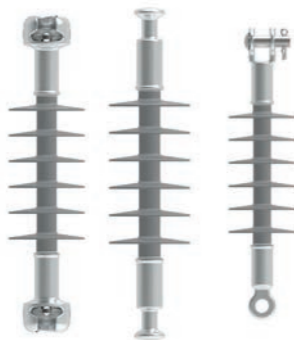

EPBI, EVA Standoff Insulators



GENERAL DESCRIPTION

The TE's Raychem EPBI is a lightweight direct molded composite insulator, using TE's Raychem proprietary EVA insulating material. The EVA is chemically bonded to the FRP core providing impenetrable interface sealing mechanism and the crimped assembly ensures optimal mechanical performance.

SELECTION INFORMATION: DIMENSIONS SHOWN IN MILLIMETERS

Product Series	EPBI – 1000	EPBI – 2000	EPBI – 3000
Part Description	EPBI-19R-PPS-25kN-M01	EPBI-27R-PPS-25kN-M01	EPBI-46R-PPS-25kN-M01
Length L (mm)	226	266	366
Standard min. stud length S (mm)	63	63	63
Standard min. stud length T (mm)	34	34	34
D1 (mm)	38	38	38
D2 (mm)	120	120	120
D3 (mm)	100	100	100
Creepage (mm)	497	687	1169
Number of sheds	4	6	11
Electrical			
Impulse withstand (kV)	159	185	252
Dry arc distance (mm)	205	244	347
Wet withstand (kV)	52	66	104
Mechanical			
Max bending moment (Nm)	580	580	580
MDCL (Nm)	290	290	290
Specified tensile load (kN)	25	25	25
Torque M12 (Nm)	50	50	50

RAP, EVA Polymeric Station Post Insulators



GENERAL DESCRIPTION

The TE's Raychem polymeric station post insulator RAP combines mechanical strength with excellent pollution performance. It consists of a pultruded fibre glass rod and a nontracking polymer housing which is directly bonded to the metal end fitting.

Corrosion resistant end fittings designed for high cantilever loads are crimped to both ends of the insulator

SELECTION INFORMATION: DIMENSIONS SHOWN IN MILLIMETERS

Description	Std Pkg	Pkg Weight	Pkg Volume
RAP-24R-A66-305	45 pcs	106 Kg (106 lbs)	0.510 m ³
RAP-36R-A66-350	45 pcs	115 Kg (254 lbs)	0.510 m ³
RAP-46R-A66-460	45 pcs	134 Kg (296 lbs)	0.510 m ³
RAP-52R-A66-475	45 pcs	139 Kg (307 lbs)	0.510 m ³

Dimensions in mm (inches)	RAP-24R-A66-305	RAP-36R-A66-350	RAP-46R-A66-460	RAP-52R-A66-475
Length	305 (12.0)	350 (13.78)	460 (18.11)	475 (18.7)
Dry arc distance	211 (8.31)	255 (10.0)	360 (14.17)	388 (15.28)
Creepage distance	631 (24.84)	809 (31.85)	1190 (46.85)	1333 (52.48)
No. of sheds	7	9	13	15
Diameter D1	120 (4.72)	120 (4.72)	120 (4.72)	120 (4.72)
Diameter D2	100 (3.94)	100 (3.94)	100 (3.94)	100 (3.94)
Diameter D3	37 (1.46)	37 (1.46)	37 (1.46)	37 (1.46)
Electrical values in kV	5.5	5.5	5.5	5.5
Dry AC withstand (flashover)	90 (100)	100 (>100)	115 (150)	115 (150)
Wet AC withstand (flashover)	50 (60)	75 (85)	110 (125)	110 (125)
Impulse withstand voltage	150	170	250	250
Mechanical values in kN	95	124	136	146
Specified Cantilever Load	12	10	7	6
Specified Tensile Load	25	25	25	25

NOTE Test report - PPR 1506 Summary test report for the PSI-36A-ZM12A-P, PSI-36A-Z2.6A-P, PSI-36ZM12A and PSI-36A-Z2.6A insulators
T97-456 5000h ageing test in accordance with IEC 1109 Annex C on one composite insulator type Post-F 5-4 25 kV

HSHI-RAYBOWL Hybrid Line Post Insulators

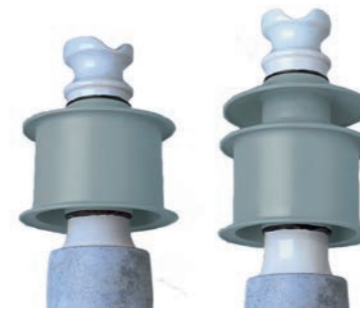

GENERAL DESCRIPTION

The TE's Raychem RayBowl line post insulator in a highly protected double bell geometry combines a ceramic core and a silicone elastomer housing to exploit the material property advantages of each component. A proven high strength ceramic core acts as the structural member to provide cantilever strength, while the silicone elastomer housing, in a highly protected geometry, provides the weathering resistance. The hydrophobic material property of the silicone elastomer reduces leakage current flow. Significant reduced power loss in combination with reduced maintenance costs provides direct economic benefit to the users.

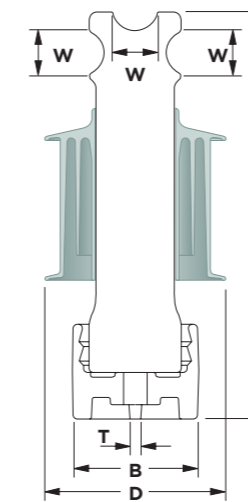

15 kV class

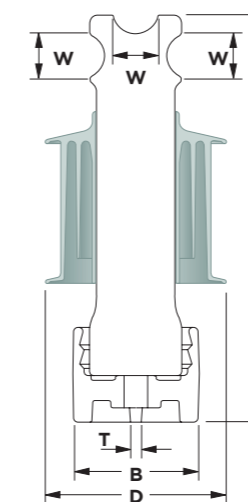

15 kV class

Technical Data

Dimensions	15 kV class		25 kV class	
Section length S (mm) [in]	290	[11.42"]	330	[12.99"]
Creepage distance (mm) [in]	540	[21.26"]	646	[25.43"]
Dry arc distance (mm) [in]	210	[8.28"]	241	[9.50"]
Shed diameter D (mm) [in]	136	[5.35"]	136	[5.35"]
Mounting pin thread T	3/4 UNC		3/4 UNC	
Net weight (kg) [lbs]	3.5	[7.7]	4.5	[9.9]
Wire groove diameter W (mm) [in]	31	[1.22"]	31	[1.22"]
Base diameter B (mm) [in]	86	[3.39"]	86	[3.39"]
Mechanical Ratings				
Cantilever strength (kN) [lb]	12.5	[2800]	12.5	[2800]
Electrical ratings				
Power frequency dry flashover (kV)	92		100	
Power frequency wet flashover (kV)	72		75	
Critical impulse flashover (kV)	145		160	
RIV @ 1000 kHz	<10 μV @ 15 kV		<10 μV @ 22 kV	

Ordering Information

Metric Ordering Description	Pin Length	Std Pkg	Pkg Weight	Pkg Volume
HSHI-RAYBOWL-DBELL-15KV	190 mm	3 pcs	12.7 kg	0.03 m ³
HSHI-RAYBOWL-DBELL-15KV-NP	no pin	3 pcs	11.0 kg	0.03 m ³
HSHI-RAYBOWL-DBELL-25KV	190 mm	3 pcs	13.7 kg	0.03 m ³
HSHI-RAYBOWL-DBELL-25KV-NP	no pin	3 pcs	12.0 kg	0.03 m ³

Imperial Ordering Description	Pin Length	Std Pkg	Pkg Weight	Pkg Volume
SHI-RAYBOWL-DBELL-15KV	4.83'	3 pcs	28.00 LB	1.05 FT3
HSHI-RAYBOWL-DBELL-15KV-NP	no pin	3 pcs	24.30 LB	1.05 FT3
HSHI-RAYBOWL-DBELL-25KV	4.83'	3 pcs	30.20 LB	1.05 FT3
HSHI-RAYBOWL-DBELL-25KV-NP	no pin	3 pcs	26.45 LB	1.05 FT3

Porcelain Disc Insulators



GENERAL DESCRIPTION

Insulators are made from high quality non porous electrical porcelain and galvanized ferrous (or non-ferrous) end fittings which provide long life and reliable performance over a wide range of environmental conditions. They are made to a number of international standards including ANSI, IEC, BS, AS and GB.

TE Connectivity (TE) offers a wide range of porcelain and glass disc insulators. For decades, these products have demonstrated reliable performance in various types of applications all over the world. Disc insulators are the traditional choice for distribution and transmission lines. Manufactured from high-quality materials, they provide long life and cost-effective solutions for a majority of applications.

FEATURES

- Different profiles to suit different environmental conditions
- Porcelain or toughened glass
- Metal components fixed with cement
- Mature technology based on years of experience in power distribution
- Quality design and manufacturing
- Long life and cost effective solutions for most applications
- Available to comply with IEC or ANSI international standards
- Reliable performance

APPLICATIONS

- Line conductor support and electrical separation from ground
- Distribution and transmission lines
- String insulators
- Available to 500kV applications

BENEFITS

- Excellent mechanical performance
- Highly durable / extended lifespan
- Materials are very resistant to UV, contaminant degradation and electric field degradation
- Standard end fittings

SELECTION INFORMATION: DIMENSIONS SHOWN IN MILLIMETERS

IEC Class			U70BL	U70BL	U80BL	U80BL	U120BS	U120BS	U120BL	U120BL
Standard Coupling to IEC 120	-	-	16A	16B	16A	16B	16A	16B	16A	16B
Part Numbers	Brown	-	2013	2096	2094	2085	2148	2150	2152	2154
	Grey	-	2012	2144	2147	2146	2149	2151	2153	2155
Porcelain Disc Diameter, D	-	mm	254	254	254	254	254	254	280	280
Unit Spacing, H	-	mm	146	146	146	146	146	146	170	170
Creepage Distance	-	mm	292	292	292	292	292	292	330	330
Combined M & E Strength	-	kN	70	70	80	80	120	120	120	120
Routine Test Load	-	kN	28	28	32	32	48	48	48	48
Impulse Withstand Voltage	-	kVp	110	110	110	110	110	110	110	110
50% Impulse	Pos	kVp	120	120	120	120	120	120	120	120
Flashover Voltage	Neg	kVp	125	125	125	125	125	125	125	125
Power Frequency	Dry	kV	70	70	70	70	70	70	70	70
Withstand Voltage	Pos	kV	40	40	40	40	40	40	40	40
Power Frequency	Dry	kV	78	78	78	78	78	78	78	78
Flashover Voltage	Wet	kV	45	45	45	45	45	45	45	45
Power Frequency Puncture Voltage		kV	110	110	110	110	110	110	110	110
Net Weight, Approx		kg	4.6	4.6	4.6	4.6	6	6	6	6

IEC Class	U70C		
Standard Coupling to IEC 120	-	-	16C
Part Numbers	Brown	-	2097
	Grey	-	2067
Porcelain Disc Diameter, D	-	mm	254
Unit Spacing, H	-	mm	146
Creepage Distance	-	mm	292
Combined M & E Strength	-	kN	70
Routine Test Load	-	kN	28
Impulse Withstand Voltage	-	kVp	110
50% Impulse	Pos	kVp	120
Flashover Voltage	Neg	kVp	125
Power Frequency	Dry	kV	70
Withstand Voltage	Pos	kV	40
Power Frequency	Dry	kV	78
Flashover Voltage	Wet	kV	45
Power Frequency Puncture Voltage		kV	110
Net Weight, Approx		kg	4.6

ELECTRICAL PROPERTIES OF INSULATOR STRINGS

When coupled together in strings, the electrical properties of discs cannot simply be added together in a linear fashion. Based on empirical data, the following table provides an example of how several key properties change as string length increases. of applications.

No of units in string	Diameter 255 / Pitch 146 (Standard)				Diameter 330 / Pitch 170 (Antifog)			
	Total Length	Power Frequency withstand (kV)		BIL (kV)	Total Length	Power Frequency withstand (kV)		BIL (kV)
		Dry	Wet			Dry	Wet	
1	146	70	40	100	170	90	55	140
2	292	130	75	195	340	150	105	235
3	438	180	115	275	510	210	150	335
4	584	235	155	360	680	265	190	435
5	730	280	195	430	850	320	230	535
6	876	325	230	505	1020	370	270	625
7	1022	375	265	580	1190	420	300	710
8	1168	420	300	660	1360	470	335	800
9	1314	465	325	730	1530	515	365	890
10	1460	510	375	800	1700	570	395	980
11	1606	550	410	880	1870	610	430	1070
12	1752	595	440	955	2040	660	460	1170
13	1898	635	475	1025	2210	700	490	1260
14	2044	675	510	1095	2380	745	520	1355
15	2190	715	540	1160	2550	785	550	1450
16	2336	755	570	1230	2720	830	575	1540
17	2482	800	600	1300	2890	870	605	1640
18	2628	855	635	1370	3060	910	630	1730
19	2774	875	665	1440	3230	950	655	1810
20	2920	915	700	1510	3400	990	680	1900
21	3066	950	730	1575	3570	1030	700	1990

TE PORCELAIN AND GLASS DISC RANGE

Catalogue Reference	Mechanical Failing Load (kN)	Maximum Nominal Diameter (mm)	Pitch (mm)	Nominal Creepage (mm)	Couplings	Coupling Size to	Retaining Clip / Coupling Pin	Approx Weight (kg)	Zinc Collar
DI-U70C292-PG	70	255	146	292	T&C	16C	Round	4	Yes
DI-U70C292-PGH	70	255	146	292	T&C	16C	Hex	4	No
DI-U70BL295-PBW	70	255	146	295	B&S	16B	W	4	No
DI-U70BL320-GVZW	70	255	146	320	B&S	16B	W	4	Yes
DI-U70C320-GV	70	255	146	320	T&C	16C	Round	4	No
DI-U70C320-GVZ	70	255	146	320	T&C	16C	Round	4	Yes
DI-U70BL400-GVZR	70	255	146	400	B&S	16B	R	5	Yes
DI-U80BL320-GVW	80	255	146	320	B&S	16B	W	4	No
DI-U80BL320-GVZW	80	255	146	320	B&S	16B	W	4	Yes
DI-U80BL390-GVZW	80	255	146	390	B&S	16B	W	5	Yes
DI-U100BL390-GVZR	100	255	146	390	B&S	16A	R	5	Yes
DI-U120BL292-PGW	120	255	146	292	B&S	16B	W	5	No
DI-U120BL320-GVZR	120	255	146	320	B&S	20	R	4	Yes
DI-U125BS320-GVZW	125	255	146	320	B&S	20	W	4	Yes
DI-U160BS305-PGW	160	280	146	305	B&S	20	W	8	No
DI-U160BS440-PGZR	160	280	146	440	B&S	20	R	9	Yes
DI-U160BS445-GVZW	160	280	146	445	B&S	16B	W	6	Yes
DI-U160BS570-PBZR	160	330	146	570	B&S	20	R	12	Yes
DI-U190BS550-GVZW	190	330	170	550	B&S	24	W	10	Yes
DI-U210BS370-PBZR	210	300	170	370	B&S	20	R	12	Yes
DI-U210BS450-PBZR	210	330	170	450	B&S	20	R	16	Yes
DI-U300BP505-PGZR	300	400	195	505	B&S	24	R	20	Yes

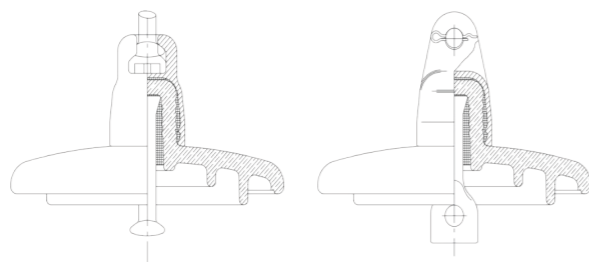

DI-Uxxx-B L zzz-M F n Z c

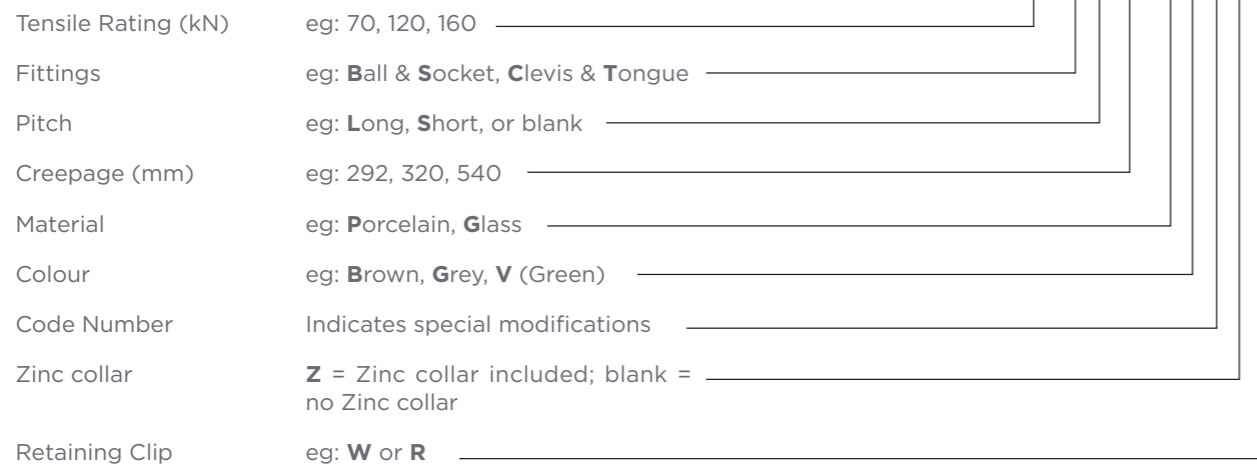

Porcelain Station Post Insulators

up to 500 kV, quality design



KEY FEATURES

- Quality design and manufacturing
- Complies with ANSI C29.9
- Available to 500kV applications
- Long life and cost effective solutions for most applications
- Available in Gray or Brown
- Reliable performance
- Standard bolt circles and standard end fittings

GENERAL DESCRIPTION

TE Connectivity (TE) offers a wide range of porcelain station post insulators. For decades, these products have demonstrated reliable performance in various types of applications all over the world.

Porcelain insulators are the traditional choice for distribution and transmission line, busbar and apparatus insulation. Manufactured from high-quality non-porous electrical porcelain, they provide long life and cost-effective solutions for a majority of applications. TE's porcelain insulators were also sold in the past with brand names of Morlynn, Dulmison and Zibo and have 95 years of service experience in electric power supply.

PRODUCT SELECTION INFORMATION

Description	Strength	BIL (kV)	System Voltage (kV)	Overall Height (in)	Bolt Circle Diameter Top/Bottom (in)	Leakage Distance (in)	Cantilever Strength (lbs)
SP-TR202PG	STD	95	7.5	7.5	3	10.5	2000
SP-TR222PG	High	95	7.5	10	5	10.5	4000
SP-TR222PG01	Ex-High	95	7.5	10	5	10.5	8000
SP-TR205PG	STD	110	15	10	3	15.5	2000
SP-TR225PG	High	110	15	12	5	15.5	4000
SP-TR225PG01	Ex-High	110	15	12	5	15.5	8000
SP-TR208PG	STD	150	25	14	3	24	2000
SP-TR227PG	High	150	25	15	5	24	4000
SP-TR227PG01	Ex-High	150	25	15	5	24	8000
SP-TR210PG	STD	200	35	18	3	37	2000
SP-TR231PG	High	200	25	20	5	37	4000
SP-TR231PG01	Ex-High	200	25	20	5	37	8000
SP-TR214PG	STD	250	46	22	3	43	2000
SP-TR267PG	High	250	46	24	5	43	4000
SP-TR267PG01	Ex-High	250	46	25	7	43	8000
SP-TR216PG	STD	350	69	30	3	72	1500
SP-TR278PG	High	350	69	30	5	72	3000
SP-TR278PG01	Ex-High	350	69	32	7	72	6000
SP-TR286PG	STD	550	115	45	5	99	1700
SP-TR287PG	High	550	115	45	5	99	2600
SP-TR287PG01	Ex-High	550	115	45	7	99	5000
SP-TR288PB	STD	650	138	54	5	116	1400
SP-TR289PG	High	650	138	54	5	116	2200
SP-TR289PG01	Ex-High	650	138	54	5/7	116	4100
SP-TR291PG	STD	750	161	62	5	132	1200
SP-TR295PG	High	750	161	62	5	132	1850
SP-TR295PG01	Ex-High	750	161	62	7	132	3500

SP-TR304PG	STD	900	230	80	5	165	950
SP-TR308PG	High	900	230	80	5	165	1450
SP-TR312PG	STD	1050*	345	92	5	198	800
SP-TR316PG	High	1050*	345	92	5	198	1250
SP-TR324PG	STD	1300*	345	106	5	231	1000
SP-TR367PG	High	1300*	345	106	5/7	231	1450
SP-TR368PG	Ex-High	1300*	345	106	7	231	2000
SP-TR369PG	Ex-High	1300*	345	106	5/7	231	2050
SP-TR369PG02	Ex-High	1300*	345	106	5/7	231	3500
SP-TR330PG	STD	1470*	500	122	5	264	900
SP-TR371PG	High	1470*	500	122	5/7	264	1170
SP-TR373PG	Ex-High	1470*	500	122	5/7	264	1750
SP-TR372PG	Ex-High	1470*	500	122	7	264	1750
SP-TR379PG	Ex-High	1550*	500	128	7	280	1700
SP-TR391PG	STD	1800*	500	152	5/7	330	1400
SP-TR391PG02	High	1800*	500	152	5/7	360	1750
SP-TR391PG03	Ex-High	1800*	500	152	5/7	360	4000

* NOTE Items available with optional corona ring



Chapter VII Surge Arresters

LV Surge Arresters.....	178
DOV Medium Voltage Surge Arresters.....	180
OCP Open Cage Polymeric Series	182
HDA Raychem Distribution Arresters.....	185
CPA Surge Arresters for Cable Sheath Protection System.....	188
MPA Raychem MV Surge Arresters for Indoor Applications.....	189
SPA Raychem MV Surge Arresters for Indoor Applications.....	190
RDA Raychem MV Surge Arresters for Indoor Applications.....	191
MCA/MDA HV Single Column Porcelain Surge Arresters	192
HV Single Column Polymeric Surge Arresters.....	198
TLA HV Transmission Line Surge Arresters	202

LV Surge Arresters

FEATURES

- Suitable for indoor and outdoor use
- Integrated disconnecter and 1 m line lead
- Overhead lines housing and lead are flame retardant and UV resistant
- Easy to identify failure indicator
- Easy to install (no tools required)
- Large selection of standard accessories
- CE certified
- Tested according IEC 61643-1 + Amd.1 and EN 61643-11

APPLICATIONS

- Protection for low voltage overhead lines, consumer in-house supplies, distribution transformers and other systems.
- Protection for consumer-side networks and equipment
- Metal-oxide varistor enclosed in a sturdy, weatherproof polymer housing for outdoor installation
- Special insulated adapters for use in insulated overhead-line systems and low-voltage bushings of distribution transformers

BENEFITS

- Low-value limits on surges caused by atmospheric overvoltages and switching transients
- Varistor with very short response time (typically <100 ns) and safe handling of high-current impulses up to 100 kA, 4/10 μs.
- Nominal discharge current 10 kA
- Compliance with Class II IEC 61643-1

GENERAL DESCRIPTION

TE's Raychem low voltage surge arresters provide protection for low-voltage overhead lines, consumer in-house supplies, distribution transformers and other systems.

The varistor has a very short response time (typically <100 ns) and can safely handle high-current impulses up to 100 kA, 4/10ms. The arrester's nominal discharge current is 10 kA.

The LVA surge arresters are in compliance with requirements Class II as defined by IEC 61643-1.

ORDERING INFORMATION

Selection Information: dimensions shown in millimeters

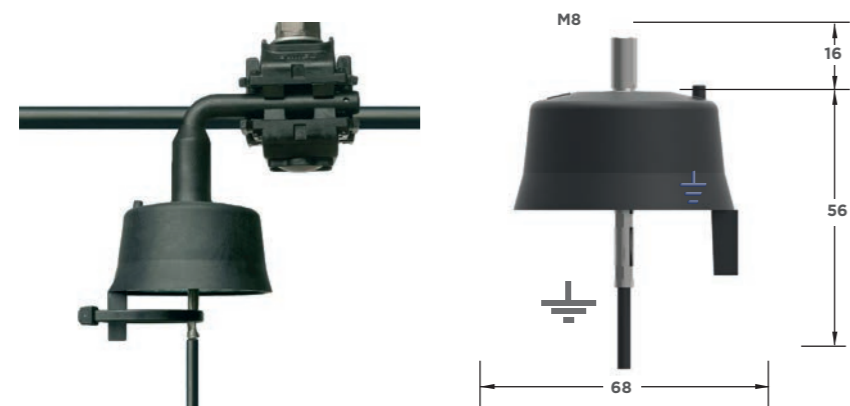

ACCESSORIES FOR LVA ARRESTERS

Line connection

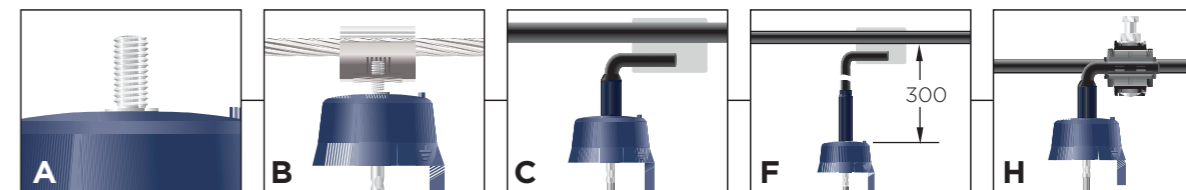

Surge arrester continuous/rated voltage (V)

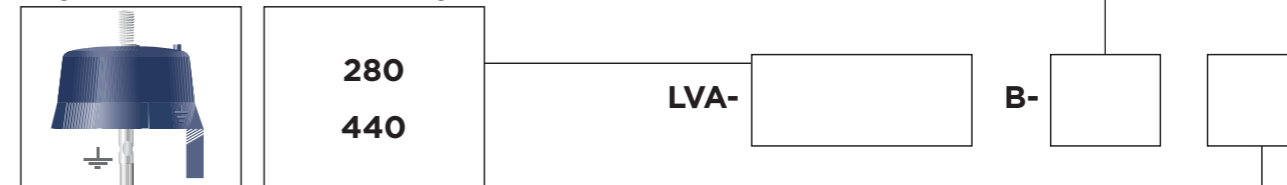

Ground lead

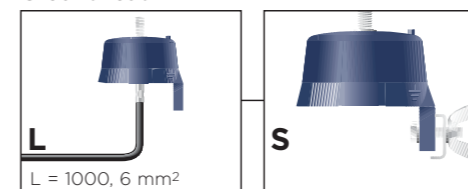

Ordering example: LVA-280B-BL
Surge arrester for continuous/rated voltage 280V for connection to bare conductor and with insulated stranded earth wire (6 mm²)

TECHNICAL DATA

Type	Continuous Voltage Uc (V)	Lightning 1 kA	Current 2 kA	Impulse 5 kA	8/20 μs 10 kA	20 kA	
LVA-280 B	280	0.73	0.77	0.85	1.0	1.1	no lead (Acc. S)
		0.76	0.82	0.96	1.2	1.58	with 15 cm lead
LVA-440 B	440	1.26	1.32	1.44	1.6	1.79	no lead (Acc. S)
		1.29	1.38	1.55	1.8	2.21	with 15 cm lead

DOV Medium Voltage Surge Arresters

GENERAL DESCRIPTION

The Distribution OverVoltage (DOV) surge arrester provides active over voltage protection that contributes directly to improved system reliability, reducing lost minutes and protecting expensive assets on the electrical network.

The 10 kA DH class distribution arrester has a voltage range from 3 to 36 kV (Ur) it has been type tested in an European high voltage laboratory and independently approved by accredited lab to meet the requirements of IEC Standard 60099-4, Ed. 3.0. The DOV surge arrester is the latest gapless, zinc oxide arrester family TE's Bowthorpe EMP range. The cage design development was based on over 40 years of internal experience in arrester design. The DOV core arresters are manufactured using excellent ZnO varistors, which display superior thermal and current handling characteristics due to the guaranteed homogeneity of the varistor volume. The DOV surge arresters are manufactured to the excellent quality providing exceptional operating performance and long service life.

FEATURES

- ZnO, (Zinc Oxide) varistors
- TE's Bowthorpe proprietary silicone housing
- Flame retardant FRP structure
- Corrosion resistant aluminium Fittings
- Suitable for indoor and outdoor use
- Large selection of standard accessories

APPLICATIONS

- The crimped structural construction ensures light weight product with optimal mechanical strength
- The manufacturing process ensures void free construction and optimum interface sealing. This is achieved by bonding the silicone housing directly to the ZnO discs and aluminium fittings using a bonding solution.
- The silicone housing was developed using the knowledge accumulated over 40 years of internal materials science expertise and experience, resulting in an optimum shed profile and a material with superior tracking and erosion resistance
- Alternating sheds for excellent pollution flash over resistance
- Excellent TERT performance
- All eventual failures by erosion only, ie no tracking in step voltage test
- Type Tests are independently verified in accordance with IEC60099-4, Ed 3.0

BENEFITS

- Active overvoltage protection for distribution network
- Improves system reliability by reducing downtime caused by overvoltage incidents
- Strong protection for most expensive assets on electrical network
- Based on proven technology and more than 40 years of experience in arrester design
- Manufactured to the excellent quality providing exceptional operating performance and long service life

TECHNICAL DATA

Catalog number

TECHNICAL DATA	RANGE
Commercial Designation	DOV
DOV Series - Rated Voltage range (Ur)	3-36kV
Creepage	394 -1128mm
Rated discharge current (8/20µs)	10 kA
Energy Classification according to IEC 60099-4 (Ed. 3.0)	DH
Repetitive Charge transfer rating (Qrs)	0,4
Thermal Charge transfer rating (Qth)	1,1
High current short circuit: (pre-failing method)	20kA
SSL	225Nm
SLL	175Nm

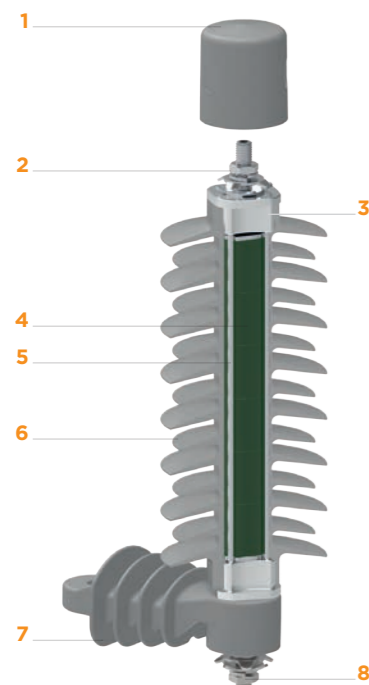

- | | |
|---------------------|--|
| 1. Birdcap | 6. Silicon housing |
| 2. Line Accessories | 7. Insulating Bracket and Disconnecter |
| 3. End fitting | 8. Earth Accessories |
| 4. ZnO Varistors | |
| 5. FRP Rods | |

DOV STANDARD HOUSING PARAMETERS & RATED VOLTAGE COMPATIBILITY

Selection information: Dimensions in inches/feet (millimeters/meters)

Maximum Rating (Ur - kV)	No. of Sheds	Flashover Distance (mm)	Creepage Length (mm)	Arrester (body) Height (mm)	Dimension Ø S1	Dimension Ø S2	Lightning Impulse 1.2/50µs (kV)	Power frequency withstand Voltage (wet) (kV)	Power frequency withstand Voltage (wet) (kV)
					(mm)	(mm)			
Housing 'A' < 12 kV	6	162	405	160	105	93	174	46	46
Housing 'B1' < 22 kV	11	234	697	229	105	93	185	72	72
Housing 'C' < 24 kV	13	266	817	258	105	93	203	87	87
Housing 'D' < 30 kV	15	304	945	298	105	93	230	98	98
Housing 'E' < 36 kV	15	318	1128	298	120	103	243	103	103

DOV STANDARD ELECTRICAL DATA

Selection information: Dimensions in inches/feet (millimeters/meters)

Product Description	Rated Voltage (Ur)	Continuous Operating Voltage (Uc)	Residual Voltage - kV				
			Lightning - [8/20µs]		Switching - [30/60µs]	Fast front - [1/2µs]	Extended Housing
			5kA	10kA			
DOV-3A	3,5	2,8	12,6	13,7	10,4	15,1	B, C, D or E
DOV-4A	4,5	3,6	12,6	13,7	10,4	15,1	B, C, D or E
DOV-5A	5	4	16,8	18,3	13,9	20,1	B, C, D or E
DOV-6A	6	4,8	16,8	18,3	13,9	20,1	B, C, D or E
DOV-9A	9	7,2	25,2	27,4	20,8	30,1	B, C, D or E
DOV-10A	10,5	8,4	29,4	32	24,3	35,2	B, C, D or E
DOV-12A	12	9,6	33,7	36,6	27,8	40,3	B, C, D or E
DOV-13B	13,5	10,8	37,3	40,5	30,8	44,6	C, D or E
DOV-15B	15	12	41,4	45	34,2	49,5	C, D or E
DOV-16B	16,5	13,2	45,5	49,5	37,6	54,5	C, D or E
DOV-18B	18	14,4	49,7	54	41	59,4	C, D or E
DOV-19B	19,5	15,6	53,8	58,5	44,5	64,4	C, D or E
DOV-21B	21	16,8	58	63	47,9	69,3	C, D or E
DOV-22B	22,5	18	62,1	67,5	51,3	74,3	C, D or E
DOV-24C	24	19,2	66,2	72	54,7	79,2	D or E
DOV-27D	27	21,6	74,5	81	61,6	89,1	D or E
DOV-28D	28,5	22,8	78,7	85,5	65	94,1	D or E
DOV-30D	30	24	82,8	90	68,4	99	D or E
DOV-31E	31,5	25,2	86,9	94,5	71,8	104	-
DOV-33E	33	26,4	91,1	99	75,2	108,9	-
DOV-36E	36	28,8	99,4	108	82,1	118,8	-

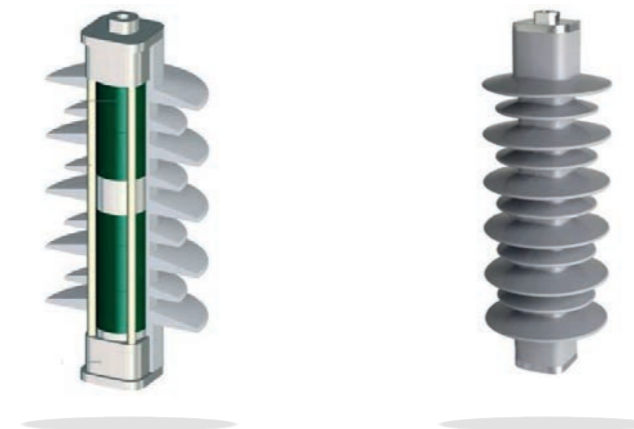

OCP Open Cage Polymeric Series

FEATURES

- Suitable for indoor and outdoor use
- Alternating sheds for excellent pollution flash over resistance
- Excellent TERT performance
- Housing tested to IEC 1000hr salt fog test
- Constant voltage: 4.5 kV, >360min
Step voltage: >300min - All eventual failures by erosion only, ie no tracking in voltage test

APPLICATIONS

- Active overvoltage protection for distribution network
- Improves system reliability by reducing downtime caused by overvoltage incidents
- Strong protection for most expensive assets on electrical network
- Based on proven technology and more than 40 years of experience in arrester design

BENEFITS

- Tested in accordance with IEC60099-4 at independent accredited laboratories
- Excellent protection margins
- Direct molded housing to prevent moisture ingress
- Low residual voltages
- High-energy handling
- Excellent TOV performance
- Safe non-shattering short circuit behavior to higher current levels
- Maintenance free
- Hydrophobic silicone housing: (Tracking and erosion resistant)
- Superior cantilever and tensile performance
- Excellent mechanical, vibration and impact withstand capability
- Quality design and manufacturing, ISO 9001 and 14001 compliant



Selection Information: dimensions shown in millimeters

OCP0	U Continuous kV(r.m.s)	U Rated kV(r.m.s)	U Residual in kV When Tested to the Following Impulse Waveforms			
			Lightning (8/20µs)			Steep Lightning (1/20 µs)
			2.5 kA	5 kA	10 kA	5 kA
3	3	3.7	9.12	9.78	10.68	10.18
4	4	5.0	12.16	13.04	14.24	13.57
5	5	6.2	15.20	16.30	17.80	16.96
6	6	7.5	18.24	19.56	21.36	20.35
8	8	10.0	24.32	26.08	28.48	27.14
9	9	11.2	27.36	29.34	32.04	30.53
10	10	12.5	30.40	32.60	35.60	33.92
12	12	15.0	36.48	39.12	42.72	40.70
15	15	18.7	45.60	48.90	53.40	50.88
18	18	22.5	54.72	58.68	64.08	61.06
20	20	25.0	60.80	65.20	71.20	67.84
21	21	26.2	63.84	68.46	74.76	71.23
22	22	27.5	66.88	71.72	78.32	74.62
24	24	30.0	72.96	78.24	85.44	81.41
29	29	36.3	88.16	94.54	103.24	98.37

OCP1	U Continuous kV(r.m.s)	U Rated kV(r.m.s)	U Residual in kV When Tested to the Following Impulse Waveforms					
			Lightning (8/20 µs)			Steep Lightning (1/20 µs)	Switching (30/60 µs)	
			5 kA	10 kA	20 kA	10 kA	125 A	500 A
3	3	3.7	9.77	10.37	11.48	11.28	7.81	8.08
4	4	5.0	13.03	13.83	15.31	15.04	10.42	10.77
5	5	6.2	16.29	17.29	19.14	18.80	13.02	13.46
6	6	7.5	19.55	20.75	22.97	22.56	15.62	16.15
8	8	10.0	26.06	27.66	30.62	30.08	20.83	21.54
9	9	11.2	29.32	31.12	34.45	33.84	23.44	24.23
10	10	12.5	32.58	34.58	38.28	37.60	26.04	26.92
12	12	15.0	39.10	41.50	45.94	45.12	31.25	32.30
15	15	18.7	48.87	51.87	57.42	56.40	39.06	40.38
18	18	22.5	58.64	62.24	68.90	67.68	46.87	48.46
20	20	25.0	65.16	69.16	76.56	75.20	52.08	53.84
21	21	26.2	68.42	72.62	80.39	78.96	54.68	56.53
22	22	27.5	71.68	76.08	84.22	82.72	57.29	59.22
24	24	30.0	78.19	82.99	91.87	90.24	62.50	64.61
29	29	36.3	94.48	100.28	111.00	109.04	75.52	78.07

OCP2	U Continuous kV(r.m.s)	U Rated kV(r.m.s)	U Residual in kV When Tested to the Following Impulse Waveforms					
			Lightning (8/20 µs)			Steep Lightning (1/20 µs)	Switching (30/60 µs)	
			5 kA	10 kA	20 kA	10 kA	125 A	500 A
3	3	3.7	9.18	9.72	10.84	10.10	7.37	7.76
4	4	5.0	12.24	12.96	14.46	13.47	9.83	10.35
5	5	6.2	15.30	16.20	18.07	16.84	12.29	12.94
6	6	7.5	18.36	19.44	21.68	20.21	14.75	15.53
8	8	10.0	24.48	25.92	28.91	26.94	19.66	20.70
9	9	11.2	27.54	29.16	32.53	30.31	22.12	23.29
10	10	12.5	30.60	32.40	36.14	33.68	24.58	25.88
12	12	15.0	36.72	38.88	43.37	40.42	29.50	31.06
15	15	18.7	45.90	48.60	54.21	50.52	36.87	38.82
18	18	22.5	55.08	58.32	65.05	60.62	44.24	46.58
20	20	25.0	61.20	64.80	72.28	67.36	49.16	51.76
21	21	26.2	64.26	68.04	75.89	70.73	51.62	54.35
22	22	27.5	67.32	71.28	79.51	74.10	54.08	56.94
24	24	30.0	73.44	77.76	86.74	80.83	58.99	62.11
29	29	36.3	88.74	93.96	104.81	97.67	71.28	75.05

	OCP0	OCP1	OCP2
U_c	3-29 kV	3-29 kV	3-29 kV
I_N	5 kA	10k A	10k A
High current impulse	65 kA	100 kA	100 kA
Long duration energy (2 shots / kJ/kV U_c)	1.2 kJ/kV U_c	4.1 kJ/kV U_c	6.0 kJ/kV U_c
Long duration waveform	200 A / 1 ms	350 A / 2 ms	530 A / 2 ms
10 second TOV (U_{TOV} / U_c)	1.44	1.43	1.35
High current short circuit	20 kA	25 kA	40 kA
Core technology	OCP	OCP	OCP

OCP series naming and order query description:

Example: OCP = "Open Cage Polymeric"

Line discharge class:

- 0 = 5kA, 65kA high current
- 1 = 10kA, 100kA high current, class 1
- 2 = 10kA, 100kA high current, class 2

U_c

Housing creepage:

- S = standard creepage
- L = extended creepage

Accessory selection

- M = Mounting bracket
- E = Earth connection
- L = Line connection

OCP0 - 12S - ABC

System Voltage U_m	ph/ph (a)	ph/ground (b)
12	185	165
24	315	295
36	445	425

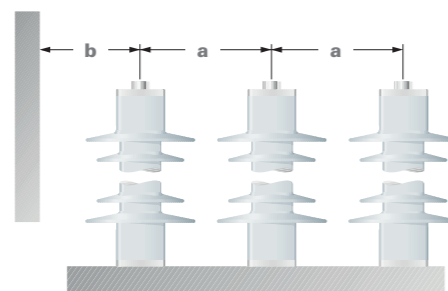

Line lead accessories

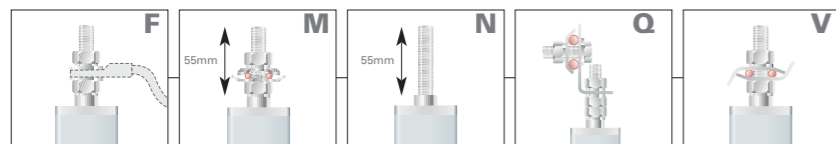

Arrester Type = Continuous Operating Voltage U_c in kV

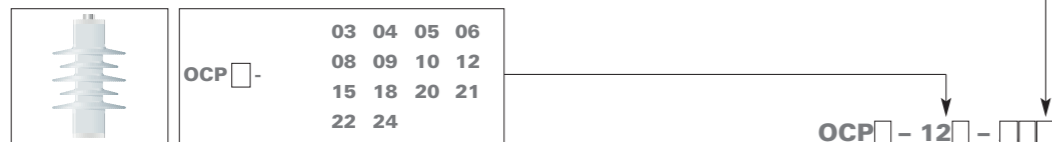

Mounting accessories

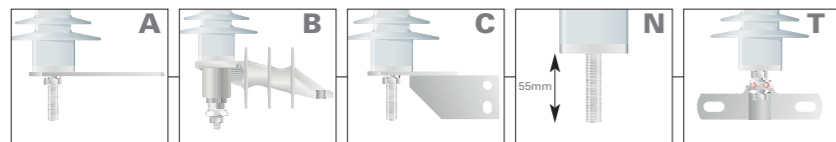

Ground lead accessories

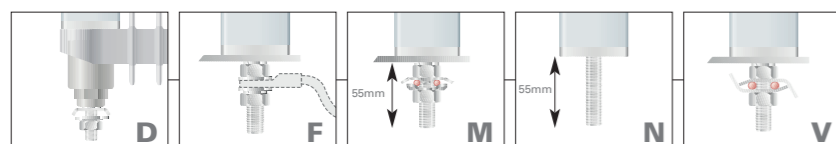

Additional accessory options available on request. Please contact: surgearresters@tycoelectronics.com with your specific requirement.

HDA Raychem Distribution Arresters

FEATURES

- Alternating sheds for excellent pollution flash over resistance
- Excellent TERT performance
- All eventual failures by erosion only, ie no tracking in step voltage test
- Housing tested to IEC 1000hr salt fog test
- Direct moulded housing to prevent moisture ingress
- Tested in accordance with IEC60099-4 at independent accredited laboratories

APPLICATIONS

- Excellent performance in heavy pollution environment applications
- Based on proven Raychem technology and more than 50 years of experience in materials design
- Protection of MV networks and equipment from lightning and switching surge related over-voltages in areas with relatively high iso-keraunic levels
- Suitable for both outdoor and indoor use to protect transformers and cable
- End terminations

BENEFITS

- Excellent TOV performance
- Safe, non-shattering failure in the short circuit test by pre-failing to higher fault currents
- High energy handling capability
- Excellent protection margins
- Direct molded housing to prevent moisture ingress
- Maintenance free
- Hydrophobic EVA housing
- Quality design and manufacturing, ISO 9001 and 14001 compliant

DESCRIPTION

Raychem pioneered the development of polymeric housed surge arresters in the early 1980's and since 1986 have a proven service experience across the globe, operating in the worlds toughest environments. Raychem HDA Ethyl Vinyl Acetate (EVA) surge arresters have been designed and tested to meet our customers toughest environmental conditions and to meet the requirements of IEC60099-4.

The final HDA qualifications are performed by an independent laboratory in Europe.HDA is the latest gapless, zinc oxide arrester family from Raychem.

At the core of the Raychem HDA design is our improved ZnO varistor disk, which has excellent thermal and electrical characteristics and stability. This new varistor and HDA design combination results in excellent energy handling and TOV performance. The crimped structural construction offers a light weight product with optimal mechanical strength. The manufacturing process ensures void free construction and optimum interface sealing. This is achieved by bonding the EVA housing directly to the ZnO discs and aluminium fittings using a Raychem proprietary bonding solution.

Generic technical data		
Voltage Application	3-41 kV U_c	
Rated discharge current (8/20 μ s):	10 kA	
Line discharge class according to IEC 60099-4	Class 1	
Operating duty impulse withstand current (4/10 μ s):	100 kA	
Long duration current impulse (2000 μ s):	400 A	
10 second temporary overvoltage (U_{TOV}/U_c)	1.42	
High current short circuit: (pre-failing method)	40 kA	
Energy	2 line discharge impulse	4.2 kJ/kV U_c
	2 high current impulse	6.8 kJ/kV U_c
Service conditions Ambient temperature	- 60°C to + 60°C	

HDA-MA Standard electrical data

HDA-xxMA	U continuous kV(r.m.s)	U rated kV(r.m.s)	U residual in kV when tested to the following impulse waveforms					
			Lightning (8/20 μ s)			Steep lightning (1/20 μ s)	Switching (30/60 μ s)	
			5 kA	10 kA	20 kA	10 kA	125 A	500 A
3	3	3,75	9,3	9,9	10,9	10,2	7,4	7,9
4	4	5	12,4	13,2	14,6	13,6	9,8	10,5
6	6	7,5	18,6	19,8	21,8	20,4	14,8	15,7
8	8	10	24,8	26,4	29,1	27,2	19,7	21
9	9	11,25	27,9	29,7	32,8	30,6	22,1	23,6
10	10	12,5	31	33	36,4	34	24,6	26,2
12	12	15	37,2	39,6	43,7	40,8	29,5	31,4
18	18	22,5	55,8	59,4	65,5	61,2	44,3	47,2
20	20	25	62	66	72,8	68	49,2	52,4
21	21	26,25	65,1	69,3	76,4	71,4	51,7	55
24	24	30	74,4	79,2	87,4	81,6	59	62,9

HDA-M Standard electrical data

HDA-xxM	U continuous kV(r.m.s)	U rated kV(r.m.s)	U residual in kV when tested to the following impulse waveforms					
			Lightning (8/20µs)			Steep lightning (1/20µs)	Switching (30/60µs)	
			5 kA	10 kA	20 kA	10 kA	125 A	500 A
26	26	32,5	80,6	85,8	94,6	88,4	64	68,1
27	27	33,75	83,7	89,1	98,3	91,8	66,4	70,7
29	29	36,25	89,9	95,7	105,6	98,6	71,3	76
30	30	37,5	93	99	109,2	102	73,8	78,6
33	33	41,25	102	108,9	120,1	112,2	81,2	86,5
36	36	45	112	118,8	131	122,4	88,6	94,3
39	39	48,75	121	128,7	142	132,6	95,9	102
40	40	50	124	132	145,6	136	98,4	105
41	41	51,25	127	135,3	149,2	139,4	101	107

HDA Standard housing parameters

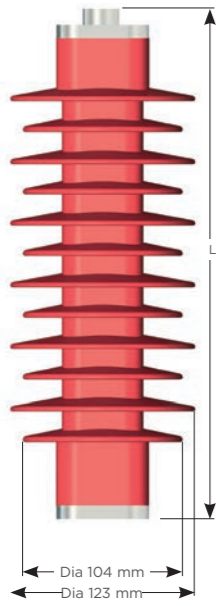

HDA-XXMA STANDARD HOUSING PARAMETERS

HDA-xxMA	Sheds	Impulse voltage 1.2/50µs	Power frequency withstand voltage, wet	Flash over distance	Creepage length	Height L	Weight (approx)
		(kV)	(kV)	(mm)	(mm)	(mm)	(kg)
03	5	106	47	176	380	183	1.8
04	5	106	47	176	380	183	1.8
06	5	106	47	176	380	183	1.8
08	5	106	47	176	380	183	1.8
09	5	106	47	176	380	183	1.8
10	5	106	47	176	380	183	1.8
12	5	106	47	176	380	183	1.8
18	12	190	93	310	830	316	3.25
20	12	190	93	310	830	316	3.25
21	12	190	93	310	830	316	3.25
24	12	190	93	310	830	316	3.25

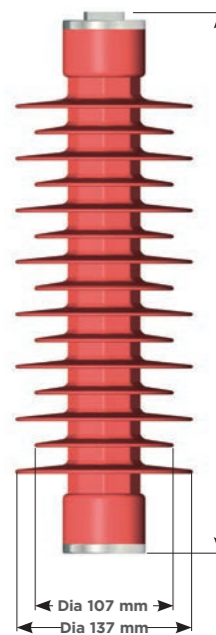

HDA-XXM STANDARD HOUSING PARAMETERS

HDA-xxMA	Sheds	Impulse voltage 1.2/50µs	Power frequency withstand voltage, wet	Flash over distance	Creepage length	Height L	Weight (approx)
		(kV)	(kV)	(mm)	(mm)	(mm)	(kg)
26	11	204	98	339	970	343	4
27	11	204	98	339	970	343	4
29	11	204	98	339	970	343	4
30	11	204	98	339	970	343	4
31	13	228	110	378	1125	383	4.5
33	13	228	110	378	1125	383	4.5
36	13	228	110	378	1125	383	4.5
39	15	250	122	418	1279	423	5
40	15	250	122	418	1279	423	5
41	15	250	122	418	1279	423	5

Accessories and Ordering Information

HDA SERIES NAMING AND ORDER QUERY DESCRIPTION:

Example:

HDA - 12MA - MEL

U_c: 3, 4, 6, 8, 9, 10, 12, 18, 20, 21, 24, 26, 27, 29, 30, 33, 36, 40, 41

Housing creepage:
M/MA = standard creepage
ML/LA = extended creepage

Accessory selection
M = Mounting bracket
E = Earth connection
L = Line connection

INSTALLATION REQUIREMENTS

System Voltage U _m	ph/ph (a)	ph/ground (b)
12	185	165
24	315	295
36	510	490

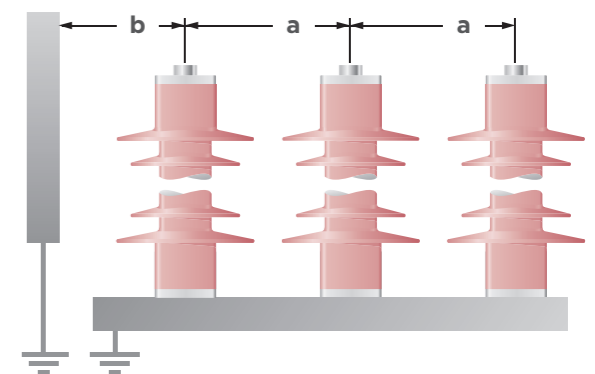

Mounting accessories

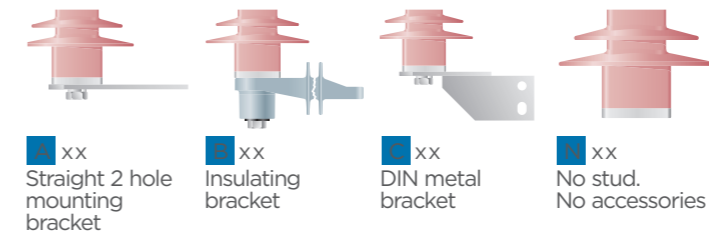

Earth lead accessories

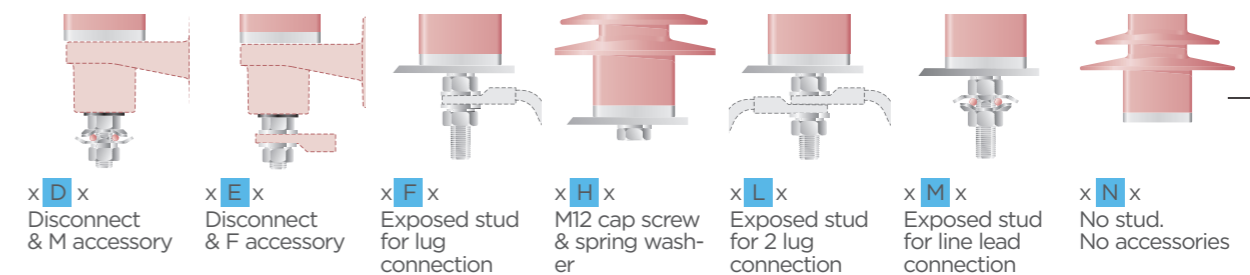

Line lead accessories

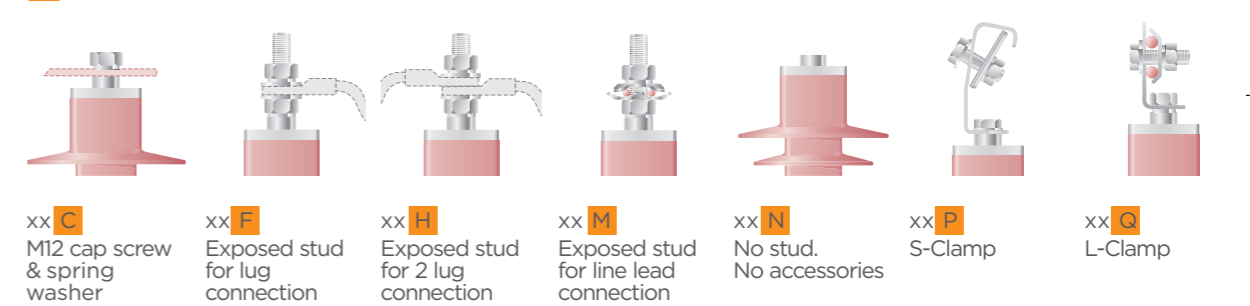

Additional accessory options available on request. Please contact: surgearresters@te.com with your specific requirement. All fasteners M12 unless stated otherwise.

CPA Surge Arresters for Cable Sheath Protection System

FEATURES

- Excellent TERT performance
- Non tracking housing
- High energy handling capabilities

APPLICATIONS

- Cable Sheath Protection or Sheath Voltage limiter (SVL)
- Based on proven Raychem technology and more than 30 years of experience in indoor arresters design
- Suitable for indoor use to protect assets and cable end terminations

BENEFITS

- High energy handling capability
- Excellent protection margins
- Maintenance free
- Hydrophobic Raychem housing
- Quality design and manufacturing, ISO 9001 and 14001 compliant

DESCRIPTION

This series of arresters is designed to allow installation of the arresters under the restricted space conditions typically found in switchgear applications.

Designed to the specific requirements in cable sheath protection. A robust, non tracking housing plus the high energy handling capabilities of the Raychem arrester family make it the ideal choice for the designer.

HIGH-VOLTAGE CABLE SHEATH PROTECTION SYSTEM CPA

Designed to the specific requirements in cable sheath protection. A robust, non tracking housing plus the high energy handling capabilities of the Raychem arrester family make it the ideal choice for the designer.

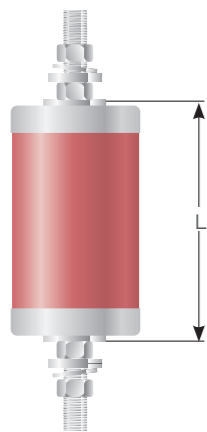

Generic technical data		
CPA-xx series		1-8 kV Uc
Rated discharge current (8/20µs):		10 kA
Line discharge class according to IEC 60099-4		Class 1
Operating duty impulse withstand current (4/10µs):		100 kA
Long duration current impulse (2000µs):		400 A
10 second temporary overvoltage (UTOV/UC)		1.3P
Energy	line discharge impulse	2.0 kJ/kV Uc
	high current impulse	3.2 kJ/kV Uc
Mechanical strength data		
Cantilever		200 Nm
Tensile		1000 N
Torque		58 Nm

CPA Standard electrical data

CPA	Height L (mm)	U continuous kV(r.m.s)	U rated kV(r.m.s)	U residual in kV when tested to the following impulse waveforms						
				Lightning (8/20µs)				Steep lightning (1/20µs)	Switching (30/60µs)	
				5 kA	10 kA	20 kA	40 kA	10 kA	125 A	500 A
CPA-01	85.5	1	1.25	3.1	3.3	3.6	4.2	3.6	2.4	2.6
CPA-02	95.5	2	2.5	6.1	6.6	7.3	8.3	7.1	4.9	5.2
CPA-03	107.5	3	3.75	9.2	9.9	11.0	12.5	10.7	7.3	7.8
CPA-04	115.5	4	5	12.3	13.2	14.6	16.6	14.2	9.8	10.4
CPA-05	126.5	5	6.25	15.4	16.6	18.2	20.8	17.8	12.2	13.0
CPA-06	137.5	6	7.5	18.5	19.9	21.9	24.9	21.3	14.7	15.6
CPA-07	144.5	7	8.75	21.6	23.2	25.5	29.1	24.9	17.1	18.2
CPA-08	151.5	8	10	24.6	26.6	29.1	33.3	28.5	19.5	20.8

MPA Raychem MV Surge Arresters for Indoor Applications

FEATURES

- Compact design
- Excellent TERT performance
- Non tracking housing
- High energy handling capabilities

APPLICATIONS

- Motor protection
- Based on proven Raychem technology and more than 30 years of experience in indoor arresters design
- Suitable for indoor use to protect motor applications and cable end terminations

BENEFITS

- High energy handling capability
- Maintenance free
- Hydrophobic Raychem housing
- Quality design and manufacturing, ISO 9001 and 14001 compliant

DESCRIPTION

MPA type Design for the specific requirements of electric motors. A robust, non-tracking housing plus the high energy handling capabilities of the TE Connectivity arrester family make it the ideal choice for the designer.

RAYCHEM MV SURGE ARRESTERS MPA FOR INDOOR APPLICATIONS

For motor-connection boxes

MPA type Design for the specific requirements of electric motors. A robust, non-tracking housing plus the high energy handling capabilities of the TE Connectivity arrester family make it the ideal choice for the designer.

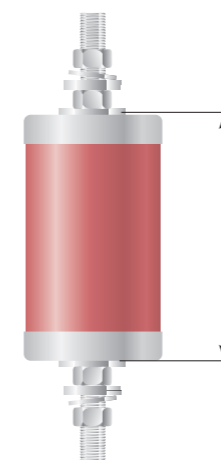

Generic technical data		
MPA-xx series		2-12 kV Uc
Rated discharge current (8/20µs):		10 kA
Line discharge class according to IEC 60099-4		Class 1
Operating duty impulse withstand current (4/10µs):		100 kA
Long duration current impulse (2000µs):		400 A
10 second temporary overvoltage (U _{10s} /U _c)		1.3
High current short circuit: (pre-failing method) (Safe non-shattering failure mode)		16 kA
Energy	line discharge impulse	2.0 kJ/kV Uc
	high current impulse	3.2 kJ/kV Uc
Mechanical strength data		
Cantilever		200 Nm
Tensile		1000 N
Torque		58 Nm

MPA Standard electrical data

MPA	Height L (mm)	U continuous kV(r.m.s)	U rated kV(r.m.s)	U residual in kV when tested to the following impulse waveforms						
				Lightning (8/20µs)				Steep lightning (1/20µs)	Switching (30/60µs)	
				5 kA	10 kA	20 kA	40 kA	10 kA	125 A	500 A
MPA-02	2	2.5	6.1	6.6	7.3	8.3	7.1	4.9	5.2	2.6
MPA-03	3	3.75	9.2	9.9	11.0	12.5	10.7	7.3	7.8	5.2
MPA-04	4	5	12.3	13.2	14.6	16.6	14.2	9.8	10.4	7.8
MPA-06	6	7.5	18.5	19.9	21.9	24.9	21.3	14.7	15.6	10.4
MPA-07	7	8.75	21.6	23.2	25.5	29.1	24.9	17.1	18.2	13.0
MPA-09	9	11.25	27.7	29.9	32.8	37.4	32.0	22.0	23.4	15.6
MPA-10	10	12.5	30.8	33.2	36.4	41.6	35.6	24.4	26.0	18.2
MPA-12	12	15	37.0	39.8	43.7	49.9	42.7	29.3	31.2	20.8

SPA Raychem MV Surge Arresters for Indoor Applications

FEATURES

- Excellent TERT performance
- Non tracking housing
- High energy handling capabilities
- Integrated line lead optional

APPLICATIONS

- Air-spaced insulated switchgear systems
- Based on proven Raychem technology and more than 30 years of experience in indoor arresters design
- Suitable for indoor use to protect switchgear and cable end terminations

BENEFITS

- High energy handling capability
- Allows reduction of air clearance in SWGR cable compartment
- Maintenance free
- Hydrophobic Raychem housing
- Quality design and manufacturing, ISO 9001 and 14001 compliant



DESCRIPTION

This is a compact arrester with high mechanical strength is fully track resistant and can provide flashover resistance in damp indoor conditions.

The SPA type arrester is also available with a thick-wall insulated integrated line lead, which allows to considerably reduce the clearances between the arresters and to the earth. This line lead is available in lengths of 250mm, 500mm and 750mm.

This SPA-I type arrester is the ideal solution when retrofitting compact switchgears with arresters.

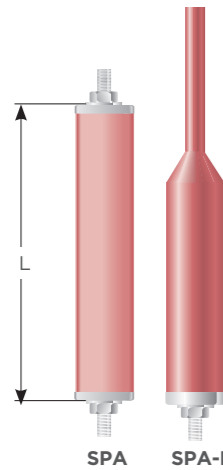

Generic technical data		
SPA-xx series		6-40 kV Uc
Rated discharge current (8/20µs):		10 kA
Line discharge class according to IEC 60099-4		Class 1
Operating duty impulse withstand current (4/10µs):		100 kA
Long duration current impulse (2000µs):		400 A
10 second temporary overvoltage (U _{TOV} /U _c)		1.3
High current short circuit: (pre-failing method) Safe non-shattering failure mode)		16 kA
Energy	line discharge impulse	2.0 kJ/kV Uc
	high current impulse	3.2 kJ/kV Uc
Mechanical strength data		
Cantilever		200 Nm
Tensile		1000 N
Torque		58 Nm

SPA Standard electrical data

SPA	Height L (mm)	U continuous kV(r.m.s)	U rated kV(r.m.s)	U residual in kV when tested to the following impulse waveforms						
				Lightning (8/20µs)				Steep lightning (1/20µs)	Switching (30/60µs)	
				5 kA	10 kA	20 kA	40 kA		10 kA	125 A
SPA-06	6	7.5	18.5	19.9	21.9	24.9	21.3	14.7	15.6	15.6
SPA-09	9	11.25	27.7	29.9	32.8	37.4	32.0	22.0	23.4	18.2
SPA-12	12	15	37.0	39.8	43.7	49.9	42.7	29.3	31.2	23.4
SPA-15	15	18.75	46.2	49.8	54.6	62.4	53.4	36.6	39.0	26.0
SPA-18	18	22.5	55.4	59.8	65.5	74.9	64.1	43.9	46.8	31.2
SPA-21	21	26.25	64.7	69.7	76.4	87.4	74.8	51.2	54.6	39.0
SPA-24	24	30	73.9	79.7	87.4	99.8	85.4	58.6	62.4	46.8
SPA-30	30	37.5	92.4	99.6	109.2	124.8	106.8	73.2	78.0	54.6
SPA-33	33	41.25	101.6	109.6	120.1	137.3	117.5	80.5	85.8	62.4
SPA-36	36	45	110.9	119.5	131.0	149.8	128.2	87.8	93.6	67.6
SPA-40	40	50	123.2	132.8	145.6	166.4	142.4	97.6	104.0	

RDA Raychem MV Surge Arresters for Indoor Applications

FEATURES

- Compact design
- Excellent TERT performance
- Non tracking housing
- High energy handling capabilities
- Integrated line lead optional

APPLICATIONS

- Gas insulated switchgear systems
- Based on proven Raychem technology and more than 30 years of experience in indoor arresters design
- Suitable for indoor use to protect switchgear and cable end terminations

BENEFITS

- High energy handling capability
- Allows reduction of air clearance in GIS SWGR cable compartment
- Maintenance free
- Fully integrated to Raychem RICS cable termination
- Hydrophobic Raychem housing
- Quality design and manufacturing, ISO 9001 and 14001 compliant



DESCRIPTION

In gas-insulated switchgear systems RDA type Modern gas-insulated switchgear connected to combined underground and overhead distribution systems are sensitive to effects like transient voltage doubling. An arrester installed right at the cable end juncture will clamp the voltage to a level which does not put the switchgear at risk.

The RDA surge arrester, together with the Raychem RICS connection system for gas-insulated switchgear, facilitates at hermetically sealed integration of the arrester and the cable termination to be connected to a switchgear.

Compact design and easy installation are the special features of this product line.

In gas-insulated switchgear systems RDA type Modern gas-insulated switchgear connected to combined underground and overhead distribution systems are sensitive to effects like transient voltage doubling. An arrester installed right at the cable end juncture will clamp the voltage to a level which does not put the switchgear at risk. The RDA surge arrester, together with the Raychem RICS connection system for gas-insulated switchgear, facilitates at hermetically sealed integration of the arrester and the cable termination to be connected to a switchgear. Compact design and easy installation are the special features of this product line.

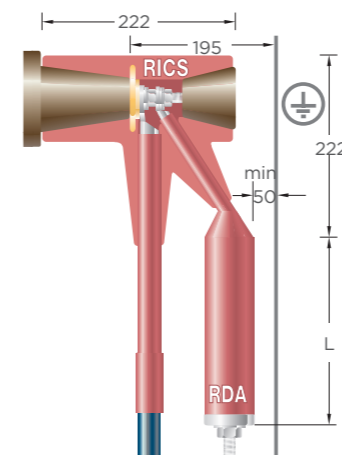

Generic technical data		
RDA-xx series		6-26 kV Uc
Rated discharge current (8/20µs):		10 kA
Line discharge class according to IEC 60099-4		Class 1
Operating duty impulse withstand current (4/10µs):		100 kA
Long duration current impulse (2000µs):		400 A
10 second temporary overvoltage (U _{TOV} /U _c)		1.3
High current short circuit: (pre-failing method) Safe non-shattering failure mode)		16 kA
Energy	line discharge impulse	2.0 kJ/kV Uc
	high current impulse	3.2 kJ/kV Uc
Mechanical strength data		
Cantilever		200 Nm
Tensile		1000 N
Torque		58 Nm

RDA Standard electrical data

CPA	Height L (mm)	U continuous kV(r.m.s)	U rated kV(r.m.s)	U residual in kV when tested to the following impulse waveforms						
				Lightning (8/20µs)				Steep lightning (1/20µs)	Switching (30/60µs)	
				5 kA	10 kA	20 kA	40 kA		10 kA	125 A
RDA-06	134	6	7.5	18.5	19.9	21.9	24.9	21.3	14.7	15.6
RDA-07	141	7	8.75	21.6	23.2	25.5	29.1	24.9	17.1	18.2
RDA-09	163	9	11.25	27.7	29.9	32.8	37.4	32.0	22.0	23.4
RDA-10	175	10	12.5	30.8	33.2	36.4	41.6	35.6	24.4	26.0
RDA-12	195	12	15	37.0	39.8	43.7	49.9	42.7	29.3	31.2
RDA-15	296	15	18.75	46.2	49.8	54.6	62.4	53.4	36.6	39.0
RDA-18	326	18	22.5	55.4	59.8	65.5	74.9	64.1	43.9	46.8
RDA-21	356	21	26.25	64.7	69.7	76.4	87.4	74.8	51.2	54.6
RDA-24	400	24	30	73.9	79.7	87.4	99.8	85.4	58.6	62.4
RDA-26	398	26	32.5	80.1	86.3	94.6	108.2	92.6	63.4	67.6

Arresters for other voltages are available on request

MCA/MDA HV Single Column Porcelain Surge Arresters

FEATURES

- High-energy handling
- Extremely strong mechanical strength
- Designed and manufactured to the current IEC60099-4: 2014 standard
- The surge arrester comprises of a number of ZnO elements situated within a Porcelain housing and sealed against moisture ingress

APPLICATIONS

- Active overvoltage protection for Substation equipment
- Improves system reliability by reducing downtime caused by overvoltage incidents
- Strong protection for most expensive assets on Substation
- Based on proven technology and more than 40 years of experience in arrester design

BENEFITS

- Tested in accordance with IEC60099-4 at independent accredited laboratories
- Quality design and manufacturing, ISO 9001 and 14001 compliant
- Seal design ensuring a long service life

Generic Technical Data

		MCA	MDA
Maximum system voltage U_m	kV	420	550
System voltage U_s	kV	400	500
Nominal discharge current	kA	10	20
High current impulse (4/10 μ s)	kA	100	100
Arrester class designation	-	SM	SH
Repetitive charge transfer rating Q_{rs}	C	2,2	3
Rated thermal energy W_m at U_r	kJ/kV	7	10
Rated short circuit current	kA	65	65
Cantilever load	-	-	-
Specified long-term load (SLL)	kNm	5	5
Specified short-term load (SSL)	kNm	12,5	12,5

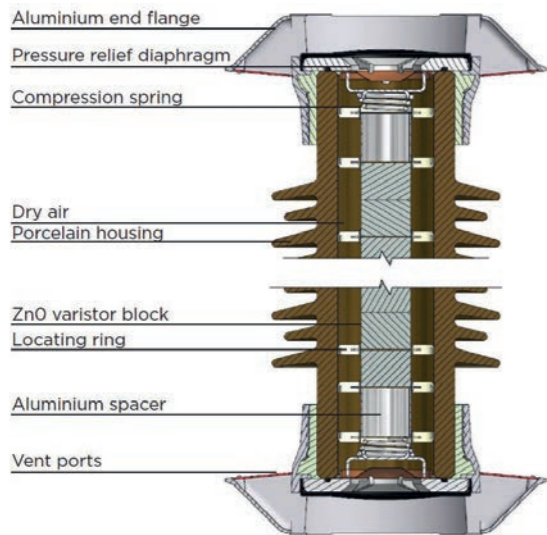

Electrical characteristics

Maximum System Voltage U_m	Rated voltage U_r	Continuous operating voltage U_c	Max. Ures tested with current wave								Steep lightning current impulse (1/20 μ s)			
			Switching current impulse (30/60 μ s)				Lightning current impulse (8/20 μ s)				10 kA	20 kA		
			250 A	500 A	1000 A	2000 A	5 kA	10 kA	20 kA	40 kA	10 kA	20 kA		
kV	kV	kV	kV	kV	kV	kV	kV	kV	kV	kV	kV	kV	kV	kV
12	9	7.2	22.8	23.4	24.2	25.1	27.1	28.5	30.8	34.2	29.9	-		
	12	9.6	23.0	23.6	24.5	25.4	27.4	8.8	31.1	34.6	30.2	-		
	15	12.0	34.2	35.0	36.3	37.7	40.6	42.7	46.1	51.2	44.8	-		
24	18	14.4	34.6	35.4	36.7	38.1	41.0	43.2	46.7	51.8	45.4	-		
	21	16.8	45.6	46.7	48.5	50.3	54.2	57.0	61.6	68.4	59.9	-		
	24	19.2	46.1	47.2	50.8	52.4	54.7	57.6	62.2	69.1	60.5	-		
	27	21.6	57.4	58.9	61.0	63.3	68.2	71.8	77.5	86.2	75.4	-		
36	30	24.0	57.6	59.0	61.2	63.5	68.4	72.0	77.8	86.4	75.6	-		
	36	28.8	69.1	70.8	73.4	76.2	82.1	86.4	93.3	104	90.7	-		
	42	33.6	80.6	82.7	85.7	88.9	95.8	101	109	121	106	-		
	45	36.0	92.0	94.3	97.8	101	109	115	124	138	121	-		
52	54	43.2	104	106	110	114	123	130	140	156	136	-		
	42	33.6	80.6	82.7	85.7	88.9	95.8	101	109	121	106	-		
	45	36.0	92.0	94.3	97.8	101	109	115	124	138	121	-		
	48	38.4	92.2	94.5	97.9	102	109	115	124	138	121	-		
72.5	54	43.2	104	106	110	114	123	130	140	156	136	-		
	60	48.0	115	118	122	127	137	144	156	173	151	-		
	72	57.6	138	142	147	152	164	173	187	207	181	-		
	75	60.0	150	153	159	165	178	187	202	224	196	-		
123	84	67.2	161	165	171	178	192	202	217	242	212	-		
	90	72.0	173	177	184	191	205	216	233	259	227	-		
	96	76.8	184	189	196	203	219	230	249	276	242	-		
	108	86.4	207	213	220	229	246	259	280	311	272	-		
145	120	96.0	230	236	245	254	274	288	311	346	302	-		
	132	106	253	260	269	279	301	317	342	380	333	-		
	138	110	265	272	282	292	315	331	358	397	348	-		
	144	115	276	283	294	305	328	346	373	415	363	-		
	108	86.4	201	207	214	222	236	248	268	293	-	293		
	120	96.0	224	230	237	246	262	276	298	326	-	326		
	132	106	246	253	261	271	288	304	328	358	-	358		
	138	110	257	264	273	283	302	317	343	375	-	375		
	144	115	268	276	285	296	315	331	358	391	-	391		
	30	24.0	57.6	59.0	61.2	63.5	68.4	72.0	77.8	86.4	75.6	-		
	170	138	110	265	272	282	292	315	331	358	397	348	-	
		144	115	276	283	294	305	328	346	373	415	363	-	
150		120	288	295	306	318	342	360	389	432	378	-		
168		134	323	331	343	356	383	403	435	484	423	-		
138		110	257	264	273	283	302	317	343	375	-	375		
144		115	268	276	285	296	315	331	358	391	-	391		
150		120	279	284	297	308	328	345	373	407	-	407		
168		134	313	322	332	345	367	386	417	456	-	456		

Surge arresters with other characteristics are available on request

Mechanical characteristics

TOV Capability (with With prior energy)		Creepage length	Overall height	Minimum distance between phase centres	Minimum distance between phase to earth	Cantilever load		Weight	Drawing Reference	Product code
1 sec* Tr	10 sec* Tr					Specified short-term load (SSL)	Specified long-term load (SLL)			
kV	kV	mm	mm	mm	mm	Nm	kNm	kV	kg	M7
9.9	9.4	540	496	446	60	12.5	5.0	34.0	BOW-14-008	MCA0-9
13.2	12.5	540	496	446	60	12.5	5.0	34.0	BOW-14-008	MCA0-12
16.5	15.6	540	496	476	90	12.5	5.0	34.0	BOW-14-008	MCA0-15
19.8	18.7	1150	666	476	90	12.5	5.0	42.0	BOW-14-009	MCA1-18
23.1	21.8	1150	666	506	120	12.5	5.0	42.0	BOW-14-009	MCA1-21
26.4	25.0	1150	666	506	120	12.5	5.0	42.0	BOW-14-009	MCA1-24
29.7	28.1	1150	666	546	160	12.5	5.0	42.0	BOW-14-009	MCA1-27
33.0	31.2	1150	666	546	160	12.5	5.0	42.0	BOW-14-009	MCA1-30
33.0	31.2	1150	666	546	160	12.5	5.0	42.0	BOW-14-009	MCA1-30
39.6	37.4	1150	666	606	220	12.5	5.0	42.0	BOW-14-009	MCA1-36
46.2	43.7	2390	1036	656	270	12.5	5.0	55.0	BOW-14-010	MCA2-42
49.5	46.8	2390	1036	706	320	12.5	5.0	55.0	BOW-14-010	MCA2-45
59.4	56.2	2390	1036	706	320	12.5	5.0	55.0	BOW-14-010	MCA2-54
46.2	43.7	2390	1036	656	270	12.5	5.0	55.0	BOW-14-010	MCA2-42
49.5	46.8	2390	1036	706	320	12.5	5.0	55.0	BOW-14-010	MCA2-45
52.8	49.9	2390	1036	706	320	12.5	5.0	55.0	BOW-14-010	MCA2-48
59.4	56.2	2390	1036	706	320	12.5	5.0	55.0	BOW-14-010	MCA2-54
59.4	56.2	2390	1036	706	320	12.5	5.0	55.0	BOW-14-010	MCA2-54
66.0	62.4	2390	1036	866	480	12.5	5.0	55.0	BOW-14-010	MCA2-60
79.2	74.9	2390	1036	866	480	12.5	5.0	55.0	BOW-14-010	MCA2-72
82.5	78.0	2390	1036	866	480	12.5	5.0	55.0	BOW-14-010	MCA2-75
92.4	87.4	3820	1384	1016	630	12.5	5.0	90.0	BOW-14-011	MCA3-84
99.0	93.6	3820	1384	1016	630	12.5	5.0	90.0	BOW-14-011	MCA3-90
106	99.8	3820	1384	1016	630	12.5	5.0	90.0	BOW-14-011	MCA3-96
119	112	3820	1384	1286	900	12.5	5.0	90.0	BOW-14-011	MCA3-108
132	125	3820	1384	1286	900	12.5	5.0	90.0	BOW-14-011	MCA3-120
119	112	3820	1384	1286	900	12.5	5.0	90.0	BOW-14-011	MCA3-108
132	125	3820	1384	1286	900	12.5	5.0	90.0	BOW-14-011	MCA3-120
145	137	5000	1736	1286	900	12.5	5.0	115	BOW-14-012	MCA4-132
152	144	5000	1736	1286	900	12.5	5.0	115	BOW-14-012	MCA4-138
158	150	5000	1736	1286	900	12.5	5.0	115	BOW-14-012	MCA4-144
118	111	3820	1384	1016	630	12.5	5.0	90.0	BOW-14-018	MDA3-108
131	124	3820	1384	1286	900	12.5	5.0	90.0	BOW-14-018	MDA3-120
144	136	5000	1736	1286	900	12.5	5.0	115	BOW-14-019	MDA4-132
150	142	5000	1736	1286	900	12.5	5.0	115	BOW-14-019	MDA4-138
157	148	5000	1736	1286	900	12.5	5.0	115	BOW-14-019	MDA4-144
152	144	5000	1736	1286	900	12.5	5.0	115	BOW-14-012	MCA4-138
158	150	5000	1736	1286	900	12.5	5.0	115	BOW-14-012	MCA4-144
165	156	5000	1736	1486	1100	12.5	5.0	115	BOW-14-012	MCA4-150
185	175	5000	1736	1486	1100	12.5	5.0	115	BOW-14-168	MCA4-168
150	142	5000	1736	1286	900	12.5	5.0	115	BOW-14-019	MDA4-138
157	148	5000	1736	1286	900	12.5	5.0	115	BOW-14-019	MDA4-144
165	155	5000	1736	1286	900	12.5	5.0	115	BOW-14-019	MDA4-150
183	173	5000	1736	1486	1100	12.5	5.0	115	BOW-14-019	MDA4-168

* TOV curves are given on technical data sheets for selected surge arrester (on request)

Electrical characteristics

Maximum System Voltage U _m	Rated voltage U _r	Continuous operating voltage U _c	Max. Ures tested with current wave								Steep lightning current impulse (1/20 μs)	
			Switching current impulse (30/60 μs)				Lightning current impulse (8/20 μs)				10 kA	20 kA
			250 A	500 A	1000 A	2000 A	5 kA	10 kA	20 kA	40 kA	10 kA	20 kA
245	180	144	346	354	367	381	410	432	467	518	454	-
245	192	154	369	378	392	406	438	461	498	553	484	-
245	198	158	380	390	404	419	451	475	513	570	499	-
245	216	173	415	425	441	457	492	518	560	622	544	-
245	180	144	335	345	356	370	393	414	447	489	-	489
245	192	154	358	368	380	394	420	442	477	521	-	521
245	198	158	369	379	392	407	433	455	492	537	-	537
245	216	173	402	414	427	444	472	497	537	586	-	586
300	252	202	484	496	514	533	575	605	653	726	635	-
300	258	206	495	508	526	546	588	619	669	743	650	-
300	264	211	507	520	539	559	602	634	684	760	665	-
300	276	221	530	543	563	584	629	662	715	795	696	-
300	288	230	553	567	588	610	657	691	746	829	726	-
300	300	240	576	590	612	635	684	720	778	864	756	-
300	312	250	599	614	636	660	711	749	809	899	786	-
300	252	202	469	483	498	518	551	580	626	684	-	684
300	258	206	481	494	510	530	564	593	641	700	-	700
300	264	211	492	506	522	542	577	607	656	716	-	716
300	276	221	514	529	546	567	603	635	686	749	-	749
300	288	230	537	552	570	592	629	662	715	782	-	782
300	300	240	559	575	593	616	656	690	745	814	-	814
300	312	250	581	598	617	641	682	718	775	847	-	847
420	312	250	599	614	636	660	711	749	809	899	786	-
420	330	264	634	649	673	699	752	792	855	950	832	-
420	336	269	645	661	685	711	766	806	871	968	847	-
420	342	274	657	673	698	724	780	821	886	985	862	-
420	360	288	691	708	734	762	821	864	933	1037	907	-
420	372	298	714	732	759	787	848	893	964	1071	937	-
420	396	317	760	779	808	838	903	950	1026	1140	998	-
420	312	250	581	598	617	641	682	718	775	847	-	847
420	330	264	615	632	653	678	721	759	820	896	-	896
420	336	269	626	644	665	690	734	773	835	912	-	912
420	342	274	637	655	676	702	747	787	850	928	-	928
420	360	288	671	690	712	739	787	828	894	977	-	977
420	372	298	693	713	736	764	813	856	924	1010	-	1010
420	396	317	738	759	783	813	865	911	984	1075	-	1075
500	396	317	738	759	783	813	865	911	984	1075	-	1075
500	420	336	782	805	831	863	918	966	1043	1140	-	1140
500	444	355	827	851	878	912	972	1021	1103	1205	-	1205
500	468	374	872	897	926	961	1023	1076	1163	1270	-	1270

Surge arresters with other characteristics are available on request

Mechanical characteristics

TOV Capability (with With prior energy)		Creepage length	Overall height	Minimum distance between phase centres	Minimum distance between phase to earth	Cantilever load		Weight	Drawing Reference	Product code
1 sec* Tr	10 sec* Tr					Specified short-term load (SSL)	Specified long-term load (SLL)			
kV	kV	mm	mm	mm	mm	Nm	kNm	kV	kg	M7
198	187	7640	2773	2215	1300	12.5	5.0	180	BOW-14-013	MCA33-180
211	200	7640	2773	2215	1300	12.5	5.0	180	BOW-14-013	MCA33-192
218	206	7640	2773	2215	1300	12.5	5.0	180	BOW-14-013	MCA33-198
238	225	7640	2773	2415	1500	12.5	5.0	180	BOW-14-013	MCA33-216
196	185	7640	2773	2015	1100	12.5	5.0	180	BOW-14-020	MDA33-180
209	198	7640	2773	2215	1300	12.5	5.0	180	BOW-14-020	MDA33-192
216	204	7640	2773	2215	1300	12.5	5.0	180	BOW-14-020	MDA33-198
235	222	7640	2773	2215	1300	12.5	5.0	180	BOW-14-020	MDA33-216
277	262	8820	3125	2900	1700	12.5	5.0	205	BOW-14-013	MCA43-252
284	268	8820	3125	2900	1700	12.5	5.0	205	BOW-14-013	MCA43-258
290	275	8820	3125	2900	1700	12.5	5.0	205	BOW-14-013	MCA43-264
304	287	8820	3125	3100	1900	12.5	5.0	205	BOW-14-013	MCA43-276
317	300	10000	3477	3100	1900	12.5	5.0	230	BOW-14-013	MCA44-288
330	312	10000	3477	4100	1900	12.5	5.0	230	BOW-14-013	MCA44-300
343	324	10000	3477	4100	2100	12.5	5.0	230	BOW-14-013	MCA44-312
275	260	8820	3125	2900	1700	12.5	5.0	205	BOW-14-020	MDA43-252
281	266	8820	3125	2900	1700	12.5	5.0	205	BOW-14-020	MDA43-258
288	272	8820	3125	2900	1700	12.5	5.0	205	BOW-14-020	MDA43-264
301	284	8820	3125	2900	1700	12.5	5.0	205	BOW-14-020	MDA43-276
314	297	10000	3477	3100	1900	12.5	5.0	230	BOW-14-020	MDA44-288
327	309	10000	3477	3100	1900	12.5	5.0	230	BOW-14-020	MDA44-300
340	321	10000	3477	4100	1900	12.5	5.0	230	BOW-14-020	MDA44-312
343	324	11460	4162	4400	2100	12.5	5.0	270	BOW-14-014	MCA333-312
363	343	11460	4162	4400	2100	12.5	5.0	270	BOW-14-014	MCA333-330
370	349	11460	4162	5200	2100	12.5	5.0	270	BOW-14-014	MCA333-336
376	356	11460	4162	5200	2350	12.5	5.0	270	BOW-14-014	MCA333-342
396	374	11460	4162	5200	2350	12.5	5.0	270	BOW-14-014	MCA333-360
409	387	13820	4866	5200	2350	12.5	5.0	320	BOW-14-014	MCA443-372
436	412	13820	4866	5400	2600	12.5	5.0	320	BOW-14-014	MCA443-396
340	321	11460	4162	4400	1900	12.5	5.0	270	BOW-14-021	MDA333-312
360	340	11460	4162	4400	2100	12.5	5.0	270	BOW-14-021	MDA333-330
366	346	11460	4162	4400	2100	12.5	5.0	270	BOW-14-021	MDA333-336
373	352	11460	4162	5200	2350	12.5	5.0	270	BOW-14-021	MDA333-342
392	371	11460	4162	5200	2350	12.5	5.0	270	BOW-14-021	MDA333-360
405	383	13820	4866	5200	2350	12.5	5.0	320	BOW-14-021	MDA443-372
432	408	13820	4866	5400	2600	12.5	5.0	320	BOW-14-021	MDA443-396
432	408	15000	5218	5700	2600	12.5	5.0	345	BOW-14-021	MDA444-396
458	433	15000	5218	5700	2600	12.5	5.0	345	BOW-14-021	MDA444-420
484	457	15000	5218	6000	2850	12.5	5.0	345	BOW-14-021	MDA444-444
510	482	15000	5218	6000	2850	12.5	5.0	345	BOW-14-021	MDA444-468

* TOV curves are given on technical data sheets for selected surge arrester (on request)

Termination options

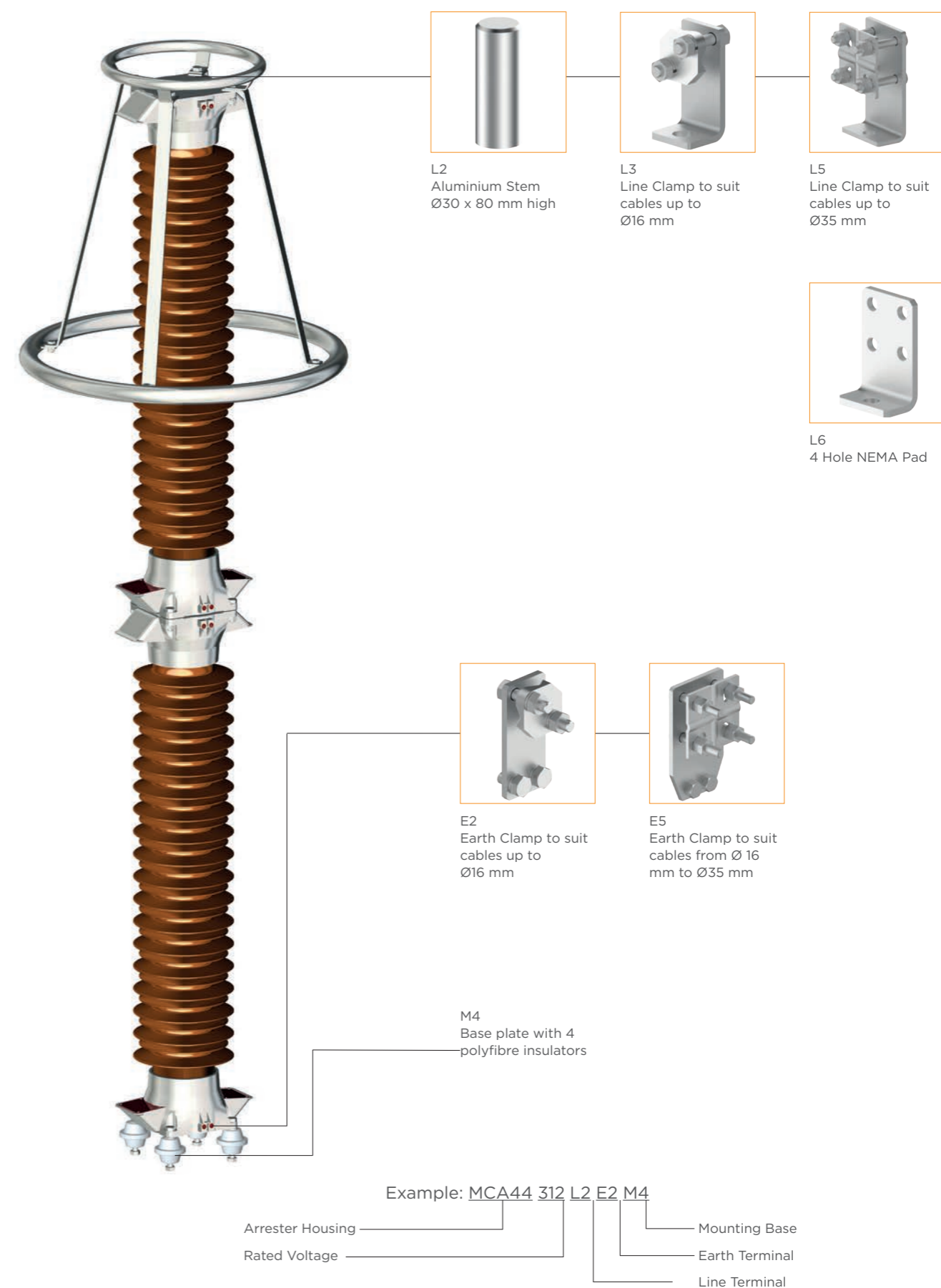

HV Single Column Polymeric Surge Arresters

FEATURES

- Safe non-shattering short circuit behavior to higher current levels
- High-energy handling
- Direct molded housing to prevent moisture ingress
- Hydrophobic and tracking and erosion resistant silicone housing
- High pollution performance
- Extremely strong mechanical strength

APPLICATIONS

- Active overvoltage protection for Substation equipment
- Improves system reliability by reducing downtime caused by overvoltage incidents
- Strong protection for most expensive assets on Substation
- Based on proven technology and more than 40 years of experience in arrester design

BENEFITS

- Light weight for asy installation and product handling
- Capable to withstand seismic conditions
- Maintenance free
- Tested in accordance with IEC60099-4 at independent accredited laboratories
- Quality design and manufacturing, ISO 9001 and 14001 compliant

DESCRIPTION

Decades of design and development experience have been used to produce today's TE Connectivity Single column surge arresters. The construction comprises of a number of ZnO elements, assembled within a open cage construction, which has a silicone rubber moulded shed profile chemically bonded to the surface of the core.

Generic Technical Data

		PAA	PBA	PCA
System Voltage Up to U _{max}	kV	72,5	170	420
System Voltage U _{nom}	kV	66	150	400
Rated discharge current	kA	10	10	10
High current impulse (4/10 μs)	kA	100	100	100
Classification		2	2	3
Energy Capability at U _r	kJ/kV	4,1	6,4	7,8
Short circuit rating	kA	40	65	65
Mechanical strength*				
Safe long-term load (SLL)	kNm	0,25	0,6	2
Safe short-term load (SSL)	kNm	0,35	1	2,5

Electrical Performance

Maximum System Voltage U _m kV	Rated Voltage U _r kV	Line Discharge Class	Long Duration Current 2000 μs	Nominal Discharge Current (8/20 μs) kV	Rated Short Circuit Current kV	Energy Capability at U _r acc. to IEC 60099-4 kV	Arrester Type
12	sept-15	2	500	10	40	4,1	PAA
	sept-15	2	680	10	65	6,4	PBA
	sept-15	3	760	10	65	7,8	PCA
24	18 - 30	2	500	10	40	4,1	PAA
	18 - 30	2	680	10	65	6,4	PBA
	18 - 30	3	760	10	65	7,8	PCA
36	27 - 42	2	500	10	40	4,1	PAA
	27 - 42	2	680	10	65	6,4	PBA
	27 - 42	3	760	10	65	7,8	PCA
72,5	54 - 75	2	500	10	40	4,1	PAA
	54 - 75	2	680	10	65	6,4	PBA
	54 - 75	3	760	10	65	7,8	PCA
123	96 - 120	2	680	10	65	6,4	PBA
	96 - 120	3	760	10	65	7,8	PCA
145	108 - 132	2	680	10	65	6,4	PBA
	108 - 132	3	760	10	65	7,8	PCA
170	138 - 150	2	680	10	65	6,4	PBA
	138 - 150	3	760	10	65	7,8	PCA
245	180 - 216	3	760	10	65	7,8	PCA
300	240 - 288	3	760	10	65	7,8	PCA
400	336 - 360	3	760	10	65	7,8	PCA

Selection information: Dimensions in inches/feet (millimeters/meters)

Electrical characteristics

Maximum System Voltage U _m	Rated voltage U _r	Continuous operating voltage U _c	Max. Ures tested with current wave								Steep lightning current impulse (1/20 μs)	
			Switching current impulse (30/60 μs)				Lightning current impulse (8/20 μs)					
			250 A	500 A	1000 A	2000 A	5 kA	10 kA	15 kA	20 kA		10 kA
kV	kV	kV	kV	kV	kV	kV	kV	kV	kV	kV	kV	kV
170	138	110	276	284	295			335	360	380	396	401
	144	115	288	297	308			350	377	397	414	419
	150	120	297	307	318			361	389	409	428	433
	138	110	272	281	290	303	328	348	369	383	366	
	144	115	284	293	303	317	342	364	385	400	382	
	150	120	296	305	315	330	356	379	401	417	398	
	138	110	265	272	282	292	315	331	348	358	348	
	144	115	276	283	294	305	328	346	363	373	363	
150	120	288	295	306	318	342	360	378	389	378		
245	180	144	346	354	367	381	410	432	454	467	454	
	192	154	369	378	392	406	438	461	484	498	484	
	198	158	380	390	404	419	451	475	499	513	499	
	216	173	415	425	441	457	492	518	544	560	544	
300	252	202	484	496	514	533	575	605	635	653	635	
	258	206	495	508	526	446	588	619	650	669	650	
	264	211	507	520	539	559	602	634	665	684	665	
	276	221	530	543	563	584	629	662	696	715	696	
	288	230	553	567	588	610	657	691	726	746	726	
	300	240	576	590	612	635	684	720	756	778	756	
	312	250	599	614	636	660	711	749	786	809	786	
420	312	250	599	614	636	660	711	749	786	809	786	
	330	264	634	649	673	699	752	792	832	855	832	
	336	269	645	661	685	711	766	806	847	871	832	
	342	274	657	673	698	724	780	821	862	886	862	
	360	288	691	708	734	762	821	864	907	933	907	
	372	298	714	732	759	787	848	893	937	964	937	

Surge arresters with other characteristics are available on request

Mechanical characteristics

TOV Capability (with With prior energy)		Creepage length	Overall height	Minimum distance between phase centres	Minimum distance between phase to earth	Cantilever load		Weight	Drawing Reference	Product code
1 sec* Tr	10 sec* Tr					Specified short-term load (SSL)	Specified long-term load (SLL)			
kV	kV	mm	mm	mm	mm	Nm	kNm	kV	kg	M7
156	150	4500	1216	969	900	0.60	0.50	18.0	BOW-34-082	PAA44-138
162	156	4500	1216	969	900	0.60	0.50	18.0	BOW-34-082	PAA44-144
169	163	4500	1216	969	900	0.60	0.50	18.0	BOW-34-082	PAA44-150
157	150	5212	1685	1178	1100	1.0	0.6	26.5	BOW-33-053	PBA31-138
164	157	5212	1685	1178	1100	1.0	0.6	26.5	BOW-33-053	PBA31-144
171	164	5212	1685	1810	1100	1.0	0.6	26.5	BOW-33-053	PBA31-150
159	150	5600	1571	1810	900	2.5	2.0	38.5	BOW-28-193	PCA31E-138
166	157	5600	1571	1810	900	2.5	2.0	38.5	BOW-28-193	PCA31E-144
173	164	5600	1571	1810	1100	2.5	2.0	38.5	BOW-28-193	PCA31E-150
207	196	9000	2256	2010	1300	2.5	2.0	56.0	BOW-28-193	PCA33E-180
221	209	9000	2256	2010	1300	2.5	2.0	56.0	BOW-28-193	PCA33E-192
228	216	9000	2256	2010	1300	2.5	2.0	56.0	BOW-28-193	PCA33E-198
248	235	9000	2256	2415	1500	2.5	2.0	56.0	BOW-28-193	PCA33E-216
290	275	10100	2796	2900	1700	2.5	2.0	67.0	BOW-28-194	PCA331E-252
297	281	10100	2796	2900	1700	2.5	2.0	67.0	BOW-28-194	PCA331E-258
304	288	10100	2796	3100	1700	2.5	2.0	67.0	BOW-28-194	PCA331E-264
317	301	10100	2796	3100	1900	2.5	2.0	67.0	BOW-28-194	PCA331E-276
331	314	11250	2986	4100	1900	2.5	2.0	71.0	BOW-28-194	PCA332E-288
345	327	13500	3481	4100	1900	2.5	2.0	83.5	BOW-28-194	PCA333E-300
359	340	13500	3481	5200	2100	2.5	2.0	83.5	BOW-28-194	PCA333E-312
359	340	13500	3481	5200	2100	2.5	2.0	83.5	BOW-28-194	PCA332E-312
380	360	13500	3481	5200	2100	2.5	2.0	83.5	BOW-28-194	PCA333E-330
386	366	13500	3481	5200	2100	2.5	2.0	83.5	BOW-28-194	PCA333E-336
393	373	13500	3481	5200	2350	2.5	2.0	83.5	BOW-28-194	PCA333E-342
414	392	13500	3481	5200	2350	2.5	2.0	83.5	BOW-28-194	PCA333E-360
428	405	13500	3481	5200	2350	2.5	2.0	83.5	BOW-28-194	PCA333E-372

* TOV curves are given on technical data sheets for selected surge arrester (on request)

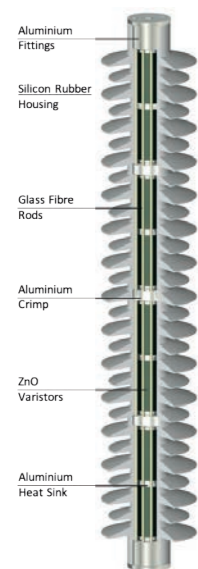

PAA termination options

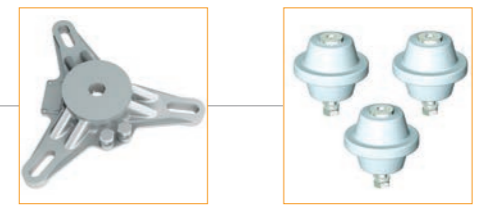
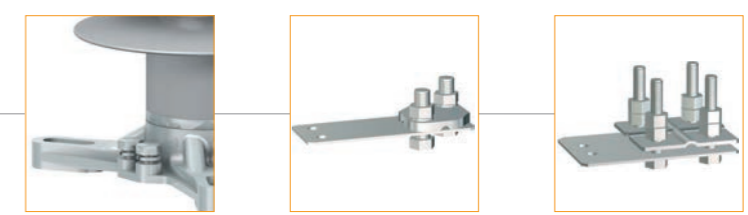

Example: PAA44 96 LO E1 M7



HV Transmission Line Surge Arresters (TLA)

FEATURES

- Safe non-shattering short circuit behavior to higher current levels
- High-energy handling
- Direct molded housing to prevent moisture ingress
- Hydrophobic and tracking and erosion resistant silicone housing
- High pollution performance
- Extremely strong mechanical strength

APPLICATIONS

- Installing transmission line surge arresters on a standard 3 phase voltage system along the line at calculated intervals, allows for optimum performance of the transmission line surge arrester, thus giving increased system line voltage
- This eliminates the need to increase the standard insulation level required on conventional system upgrade (typically requires a full system study)
- TLA suspended from a transmission line giving enhanced transmission line performance
- TLA installed on the tower depending on geometry and clearance

BENEFITS

- Light weight for easy installation and product handling
- Minimizing circuit breaker operation with possible system outage, resulting from back flashover on the shielded transmission line
- Lightning overvoltages are absorbed over the length of the line, thus reducing the severity of surge at the substation
- Transmission systems can be operated even where sub-soil gives poor tower footing resistance
- Eliminating interrupted power supply for sensitive industrial processes
- Tested in accordance with IEC60099-4 at independent accredited laboratories
- Quality design and manufacturing, ISO 9001 and 14001 compliant

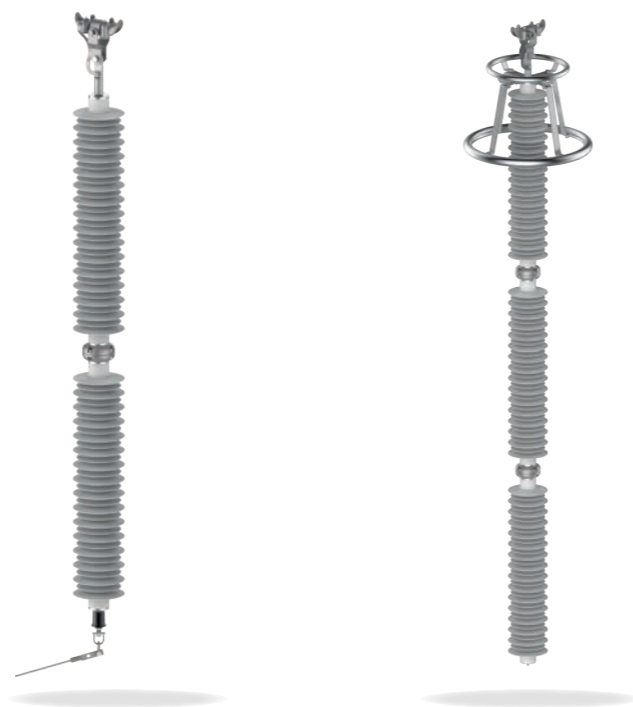
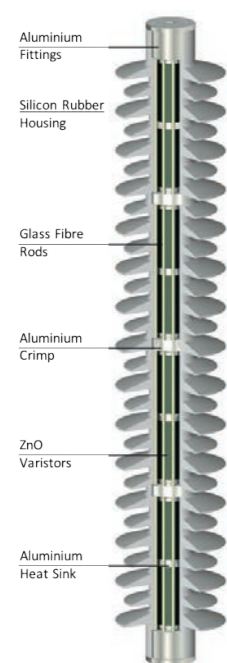

Generic Technical Data

		PAA	PBA	PCA
System Voltage Up to U_{max}	kV	72,5	170	420
System Voltage U_{nom}	kV	66	150	400
Rated discharge current	kA	10	10	10
High current impulse (4/10 μ s)	kA	100	100	100
Classification	-	2	2	3
Energy Capability at U_r	kJ/kV	4,1	6,4	7,8
Short circuit rating	kA	40	65	65
Mechanical strength*	-	-	-	-
Safe long-term load (SLL)	kNm	0,25	0,6	2
Safe short-term load (SSL)	kNm	0,35	1	2,5
Specified short-term load (SSL)	kNm	12,5	12,5	-

Electrical Performance

Maximum system voltage U_m (kV)	Rated voltage U_r (kV)	Arrester designation class	"Long duration current (2000 μ s) (A)"	Nominal discharge current (8/20 μ s) (kA)	Rated short circuit current (kA)	Rated thermal energy capability (W) th (kJ/kV)	Arrester type
24	18 - 30	SL	500	10	40	4,5	TLPAA
	18 - 30	SL	680	10	65	6,4	TLPBA
	18 - 30	SM	760	10	65	7,8	TLPCA
36	27 - 54	SL	500	10	40	4,5	TLPAA
	27 - 54	SL	680	10	65	6,4	TLPBA
	27 - 54	SM	760	10	65	7,8	TLPCA
52	42 - 54	SL	500	10	40	4,5	TLPAA
	42 - 54	SL	680	10	65	6,4	TLPBA
	42 - 54	SM	760	10	65	7,8	TLPCA
72,5	60 - 75	SL	500	10	40	4,5	TLPAA
	60 - 75	SL	680	10	65	6,4	TLPBA
	60 - 75	SM	760	10	65	7,8	TLPCA
123	96 - 120	SL	500	10	40	4,5	TLPAA
	96 - 120	SL	680	10	65	6,4	TLPBA
	96 - 120	SM	760	10	65	7,8	TLPCA
145	108 - 144	SL	500	10	40	4,5	TLPAA
	108 - 144	SL	680	10	65	6,4	TLPBA
	108 - 144	SM	760	10	65	7,8	TLPCA
170	138 - 150	SL	500	10	40	4,5	TLPAA
	138 - 150	SL	680	10	65	6,4	TLPBA
	138 - 150	SM	760	10	65	7,8	TLPCA
245	180 - 228	SL	500	10	40	4,5	TLPAA
	180 - 228	SL	680	10	65	6,4	TLPBA
	180 - 228	SM	760	10	65	7,8	TLPCA
300	240 - 312	SL	680	10	65	6,4	TLPBA
	240 - 312	SM	760	10	65	7,8	TLPCA
420	312 - 372	SM	760	10	65	7,8	TLPCA
500	396 - 468	SM	760	10	65	7,8	TLPCA

Line and Earth configurations

Clamp	Drawing Reference	Conductor Range Dia.	Palm	"U" Bolt Torque
L1	BOW-30-023	-	-	-
L2	BOW-30-028	9.5 -19 mm	L1	45 Nm
L3		18 - 30 mm	L1	45 Nm
L4		30 - 45 mm	L6	75 Nm
L5		45 - 65 mm	L6	75 Nm
L6	BOW-30-024	-	-	-

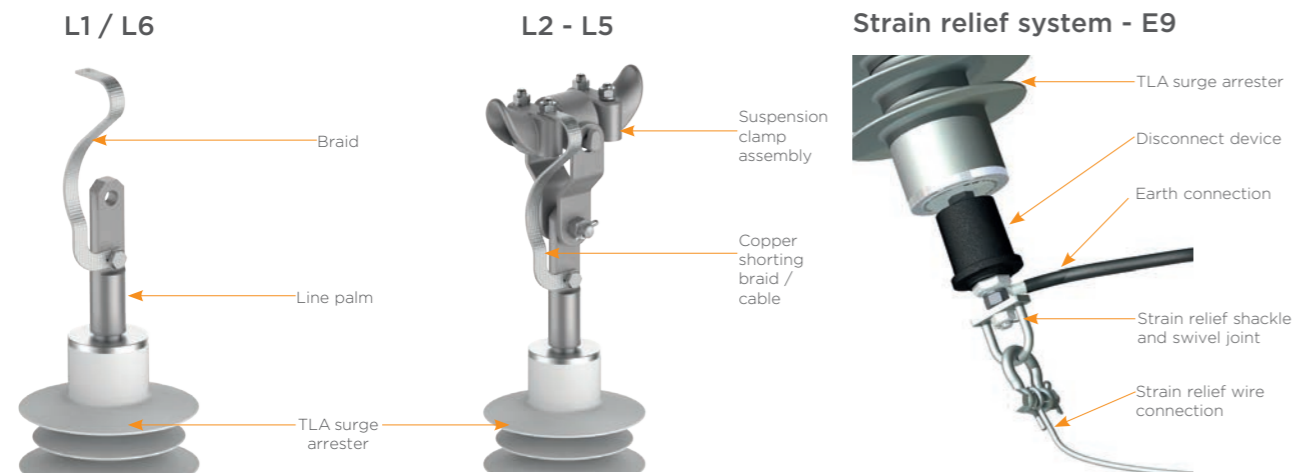

Time vs current curve for DD5 disconnect device

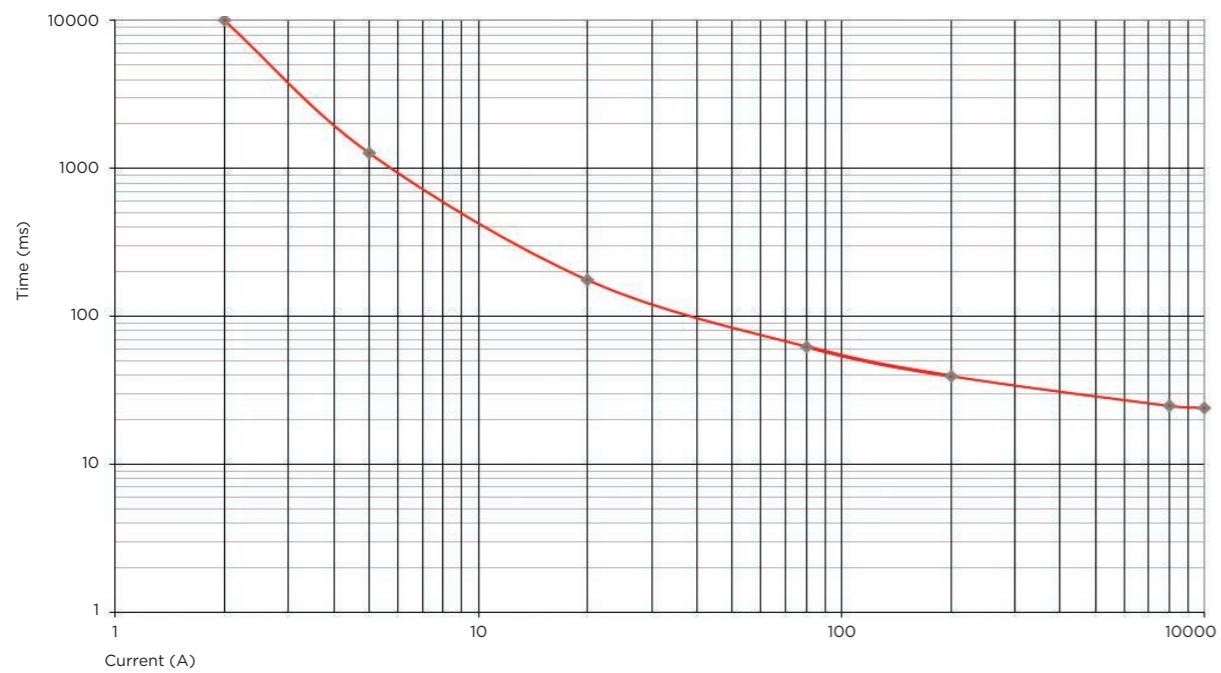



Chapter VIII Crompton Instruments



Integra Multi-function Metering Systems

- Integra range of multi-function metering systems measure, display and communicate over 100 parameters. Integra systems can be integrated into energy management and SCADA systems. Options include pulsed, analogue and RS485 communication protocols, a choice of DIN, DIN-rail and ANSI case-styles and LED or LCD displays.



Integra and Paladin Transducers

- Extensive range of transducers providing measurement, isolation and conversion of electrical parameters into industry standard DC output signals, offering single or multiple analogue outputs within a single case housing.



Energy Meters

- DIN-rail mounted or self-contained panel meters measure combined kWh or kVAh with pulsed or analogue output options and selectable CT and VT ratios. Microprocessor controlled circuitry provides up to Class 1.0 accuracy with outputs displayed directly on the instrument monitor or a remote PC.



Protector Trip Relays

- Trip relays continuously monitor and protect any electrical parameter within a set point limit. The range offers single and multi parameter units, earth leakage protection, ground fault relays, vector shift and ROCOF.



Analogue Instruments

- Traditional range of analogue instruments includes ANSI switchboard meters, panel indicators, sealed and ruggedized instruments, and complementary selector switches for line-to-line and line-to-neutral readings. All instruments are available in a range of styles, sizes and performance specifications.



Current Transformers

- Extensive range of current transformers for reducing high primary currents down to a consistent 5 or 1 Amp secondary current. Options include moulded case width, busbar and aperture sizes, tape wound, 3-in-1, balanced and split cores, current ratings and various mounting options.



Meter Relays and Digital Indicators

- Meter relays and digital indicators are ideal for monitoring, process control and load shedding applications. This range includes digital and analogue meter relays, digital bargraph indicators and controllers.

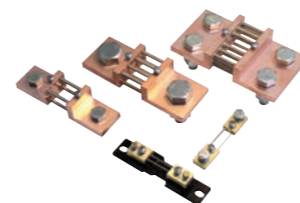

Shunts

- Shunts provides an accurate dc millivolt signal, exactly proportional to the system current, to drive ammeter indicators, overload protection and control devices. This range includes industrial, switchboard, DEF 66-13, DIN base mounted, tag end, lightweight and panel meter shunts in a variety of formats and configurations.

LEARN MORE ABOUT OUR PORTFOLIO AT: TE.COM/CROMPTON-INSTRUMENTS



TE Connectivity is a global industrial technology leader creating a safer, sustainable, productive and connected future. Our broad range of connectivity and sensor solutions, proven in the harshest environments, enable advancements in transportation, industrial applications, medical technology, energy, data communications and the home. With approximately 80,000 employees, including more than 7,500 engineers, working alongside customers in approximately 140 countries, TE ensures that EVERY CONNECTION COUNTS.

Learn more: [TE.com/energy](https://www.te.com/energy)

Connect with us: [TE.com/energy-contact](https://www.te.com/energy-contact)

© 2021 TE Connectivity. All Rights Reserved. GN-CAT-2255-PRODUCTCATALOG-03-21-EN

TE, TE Connectivity, TE connectivity (logo), EVERY CONNECTION COUNTS, AMP, Bowthorpe EMP, Crompton Instruments, GelCap, GelWrap, PowerGel, Raychem, RayGel, Rayvolve, SIMEL are trademarks owned or licensed by TE Connectivity. Other logos, product and company names mentioned herein may be trademarks of their respective owners. While TE has made every reasonable effort to ensure the accuracy of the information in this brochure, TE does not guarantee that it is error-free, nor does TE make any other representation, warranty or guarantee that the information is accurate, correct, reliable or current. TE reserves the right to make any adjustments to the information contained herein at any time without notice. TE Connectivity's obligations shall only be as set forth in TE Connectivity's Standard Terms and Conditions of Sale for this product and in no case will TE Connectivity be liable for any incidental, indirect or consequential damages arising out of the sale, resale, use or misuse of the product. TE expressly disclaims all implied warranties regarding the information contained herein, including, but not limited to, any implied warranties of merchantability or fitness for a particular purpose. The dimensions, specifications, and/or information contained herein are for reference purposes only and are subject to change without notice. Consult TE for the latest dimensions, specifications, and/or information. Users of TE Connectivity products should make their own evaluation to determine the suitability of each such product for the specific application.