

INTERNAL CABLED INTERCONNECT SOLUTIONS

Connectors and Cable Assemblies

Due to the latest high speed demands in networking equipment, TE Connectivity (TE) has developed one of the most flexible and highest performing internal cabled and card edge interconnect portfolios in the market. Our extensive portfolio consists of Sliver products (including versions for SFF-TA-1002), SlimSAS products, SlimSAS Low Profile (LP) products and Mini Cool Edge IO (MCIO) products. These connectors and cable assemblies can be used across many applications, data rates and protocols including PCI Express, SAS and Ethernet.

This new technology simplifies design and helps lower overall costs by eliminating the need for re-timers and more costly lower-loss PCB materials while reaching speeds up to 56 Gbps with the use of TE high speed cable.

Markets

- Data Center & Networking Equipment
 - Servers
 - Switches
 - Routers
 - High Performance Computing (HPC)
 - Storage Devices
 - Wireless Base Stations and Radios

Applications

- Internal Cabled Solutions
 - Chip to Chip
 - Chip to I/O
 - Chip to Backplane
 - Board to Board
- PCB Card Edge (BTB) Solutions
- Supports Ethernet, PCIe, SAS, SATA, InfiniBand and Other Custom Protocols

Sliver Interconnects for SFF-TA-1002

Ultimate flexibility in applications, data rates and protocols

Vertical and right angle connector and cable solutions provide a flexible solution set in addition to allowing for both cabled and card edge interconnect designs.

With a flexible pinout arrangement, multiple mounting and mating options and the support of present and future data rate protocols, the Sliver interconnect solution provides a variety of configuration options to address your application needs.

Free up design space

The 0.6mm contact pitch is up to 30% denser than most existing solutions, allowing you to fit more inside the box.

Reliable connections

The Sliver interconnect solution provides a robust connector housing design while an active latch provides additional connection security for data critical applications.

Lower design costs

Sliver connector and cable assemblies can lower overall costs by eliminating the need for re-timers and more costly lower loss PCB materials.

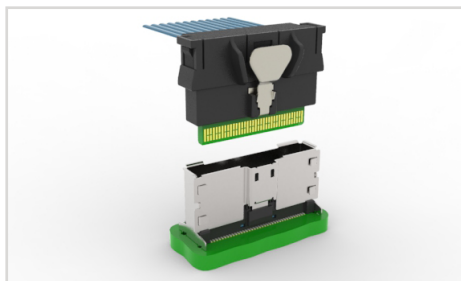
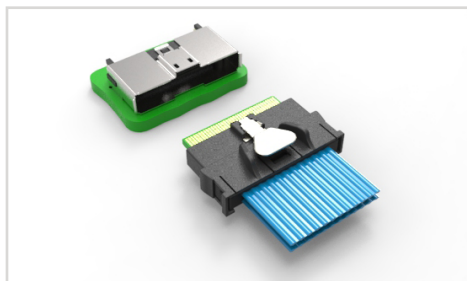

Application Design Flexibility

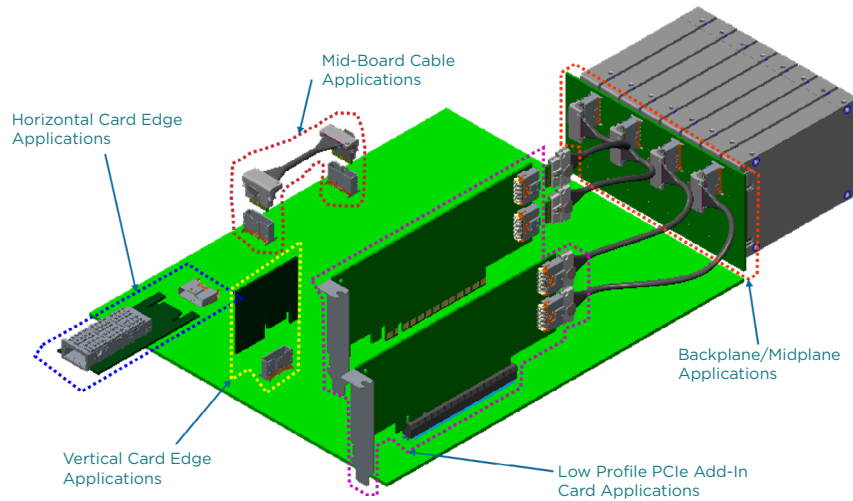

TE's Sliver Interconnect Solution Consists of:

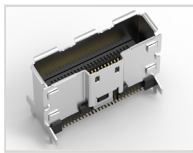

Vertical Board Mount Connector

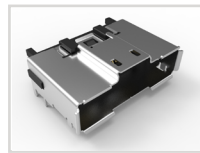

Right Angle Board Mount Connector

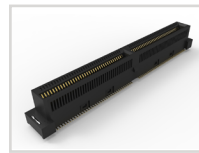

Card Edge Connector



Straddle Mount Connector

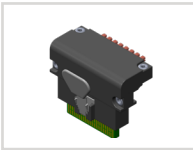

Right Angle Cable Plug Connector

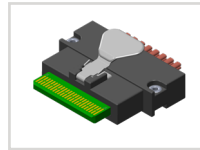

Straight Cable Plug Connector

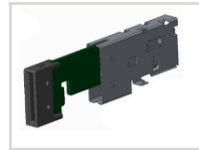

Orthogonal Connector

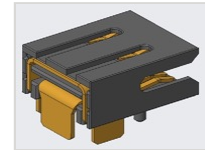

Right Angle Power Module

Key Features

- 0.6mm pitch SMT connector design includes robust metal housing
- 25G and 32G high speed, low-loss 30/33AWG cable
- Vertical, right angle, lateral and card edge configurations with active latch
- Supports 85 and 100 ohm impedance applications
- Flexible pinout arrangement allows for mix of differential signal pairs and low speed single-ended sidebands
- Flexible mounting and mating arrangements:
 - Cabled interconnects
 - Card edge interconnects
 - Vertical to right-angle, vertical to straight, right-angle to right-angle, and right-angle to straight receptacle-to-plug mating
- Platform developed to be scalable in x4/x8 increments
 - Sliver: 50p (x8), 74p (x12), 124p (x20)
 - Sliver for SFF-TA-1002: 28p (x4), 56p (x4), 84p (x8), 140p (x16), 168p(x16+)
- Supports present and future bandwidth needs without requiring requalification and redesign

Part Number Details

Connectors

Part Description	TE Part Numbers		
	50 Position	74 Position	124 Position
Vertical PCB Connector	2292096-1	2324787-1	TBD
Right Angle PCB Connector	2292055-1	2292069-1	2323321-1
	148 Position	-	-
Vertical PCB Card Edge Connector	2297117-2	-	-
Right Angle PCB Card Edge Connector	2331498-1	-	-

Plug Kits

Part Description	TE Part Numbers		
	50 Position	74 Position	124 Position
Straight Plug Kit	2317815-1	2317823-1	2339107-1

Cable Assemblies

Part Description	Data Rate	Impedance	Bulk Cable	TE Part Numbers					
				50 Position		74 Position		124 Position	
				0.5 Meter	1 Meter	0.5 Meter	1 Meter	0.5 Meter	1 Meter
Straight Cable Plug	25G	85	Discrete Pairs	2821742-1	2821742-2	2821376-1	2821376-2	-	-
Right Angle Plug	25G	85	Discrete Pairs	2821743-1	2821743-2	2821745-1	2821745-2	-	-
Straight-Right Angle Plugs	25G	85	Discrete Pairs	2821744-1	2821744-2	2821746-1	2821746-2	-	-
Straight Cable Plug	25G	100	Discrete Pairs	2821750-1	2821750-2	2821756-1	2821756-2	-	-
Right Angle Plug	25G	100	Discrete Pairs	2821751-1	2821751-2	2821757-1	2821757-2	-	-
Straight-Right Angle Plugs	25G	100	Discrete Pairs	2821752-1	2821752-2	2821758-1	2821758-2	-	-
Straight Cable Plug	12G	85	Ribbon	2820397-1	2820397-2	2820396-1	2820396-2	-	-
Right Angle Plug	12G	85	Ribbon	2820399-1	2820399-2	2821385-1	2821385-2	-	-
Straight-Right Angle Plugs*	12G	85	Ribbon	2821638-1	2821638-2	2821639-1	2821639-2	-	-
Straight Cable Plug	12G	100	Ribbon	2821747-1	2821747-2	2821753-1	2821753-2	-	-
Right Angle Plug	12G	100	Ribbon	2821748-1	2821748-2	2821754-1	2821754-2	-	-
Straight-Right Angle Plugs	12G	100	Ribbon	2821749-1	2821749-2	2821755-1	2821755-2	-	-
Straight Cable Plug	12G	85	Discrete Pairs	-	-	-	-	2324305-1	2324305-2

Contact your TE representative about custom cable assembly configurations.

Sliver Interconnects for SFF-TA-1002

The SFF-TA-1002 standard defines vertical, right angle, straddle mount and orthogonal connectors for servers and storage devices and has been adopted by several industry standards groups including COBO, Gen-Z, EDSFF and the Open Compute Project (OCP).

Highest performing card edge connector for SFF-TA-1002

Our Sliver connectors have been adopted as the standard into SFF-TA-1002. The SFF-TA-1002 pinout supports EDSFF, PCIe, OCP NIC and other standards.

Cable assemblies with push button and pull tab features

Sliver cable assemblies with push button and pull tab features can be connected with SFF-TA-1002 receptacles. The pull tab cable assemblies are able to easily unlatch plugs from receptacles in high-speed cabled interconnects applications where there is not enough space to allow a finger in. They are interoperable with SFF-TA-1002 standard receptacles and can meet PCIe Gen 5 signal integrity requirement. These products are available in straight and right angle mating options.

Standardized designs

Enable easy design in and multi-sourcing by consolidating fragmented pinouts and speeds.

Supports high speed and density for next-generation silicon

Sliver connectors for SFF-TA-1002 support high speeds through PCIe Gen 5, with a roadmap to PCIe Gen 6, PCIe Gen 7/ 128Gbps. They also support next-generation silicon PCIe lane counts where current products begin to max out.

Sliver Power Module

The Sliver power module can be used with any SFF-TA-1002 vertical connector. This follows the same interface as EDSFF and can be used with a card edge or cable receptacle.

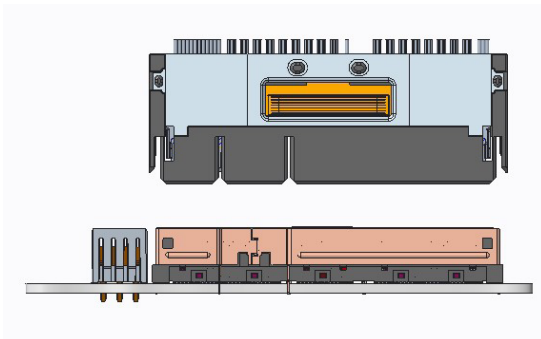

Sliver Power Module shown with Cabled Receptacle

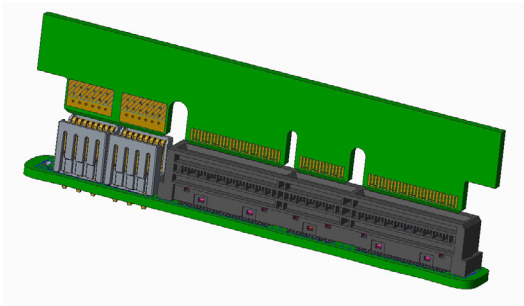

Sliver Power Module shown with Card Edge

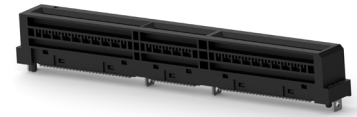

Sliver for SFF-TA-1002
Vertical Connector

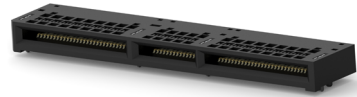

Sliver for SFF-TA-1002
Right Angle Connector

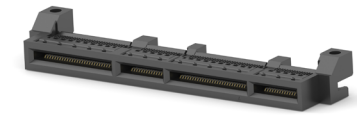

Sliver for SFF-TA-1002
Straddle Mount Connector

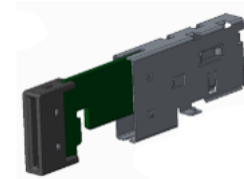

Sliver for SFF-TA-1002
Orthogonal Connector



Sliver Pull Tab Cable
Assembly for SFF-TA-1002
Receptacle

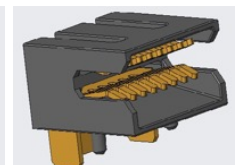
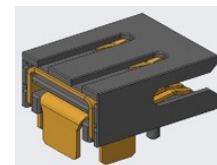

Right Angle Power Module

Part Number Details

Card Edge Receptacles

Part Description	Orientation	Standard	TE Part Numbers					
			56 Position	84 Position	140 Position	168 Position	196 Position	280 Position
Card Edge Receptacle	Vertical	SFF-TA-1002	2327679-1	2327678-1	2327677-1	-	-	-
Card Edge Receptacle + Power	Vertical	N/A	-	-	2338718-1	-	-	-
Card Edge Receptacle	Vertical	N/A	-	-	-	2333799-1	-	-
Card Edge Receptacle	Vertical	SFF Derivative	-	-	-	-	2375538-1	2338461-1
Card Edge Receptacle	Right Angle	SFF-TA-1002	2327672-1	2327671-1	2327670-1	2336568-1	-	-
Card Edge Receptacle 1x1 SMT	Orthogonal	SFF-TA-1002, EDSFF	2339207-1	2339208	-	-	-	-
Card Edge Receptacle 1x4 SMT	Orthogonal	SFF-TA-1002, EDSFF	2339205-1	2339211-1	-	-	-	-
Card Edge Receptacle 1x1 PF	Orthogonal	SFF-TA-1002, EDSFF	2334227-1	TBD	-	-	-	-
Card Edge Receptacle 1x4 PF	Orthogonal	SFF-TA-1002, EDSFF	2343147-1	TBD	-	-	-	-
Card Edge Receptacle, 1.57mm Host PCB	Straddle	SFF-TA-1002, OCP NIC 3.0	-	2340326-1	2340324-1	2340321-1	-	-
Card Edge Receptacle, 1.57mm Host PCB	Straddle	N/A	2340331-1	-	-	-	-	-
Card Edge Receptacle, 1.93mm Host PCB	Straddle	SFF-TA-1002, OCP NIC 3.0	-	-	1-2340324-2	1-2340321-2	-	-
Card Edge Receptacle, 2.36mm Host PCB	Straddle	SFF-TA-1002, OCP NIC 3.0	-	-	2-2340324-1	2-2340321-1	-	-

Receptacles for Cable Assemblies

Part Description	Orientation	Standard	TE Part Numbers				
			28 Position	56 Position	84 Position	140 Position	168 Position
Receptacle for Cable Assembly	Vertical	SFF-TA-1002	-	2332141-1	2331813-1	2332139-1	2384218-1
Receptacle for Cable Assembly	Right Angle	SFF-TA-1002	-	2332208-1	2331814-1	2332205-1	2369833-1
Receptacle for Cable Assembly	Right Angle	SFF Derivative	2345808-1	-	-	-	-

Card Edge Power

Part Description	Orientation	Standard	TE Part Numbers
50 AMP Card Edge Assembly - Open Wall	Vertical	SFF Derivative	2344604-1
50 AMP Card Edge Assembly	Right Angle	SFF Derivative	2351970-1
50 AMP Card Edge Assembly - One End Wall	Vertical	SFF Derivative	2345506-1
4C High Power Card Edge Assembly	Vertical	SFF Derivative	2338718-1

Sliver Direct to Lead Frame Cable Assemblies

Part Description	Impedance	Wire Size	TE Part Numbers			
			56 Position		168 Position	
			0.5 Meter	1.0 Meter	0.5 Meter	0.3 Meter
4C+ RECEPTACLE ASSEMBLY to 4C+ PLUG	85	30 AWG	-	-	2373783-1	2373783-2
4C+ RECEPTACLE ASSEMBLY to MCIO & SLIVER 1C HYBRID	85	30 AWG	-	-	2421050-x	2421050-x
1C RECEPTACLE ASSEMBLY	85	30 AWG	2373744-1	2343284-2	-	-
1C ORTHOGONAL	85	30 AWG	2428093-1	2428093-x	-	-

Sliver Cable Assemblies

Part Description	Impedance	Wire Size	TE Part Numbers- Push Button Cable Assemblies					
			56 Position		84 Position		140 Position	
			0.5 Meter	1.0 Meter	0.5 Meter	1.0 Meter	0.5 Meter	1.0 Meter
Straight to Straight Cable	85	33 AWG	2340872-1	2340872-2	2340783-1	2340783-2	2340879-1	2340879-2
Straight to R/A Cable	85	33 AWG	2340873-1	2340873-2	2340930-1	2340930-2	2340880-1	2340880-2
R/A to R/A Cable	85	33 AWG	2340874-1	2340874-2	2340789-1	2340789-2	2340881-1	2340881-2
Lateral to Lateral Cable	85	33 AWG	2343284-1	2343284-2	2343286-1	2343286-2	2343288-1	2343288-2
Straight to Straight Cable	85	30 AWG	2340876-1	2340876-2	2340861-1	2340861-2	2340882-1	2340882-2
Straight to R/A Cable	85	30 AWG	2340877-1	2340877-2	2340863-1	2340863-2	2340884-1	2340884-2
R/A to R/A Cable	85	30 AWG	2340878-1	2340878-2	2340865-1	2340865-2	2340885-1	2340885-2
Straight to Straight Cable	100	33 AWG	2349831-1	2349831-2	2349835-1	2349835-2	2349841-1	2349841-2
Straight to R/A Cable	100	33 AWG	2349832-1	2349832-2	2349838-1	2349838-2	2349842-1	2349842-2
R/A to R/A Cable	100	33 AWG	2349833-1	2349833-2	2349839-1	2349839-2	2349843-1	2349843-2
Lateral to Lateral Cable	100	33 AWG	2349834-1	2349834-2	2349840-1	2349840-2	2349844-1	2349844-2

All cable assemblies can be used for SFF-TA-1002 receptacles.

Part Description	Impedance	Wire Size	TE Part Numbers- Pull Tab Cable Assemblies					
			56 Position		84 Position		140 Position	
			0.5 Meter	1.0 Meter	0.5 Meter	1.0 Meter	0.5 Meter	1.0 Meter
Straight to Straight Cable	85	33 AWG	2361330-1	2361330-2	2361341-1	2361341-2	2361352-1	2361352-2
Straight to R/A Cable	85	33 AWG	2361332-1	2361332-2	2361343-1	2361343-2	2361354-1	2361354-2
R/A to R/A Cable	85	33 AWG	2361334-1	2361334-2	2361345-1	2361345-2	2361356-1	2361356-2
Lateral to Lateral Cable	85	33 AWG	2361336-1	2361336-2	2361347-1	2361347-2	2361358-1	2361358-2
Straight to Straight Cable	85	30 AWG	2361331-1	2361331-2	2361342-1	2361342-2	2361353-1	2361353-2
Straight to R/A Cable	85	30 AWG	2361333-1	2361333-2	2361344-1	2361344-2	2361355-1	2361355-2
R/A to R/A Cable	85	30 AWG	2361335-1	2361335-2	2361346-1	2361346-2	2361357-1	2361357-2
Straight to Straight Cable	100	33 AWG	2361337-1	2361337-2	2361348-1	2361348-2	2361359-1	2361359-2
Straight to R/A Cable	100	33 AWG	2361338-1	2361338-2	2361349-1	2361349-2	2361360-1	2361360-2
R/A to R/A Cable	100	33 AWG	2361339-1	2361339-2	2361350-1	2361350-2	2361361-1	2361361-2
Lateral to Lateral Cable	100	33 AWG	2361340-1	2361340-2	2361351-1	2361351-2	2361362-1	2361362-2

All cable assemblies can be used for SFF-TA-1002 receptacles.

SlimSAS, SlimSAS LP and MCIO Interconnects



Support SAS and PCIe Protocols

- SlimSAS and SlimSAS LP solutions provide PCIe Gen 4 cable and connector capability. MCIO connectors can support PCIe Gen 5
- SlimSAS connectors are industry-standard (address SFF8654) products. MCIO and SlimSAS LP products can be sourced from TE or Amphenol

Increase design flexibility

- Can enable building block architectures in system design (can connect different functionality PCBs together)
- Can provide flexibility of where/how to use signals in your system
- Replaces PCB trace and PCB connector interfaces for a higher performing channel
- Straight, right angle and lateral exit cable options available for custom routing
- Full portfolio enables hybrid-style cable assemblies

Save Space

- Low profile connector design can save space
- 0.6mm pitch can balance manufacturability with density
- Multiple cable exits for route-ability

Part Number Details

Receptacles

Size	Product	Orientation	Configuration	Part Number
38P	MCIO	Vertical	X4	2417916-X (85 Ohm)
74P	MCIO	Vertical	X8	2359366-X (92 Ohm)
74P	MCIO	Vertical	X8	2379397-X (85 Ohm)
124P	MCIO	Vertical	X16	2360189-X (92 Ohm)
124P	MCIO	Vertical	X16	2381578-X (85 Ohm)
38P	SlimSAS LP	Vertical	X4	2360221-X (85 Ohm)
74P	SlimSAS LP	Vertical	X8	2359992-X (85 Ohm)
124P	SlimSAS LP	Vertical	X16	2360229-X (85 Ohm)
74P	SlimSAS	Vertical	X8	2356318-X (85 Ohm)
74P	SlimSAS	Vertical	X8	2369938-X (100 Ohm)
74P	SlimSAS	Right Angle	X8	2356320-X (85 Ohm)
74P	SlimSAS	Right Angle	X8	2369956-X (100 Ohm)
38P	SlimSAS	Vertical	X4	2369957-X (100 Ohm)
38P	SlimSAS	Right Angle	X4	2369958-X (100 Ohm)

SlimSAS Internal Cable & Connectors

- 0.6mm pitch
- 22.4mm height (vertical receptacle, right angle plug)
- Center latching
- SFF-8654 compliant
- Connector
 - 85 Ohm, 16G NRZ
 - 100 Ohm, SAS-4
- Cable assembly
 - 100 Ohm: SAS-4
 - 85 Ohm: PCIe gen 4

SlimSAS LP Internal Cable & Connectors

- 0.6mm pitch
- 13.45mm height (vertical receptacle, right angle plug)
- Center latching
- Connector: 85 Ohm, 16G NRZ
- Cable assembly
 - 100 Ohm: SAS-4
 - 85 Ohm: PCIe gen 4

Cable Assemblies

Size	Product	Characteristics	Part Number
74p	MCIO	Straight - Right Angle 85 Ohm, 30 AWG	2366780-1
74p	MCIO	Lateral Left - Lateral Right 85 Ohm, 30 AWG	2366550-1
124p	MCIO	Straight - Right Angle 85 Ohm, 30 AWG	2366783-1
124p	MCIO	Lateral Left - Lateral Right 85 Ohm, 30 AWG	2366557-1
38p	SlimSAS LP	Straight - Right Angle 85 Ohm, 30 AWG	2366789-1
38p	SlimSAS LP	Lateral Left - Lateral Right 85 Ohm, 30 AWG	2366861-1
74p	SlimSAS LP	Straight - Right Angle 85 Ohm, 30 AWG	2366784-1
74p	SlimSAS LP	Lateral Left - Lateral Right 85 Ohm, 30 AWG	2366559-1
124p	SlimSAS LP	Straight - Right Angle 85 Ohm, 30 AWG	2366786-1
124p	SlimSAS LP	Lateral Left - Lateral Right 85 Ohm, 30 AWG	2366598-1
74p	SlimSAS	Straight - Right Angle 85 Ohm, 30 AWG	2366833-1
74p	SlimSAS	Lateral Left - Lateral Right 85 Ohm, 30 AWG	2366835-1

Custom cable assemblies available on demand

Future additions include right angle MCIO and 100 Ohm SlimSAS connectors

MCIO Internal Cable & Connectors

- 0.6mm pitch
- 13.95mm height (vertical receptacle, right angle plug)
- Center latching
- Addresses next gen industry standard: SFF-TA-1016
- Connector
 - 92 Ohm, 32G NRZ, roadmap to 112G PAM-4
 - 85 Ohm +/- 10% version in development
- Cable assembly
 - 100 Ohm: 56G PAM-4, SAS-4
 - 85 Ohm: PCIe gen 4, PCIe gen 5

te.com

TE Connectivity, TE, and TE Connectivity (logo) are trademarks of the TE Connectivity Ltd. family of companies. All other logos, products and/or company names referred to herein might be trademarks of their respective owners.

The information given herein, including drawings, illustrations and schematics which are intended for illustration purposes only, is believed to be reliable. However, TE Connectivity makes no warranties as to its accuracy or completeness and disclaims any liability in connection with its use. TE Connectivity's obligations shall only be as set forth in TE Connectivity's Standard Terms and Conditions of Sale for this product and in no case will TE Connectivity be liable for any incidental, indirect or consequential damages arising out of the sale, resale, use or misuse of the product. Users of TE Connectivity products should make their own evaluation to determine the suitability of each such product for the specific application.

©2022 TE Connectivity Ltd. family of companies. All Rights Reserved.

1-1773871-5 11/22

TE Technical Support Center

USA:	1.800.522.6752
Canada:	1.905.475.6222
Mexico:	52.0.55.1106.0800
Latin/S. America:	54.0.11.4733.2200
Germany:	49.0.6251.133.1999
UK:	44.0.800.267666
France:	33.0.1.3420.8686
Netherlands:	31.0.73.6246.999
China:	86.0.400.820.601