



MS5839-02BA

Ultra-compact, chlorine resistant, digital pressure and temperature sensor

Miniaturization, performance and precision are key for sensors embedded in consumer devices like swim watches and diving equipment. Expanding on TE Connectivity's (TE) portfolio of ultra-compact digital altimeters, our MS5839 2 bar model is designed to meet the next generation of device manufacturer designs and challenges.

TE's MS5839 is an ultra-compact (3.3 x 3.3 x 2.75 mm) digital altimeter that is optimized for applications where chlorine and saline are present. The robust, gel-filled design of the MS5839 enables operation in harsh media environments while providing accurate and reliable digital measurements.

This MEMS based sensor offers advanced water resistance, chlorine resistance, shielding, low power consumption and digital interconnectivity in an ultra-compact, low profile package. The board level design delivers sensing accuracy for both pressure ($\pm 0.5\text{mbar}$) and temperature ($\pm 2^\circ\text{C}$) measurements.

Take your devices to the next level with the MS5839-02BA.

APPLICATIONS

- Shallow Diving Computers
- Swim Watches
- Fitness Trackers
- Underwater Vehicles
- Diving Equipment
- Diving Computers

FEATURES

- Ceramic and metal package: 3.3 x 3.3 x 2.75mm
- High resolution module: 13 cm
- Supply voltage: 1.5 to 3.6 V
- Low power: 0.6 μA (standby $\leq 0.1 \mu\text{A}$ at 25°C)
- Integrated digital pressure sensor (24-bit $\Delta\Sigma$ ADC)
- Operating range: 300 to 1,200 mbar, -20 to $+85^\circ\text{C}$
- I²C interface
- No external components (internal oscillator)
- Water resistant sealing with 1.8 x 0.8mm O-ring
- Chlorine resistant
- Shielded metal lid

MS5839-02BA

Ultra-compact, chlorine resistant, digital pressure and temperature sensor

PERFORMANCE SPECIFICATIONS

ABSOLUTE MAXIMUM RATINGS

Parameter	Symbol	Conditions	Min.	Typ.	Max	Unit
Supply voltage	V _{DD}		-0.3		+3.6	V
Storage temperature	T _S		-40		+85	°C
Overpressure	P _{max}	ISO 22810 ⁽¹⁾			10	bar
Maximum Soldering Temperature ⁽²⁾	T _{max}	40 sec. max			250	°C
ESD rating (lid to GND version)		Human Body Model	-2		+2	kV
Latch up		JEDEC JESD78 standard	-100		+100	mA

⁽¹⁾ Pressure ramp up/down min 60s

⁽²⁾ Refer to application note 808

ELECTRICAL CHARACTERISTICS

Parameter	Symbol	Conditions	Min.	Typ.	Max	Unit
Operating Supply voltage	V _{DD}		1.5	3.0	3.6	V
Operating Temperature	T		-20	+25	+85	°C
Supply current (1 sample per sec.)	I _{DD}	OSR		20.09 10.05 5.02 2.51 1.26 0.63		μA
Peak supply current		during conversion		1.25		mA
Standby supply current		at 25°C (V _{DD} = 3.0 V)		0.01	0.1	μA
Power supply hold off for internal reset ⁽³⁾		V _{DD} < 0.1V	200			ms
VDD Capacitor		from VDD to GND	100	470		nF
Resistor value between the lid and the GND				1000		Ω

⁽³⁾ Supply voltage power up must be continuous from GND to VDD without any step

ANALOG DIGITAL CONVERTER (ADC)

Parameter	Symbol	Conditions	Min.	Typ.	Max	Unit
Output Word				24		bit
ADC Conversion time ⁽⁴⁾	t _c	OSR		16.44 8.22 4.13 2.08 1.06 0.54	17.2 8.61 4.32 2.17 1.10 0.56	ms

⁽⁴⁾ Maximum values must be used to determine waiting times in I²C communication

PERFORMANCE SPECIFICATIONS (Continued)

PRESSURE OUTPUT CHARACTERISTICS ($V_{DD} = 3\text{ V}$, $T = 25^\circ\text{C}$ UNLESS OTHERWISE NOTED)

Parameter	Conditions		Min.	Typ.	Max	Unit
Operating Pressure Range	P_{range}		300		1200	mbar
Extended Pressure Range	P_{ext}	Linear Range of ADC	10		2000	mbar
Relative Accuracy ^{(1) (4)}	600...1000 mbar, at 20°C		-0.5		+0.5	mbar
	300...1100 mbar, $0...60^\circ\text{C}$		-2		+2	
	300...1100 mbar, $-20...85^\circ\text{C}$		-4		+4	
Resolution RMS	OSR	8192		0.016	mbar	
		4096		0.021		
		2048		0.028		
		1024		0.039		
		512		0.062		
		256		0.11		
Maximum error with supply voltage ⁽²⁾	$V_{DD} = 1.5\text{ V}...3.6\text{ V}$			± 2		mbar
Long-term stability				± 1		mbar/yr
Reflow soldering impact	IPC/JEDEC J-STD-020C (Refer to application note AN808)			± 4		mbar
Recovering time after reflow ⁽³⁾				7		days

⁽¹⁾ With autozero at one pressure point⁽²⁾ With autozero at 3V point⁽³⁾ Time to recover at least 66% of reflow impact⁽⁴⁾ Wet/dry cycle: sensor must be dried typically once a dayTEMPERATURE OUTPUT CHARACTERISTICS ($V_{DD} = 3\text{ V}$, $T = 25^\circ\text{C}$ UNLESS OTHERWISE NOTED)

Parameter	Conditions		Min.	Typ.	Max	Unit
Relative Accuracy	$-20...85^\circ\text{C}$, 300...1100 mbar		-2		+2	$^\circ\text{C}$
Maximum error with supply voltage	$V_{DD} = 1.5\text{ V}...3.6\text{ V}$			± 0.3		$^\circ\text{C}$
Resolution RMS	OSR	8192		0.002	$^\circ\text{C}$	
		4096		0.003		
		2048		0.004		
		1024		0.006		
		512		0.009		
		256		0.012		

DIGITAL INPUTS (SDA, SCL)

Parameter	Symbol	Conditions	Min.	Typ.	Max	Unit
Serial data clock	SCL				400	kHz
Input high voltage	V_{IH}		$80\% V_{DD}$		$100\% V_{DD}$	V
Input low voltage	V_{IL}		$0\% V_{DD}$		$20\% V_{DD}$	V
Input leakage current	I_{leak}	$T = 25^\circ\text{C}$			0.1	μA

DIGITAL OUTPUTS (SDA)

Parameter	Symbol	Conditions	Min.	Typ.	Max	Unit
Output high voltage	V_{OH}	$I_{\text{source}} = 1\text{ mA}$	$80\% V_{DD}$		$100\% V_{DD}$	V
Output low voltage	V_{OL}	$I_{\text{sink}} = 1\text{ mA}$	$0\% V_{DD}$		$20\% V_{DD}$	V

TYPICAL PERFORMANCE CHARACTERISTICS

RELATIVE PRESSURE ERROR AND TEMPERATURE ERROR VS PRESSURE AND TEMPERATURE (TYPICAL VALUES)

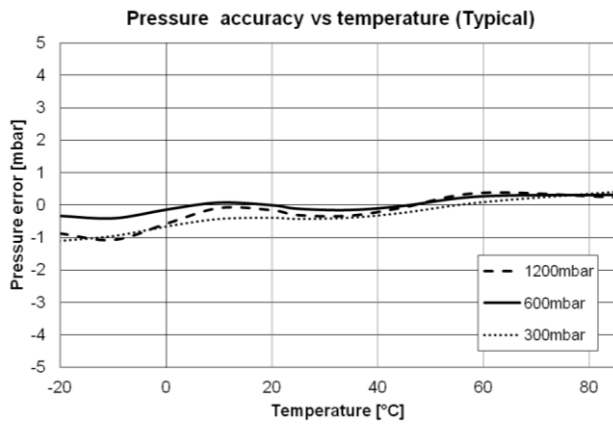
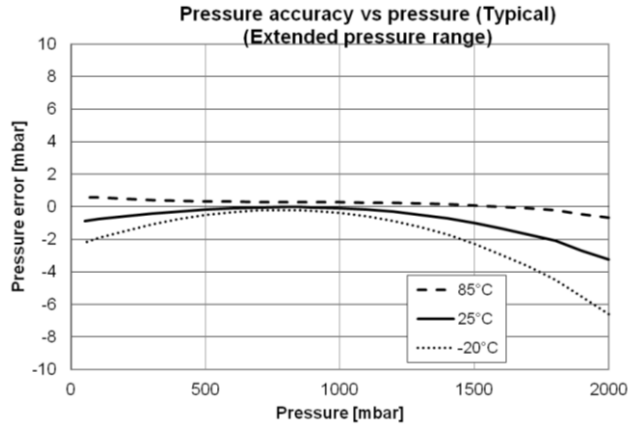
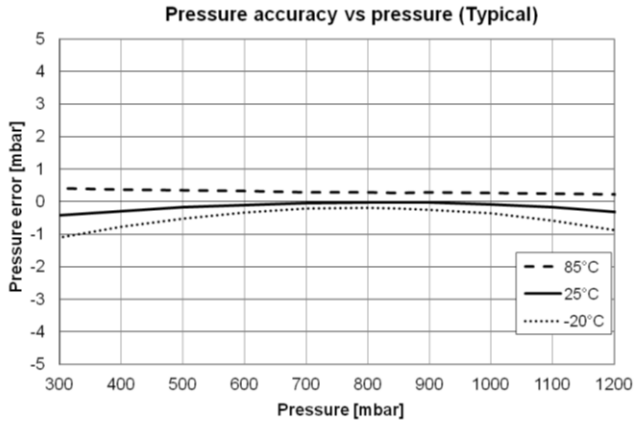

TYPICAL PERFORMANCE CHARACTERISTICS

RELATIVE PRESSURE AND TEMPERATURE ERROR VS TEMPERATURE
(1ST ORDER AND 2ND ORDER ALGORITHM, TYPICAL VALUES)

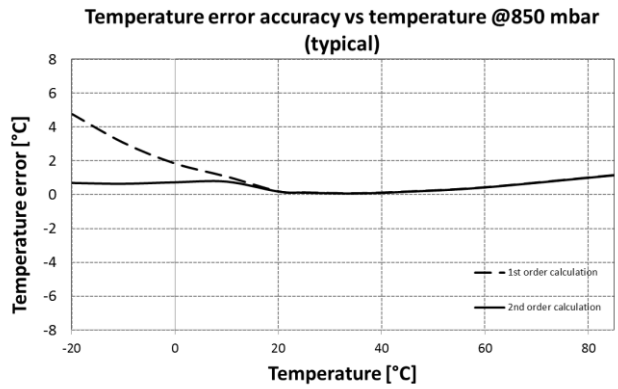
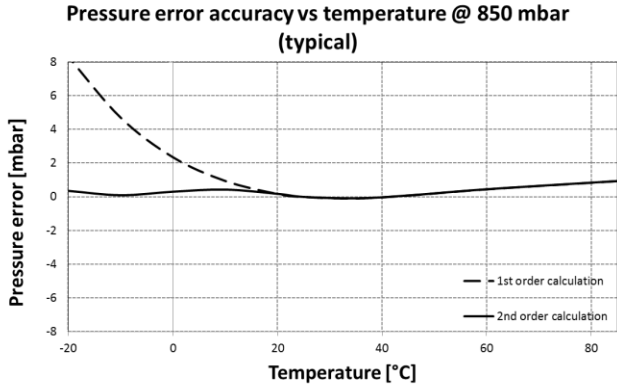

RELATIVE PRESSURE AND TEMPERATURE ERROR VS POWER SUPPLY
(TYPICAL VALUES)

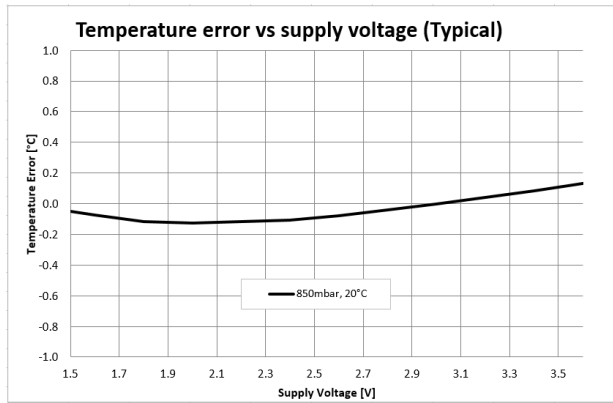
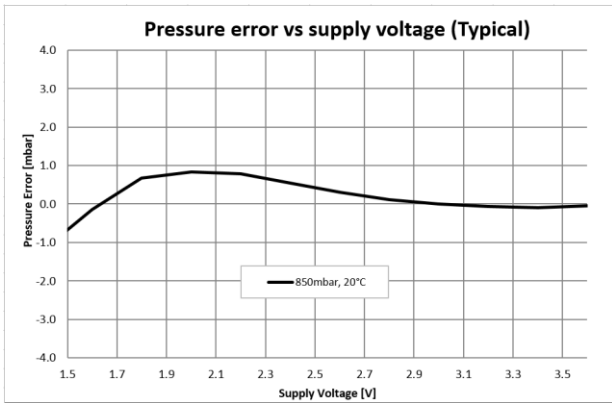

MS5839-02BA

Ultra-compact, chlorine resistant, digital pressure and temperature sensor

PRESSURE AND TEMPERATURE CALCULATION

GENERAL

The MS5839 consists of a piezo-resistive sensor and a sensor interface integrated circuit. The main function of the MS5839 is to convert the uncompensated analogue output voltage from the piezo-resistive pressure sensor to a 24-bit digital value, as well as providing a 24-bit digital value for the temperature of the sensor.

FACTORY CALIBRATION

Every module is individually factory calibrated at two temperatures and two pressures. As a result, 6 coefficients necessary to compensate for process variations and temperature variations are calculated and stored in the 112-bit PROM of each module. These bits (partitioned into 6 coefficients) must be read by the microcontroller software and used in the program converting D1 and D2 into compensated pressure and temperature values.

COMMUNICATION INTERFACE

The MS5839 has been built with I²C serial interface.

Module ref	Mode	Pins used
MS5839-02BA36	I ² C	SDA, SCL

The external microcontroller clocks in the data through the input SCL (Serial CLock) and SDA (Serial DAta). The sensor responds on the same pin SDA which is bidirectional for the I²C bus interface. This interface type uses only 2 signal lines and does not require a chip select.

FIRST ORDER PRESSURE AND TEMPERATURE CALCULATION

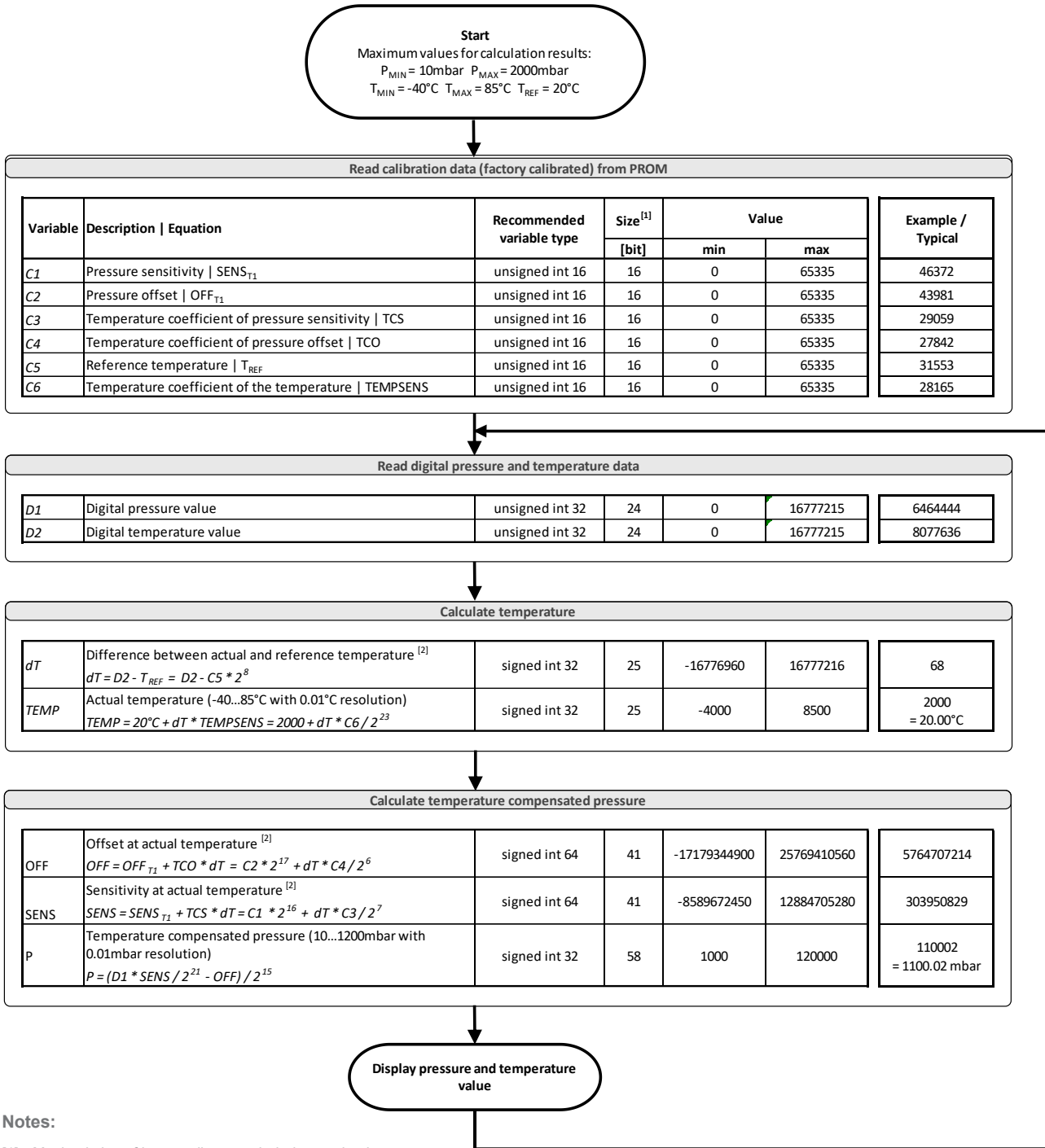

Notes:

- [1] Maximal size of intermediate result during evaluation of variable
- [2] Min and max have to be defined

Figure 1 : Pressure and temperature first order

SECOND ORDER TEMPERATURE COMPENSATION

The results of the first order calculation are used as described in the following chart to obtain the 2nd order pressure and temperature compensated values.

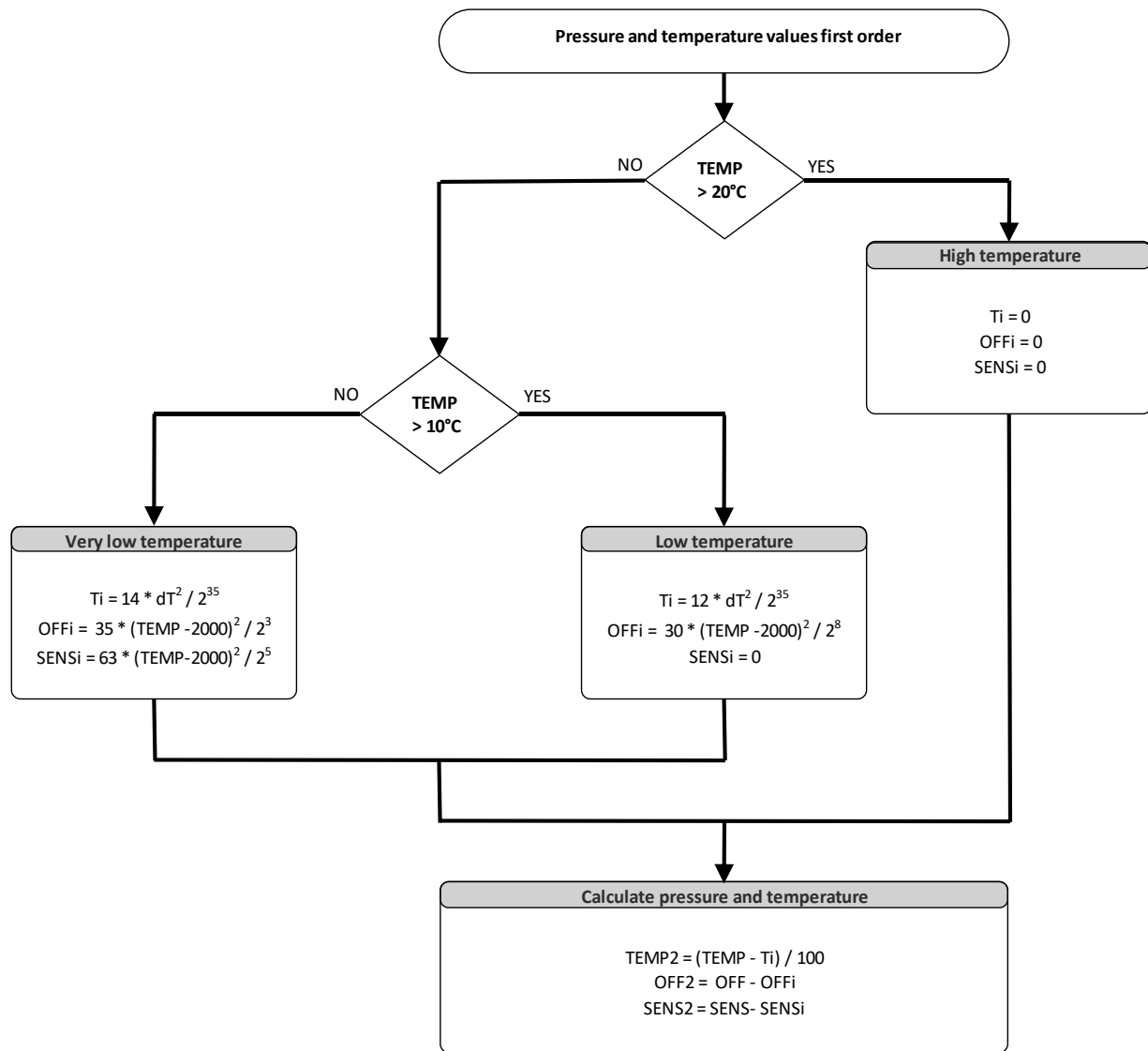

Figure 2 : Second order compensation flowchart

I²C INTERFACE**COMMANDS**

The MS5839 has only five basic commands:

1. Reset
2. Read PROM (112 bit of calibration words)
3. D1 conversion
4. D2 conversion
5. Read ADC result (24 bit pressure / temperature)

Each I²C communication message starts with the start condition and it is ended with the stop condition. The MS5839 address is 1110110x (write: x=0, read: x=1).

Size of each command is 1 byte (8 bits) as described in the table below. After ADC read commands, the device will return 24 bit result and after the PROM read 16 bit results. The address of the PROM is embedded inside of the PROM read command using the a2, a1 and a0 bits.

Bit number	Command byte								hex value
	0	1	2	3	4	5	6	7	
Bit name	PRO M	CO NV	-	Typ	Ad2/ Os2	Ad1/ Os1	Ad0/ Os0	Stop	
Command									
Reset	0	0	0	1	1	1	1	0	0x1E
Convert D1 (OSR=256)	0	1	0	0	0	0	0	0	0x40
Convert D1 (OSR=512)	0	1	0	0	0	0	1	0	0x42
Convert D1 (OSR=1024)	0	1	0	0	0	1	0	0	0x44
Convert D1 (OSR=2048)	0	1	0	0	0	1	1	0	0x46
Convert D1 (OSR=4096)	0	1	0	0	1	0	0	0	0x48
Convert D1 (OSR=8192)	0	1	0	0	1	0	1	0	0x4A
Convert D2 (OSR=256)	0	1	0	1	0	0	0	0	0x50
Convert D2 (OSR=512)	0	1	0	1	0	0	1	0	0x52
Convert D2 (OSR=1024)	0	1	0	1	0	1	0	0	0x54
Convert D2 (OSR=2048)	0	1	0	1	0	1	1	0	0x56
Convert D2 (OSR=4096)	0	1	0	1	1	0	0	0	0x58
Convert D2 (OSR=8192)	0	1	0	1	1	0	1	0	0x5A
ADC Read	0	0	0	0	0	0	0	0	0x00
PROM Read	1	0	1	0	Ad2	Ad1	Ad0	0	0xA0 to 0xAE

Command structure

RESET SEQUENCE

The Reset sequence shall be sent once after power-on to make sure that the calibration PROM gets loaded into the internal register. It can be also used to reset the device PROM from an unknown condition. The reset can be sent at any time. In the event that there is not a successful power on reset this may be caused by the SDA being blocked by the module in the acknowledge state. The only way to get the MS5839 to function is to send several SCLs followed by a reset sequence or to repeat power on reset.

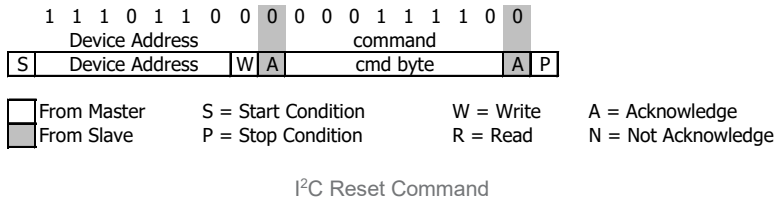

PROM READ SEQUENCE

The read command for PROM shall be executed once after reset by the user to read the content of the calibration PROM and to calculate the calibration coefficients. There are in total 7 addresses resulting in a total memory of 112 bit. Addresses contain factory data and the setup, calibration coefficients, the serial code and CRC. The command sequence is 8 bits long with a 16 bit result which is clocked with the MSB first. The PROM Read command consists of two parts. First command sets up the system into PROM read mode. The second part gets the data from the system.

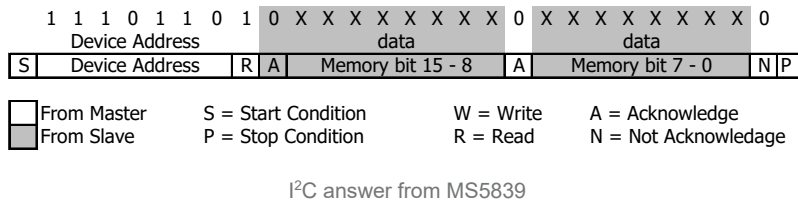
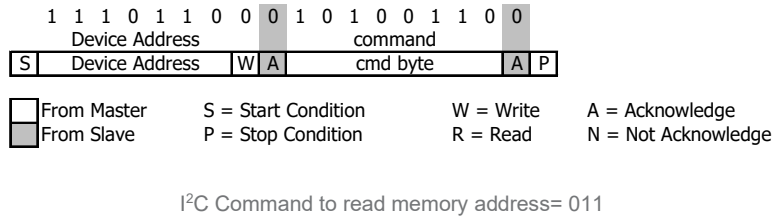

MS5839-02BA

Ultra-compact, chlorine resistant, digital pressure and temperature sensor

CONVERSION SEQUENCE

The conversion command is used to initiate uncompensated pressure (D1) or uncompensated temperature (D2) conversion. After the conversion, using ADC read command the result is clocked out with the MSB first. If the conversion is not executed before the ADC read command, or the ADC read command is repeated, it will give 0 as the output result. If the ADC read command is sent during conversion the result will be 0, the conversion will not stop and the final result will be wrong. Conversion sequence sent during the already started conversion process will yield incorrect result as well. A conversion can be started by sending the command to MS5839. When command is sent to the system it stays busy until conversion is done. When conversion is finished the data can be accessed by sending a Read command, when an acknowledge is sent from the MS5839, 24 SCL cycles may be sent to receive all result bits. Every 8 bits the system waits for an acknowledge signal.

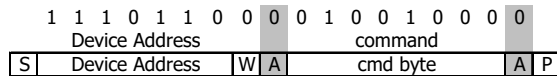

From Master S = Start Condition W = Write A = Acknowledge
 From Slave P = Stop Condition R = Read N = Not Acknowledge

I²C command to initiate a pressure conversion (OSR=4096, typ=D1)

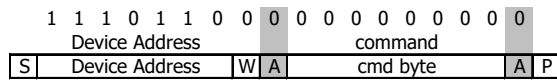

From Master S = Start Condition W = Write A = Acknowledge
 From Slave P = Stop Condition R = Read N = Not Acknowledge

I²C ADC read sequence

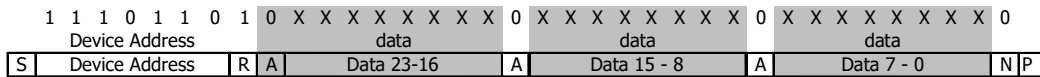

From Master S = Start Condition W = Write A = Acknowledge
 From Slave P = Stop Condition R = Read N = Not Acknowledge

I²C answer from MS5839

VERSION PROM WORD 0 PROGRAMMING

For product type, the bits [11:5] of memory address 0 must be programmed with the following fixed values:

MS5839-02BA36

Address	15	14	13	12	11	10	9	8	7	6	5	4	3	2	1	0
0	crc				0	1	0	0	1	0	0	factory settings				

MS5839-02BA

Ultra-compact, chlorine resistant, digital pressure and temperature sensor

CYCLIC REDUNDANCY CHECK (CRC)

MS5839 contains a PROM memory with 112-Bit. A 4-bit CRC has been implemented to check the data validity in memory.

MS5839-02BA															
A	D	D	D	D	D	D	D	D	D	D	D	D	D	D	D
d	B	B	B	B	B	B	B	B	B	B	B	B	B	B	B
d	1	1	1	1	1	1	9	8	7	6	5	4	3	2	1
	5	4	3	2	1	0									0
0	CRC			Version defined				Factory defined							
1	C1														
2	C2														
3	C3														
4	C4														
5	C5														
6	C6														

Memory PROM mapping

C Code example for CRC-4 calculation:

```
unsigned char crc4(unsigned int n_prom[]) // n_prom defined as 8x unsigned int (n_prom[8])
{
    int cnt; // simple counter
    unsigned int n_rem=0; // crc remainder
    unsigned char n_bit;

    n_prom[0]=((n_prom[0]) & 0x0FFF); // CRC byte is replaced by 0
    n_prom[7]=0; // Subsidiary value, set to 0
    for (cnt = 0; cnt < 16; cnt++) // operation is performed on bytes
    { // choose LSB or MSB
        if (cnt%2==1) n_rem ^= (unsigned short) ((n_prom[cnt]>>1]) & 0x00FF);
        else n_rem ^= (unsigned short) (n_prom[cnt]>>1]>>8);
        for (n_bit = 8; n_bit > 0; n_bit--)
        {
            if (n_rem & (0x8000)) n_rem = (n_rem << 1) ^ 0x3000;
            else n_rem = (n_rem << 1);
        }
    }
    n_rem= ((n_rem >> 12) & 0x000F); // final 4-bit remainder is CRC code
    return (n_rem ^ 0x00);
}
```

MS5839-02BA

Ultra-compact, chlorine resistant, digital pressure and temperature sensor

APPLICATION CIRCUIT

The MS5839 is a circuit that can be used in conjunction with a microcontroller in mobile altimeter applications.

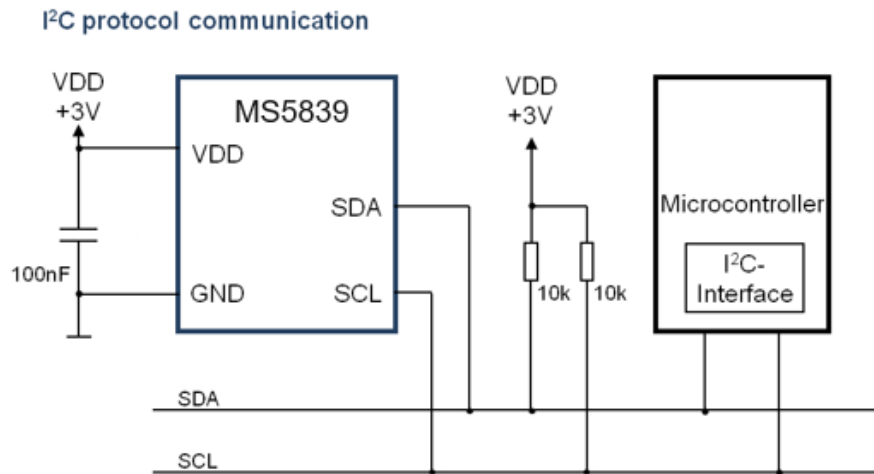
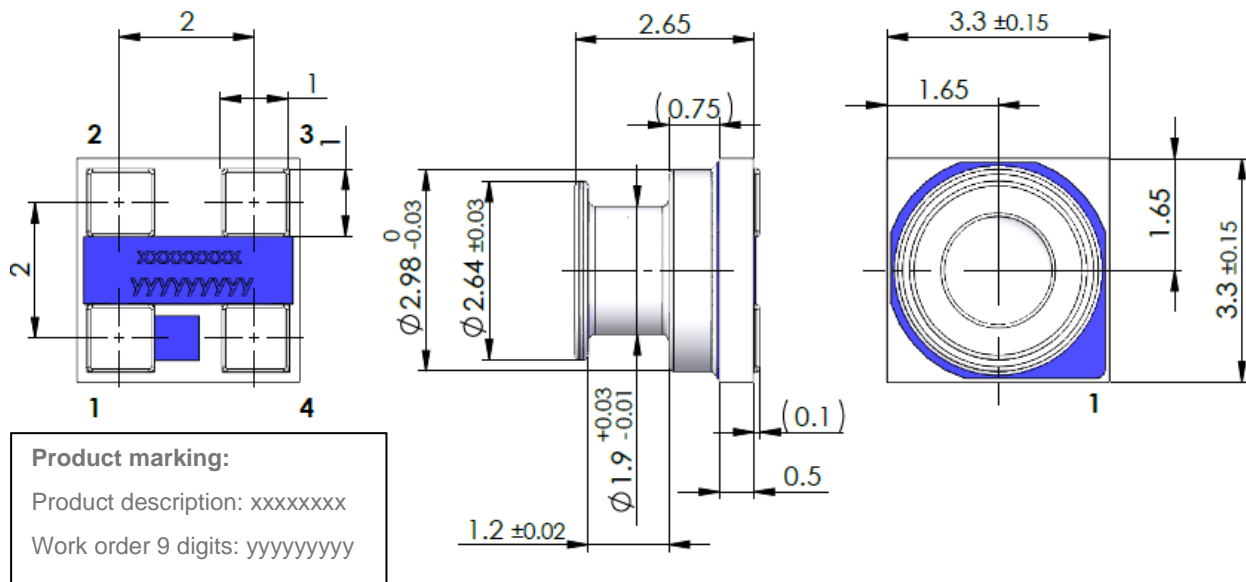

Figure: Typical application circuit

PIN CONFIGURATION AND DEVICE PACKAGE OUTLINE

UNLESS OTHERWISE SPECIFIED DIMENSIONS ARE IN MILLIMETERS. GENERAL TOLERANCE $\pm 0.1\text{mm}$



1	GND	GROUND
2	VDD	POSITIVE SUPPLY
3	SCL	I ² C CLOCK
4	SDA	I ² C DATA

Figure: Package outlines and Pin configuration

MS5839-02BA

Ultra-compact, chlorine resistant, digital pressure and temperature sensor

RECOMMENDED PAD LAYOUT

Pad layout for bottom side of the MS5839 soldered onto printed circuit board.

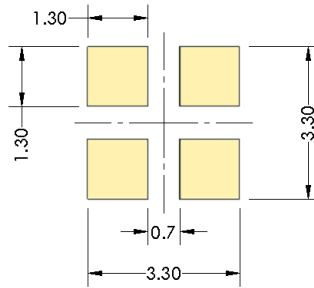

Figure

SHIPPING PACKAGE

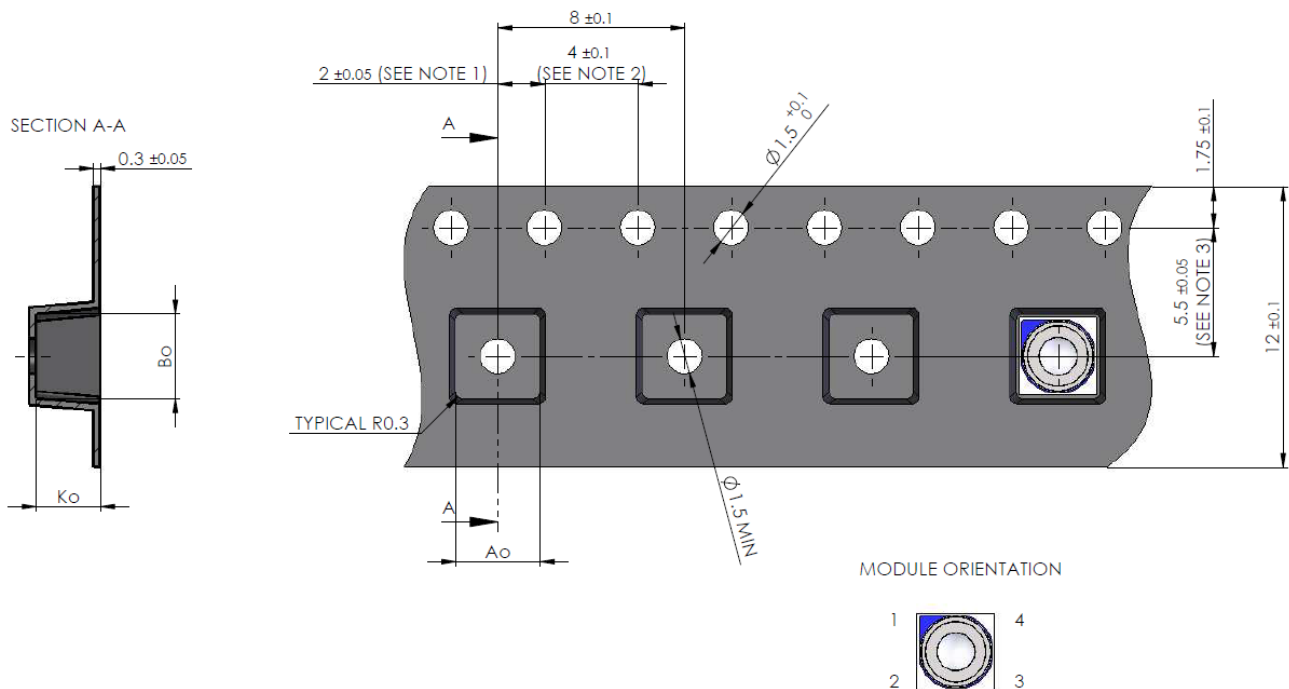

A ₀	3.6±0.1
B ₀	3.6±0.1
K ₀	2.75±0.1

NOTE:

- 1: Measured from centerline of sprocket hole to centerline of pocket
- 2: Cumulative tolerance of 10 sprocket holes is ±0.2mm
- 3: Measured from centerline of sprocket hole to centerline of pocket

MS5839-02BA

Ultra-compact, chlorine resistant, digital pressure and temperature sensor

MOUNTING AND ASSEMBLY CONSIDERATIONS

SOLDERING

Please refer to the application note AN808 available on our website for soldering recommendations.

MOUNTING

The MS5839 can be placed with automatic Pick & Place equipment using vacuum nozzles. It will not be damaged by the vacuum.

Due to the low stress assembly, the sensor does not show pressure hysteresis effects. It is important to solder all contact pads. Gel must stay free of external physical contact when manipulation.

CONNECTION TO PCB

The package outline of the module allows the use of a flexible PCB for interconnection. This can be important for applications in watches and other special devices.

SEALING WITH O-RINGS

In applications such as outdoor watches the electronics must be protected against direct water or humidity. For such applications the MS5839 provides the possibility to seal with an O-ring. The O-ring shall be placed at the groove location, i.e. the small outer diameter of the metal lid. The following O-ring / housing dimensions are recommended:

O-ring inner diameter	1.8 ± 0.05 mm
O-ring cross-section diameter	0.8 ± 0.03 mm
Housing bore diameter	3.07 ± 0.03 mm

Please refer to the application note AN523 available on our website for O-ring mounting recommendations.

CLEANING

The MS5839 has been manufactured under clean-room conditions. It is therefore recommended to assemble the sensor under class 10'000 or better conditions. Should this not be possible, it is recommended to protect the sensor opening during assembly from entering particles and dust. To avoid cleaning of the PCB, solder paste of type "no-clean" shall be used. Warning: cleaning might damage the sensor.

ESD PRECAUTIONS

The electrical contact pads are protected against ESD. It is therefore essential to ground machines and personnel properly during assembly and handling of the device. The MS5839 is shipped in antistatic transport boxes. Any test adapters or production transport boxes used during the assembly of the sensor shall be of an equivalent antistatic material.

DECOUPLING CAPACITOR

Particular care must be taken when connecting the device to the power supply. A 100nF minimum ceramic capacitor must be placed as close as possible to the MS5839 VDD pin. This capacitor will stabilize the power supply during data conversion and thus, provide the highest possible accuracy.

MS5839-02BA

Ultra-compact, chlorine resistant, digital pressure and temperature sensor

ORDERING INFORMATION

PART NUMBER	DESCRIPTION	SHIELDING	CHLORINE RESISTANT
20008669-50	MS5839-02BA36 CL RESISTANT LS T&R SEN	X	X

NORTH AMERICA

Tel +1 800 522 6752
customer-care.fgmt@te.com

EUROPE

Tel +31 73 624 6999
customer-care.bevx@te.com

ASIA

Tel +86 0400 820 6015
customer-care.shzn@te.com

te.com/sensorsolutions

TE Connectivity, TE Connectivity (logo) and EVERY CONNECTION COUNTS are trademarks. All other logos, products and/or company names referred to herein might be trademarks of their respective owners.

The information given herein, including drawings, illustrations and schematics which are intended for illustration purposes only, is believed to be reliable. However, TE Connectivity makes no warranties as to its accuracy or completeness and disclaims any liability in connection with its use. TE Connectivity's obligations shall only be as set forth in TE Connectivity's Standard Terms and Conditions of Sale for this product and in no case will TE Connectivity be liable for any incidental, indirect or consequential damages arising out of the sale, resale, use or misuse of the product. Users of TE Connectivity products should make their own evaluation to determine the suitability of each such product for the specific application.

© 2019 TE Connectivity Ltd. family of companies All Rights Reserved.