

REVISIONS				
P	LTN	DESCRIPTION	DATE	APP'D
A3		REVISED PER PCN-22-153672	22SEP2022	AM 1G
A4		REVISED PER PCN-22-154549	04OCT2022	AM 1G
A5		REVISED PER PCN-23-190838	26OCT2023	AJ CB
B		REVISED PER PCN-23-192205	06FEB2024	RK CB

FIGURE 1

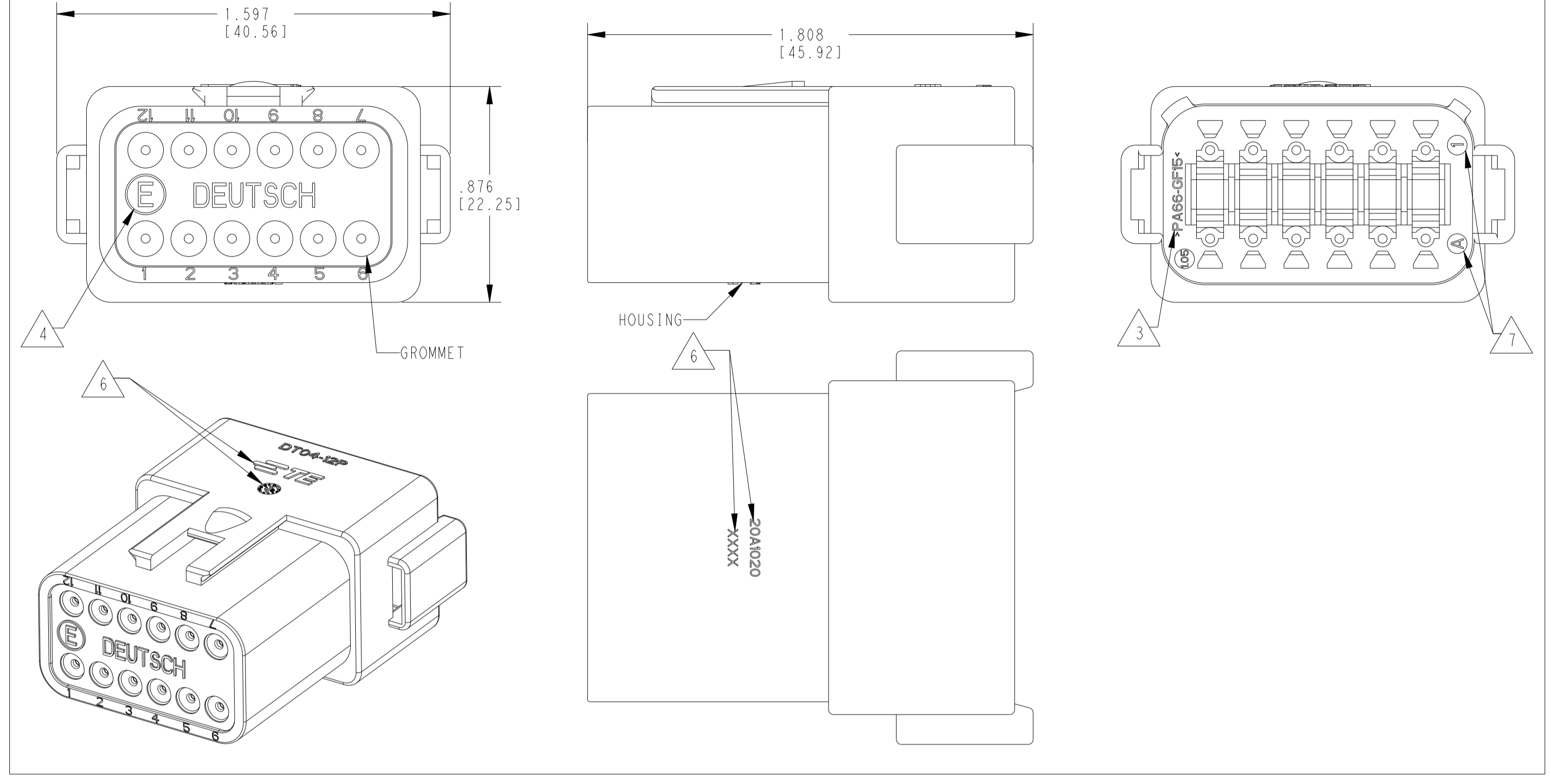

FIGURE 2 SHORT CAP

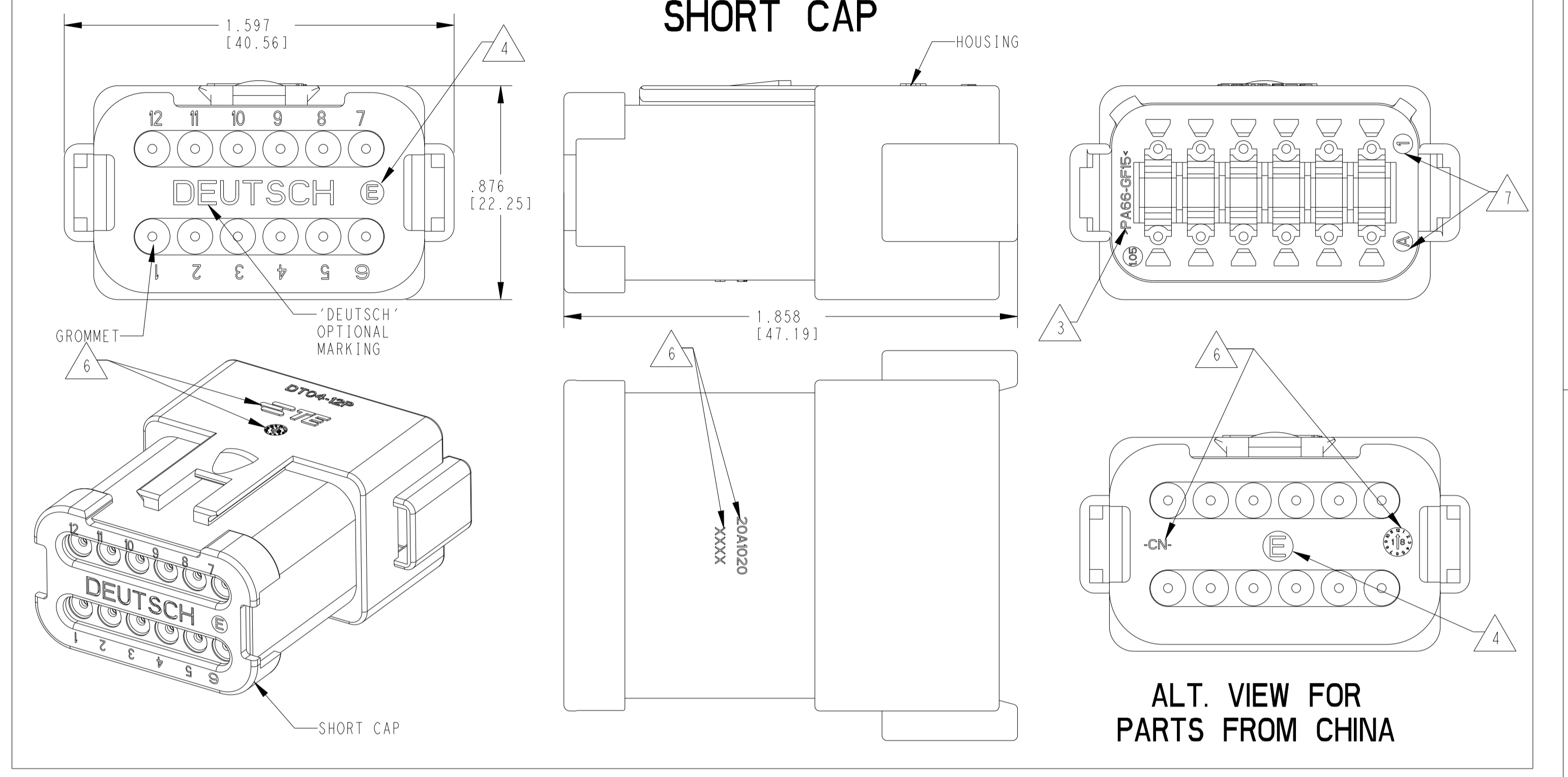
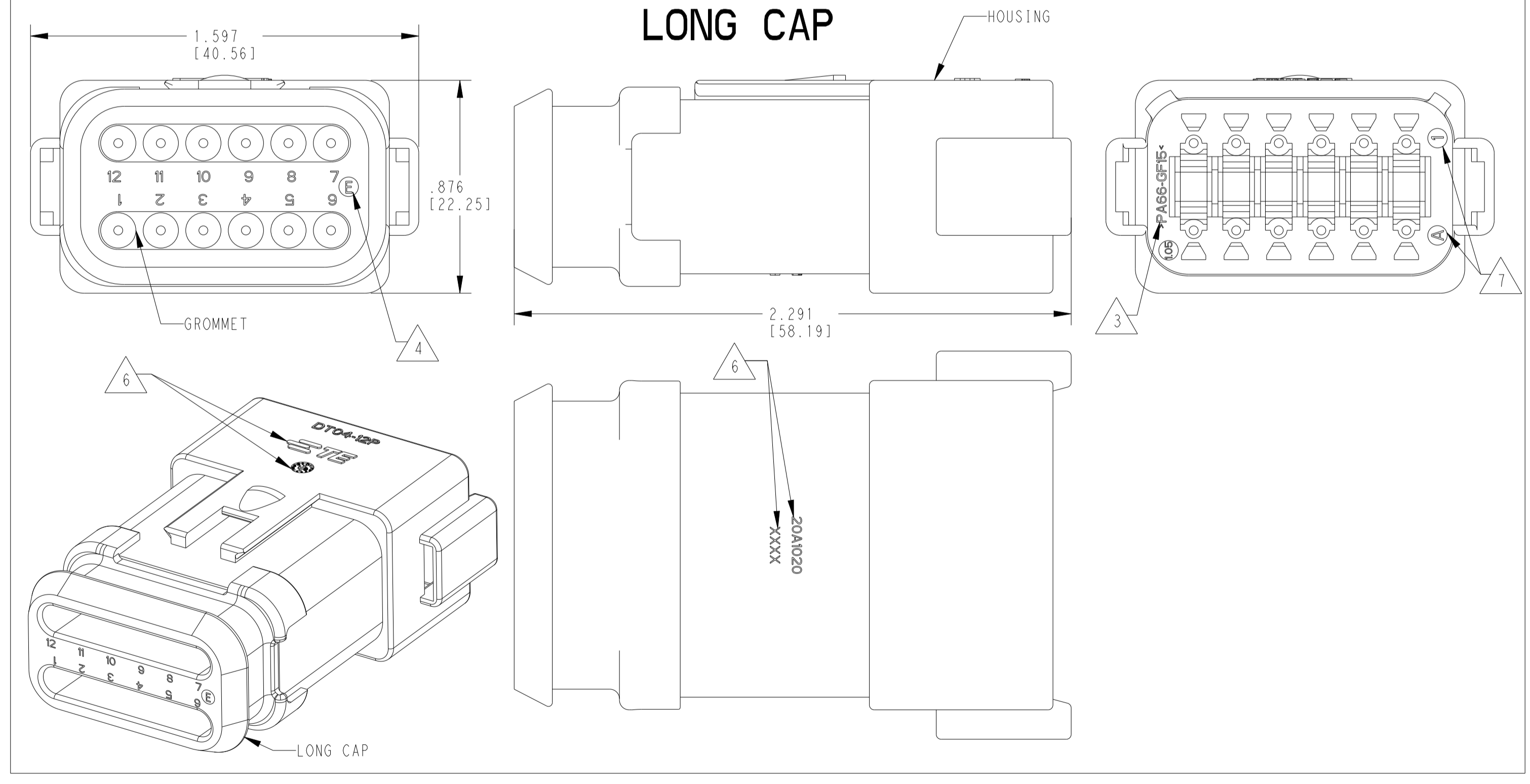

FIGURE 3 LONG CAP



CONTACT SIZE	WIRE RANGE	INSULATION OD SEALING RANGE	SEAL IDENTIFICATION
16	14-20 AWG [2.5-0.5mm ²]	.088-.145 [2.23-3.68] .053-.120 [1.35-3.05]	STANDARD SEAL EXTRA THIN SEAL E-SEAL

TE INTERNAL PART NUMBER	DEUTSCH PART NUMBER	PN REV	HOUSING COLOR	STANDARD SEAL	EXTRA THIN SEAL E-SEAL	BLOCKED SEAL	ENHANCED KEY	SHORT CAP	LONG CAP	FIGURE
DT04-12PX	DT04-12PX	A	ALL	X						1
DT04-12PX-B016	DT04-12PX-B016	A	ALL	X			X			1
DT04-12PX-BE01	DT04-12PX-BE01	B	ALL	X			X	X		2
DT04-12PX-BE02	DT04-12PX-BE02	B	ALL	X			X	X		2
DT04-12PA-BE03	DT04-12PA-BE03	A	BLACK	X			X	X		2
DT04-12PA-BE04	DT04-12PA-BE04	B	BLACK		X		X	X		2
DT04-12PX-BE07	DT04-12PX-BE07	B	ALL		X		X		X	3
DT04-12PX-C015	DT04-12PX-C015	F	ALL		X					1
DT04-12PX-C017	DT04-12PX-C017	B	ALL			X		X		2
DT04-12PX-CE01	DT04-12PX-CE01	C	ALL		X			X		2
DT04-12PA-CE02	DT04-12PA-CE02	B	BLACK		X					1
DT04-12PA-CE03	DT04-12PA-CE03	B	BLACK		X			X		2
DT04-12PX-CE04	DT04-12PX-CE04	C	ALL		X				X	3
DT04-12PX-CE07	DT04-12PX-CE07	C	ALL		X		X	X		2
DT04-12PX-CE08	DT04-12PX-CE08	B	ALL		X		X			1
DT04-12PA-CE09	DT04-12PA-CE09	B	BLACK		X				X	3
DT04-12PA-CE26	DT04-12PA-CE26	A	BLACK			X		X		2
DT04-12PX-E003	DT04-12PX-E003	C	ALL	X				X		2
DT04-12PA-E004	DT04-12PA-E004	A	BLACK	X						1
DT04-12PA-E005	DT04-12PA-E005	A	BLACK	X				X		2
DT04-12PA-E008	DT04-12PA-E008	B	GRAY	X					X	3
DT04-12PX-EP04	DT04-12PX-EP04	D	ALL	X				X		2
DT04-12PA-EP20	DT04-12PA-EP20	B	GRAY	X			X		X	3
DT04-12PX-P004	DT04-12PX-P004	B	ALL	X						1

ALT. VIEW FOR PARTS FROM US

6. MARKING FOR PARTS PRODUCED IN CHINA:

-XXXX IDENTIFIES THE MODIFICATION NUMBER, IF APPLICABLE. EXAMPLE: "E003" FOR DT04-12PA-E003, OR BLANK FOR DT04-12PA
 -DATE CODE: IDENTIFIES THE YEAR, MONTH, DAY AND HOUR OF ASSEMBLY.
 YEAR: FIRST AND SECOND DIGIT. (17 = 2017)
 MONTH: THIRD DIGIT, EXCLUDING 1. A = JAN, B = FEB, C = MARCH ... (K = OCTOBER)
 DAY: FOURTH AND FIFTH DIGITS (14 = 14th DAY)
 HOUR: SIXTH AND SEVENTH DIGITS (11 = 11AM)
 -DIAL DATE CODE LOCATED ON HOUSING AND/OR CAP.
 -CN LOCATED ON HOUSING AND/OR CAP.

7. MARKING FOR PARTS PRODUCED IN US:
 -DATE CODE:
 YEAR TO BE LAST NUMERICAL DIGIT, EX: 1 = 2021
 MONTH USES SEQUENTIAL ALPHA CHARACTERS, EX: A = JANUARY
 -DEUTSCH

4. "E" IDENTIFIES E-SEAL, LOCATED APPROX. AS SHOWN.
 3. MATERIAL: HOUSING: PA66 GF15, SEE TABLE FOR COLOR
 SHORT, LONG CAP: PA66 GF15, BLACK
 GROMMET: E-SEAL VMO (BURNT RED)
 N-SEAL VMO (RED-ORANGE)
 BLOCKED VMO (RED-ORANGE)
 2. THIS RECEPTACLE MATES WITH DT06-12SX-XXXX PLUG (XXXX = ALL MODIFICATIONS)
 1. SECONDARY WEDGE LOCK SOLD SEPARATELY: W12PX-XXXX. (X = A,B,C,D KEY, XXXX = ALL MODIFICATIONS)

NOTES: UNLESS OTHERWISE SPECIFIED

THIS DRAWING IS A CONTROLLED DOCUMENT.

DIMENSIONS: IN [mm]	TOLERANCES UNLESS OTHERWISE SPECIFIED: 0 PLC ± 1 PLC ± 2 PLC ± 3 PLC ±.025 (0.64) 4 PLC ± ANGLES ±30° FINISH	OWN: A. POLO 22DEC2021 CHK: R. MESSENGER 22DEC2021 APP'D: J. GRANICHAROVA 22DEC2021 PRODUCT SPEC 108-151009 APPLICATION SPEC 114-151009 WEIGHT	NAME: 12 WAY RECEPTACLE, STANDARD SEAL EXTRA THIN SEAL, SHORT AND LONG CAP, DT SERIES SIZE: 4FU8 CAGE CODE: DT04-12PX-XXXX RESTRICTED TO: -
------------------------	---	---	--

CUSTOMER DRAWING SCALE: 5:2 SHEET 1 OF 3 REV B

REVISIONS				
P	LTN	DESCRIPTION	DATE	APVD
-		SEE SHEET 1	-	-

DT04-12PA-XXXX
 KEY -A-
 HOUSING COLOR: GRAY
 SEE PN TABLE FOR BLACK PN

DT04-12PB-XXXX
 KEY -B-
 HOUSING COLOR: BLACK

DT04-12PC-XXXX
 KEY -C-
 HOUSING COLOR: GREEN

DT04-12PD-XXXX
 KEY -D-
 HOUSING COLOR: BROWN

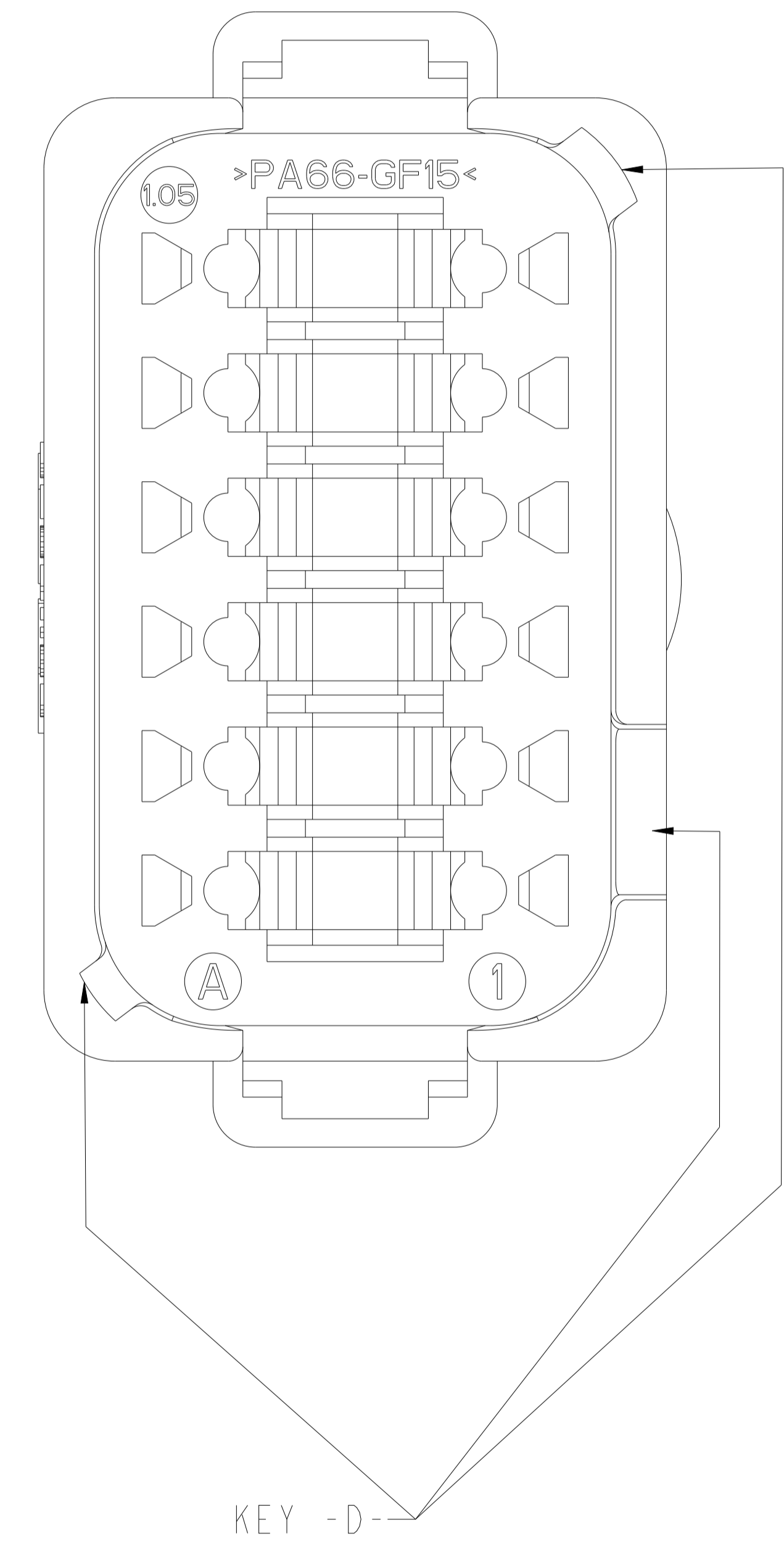
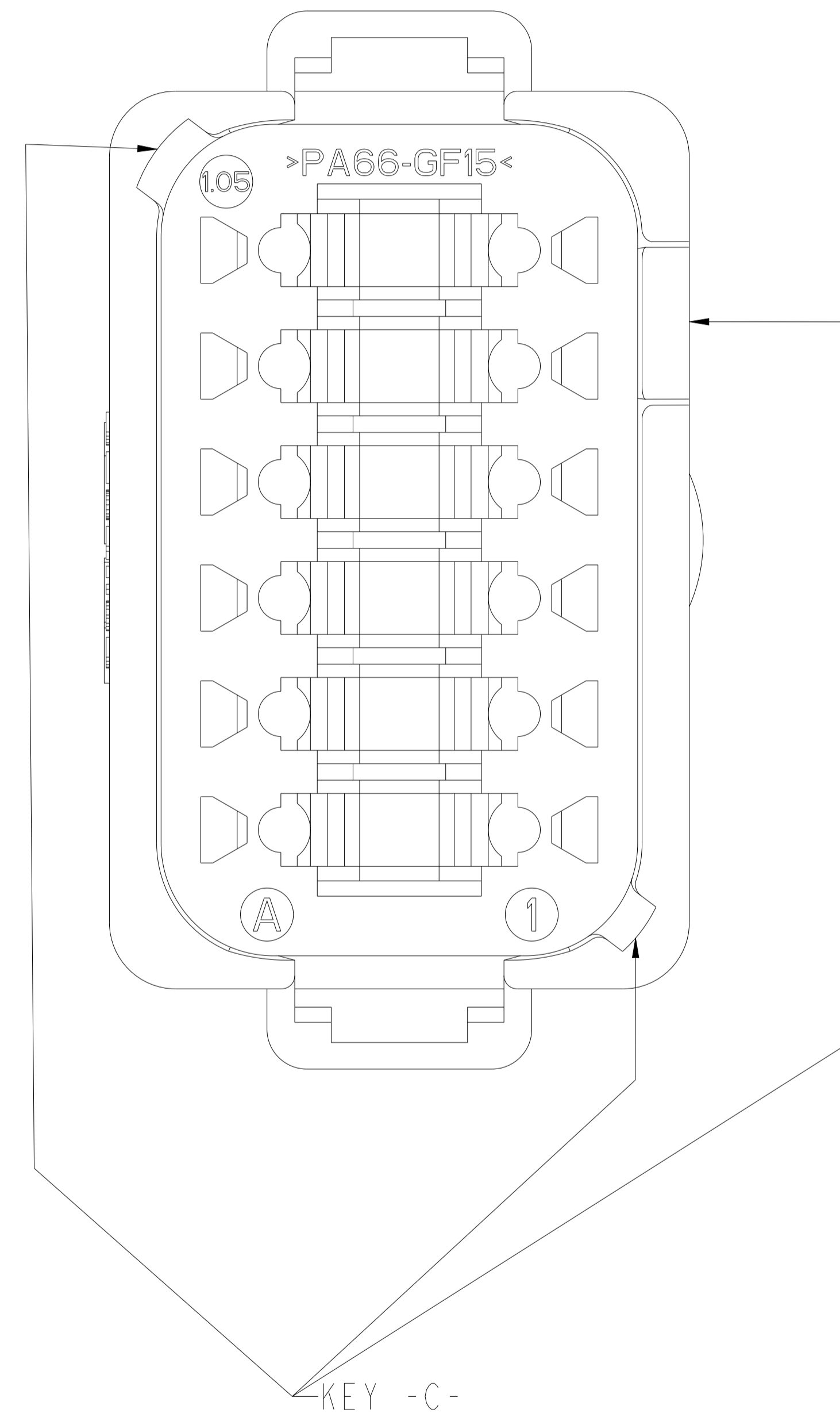
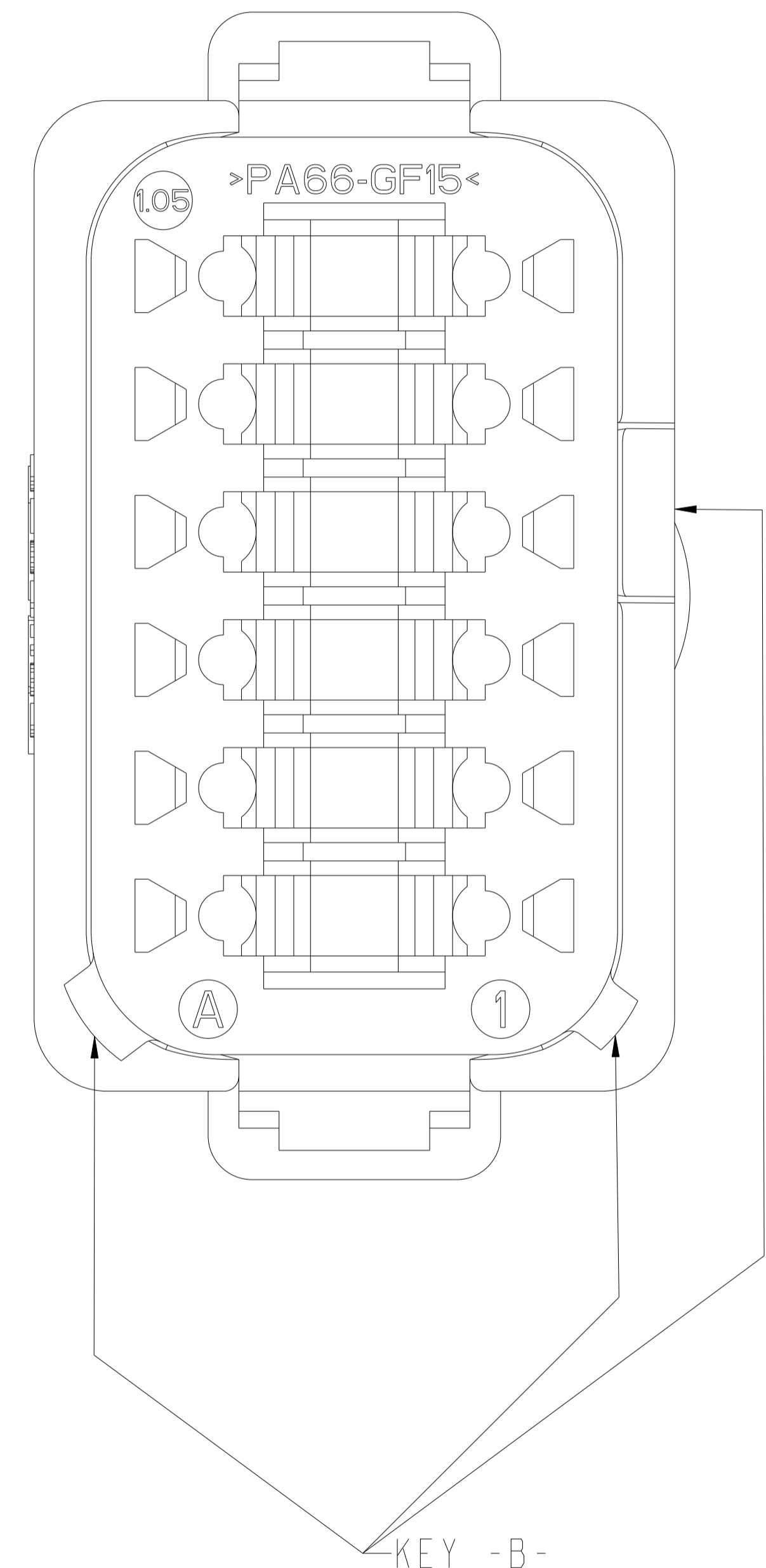
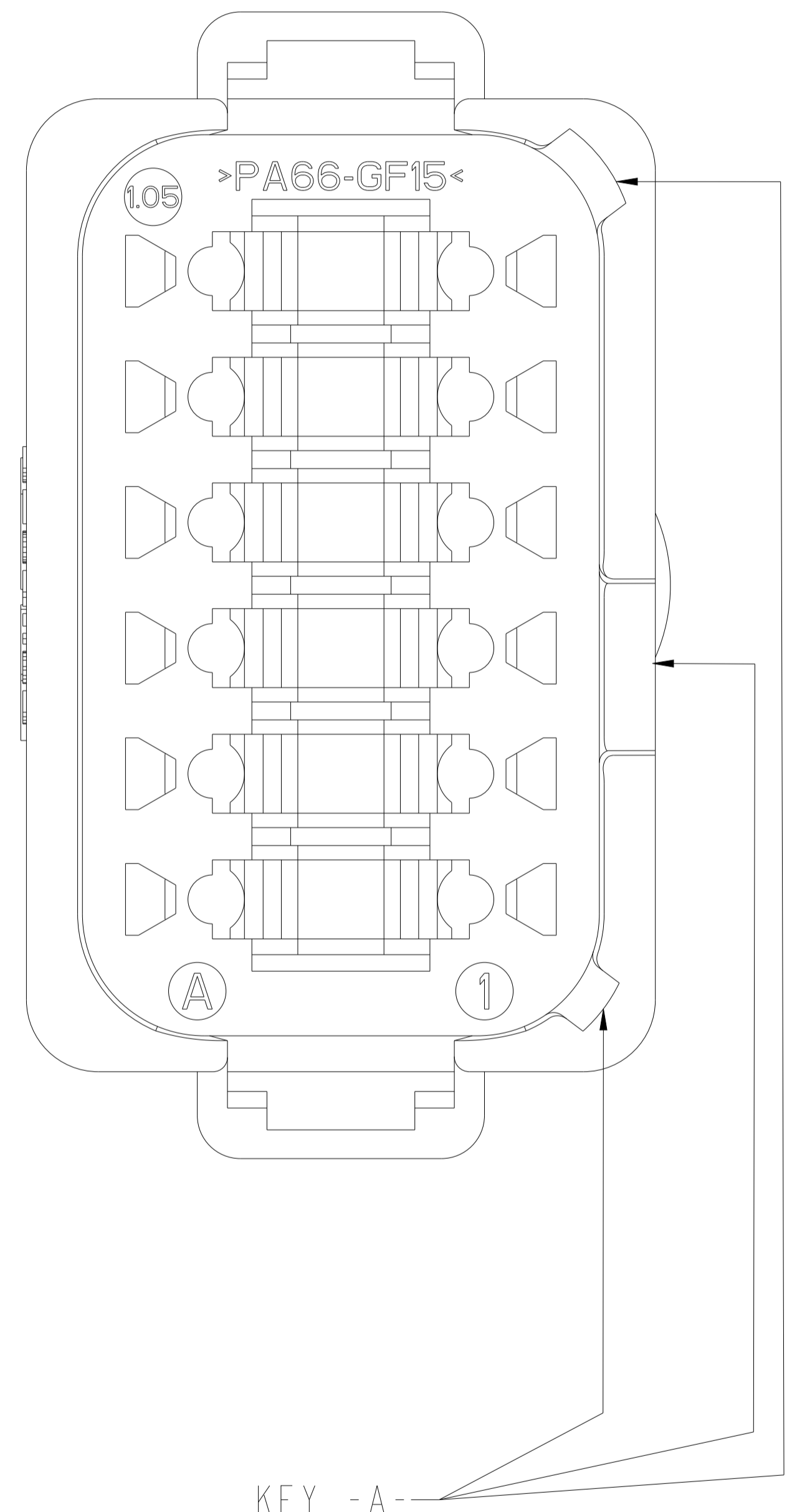

THIS DRAWING IS A CONTROLLED DOCUMENT.		DWN A. POLO 22DEC2021 CHK R. MESSENGER 22DEC2021 APVD J. GRANICHAROVA 22DEC2021	
DIMENSIONS: IN [mm]	TOLERANCES UNLESS OTHERWISE SPECIFIED: 0 PLC ± 1 PLC ± 2 PLC ± 3 PLC ±0.25 (0.64) 4 PLC ± ANGLES ±0°30'0" FINISH	NAME 12 WAY RECEPTACLE, STANDARD SEAL EXTRA THIN SEAL, SHORT AND LONG CAP, DT SERIES SIZE CAGE CODE DRAWING NO A 4AFU8 C=DT04-12PX-XXXX	
MATERIAL 3		PRODUCT SPEC 108-151009 APPLICATION SPEC 114-151009 WEIGHT CUSTOMER DRAWING	RESTRICTED TO SCALE 5:2 SHEET 2 OF 3 REV B

REVISIONS				
P	LTN	DESCRIPTION	DATE	APVD
-		SEE SHEET 1	-	-

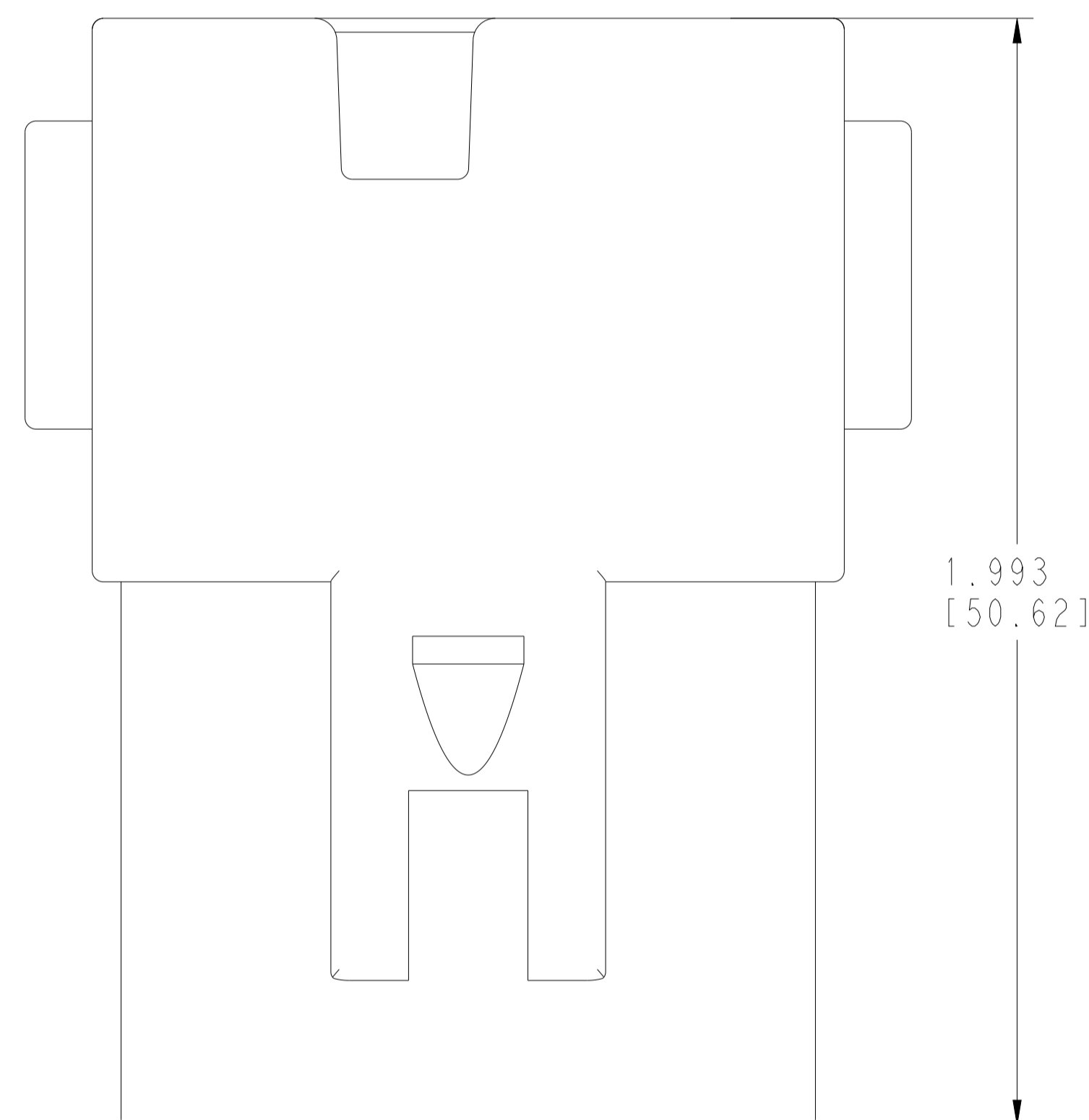

**ENHANCED KEY
NO CAP
HOUSING COLOR: SEE TABLE**

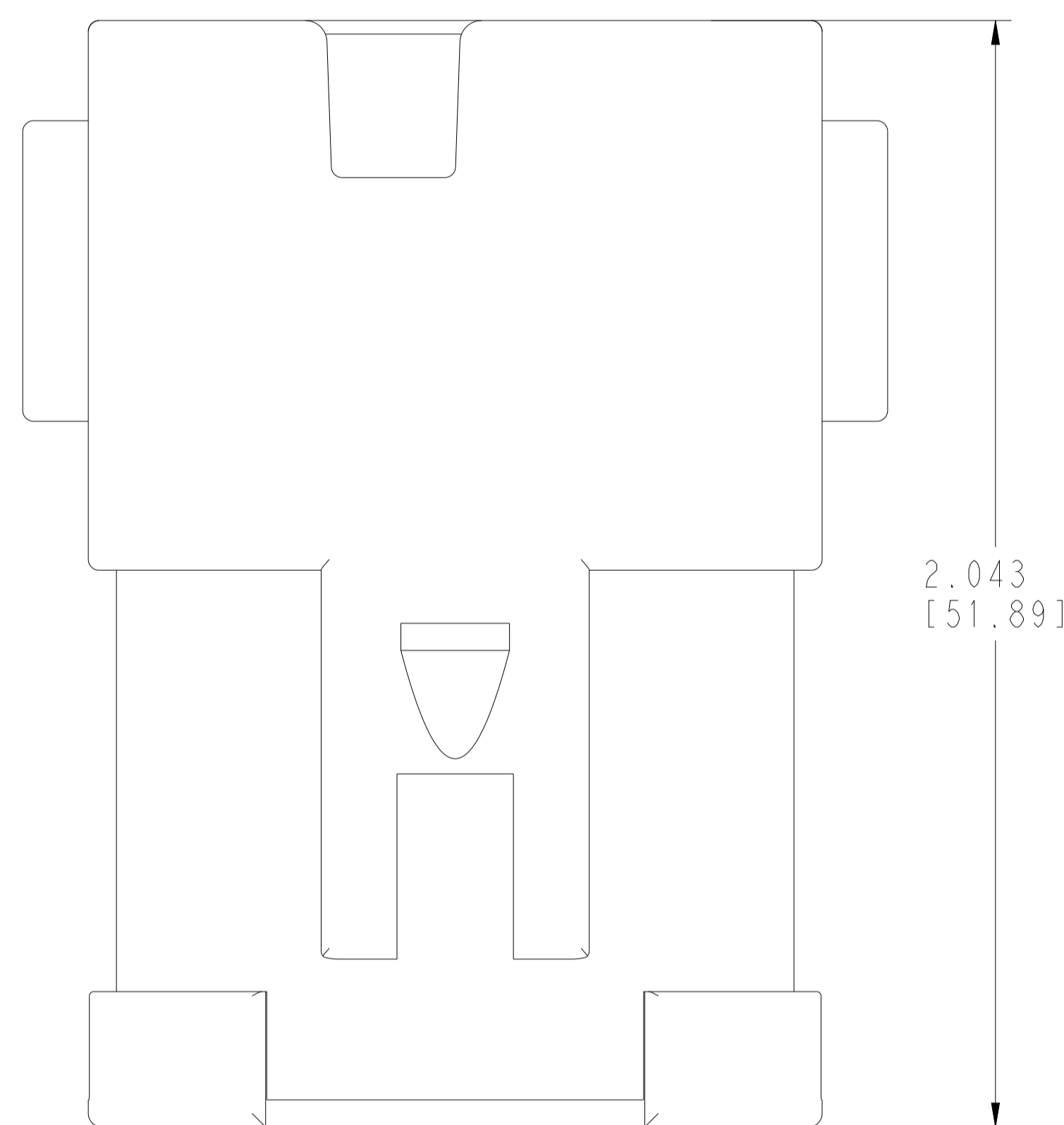

**ENHANCED KEY
SHORT CAP
HOUSING COLOR: SEE TABLE
SHORT CAP COLOR: BLACK**

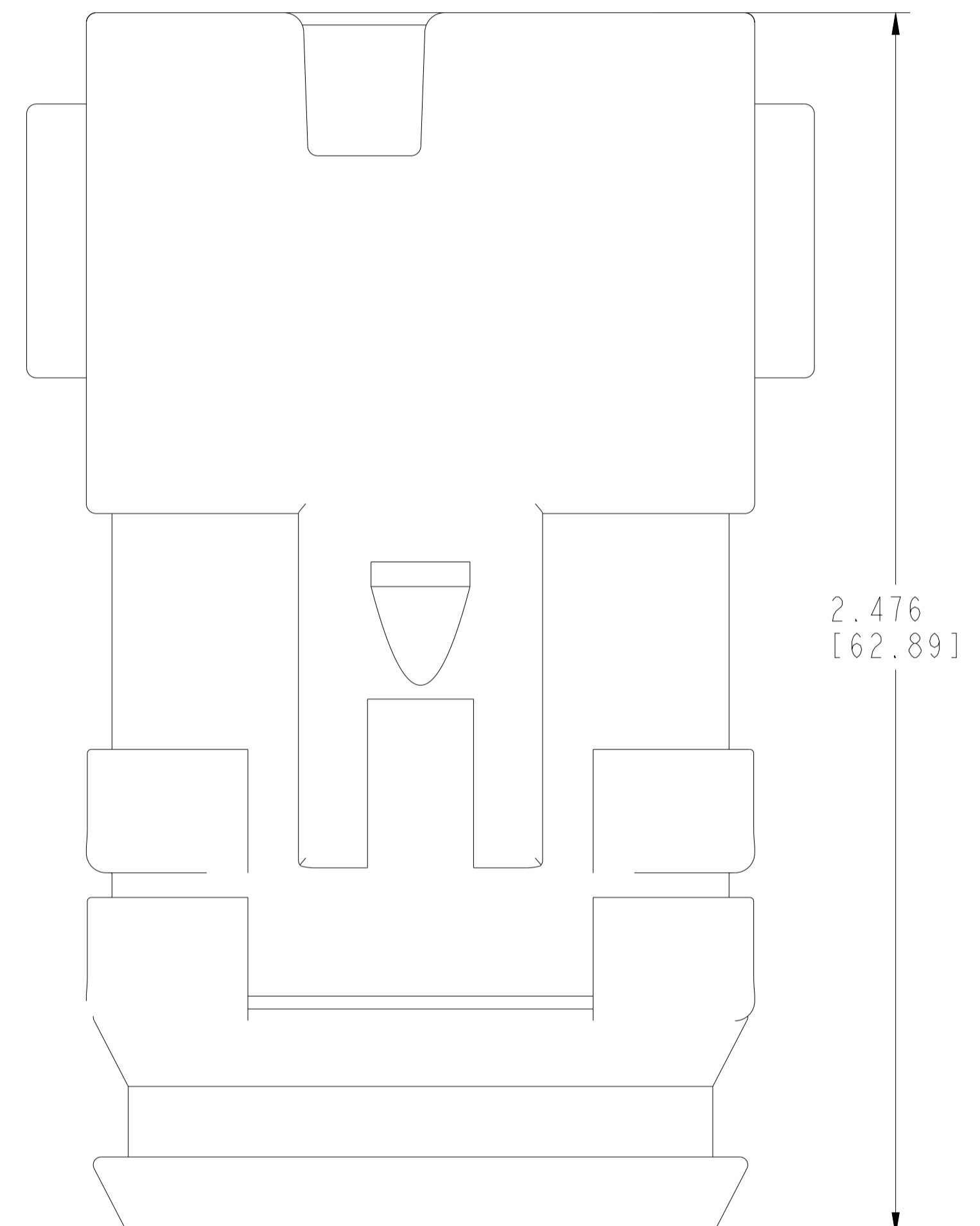

**ENHANCED KEY
LONG CAP
HOUSING COLOR: SEE TABLE
LONG CAP COLOR: BLACK**

THIS DRAWING IS A CONTROLLED DOCUMENT.		DWN A. POLO 22DEC2021	
		CHK R. MESSENGER 22DEC2021	
DIMENSIONS: IN [mm]	TOLERANCES UNLESS OTHERWISE SPECIFIED:	APVD I. GRANICHAROVA 22DEC2021	NAME 12 WAY RECEPTACLE, STANDARD SEAL EXTRA THIN SEAL, SHORT AND LONG CAP, DT SERIES
	0 PLC ±	PRODUCT SPEC	SIZE A 4AFU8
	1 PLC ±	APPLICATION SPEC	CAGE CODE C=DT04-12PX-XXXX
	2 PLC ±		RESTRICTED TO
	3 PLC ± 0.25 (0.64)		SCALE 5:2
	4 PLC ±	WEIGHT 114-151009	SHEET 3 OF 3
	ANGLES ±0°30'00"		REV B
MATERIAL 3	FINISH	CUSTOMER DRAWING	