

REVISIONS

P	LTR	DESCRIPTION	DATE	DWN	APVD
	A	INITIAL RELEASE	17JUN2020	J.G	I.Y
	A1	ECR-20-010349	26JUL2020	J.G	I.Y
	A2	ECN-21-113425	17AUG2021	J.G	Z.Z

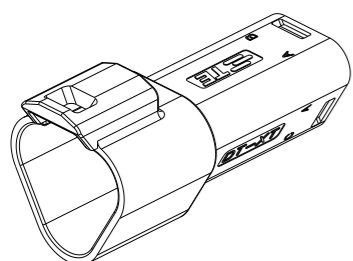

3CCT RECEPTACLE CONNECTOR WITHOUT HEATSHRINK HOUSING

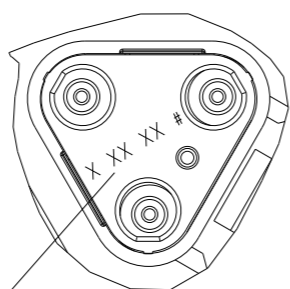

DETAIL A SCALE 2:1

4 DATE CODE: X XX XX
 X- DAY: 1- 7
 XX- WEEK: 01 - 52
 XX- YEAR: 00 - 99
 #- MACHINE NO. 1

EXAMPLE: 11315 = DAY 1, WEEK 13, YEAR 15 i.e. 23rd OF MARCH 2015

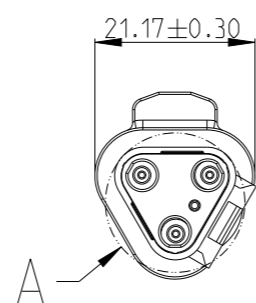
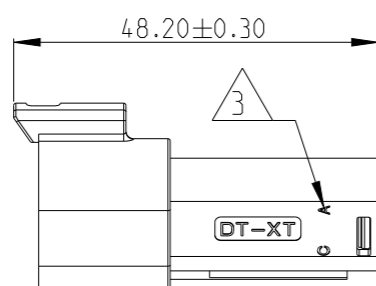
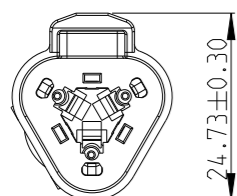

1. THIS RECEP MATES WITH PLUG ASSEMBLY PN X-2600027-X, WEDGE LOCK PN W3PX.

2. MATERIALS
 RECEPTACLE HOUSING: NYLON GF30, SEE PN TABLE FOR COLOUR
 BACK SEAL: SILICONE RUBBER
 BACK COVER: NYLON GF30, BLACK
 HEATSHRINK HOUSING: NYLON GF30, BLACK

3 CIRCUIT IDENTIFICATION

4 DATE CODE DESCRIPTION

5. JACKET RANGE LARGE = Ø2.23MM TO 3.68MM (SEAL COLOUR: LIGHT BLUE)
 JACKET RANGE SMALL = Ø1.20MM TO 3.05MM (SEAL COLOUR: BURNT ORANGE)

6. SEE SHEET 2 FOR FINAL PART NUMBER

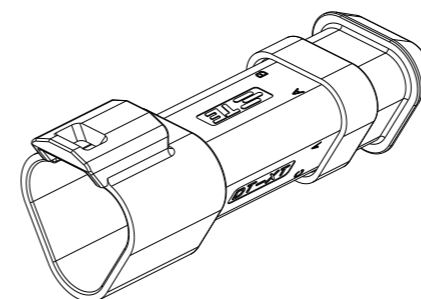

3CCT RECEPTACLE CONNECTOR WITH HEATSHRINK HOUSING ULTRASONICALLY WELDED IN PLACE

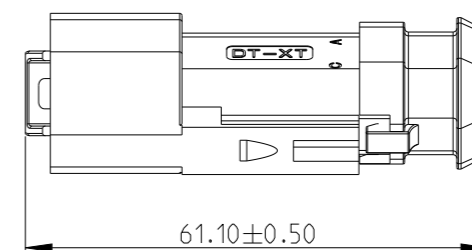
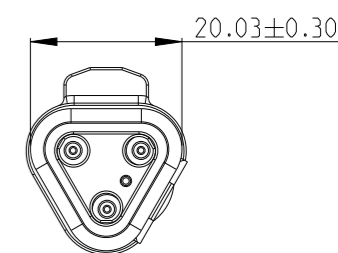
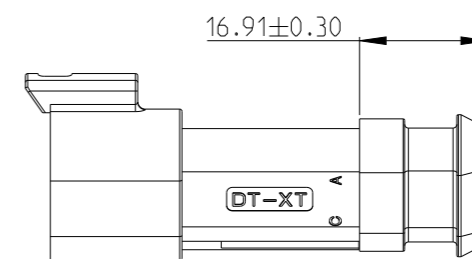
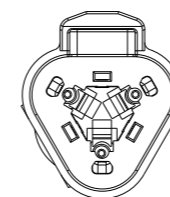

THIS DRAWING IS A CONTROLLED DOCUMENT.

DIMENSIONS:	TOLERANCES UNLESS OTHERWISE SPECIFIED:
mm	
	0 PLC ±
	1 PLC ±
	2 PLC ±
	3 PLC ±
	4 PLC ±
	ANGLES ±
MATERIAL	FINISH

DWN	J.GU	17JUN2020
CHK	E. JIANG	17JUN2020
APVD	I.YIN	17JUN2020
PRODUCT SPEC	108-160026	
APPLICATION SPEC	114-160017	
WEIGHT	-	

TE Connectivity		NAME	
		3CCT DT-XT CONNECTOR RECEPTACLE ASSEMBLY	
SIZE	CAGE CODE	DRAWING NO	RESTRICTED TO
A3	00779	C=2600026	-
CUSTOMER DRAWING;RESTRICTED CUSTOMER		SCALE 1:1	SHEET 1 OF 2 REV A2

THIS DRAWING IS UNPUBLISHED.

RELEASED FOR PUBLICATION

20

REVISIONS

© COPYRIGHT 2020 TE Connectivity. All Rights Reserved.

ALL RIGHTS RESERVED.

P	LTR	DESCRIPTION	DATE	DWN	APVD
		SEE SHEET 1			

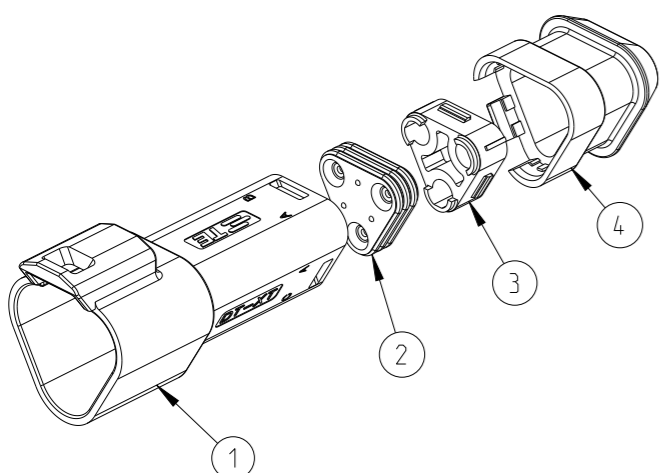

TE PN	ALIAS PN	REVISION OF EACH ASSY NO.	WEIGHT OF EACH ASSY(g)	COLOR	BLACK	GERY	GREEN	BLUE	YELLOW	WHITE	BROWN	ORANGE	RED	BURNT ORANGE	LIGHT BLUE	BLACK	BLACK	
2--0	934442609	-	8.923		-	-	-	-	-	-	-	-	1	-	1	1	1	
1--9	934442608	-	8.923		-	-	-	-	-	-	-	1	-	-	1	1	1	
1--8	934442607	-	8.923		-	-	-	-	-	1	-	-	-	-	1	1	1	
1--7	934442606	-	8.923		-	-	-	-	-	1	-	-	-	-	1	1	1	
1--6	934442605	-	8.923		-	-	-	1	-	-	-	-	-	-	1	1	1	
1--5	934442604	-	8.923		-	-	-	1	-	-	-	-	-	-	1	1	1	
1--4	934442603	-	8.923		-	-	1	-	-	-	-	-	-	-	1	1	1	
1--3	934442602	-	8.923		-	-	-	-	-	-	-	-	-	-	1	1	1	
1--2	934442601	-	8.923		-	-	-	-	-	-	-	-	-	-	1	1	1	
1--1	934442509	-	8.923		1	-	-	-	-	-	-	-	-	-	1	1	1	
1--0	934442508	-	8.923		-	-	-	-	-	-	-	1	1	-	1	1	1	
-9	934442507	-	8.923		-	-	-	-	-	-	1	-	-	1	-	1	1	
-8	934442506	-	8.923		-	-	-	-	-	1	-	-	-	1	-	1	1	
-7	934442505	-	8.923		-	-	-	1	-	-	-	-	-	1	-	1	1	
-6	934442504	-	8.923		-	-	1	-	-	-	-	-	-	1	-	1	1	
-5	934442503	-	8.923		-	-	1	-	-	-	-	-	-	1	-	1	1	
-4	934442502	-	8.923		-	-	1	-	-	-	-	-	-	1	-	1	1	
-3	934442501	-	8.923		1	-	-	-	-	-	-	-	-	1	-	1	1	
-2	934442209	-	6.88		-	-	-	-	-	-	-	1	-	1	-	1	-	
-1	934442208	-	6.88		-	-	-	-	-	-	1	-	-	1	-	1	-	
3--6	934442207	-	6.88		-	-	-	-	-	1	-	-	-	1	-	1	-	
3--5	934442206	-	6.88		-	-	-	-	1	-	-	-	-	1	-	1	-	
3--4	934442205	-	6.88		-	-	-	1	-	-	-	-	-	1	-	1	-	
3--3	934442204	-	6.88		-	-	1	-	-	-	-	-	-	1	-	1	-	
3--2	934442203	-	6.88		-	-	1	-	-	-	-	-	-	1	-	1	-	
3--1	934442202	-	6.88		-	1	-	-	-	-	-	-	-	1	-	1	-	
3--0	934442201	-	6.88		1	-	-	-	-	-	-	-	-	1	-	1	-	
2--9	934442109	-	6.88		-	-	-	-	-	-	-	1	1	-	1	1	-	
2--8	934442108	-	6.88		-	-	-	-	-	-	1	-	1	-	1	1	-	
2--7	934442107	-	6.88		-	-	-	-	-	1	-	-	1	-	1	1	-	
2--6	934442106	-	6.88		-	-	-	-	1	-	-	-	1	-	1	1	-	
2--5	934442105	-	6.88		-	-	-	1	-	-	-	-	1	-	1	1	-	
2--4	934442104	-	6.88		-	-	1	-	-	-	-	-	1	-	1	1	-	
2--3	934442103	-	6.88		-	-	1	-	-	-	-	-	1	-	1	1	-	
2--2	934442102	-	6.88		-	1	-	-	-	-	-	-	1	-	1	1	-	
2--1	934442101	-	6.88		1	-	-	-	-	-	-	-	1	-	1	1	-	
				DESCRIPTION	RECEPTACLE HOUSING										BACK SEAL SMALL	BACK SEAL LARGE	BACK COVER	HEATSHRINK HOUSING
				ITEM NO	1										2		3	4

THIS DRAWING IS A CONTROLLED DOCUMENT.

DWN J.GU 17 JUN 2020
 CHK E. JIANG 17 JUN 2020
 APVD L.YIN 17 JUN 2020

TE Connectivity

NAME 3CCT DT-XT CONNECTOR RECEPTACLE ASSEMBLY

PRODUCT SPEC 108-160026
 APPLICATION SPEC 114-160017

SIZE A3 CAGE CODE 00779 DRAWING NO C-2600026 RESTRICTED TO -

WEIGHT -

CUSTOMER DRAWING; RESTRICTED CUSTOMER SCALE 1:1 SHEET 2 OF 2 REV A2

DIMENSIONS:	TOLERANCES UNLESS OTHERWISE SPECIFIED:
mm	
	0 PLC ±
	1 PLC ±
	2 PLC ±
	3 PLC ±
	4 PLC ±
ANGLES	±
FINISH	-