

THIS DRAWING IS UNPUBLISHED. RELEASED FOR PUBLICATION 20
 © COPYRIGHT 20 BY - ALL RIGHTS RESERVED.

REVISIONS				
P	LTR	DESCRIPTION	DATE	APVD
A		REVISED PER ECR-19-012197	02AUG2019	NN DZ

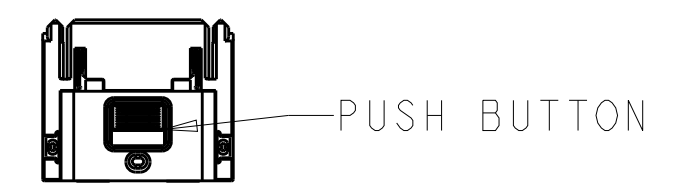
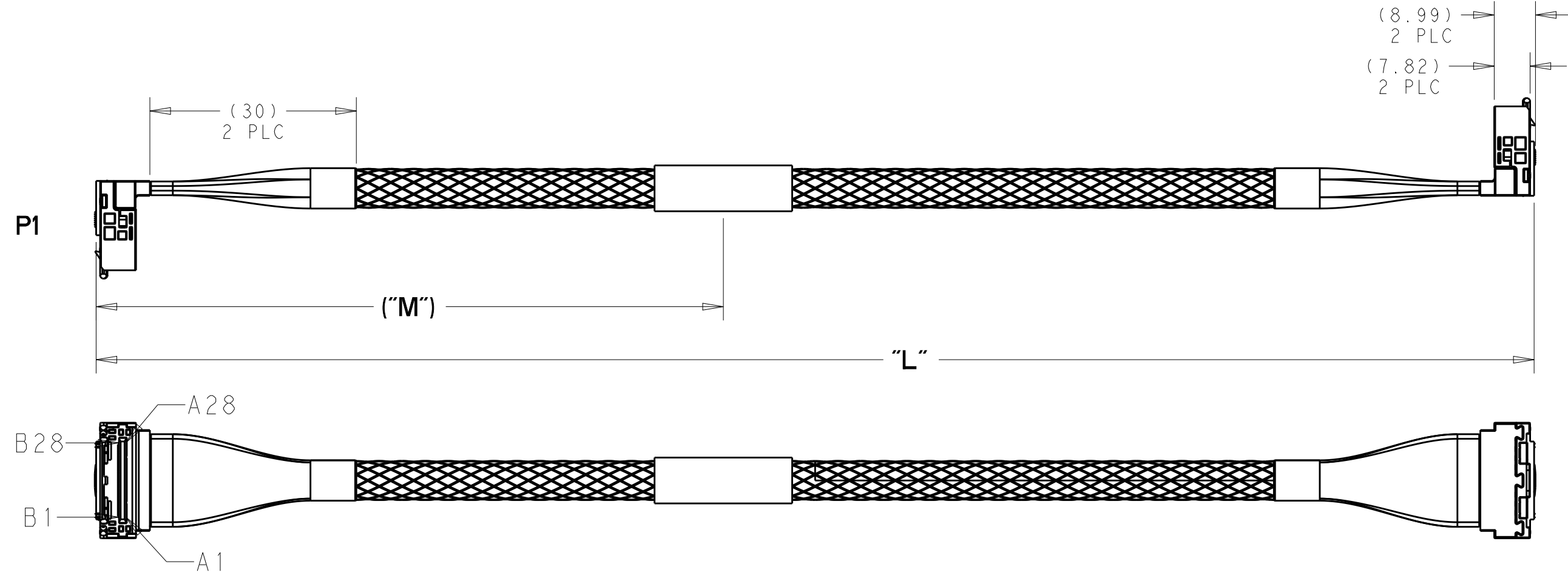
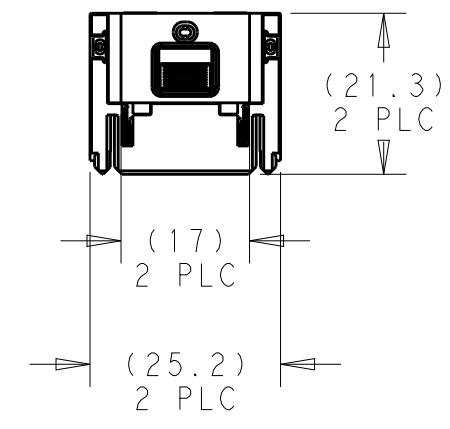
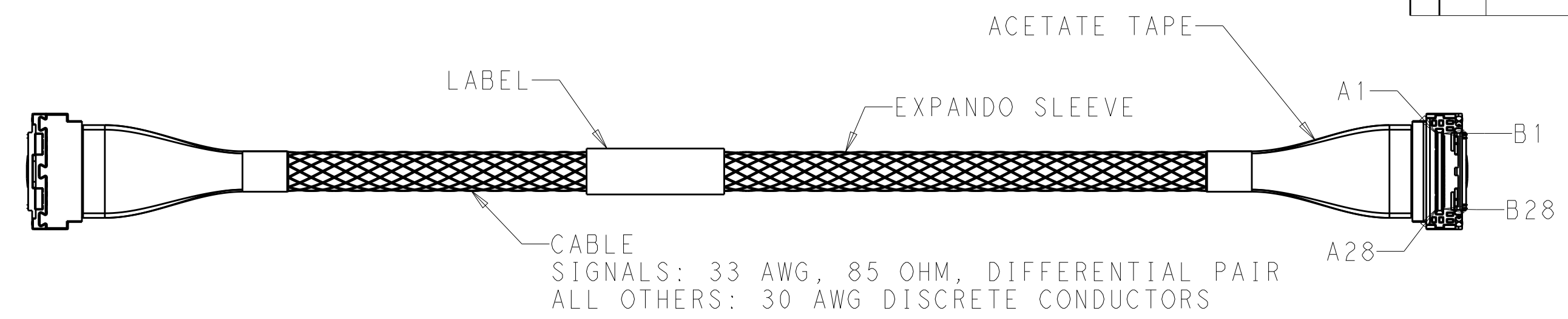

1. ALL MATERIALS, COMPONENTS AND PROCESS SHALL COMPLY WITH TEC-138-702. (CONTAINS NO BANNED OR RESTRICTED SUBSTANCES).
2. NO REACH SvHC SHALL BE CONTAINED ABOVE THE THRESHOLD AS DEFINED IN REACH SvHC COMPLIANCE DEFINITION IN ANNEX A OF TEC-138-702.
3. ASSEMBLY TESTED FOR CONTINUITY, OPENS, SHORTS, AND SIGNAL INTEGRITY.
4. CABLE BEND RADIUS 5X BUNDLED CABLE OD.
5. SEE SHEET 2 AND 3 FOR WIRING SCHEMATIC.
6. CONNECTORS ARE GEN-Z COMPLIANT.

△ LABEL INFORMATION SHOWN BELOW:



8. CABLE CONNECTOR MATES WITH TE SLIVER RECEPTACLE P/N 2332141-X, OR 2332208-X.

500	1000 +10/-0	2340874-2
250	500 +10/-0	2340874-1
("M")	"L"	TE P/N

THIS DRAWING IS A CONTROLLED DOCUMENT.		DWN B. MATTHEWS 03AUG2018	TE Connectivity	
DIMENSIONS: mm		CHK G. GUTGOLD 03AUG2018		
TOLERANCES UNLESS OTHERWISE SPECIFIED:		APVD	NAME SLIVER 2.0 1C 33AWG RIGHT ANGLE TO RIGHT ANGLE	
0 PLC ±		PRODUCT SPEC	SIZE	
1 PLC ±0.5		APPLICATION SPEC	CAGE CODE	
2 PLC ±0.13		WEIGHT	DRAWING NO	
3 PLC ±0.013		CUSTOMER DRAWING	RESTRICTED TO	
4 PLC ±0.0001		SCALE 1:1	SHEET 1 OF 3	
ANGLES		REV A		
FINISH				

THIS DRAWING IS UNPUBLISHED. RELEASED FOR PUBLICATION 20
 © COPYRIGHT 20 BY - ALL RIGHTS RESERVED.

REVISIONS					
P	LTR	DESCRIPTION	DATE	DWN	APVD
-		SEE SHEET 1	-	-	-

PIN #	P1		WIRE TYPE	P2		
	PAIR #	DESIGNATION		DESIGNATION	PAIR #	PIN #
A1		GROUND	DISCRETE	GROUND		A1
A2		GROUND	DISCRETE	GROUND		A2
A3		GROUND	DISCRETE	GROUND		A3
A4		GROUND	DISCRETE	GROUND		A4
A5		GROUND	DISCRETE	GROUND		A5
A6		GROUND	DISCRETE	GROUND		A6
A7		SIDE BAND	DISCRETE	SIDE BAND		A7
A8		SIDE BAND	DISCRETE	SIDE BAND		A8
A9		SIDE BAND	DISCRETE	SIDE BAND		A9
A10		SIDE BAND	DISCRETE	SIDE BAND		A10
A11		SIDE BAND	DISCRETE	SIDE BAND		A11
A12		SIDE BAND	DISCRETE	SIDE BAND		A12
A13		GND		GND		A13
A14		CLK	DIFF PAIR	CLK		A14
A15		CLK	DIFF PAIR	CLK		A15
A16		GND		GND		A16
A17	0	PCIeTX	DIFF PAIR	PCIeTX	0	A17
A18	0	PCIe TX	DIFF PAIR	PCIe TX	0	A18
A19		GND		GND		A19
A20	1	PCIeTX	DIFF PAIR	PCIeTX	1	A20
A21	1	PCIe TX	DIFF PAIR	PCIe TX	1	A21
A22		GND		GND		A22
A23	2	PCIeTX	DIFF PAIR	PCIeTX	2	A23
A24	2	PCIe TX	DIFF PAIR	PCIe TX	2	A24
A25		GND		GND		A25
A26	3	PCIeTX	DIFF PAIR	PCIeTX	3	A26
A27	3	PCIe TX	DIFF PAIR	PCIe TX	3	A27
A28		GND		GND		A28

COMMONED

COMMONED

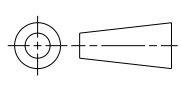
THIS DRAWING IS A CONTROLLED DOCUMENT.		DWN B. MATTHEWS 03AUG2018	 TE Connectivity	
DIMENSIONS: mm 		CHK G. GUTGOLD 03AUG2018		
TOLERANCES UNLESS OTHERWISE SPECIFIED: 0 PLC ± 1 PLC ±0.5 2 PLC ±0.13 3 PLC ±0.013 4 PLC ±0.0001 ANGLES ± FINISH -		APVD -	PRODUCT SPEC -	RESTRICTED TO -
MATERIAL -		APVD -	APPLICATION SPEC -	SCALE 1:1 SHEET 2 OF 3 REV A
		WEIGHT -	CUSTOMER DRAWING	SIZE A200779
			DRAWING NO C-2340874	

THIS DRAWING IS UNPUBLISHED. RELEASED FOR PUBLICATION 20
 © COPYRIGHT 20 BY - ALL RIGHTS RESERVED.

REVISIONS				
P	LTR	DESCRIPTION	DATE	APVD
-	-	SEE SHEET 1	-	-

PIN #	PAIR #	DESIGNATION	WIRE TYPE	P2		
				DESIGNATION	PAIR #	PIN #
B1		12V POWER	DISCRETE	12V POWER		B1
B2		12V POWER	DISCRETE	12V POWER		B2
B3		12V POWER	DISCRETE	12V POWER		B3
B4		12V POWER	DISCRETE	12V POWER		B4
B5		12V POWER	DISCRETE	12V POWER		B5
B6		12V POWER	DISCRETE	12V POWER		B6
B7		SIDE BAND	DISCRETE	SIDE BAND		B7
B8		SIDE BAND	DISCRETE	SIDE BAND		B8
B9		SIDE BAND	DISCRETE	SIDE BAND		B9
B10		SIDE BAND	DISCRETE	SIDE BAND		B10
B11		3.3 AUX POWER	DISCRETE	3.3 AUX POWER		B11
B12		SIDE BAND	DISCRETE	SIDE BAND		B12
B13		GND		GND		B13
B14		CLK	DIFF PAIR	CLK		B14
B15		CLK	DIFF PAIR	CLK		B15
B16		GND		GND		B16
B17	0	PCIeRX	DIFF PAIR	PCIeRX	0	B17
B18	0	PCIe RX	DIFF PAIR	PCIe RX	0	B18
B19		GND		GND		B19
B20	1	PCIeRX	DIFF PAIR	PCIeRX	1	B20
B21	1	PCIe RX	DIFF PAIR	PCIe RX	1	B21
B22		GND		GND		B22
B23	2	PCIeRX	DIFF PAIR	PCIeRX	2	B23
B24	2	PCIe RX	DIFF PAIR	PCIe RX	2	B24
B25		GND		GND		B25
B26	3	PCIeRX	DIFF PAIR	PCIeRX	3	B26
B27	3	PCIe RX	DIFF PAIR	PCIe RX	3	B27
B28		GND		GND		B28

COMMONED

COMMONED

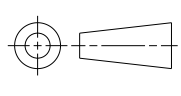
THIS DRAWING IS A CONTROLLED DOCUMENT.		DWN B. MATTHEWS 03AUG2018	 TE Connectivity	
DIMENSIONS: mm		CHK G. GUTGOLD 03AUG2018		
		TOLERANCES UNLESS OTHERWISE SPECIFIED: 0 PLC ±- 1 PLC ±0.5 2 PLC ±0.13 3 PLC ±0.013 4 PLC ±0.001 ANGLES ±- FINISH -		NAME SLIVER 2.0 1C 33AWG RIGHT ANGLE TO RIGHT ANGLE
MATERIAL		APVD	PRODUCT SPEC	RESTRICTED TO
		APPLICATION SPEC	SCALE 1:1	SHEET 3 OF 3
		WEIGHT	DRAWING NO. A200779	REV A
		CUSTOMER DRAWING	DRAWING NO. C-2340874	