

REVISIONS				
P	LTR	DESCRIPTION	DATE	APVD
	A	PRODUCT RELEASE	23JUL2018	M. J E. I

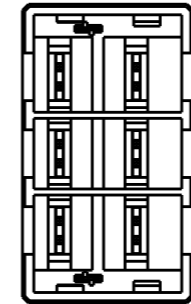

1-2326092-2 (KEYING:XX)

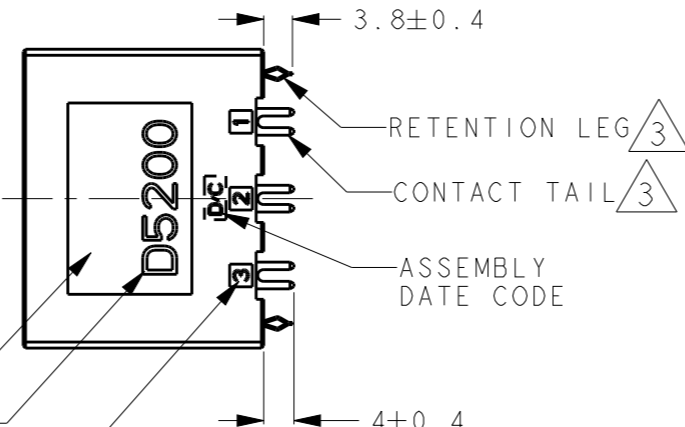
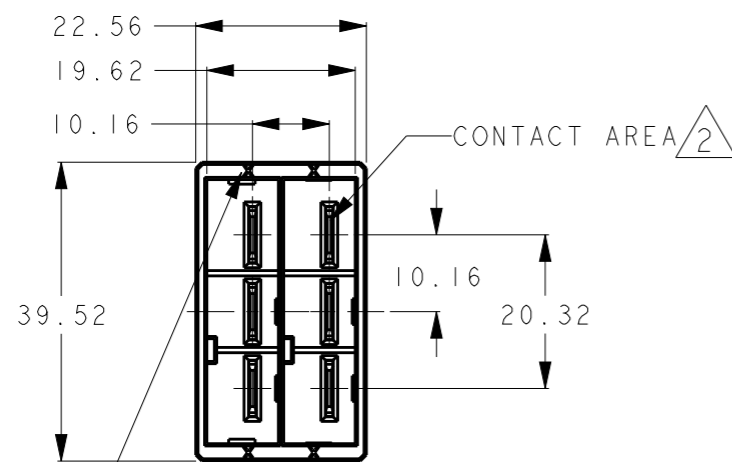
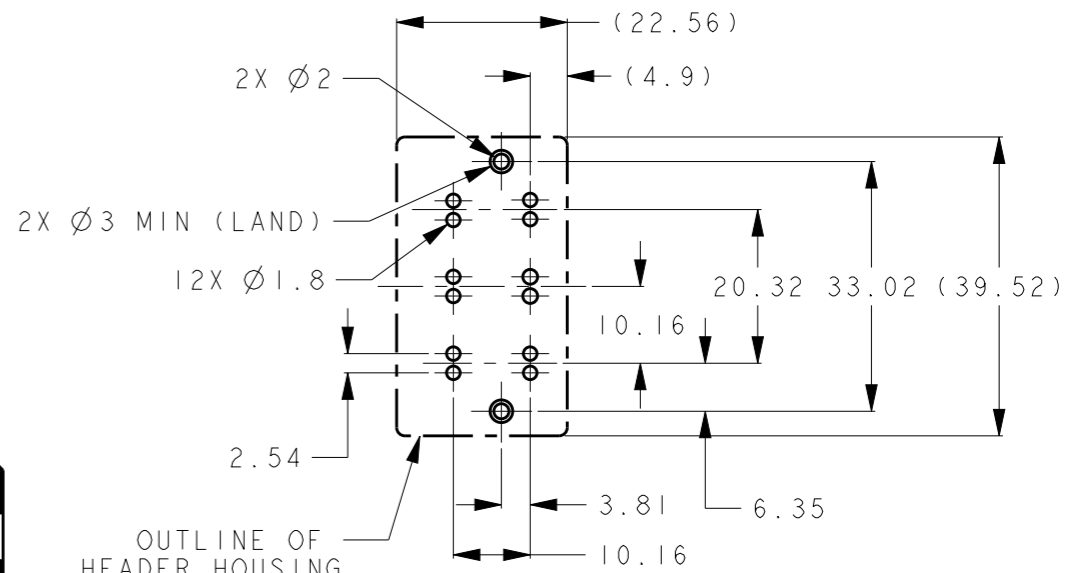
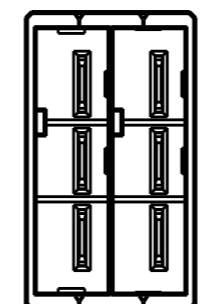
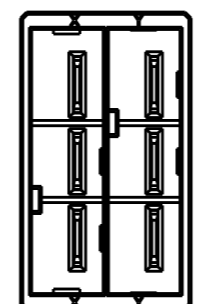
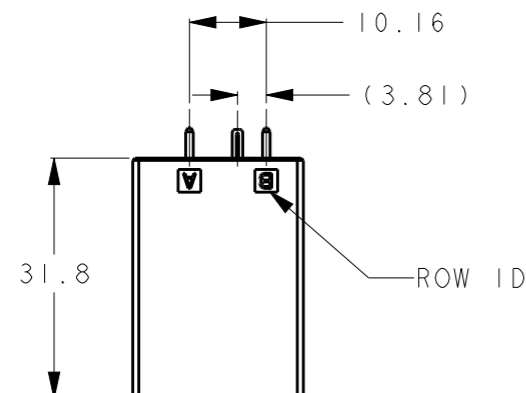
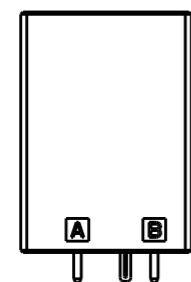

RECOMMENDED PCB HOLE PATTERN (TOLERANCE: ±0.05)
 RECOMMENDED PCB THICKNESS: 1.6~2.4±0.1 (CONNECTOR MOUNT SIDE)

XY	2 3	3-2326092-2
YY	2 3	2-2326092-2
XX	2 3	1-2326092-2
KEY TYPE	FINISH	PART NO.

1. MATERIAL:
 HOUSING: GLASS FILLED THERMO PLASTICS, POLYESTER(94V-0),
 COLOR: BLACK.
 TAB CONTACT: COPPER ALLOY.
 RETENTION LEG: BRASS.

- 2. FINISH(CONTACT AREA): 0.38um MIN Au PLATING OVER Ni PLATING.
- 3. FINISH(CONTACT TAIL, RETENTION LEG): Sn PLATING OVER Ni PLATING.

THIS DRAWING IS A CONTROLLED DOCUMENT.		DWN M. JIANG 23JUL2018	TE Connectivity	
DIMENSIONS: mm		CHK T. SHIMOYASU 23JUL2018		
TOLERANCES UNLESS OTHERWISE SPECIFIED:		APVD F. IKEMATSU 23JUL2018	NAME VERTICAL HDR, DOUBLE ROW, 6 POS DYNAMIC D5200	
0 PLC ±0.3 1 PLC ±0.3 2 PLC ±0.3 3 PLC ±0.3 4 PLC ±0.3 ANGLES ±3°		PRODUCT SPEC 108-5453	RESTRICTED TO	
MATERIAL SEE NOTE		APPLICATION SPEC -	SIZE A300779	DRAWING NO C-2326092
FINISH SEE NOTE		WEIGHT -	SCALE 1:1	REV A
		CUSTOMER DRAWING	SHEET 1	OF 1