

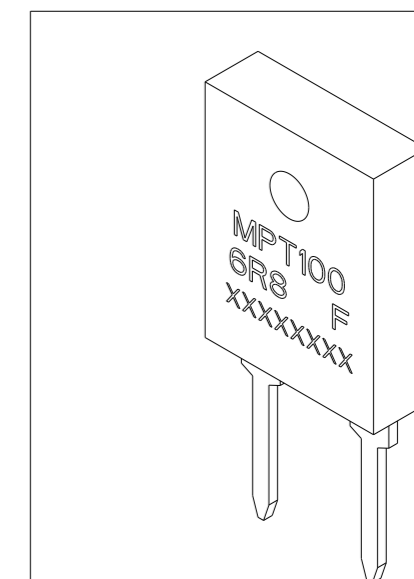

P	LTR	DESCRIPTION	DATE	DWN	APVD
	BA	INITIAL RELEASE	24JUL2019	SR	AP
	BA1	SCHEDULE ADDED TO DRAWING	11OCT2022	DM	AP
	BA2	DRAWING SCHEDULE UPDATED	22NOV2022	DM	AP

FOR FURTHER INFORMATION SEE DATA SHEET FOR MPT SERIES-THICK FILM POWER RESISTORS

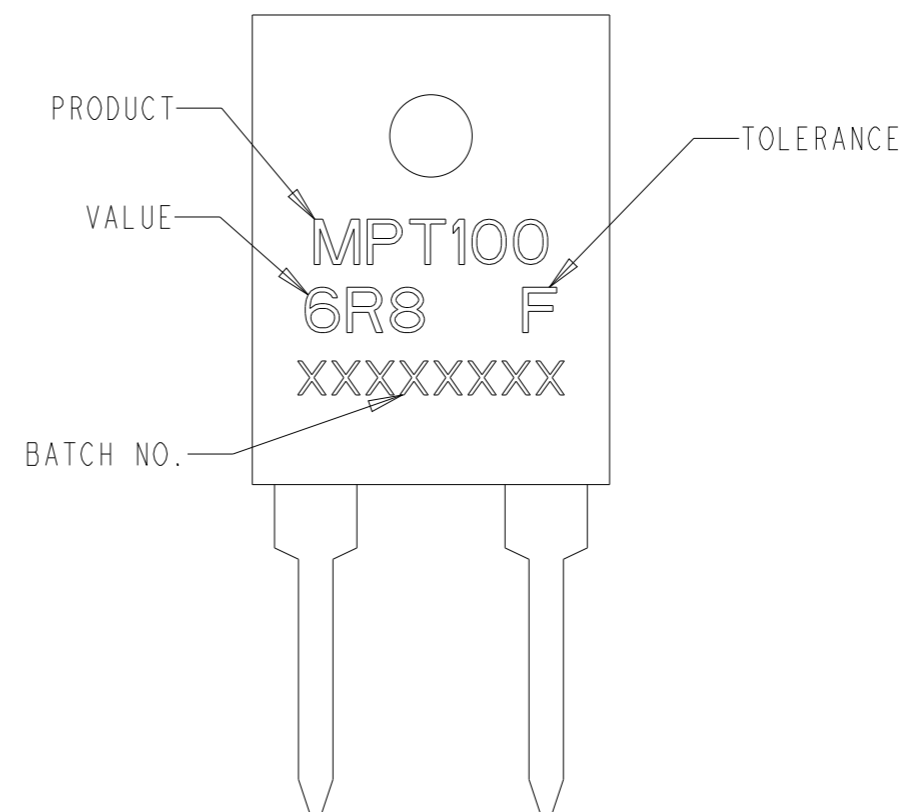
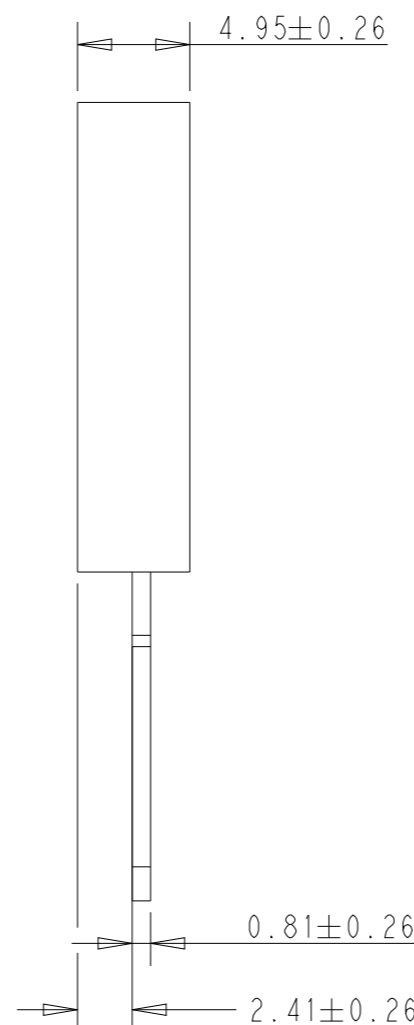
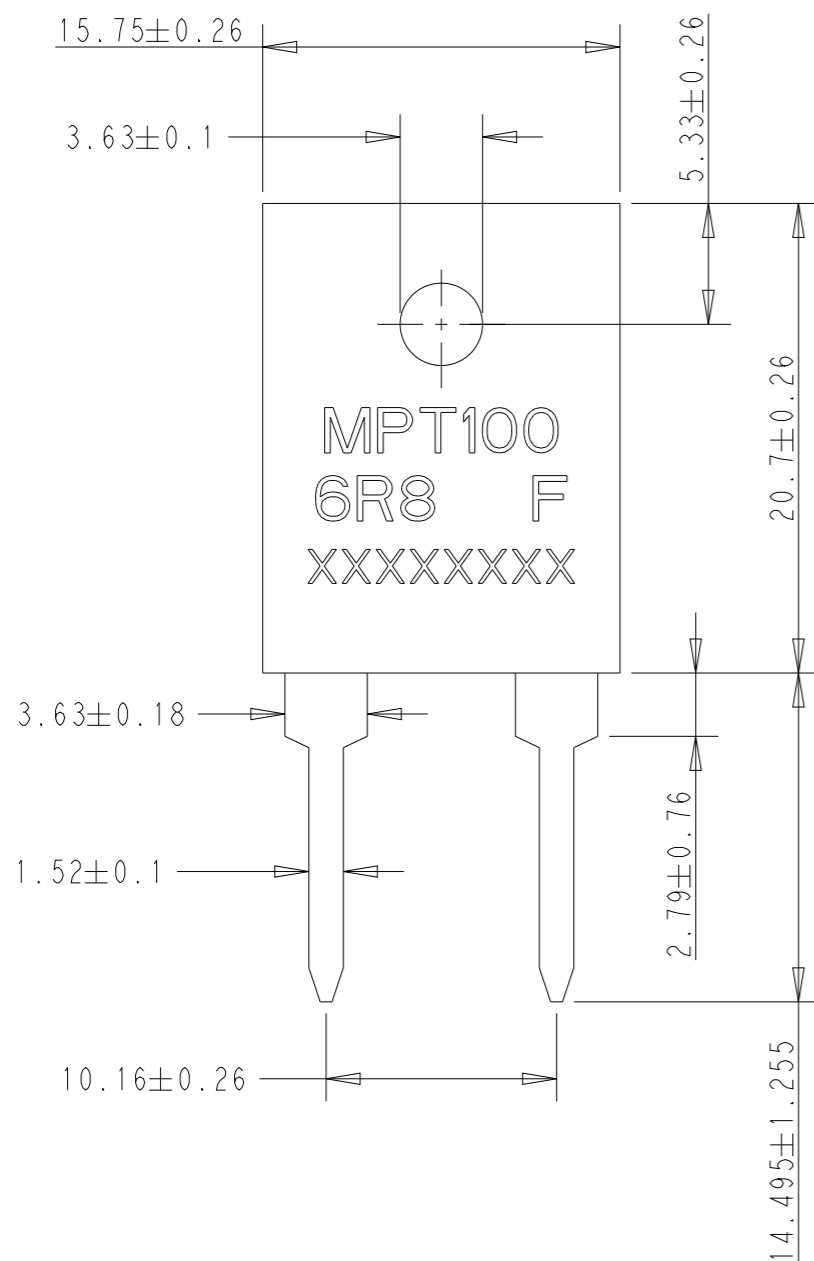

THIS DRAWING IS A CONTROLLED DOCUMENT.		DWN SUPREETH R 24JUL2019	 SCALE 2:1 TE Connectivity	
DIMENSIONS: mm		CHK A. PILE 24JUL2019		
TOLERANCES UNLESS OTHERWISE SPECIFIED:		APVD A. PILE 24JUL2019	NAME THICK FILM POWER RESISTOR TYPE MPT100 SERIES	
0 PLC ±- 1 PLC ±- 2 PLC ±- 3 PLC ±- 4 PLC ±- ANGLES ±-		PRODUCT SPEC -	SIZE A3 CAGE CODE 00779 DRAWING NO. C-2176429 RESTRICTED TO -	
MATERIAL -		APPLICATION SPEC -	SCALE 3:1 SHEET 1 OF 3 REV BA2	
FINISH -		WEIGHT -	CUSTOMER DRAWING	

REVISIONS

P	LTR	DESCRIPTION	DATE	DWN	APVD
	-	SEE SHEET 1	-	-	-

SCHEDULE

TCPN	CATALOGUE NUMBER	PART DESCRIPTION	PART STATUS
2176429-1	MPT100XR10J	MPT100 R10 5%	PRODUCTION
2176429-2	MPT100XR15J	MPT100 R15 5%	PRODUCTION
2176429-3	MPT100XR22J	MPT100 R22 5%	PRODUCTION
2176429-4	MPT100XR33J	MPT100 R33 5%	PRODUCTION
2176429-5	MPT100XR47J	MPT100 R47 5%	PRODUCTION
2176429-6	MPT100XR68J	MPT100 R68 5%	PRODUCTION
2176429-7	MPT100X1R0J	MPT100 1R0 5%	PRODUCTION
2176429-8	MPT100T1R5J	MPT100 1R5 5%	PRODUCTION
2176429-9	MPT100T2R2J	MPT100 2R2 5%	PRODUCTION
1-2176429-0	MPT100A3R3J	MPT100 3R3 5%	PRODUCTION
1-2176429-1	MPT100A4R7J	MPT100 4R7 5%	PRODUCTION
1-2176429-2	MPT100A6R8J	MPT100 6R8 5%	PRODUCTION
1-2176429-3	MPT100A10RJ	MPT100 10R 5%	PRODUCTION
1-2176429-4	MPT100C15RJ	MPT100 15R 5%	PRODUCTION
1-2176429-5	MPT100C22RJ	MPT100 22R 5%	PRODUCTION
1-2176429-6	MPT100C33RJ	MPT100 33R 5%	PRODUCTION
1-2176429-7	MPT100C47RJ	MPT100 47R 5%	PRODUCTION
1-2176429-8	MPT100C68RJ	MPT100 68R 5%	PRODUCTION
1-2176429-9	MPT100C100RJ	MPT100 100R 5%	PRODUCTION
2-2176429-0	MPT100C150RJ	MPT100 150R 5%	PRODUCTION
2-2176429-1	MPT100C220RJ	MPT100 220R 5%	PRODUCTION
2-2176429-2	MPT100C330RJ	MPT100 330R 5%	PRODUCTION
2-2176429-3	MPT100C470RJ	MPT100 470R 5%	PRODUCTION
2-2176429-4	MPT100C680RJ	MPT100 680R 5%	PRODUCTION
2-2176429-5	MPT100C1K0J	MPT100 1K0 5%	PRODUCTION
2-2176429-6	MPT100C1K5J	MPT100 1K5 5%	PRODUCTION
2-2176429-7	MPT100C2K2J	MPT100 2K2 5%	PRODUCTION
2-2176429-8	MPT100C3K3J	MPT100 3K3 5%	PRODUCTION
2-2176429-9	MPT100C4K7J	MPT100 4K7 5%	PRODUCTION
3-2176429-0	MPT100C6K8J	MPT100 6K8 5%	PRODUCTION

TCPN	CATALOGUE NUMBER	PART DESCRIPTION	PART STATUS
3-2176429-1	MPT100C10KJ	MPT100 10K 5%	PRODUCTION
3-2176429-2	MPT100T1R2F	MPT100 1R2 1%	PRODUCTION
3-2176429-3	MPT100T1R5F	MPT100 1R5 1%	PRODUCTION
3-2176429-4	MPT100T1R8F	MPT100 1R8 1%	PRODUCTION
3-2176429-5	MPT100T2R2F	MPT100 2R2 1%	PRODUCTION
3-2176429-6	MPT100T2R7F	MPT100 2R7 1%	PRODUCTION
3-2176429-7	MPT100A3R3F	MPT100 3R3 1%	PRODUCTION
3-2176429-8	MPT100A3R9F	MPT100 3R9 1%	PRODUCTION
3-2176429-9	MPT100A4R7F	MPT100 4R7 1%	PRODUCTION
4-2176429-0	MPT100A5R6F	MPT100 5R6 1%	PRODUCTION
4-2176429-1	MPT100A6R8F	MPT100 6R8 1%	PRODUCTION
4-2176429-2	MPT100A8R2F	MPT100 8R2 1%	PRODUCTION
4-2176429-3	MPT100A10RF	MPT100 10R 1%	PRODUCTION
4-2176429-4	MPT100C12RF	MPT100 12R 1%	PRODUCTION
4-2176429-5	MPT100C15RF	MPT100 15R 1%	PRODUCTION
4-2176429-6	MPT100C18RF	MPT100 18R 1%	PRODUCTION
4-2176429-7	MPT100C22RF	MPT100 22R 1%	PRODUCTION
4-2176429-8	MPT100C27RF	MPT100 27R 1%	PRODUCTION
4-2176429-9	MPT100C33RF	MPT100 33R 1%	PRODUCTION
5-2176429-0	MPT100C39RF	MPT100 39R 1%	PRODUCTION
5-2176429-1	MPT100C47RF	MPT100 47R 1%	PRODUCTION
5-2176429-2	MPT100C56RF	MPT100 56R 1%	PRODUCTION
5-2176429-3	MPT100C68RF	MPT100 68R 1%	PRODUCTION
5-2176429-4	MPT100C82RF	MPT100 82R 1%	PRODUCTION
5-2176429-5	MPT100C100RF	MPT100 100R 1%	PRODUCTION
5-2176429-6	MPT100C120RF	MPT100 120R 1%	PRODUCTION
5-2176429-7	MPT100C150RF	MPT100 150R 1%	PRODUCTION
5-2176429-8	MPT100C180RF	MPT100 180R 1%	PRODUCTION
5-2176429-9	MPT100C220RF	MPT100 220R 1%	PRODUCTION
6-2176429-0	MPT100C270RF	MPT100 270R 1%	PRODUCTION

THIS DRAWING IS A CONTROLLED DOCUMENT.

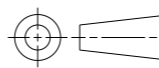
DIMENSIONS: mm	TOLERANCES UNLESS OTHERWISE SPECIFIED:
	0 PLC ±-
	1 PLC ±-
	2 PLC ±-
	3 PLC ±-
	4 PLC ±-
	ANGLES ±-
MATERIAL	FINISH
-	-
-	-

DWN	24JUL2019
SUPREETH R	
CHK	24JUL2019
A. PILE	
APVD	24JUL2019
A. PILE	
PRODUCT SPEC	-
APPLICATION SPEC	-
WEIGHT	-
CUSTOMER DRAWING	

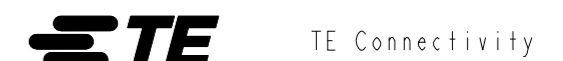

THICK FILM POWER RESISTOR
TYPE MPT100 SERIES

NAME	SIZE	CAGE CODE	DRAWING NO	RESTRICTED TO
-	A3	00779	©-2176429	-
SCALE	SHEET	OF	REV	
3:1	2	3	BA2	

REVISIONS

P	LTR	DESCRIPTION	DATE	DWN	APVD
	-	SEE SHEET 1	-	-	-

TCPN	CATALOGUE NUMBER	PART DESCRIPTION	PART STATUS
6-2176429-1	MPT100C330RF	MPT100 330R 1%	PRODUCTION
6-2176429-2	MPT100C390RF	MPT100 390R 1%	PRODUCTION
6-2176429-3	MPT100C470RF	MPT100 470R 1%	PRODUCTION
6-2176429-4	MPT100C560RF	MPT100 560R 1%	PRODUCTION
6-2176429-5	MPT100C680RF	MPT100 680R 1%	PRODUCTION
6-2176429-6	MPT100C820RF	MPT100 820R 1%	PRODUCTION
6-2176429-7	MPT100C1K0F	MPT100 1K0 1%	PRODUCTION
6-2176429-8	MPT100C1K2F	MPT100 1K2 1%	PRODUCTION
6-2176429-9	MPT100C1K5F	MPT100 1K5 1%	PRODUCTION
7-2176429-0	MPT100C1K8F	MPT100 1K8 1%	PRODUCTION
7-2176429-1	MPT100C2K2F	MPT100 2K2 1%	PRODUCTION
7-2176429-2	MPT100C2K7F	MPT100 2K7 1%	PRODUCTION
7-2176429-3	MPT100C3K3F	MPT100 3K3 1%	PRODUCTION
7-2176429-4	MPT100C3K9F	MPT100 3K9 1%	PRODUCTION
7-2176429-5	MPT100C4K7F	MPT100 4K7 1%	PRODUCTION
7-2176429-6	MPT100C5K6F	MPT100 5K6 1%	PRODUCTION
7-2176429-7	MPT100C6K8F	MPT100 6K8 1%	PRODUCTION
7-2176429-8	MPT100C8K2F	MPT100 8K2 1%	PRODUCTION
7-2176429-9	MPT100C10KF	MPT100 10K 1%	PRODUCTION
8-2176429-0	MPT100C200RF	MPT100 200R 1%	DISCONTINUED
8-2176429-1	MPT100C200RF	MPT100 200R 1%	PRODUCTION

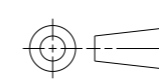
THIS DRAWING IS A CONTROLLED DOCUMENT.		DWN SUPREETH R 24JUL2019	 TE Connectivity		
DIMENSIONS: mm		CHK A. PILE 24JUL2019			
TOLERANCES UNLESS OTHERWISE SPECIFIED:		APVD A. PILE 24JUL2019	NAME THICK FILM POWER RESISTOR TYPE MPT100 SERIES		
		PRODUCT SPEC -	RESTRICTED TO -		
MATERIAL -		APPLICATION SPEC -	SIZE A3	CAGE CODE 00779	DRAWING NO C-2176429
FINISH -		WEIGHT -	SCALE 3:1		SHEET 3 OF 3
		CUSTOMER DRAWING		REV BA2	