

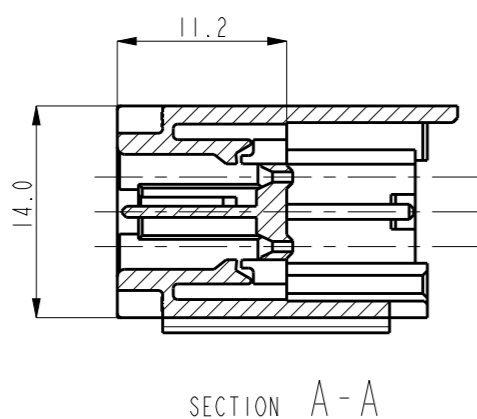

THIS DRAWING IS UNPUBLISHED. RELEASED FOR PUBLICATION 20  
 © COPYRIGHT 20 BY - ALL RIGHTS RESERVED.

LOC	DIST	REVISIONS			
P	LTR	DESCRIPTION	DATE	DWN	APVD
	E	ECR-19-010880	16JUL2019	SE	BH

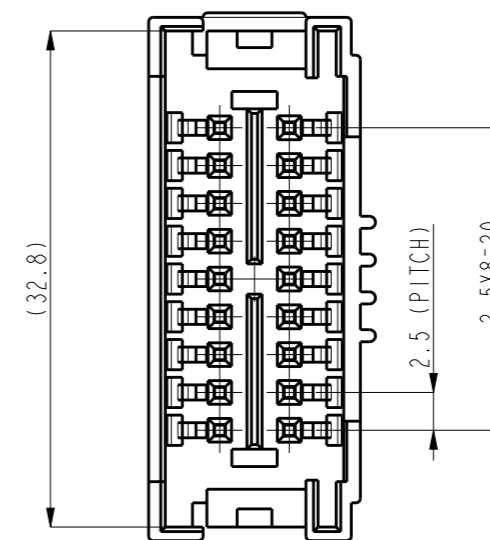
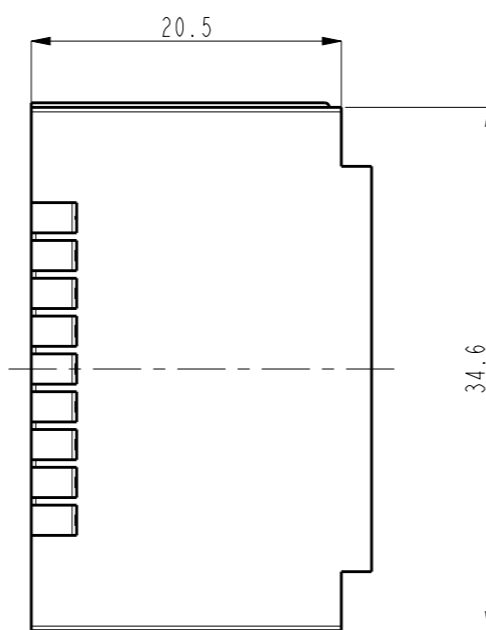
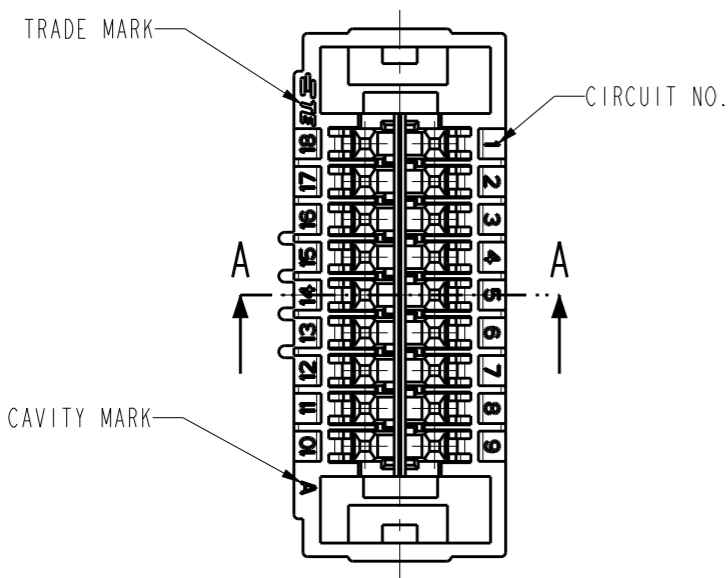
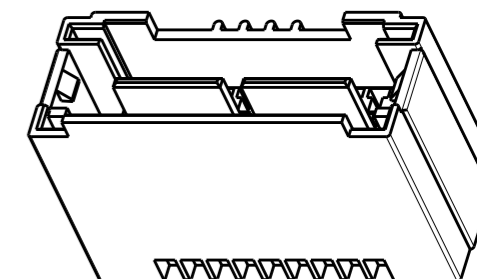
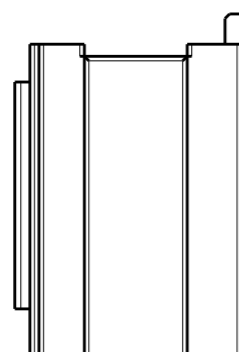

- NOTE
1. GENERAL TOLERANCES:  $\pm 0.25$
  2. MATING HSG P/N: 2108504-1
  3. APPLIED CONTACT P/N: 917764-X, 917765-X
  4. APPLIED TPA P/N: 917705-1
  5. MATERIAL: PA66 (UL94V-0)

2108505-1	NAT	18
P/N	COLOR	POS

THIS DRAWING IS A CONTROLLED DOCUMENT.		DWN	SE JUNG	 TE Connectivity		
DIMENSIONS: mm		CHK	BH CHO			
TOLERANCES UNLESS OTHERWISE SPECIFIED:		APVD	BW KANG	2.5 SDL 18P CAP HSG 2ROW TYPE		
0 PLC $\pm$		PRODUCT SPEC	108-61163	SIZE		
1 PLC $\pm 0.5$		APPLICATION SPEC	114-5203	CAGE CODE	DRAWING NO	RESTRICTED TO
2 PLC $\pm 0.13$		WEIGHT	-	A3	00779	C-2108505
3 PLC $\pm 0.013$		RESTRICTED CUSTOMER				SCALE
4 PLC $\pm 0.0001$						2:1
ANGLES $\pm$						SHEET
FINISH						1
MATERIAL SEE NOTE						OF
						1
						REV
						E