

4

3

2

1

THIS DRAWING IS UNPUBLISHED. RELEASED FOR PUBLICATION 20
© COPYRIGHT 20 BY TYCO ELECTRONICS CORPORATION. ALL RIGHTS RESERVED.

LOC	DIST	REVISIONS			
P	LTR	DESCRIPTION	DATE	DWN	APVD
DS	-	A	RELEASED	20,AUG'10	YG JK

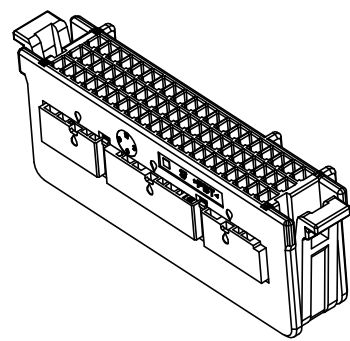

ISO VIEW

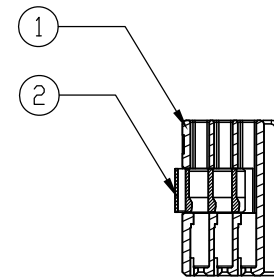
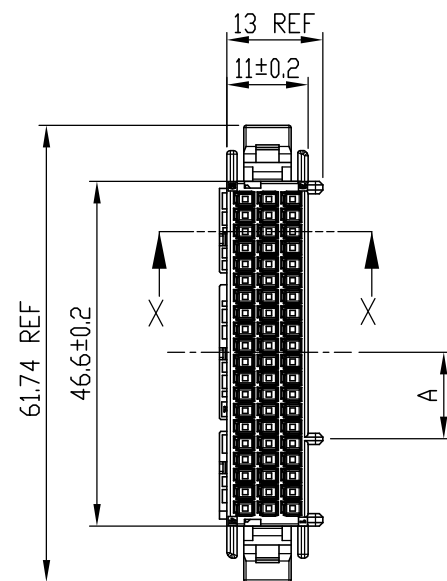

SECTION X-X
SCALE 1/1

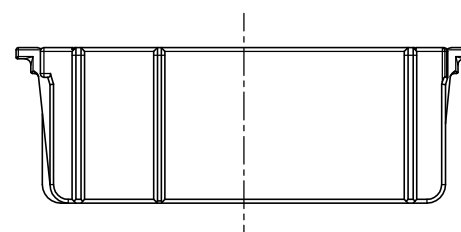
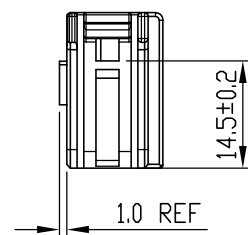
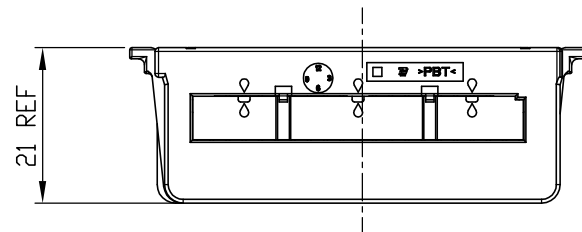

NOTE

1. APPLIED TERMINAL : SEE TABLE 1

TABLE 1

P/NO	FINISH	WIRE RANGE
2005097-1	PRE-TIN	CHFUS 0.13~0.22sq
2005427-1	PRE-TIN	AVSS 0.3~0.5sq

< KEY CODE >

P/NO	A (±0.2)
2005402-1	11.5
2005402-2	15.0
2005402-3	18.5

PLUG ASS'Y	2005402-3
PLUG ASS'Y	2005402-2
PLUG ASS'Y	2005402-1
DESCRIPTON	ASS'Y P/N

NO.	DESCRIPTION	PART NO.	FINISH/COLOR	Q'TY
②	DBL HSG	2005404-1	NATURAL	1 1 1
①	PLUG HSG	2005403-3	GRAY	- - 1
	PLUG HSG	2005403-2	BLACK	- 1 -
	PLUG HSG	2005403-1	NATURAL	1 - -

THIS DRAWING IS A CONTROLLED DOCUMENT FOR TYCO ELECTRONICS CORPORATION
IT IS SUBJECT TO CHANGE AND THE CONTROLLING ENGINEERING ORGANIZATION
SHOULD BE CONTACTED FOR THE LATEST REVISION.

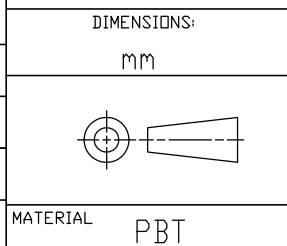

DIMENSIONS: mm
TOLERANCES UNLESS OTHERWISE SPECIFIED:
±0.3
ANGLES ±3°
MATERIAL PBT FINISH -

DWN YG PARK	Tyco Electronics Kyungsan, Korea	
CHK YJ YOUN	NAME	
APVD JK SONG	025 60P PLUG ASS'Y	
PRODUCT SPEC -	SIZE A3	CAGE CODE 00779
APPLICATION SPEC -	DRAWING NO C-2005402	RESTRICTED TO -
WEIGHT -	SCALE 1:1	SHEET 1 OF 1
CUSTOMER DRAWING	REV A	