

LOC J DIST

REVISIONS

変更

P	LTR	DESCRIPTION	DATE	DWN	APVD
	D	REVISED PER ECR-15-011723	08AUG2015	Y.O	E.T

ワイヤーレンジ
WIRE RANGE
ID MARK

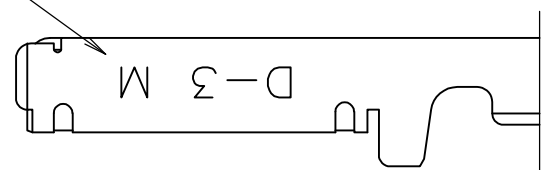

TOOLING ID MARK
ON OUTER SURFACE

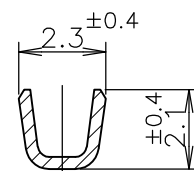

A-A

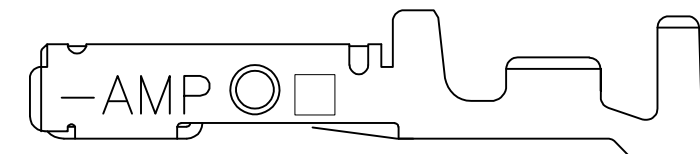
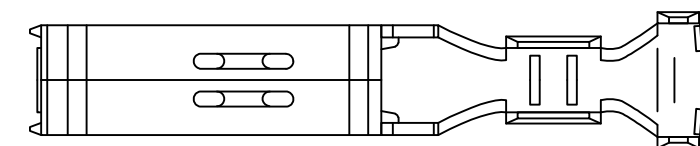

2-5 ONLY

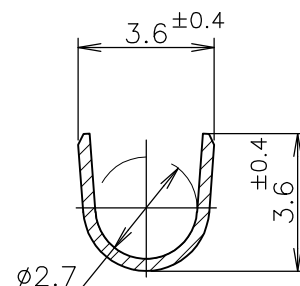
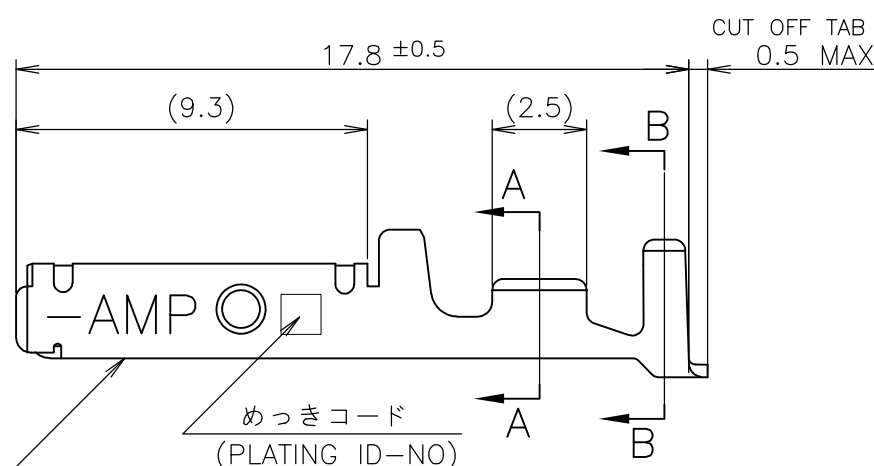
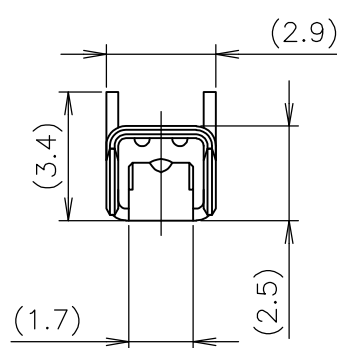

B-B

めっきコード
(PLATING ID-NO)
接圧表示
(PRESSURE ID-MARK)

- ① 標準接圧型コンタクト：一般向け及び多極用
- ② 高接圧型コンタクト：高電流用及び強振動用
- ③ 金めっきは接続部のみとする
- 4 製品規格：108-5349
- 5 取付け適用規格：114-5148

備考 (REMARK)	接圧表示 (ID-MARK)	めっきコード (PL. ID NO)	仕上 (FINISH)	型番 (P/N)	
OBSOLETE	H	5	光沢錫めっき (BRIGHT TIN-PL.)	2-175217-5	
		5	光沢錫めっき (BRIGHT TIN-PL.)	1-175217-5	
		3	0.76μm 最小金めっき (0.76μm MIN. Au-PL.)	1-175217-3	
	①	INACTIVE	2	0.38μm 最小金めっき (0.38μm MIN. Au-PL.)	1-175217-2
			5	光沢錫めっき (BRIGHT TIN-PL.)	175217-5
			3	0.76μm 最小金めっき (0.76μm MIN. Au-PL.)	175217-3
		2	0.38μm 最小金めっき (0.38μm MIN. Au-PL.)	175217-2	

- ① CONTACT TYPE; LOW PRESSURE TYPE (FOR GENERAL)
- ② CONTACT TYPE; HIGH PRESSURE TYPE (FOR HIGH CURRENT OR ANTI-VIBRATION)
- ③ GOLD-PL. CONTACT AREA ONLY
- 4 PRODUCT SPEC: 108-5349
- 5 APPLICATION SPEC: 114-5148

GENERAL TOLERANCE 一般公差
10 ≥ : ±0.2
30 ≥ > 10: ±0.25
100 ≥ > 30: ±0.3
ANGLES: ±3°

DIMENSIONS: 単位: 耗 mm		TOLERANCES UNLESS OTHERWISE SPECIFIED: 一般公差	
	0 PLC	±	-
	1 PLC	±	-
	2 PLC	±	-
	3 PLC	±	-
4 PLC	±	-	-
ANGLES		±	-
MATERIAL 材料 (COPPER ALLOY) 銅合金	FINISH 仕上 (SEE TABLE) 表参照		

THIS DRAWING IS A CONTROLLED DOCUMENT.		DWN T-YONEBAYASHI 27JUN1990
		CHK H.OBATA 14FEB1991
		APVD S.MANABE 14FEB1991
DIMENSIONS: 単位: 耗 mm		PRODUCT SPEC 製品規格
TOLERANCES UNLESS OTHERWISE SPECIFIED: 一般公差		APPLICATION SPEC 取付適用規格
MATERIAL 材料 (COPPER ALLOY) 銅合金		WEIGHT
FINISH 仕上 (SEE TABLE) 表参照		

WIRE RANGE 包合電線断面積 AWG 24-20 (0.2-0.5mmSQ) mm ²		INSULATION DIA 被覆外径 1.2-2.6 mmφ	
STE TE Connectivity			
M SIZE DYNAMIC SERIES REC. CONTACT L/P ダイナミックシリーズリセプタクルコンタクト L/P			
SIZE	CAGE CODE	DRAWING NO 番号	RESTRICTED TO
A3	00779	C-175217	
CUSTOMER DRAWING		SCALE 尺度 5:1	SHEET 1 OF 1
		REV D	