

NUMBER C-173985

METRIC 三角法 (3rd ANGLE PROJECTION)

METRIC

単位: 概 DIMENSIONS IN MM. DO NOT SCALE PRINT

PRINT DIST

4

3

2

1

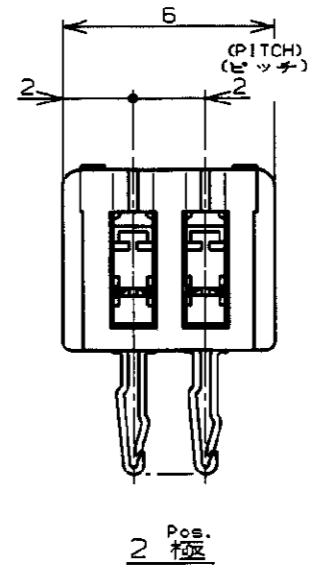
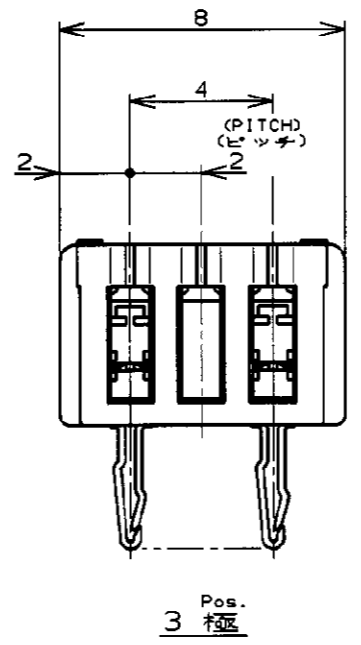
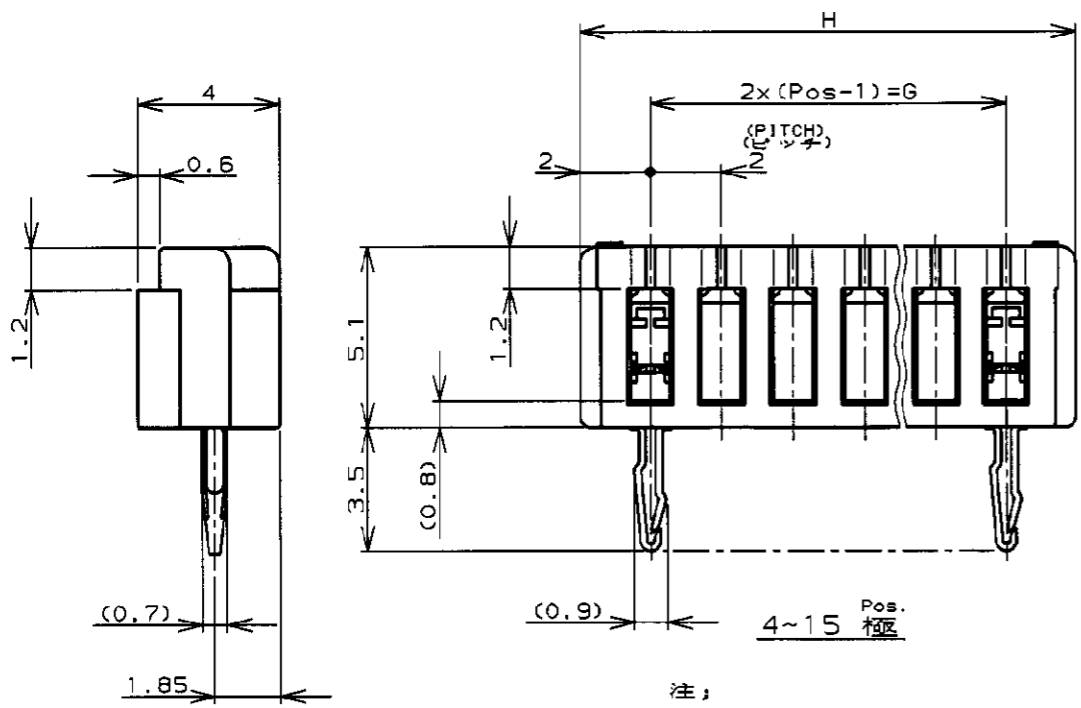
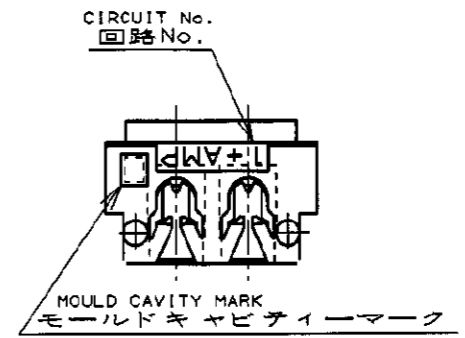
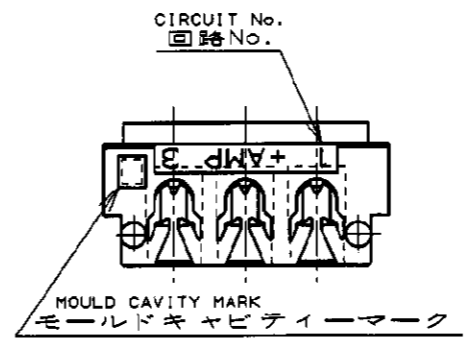
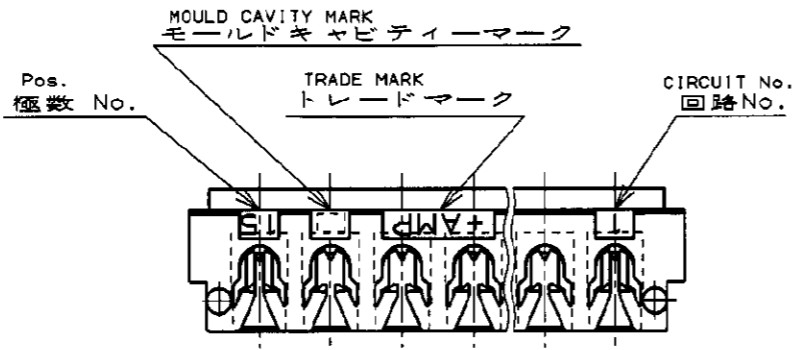

- 注;
1. 適用電線範囲 : AWG #28~26 (UL1571, UL1061)
被覆外径 : 0.83~10.5
(但し、使用電線について適合性に確認が必要です。)
 2. 材料 : ハウジング : ガラス入りP.B.T UL94V-0
コンタクト : 銅合金
 3. 適用製品規格番号 : 108-5217
 4. 取付適用規格番号 : 114-5103

- NOTES;
1. APPLICABLE WIRE SIZE : AWG #28~26 (UL1571, UL1061)
INSULATION DIA RANGE : 0.83~1.05
 2. MATERIAL :
HOUSING : P.B.T. (G.F)UL94V-0
CONTACT : COPPER ALLOY
 3. PRODUCT SPEC : 108-5217
 4. APPLICATION SPEC : 114-5103

3-173985-5	15	28	32
3-	-4	14	26 30
3-	-3	13	24 28
3-	-2	12	22 26
3-	-1	11	20 24
3-	-0	10	18 22
2-	-9	9	16 20
2-	-8	8	14 18
2-	-7	7	12 16
2-	-6	6	10 14
2-	-5	5	8 12
2-	-4	4	6 10
2-	-3	3	AS SHOWN 図示
2-173985-2	2	AS SHOWN 図示	
LIGHT BULE ライトブルー PART No. 製品型番	Pos. 極数	G	H

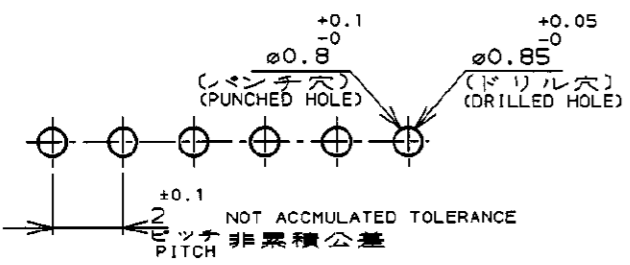

RECOMMENDABLE P.C. BOARD LAYOUT
推奨基板穴寸法
(適用基板厚0.8~1.6)
(P.C.B THK:0.8~1.6)

F2	REVISED PER ECR-21-114624	R.S	M.S	15DEC21
F1	REVISED PER ECO-11-005033	RK	HMR	2APR11
LTR	変更 (REVISION RECORD)	DR	CHK	DATE

組合電線断面積 (WIRE RANGE) NOTE 1 mm ² (AWG -) 材料 (MATERIAL) NOTE 2 DR. J. TSUJI 23/AUG/99 25 AUG 1999	被覆外径 (INSULATION DIA.) NOTE 1 mmφ 仕上 (FINISH) 一般公差 (GENERAL TOLERANCE) 10以下 : ±0.2 10を超え 30以下 : ±0.25 30を超え 100以下 : ±0.3 角 度 : ±3°	名称 (NAME) CT AMP-IN HEADER 2mm PITCH MT VERTICAL (V-TYPE) 一般公差 (GENERAL TOLERANCE) 10以下 : ±0.2 10を超え 30以下 : ±0.25 30を超え 100以下 : ±0.3 角 度 : ±3°	LOC B J 番号 (No.) C-173985
尺度 (SCALE) 5-1	REV. F2	SHEET 1 OF 1	寸法 (SCALE) 5-1