

THIS DRAWING IS UNPUBLISHED. VERTRAULICHE UNVERÖFFENTLICHTE ZEICHNUNG. RELEASED FOR PUBLICATION FREI FUER VERÖFFENTLICHUNG. MATED WITH: PASSEND ZU: BY AMP INCORPORATED. ALL RIGHTS RESERVED. ALLE RECHTE VORBEHALTEN. COPYRIGHT 1999

LOC	DIST	REVISIONS					
		P	LTR	DESCRIPTION	DATE	DWN	APVD
A1	-						
PROJEKT NR.: B902169		A		EG00 1710 99	13-Aug-99	SG	RJ
		A1		EG00 2466 99	16DEC1999	SG	RJ
		A2		EG00 0514 00	21FEB2000	CB	RJ
		A3		EG00 1882 00	17AUG2000	CB	TS

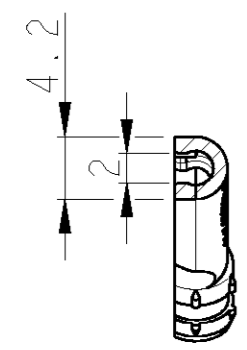

A-A

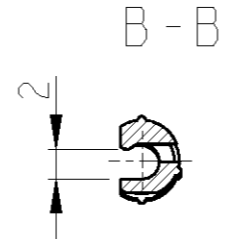
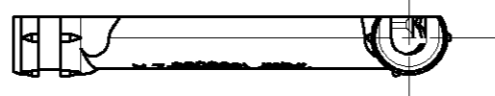

B-B

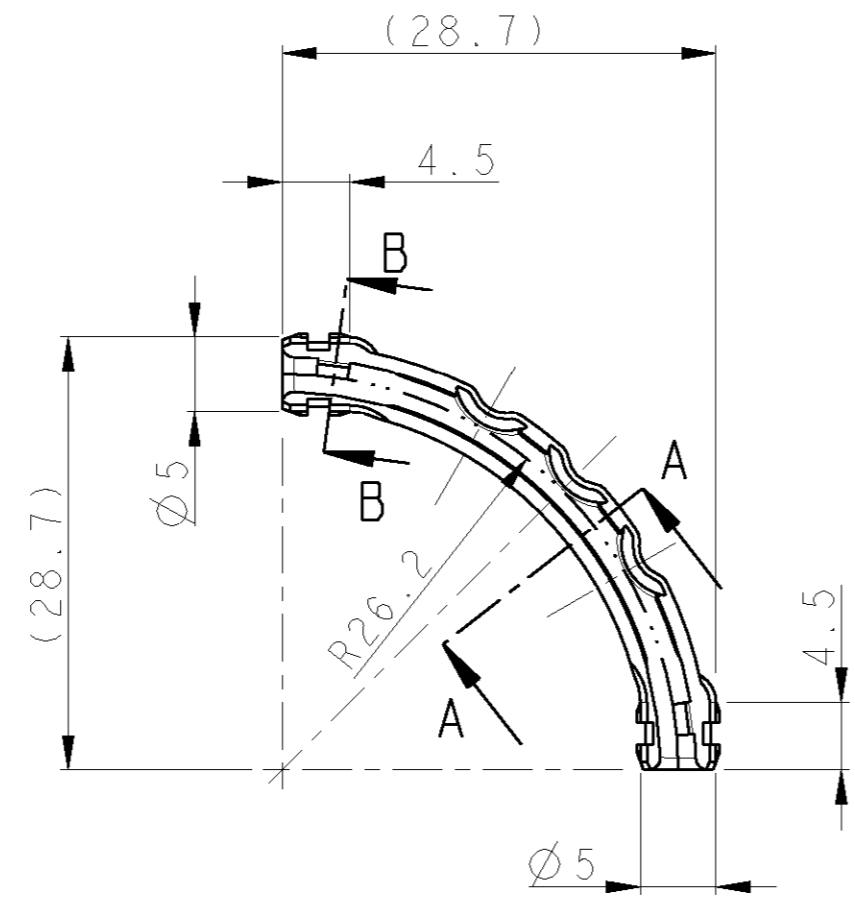
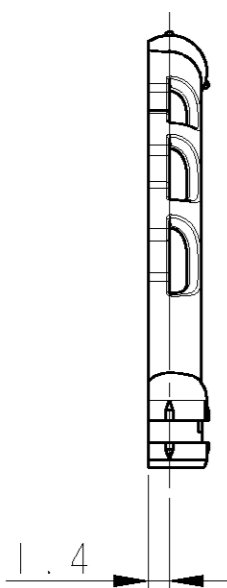

Material: PP-MF 20
 Farbe: bordeaux-violett
 COLOR: CLARET VIOLETT

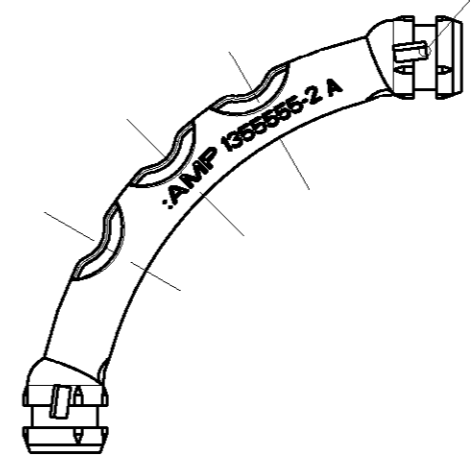

Bemerkungen
 NOTES

- 1 Einzelheiten der Ausfuehrung bleiben dem Hersteller ueberlassen
 DETAIL OF DESIGN ARE LEFT TO MANUFACTURER
- 2 Verpackung: Schuetttgut
 PACKING: LOOSE PIECE
- 3 Zulaessiger Regeneratanteil max. 25%
 RECYCLED MATERIAL MAX. 25% PERMITTED
- 4 Formteilungsgrat mac. 0.3 zulaessig
 MOULD BURRS MAX. 0.3 PERMITTED

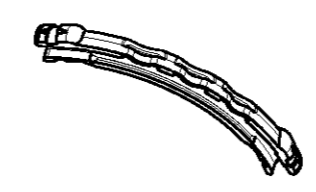

1:1

135555-2	A	bordeauxviolett CLARET VIOLETT
AMP BESTELL-NR. ORDER NO.	REV.	OBERFLAECHE SURFACE FARBE/COLOUR

<small>THIS DRAWING IS A CONTROLLED DOCUMENT FOR AMP INCORPORATED. IT IS SUBJECT TO CHANGE AND THE CONTROLLING ENGINEERING ORGANIZATION SHOULD BE CONTACTED FOR THE LATEST REVISION. DIESSES ZEICHNUNGSdokUMENT WIRD DURCH AMP INCORPORATED KONTROLLIERT. AENDERNUNGEN, DIE DEN TECHNISCHEN FORTSCHRITT DIESER, SIND VORBEHALTEN. DEN JEWEILS LETZTBESTEHENDEN AENDERUNGSSTAND ERFAEHREN SIE AUF ANFRAGE.</small>		DWN S. Garcia 31AUG99	AMP AMP Deutschland GmbH D - 63225 Langen	
DIMENSIONS: MASSEINHEITEN: mm		CHK R. Jetter 31AUG99	NAME STRAIN RELIEF FOR FIBER OPTIC CABLE Knickschutz fuer Lichtwellenleiter	
TOLERANCES UNLESS OTHERWISE SPECIFIED: ALLGEMEINTOLERANZEN 0 PLC ± 1 PLC ± 2 PLC ± DIN 3 PLC ± 16901-140 4 PLC ± ANGLES/WINKEL ±° FINISH/OBERFLAECHE/FARBE -		APVD -	PRODUCT SPEC PRODUKTSPEZ. 108-18698 APPLICATION SPEC VERARBEITUNGSSPEZ. 114-18351	
MATERIAL -		WEIGHT 1g	SIZE A2	RESTRICTED TO NUR FUER -
CUSTOMER DRAWING		SCALE MASSSTAB 2:1	SHEET BLATT 1	OF VON 1
		REV A3		