

Introduction



- 1 Custom 4-cavity receptacle shell
- 2 GPRB2 vertical shell & strain relief assembly
- 3 GPRB2 GAIN shell - with spring-loaded, floatmounting design
- 4 GPRB1 plug shell w/F12 ARINC 801 insert and termini installed

- 5 F12 ARINC 801 sleeve holder
- 6 Size 22 posted PC tail pin, Size 20 crimp pin, Size 5 Coax contacts
- 7 GPRB2 receptacle shell, with 30 & 40 position inserts installed
- 8 30 position insert with terminated Size 20 Pin contacts installed

- 9 Custom 40 position pin insert with PC tail contacts installed
- 10 GPRA plug shell assembly and 14M socket insert assembly
- 11 GPRA 14M pin insert assembly

This product is sold by TE under license from Radiall S.A.

Introduction

Product Facts

- **A high density solution compared to circular connectors**
 - Slim shell design with high contact density
 - Stackable shells that do not require additional space for locking and unlocking the connectors
 - Uses two to three times less space
- **A versatile solution suitable for disconnect panels or equipment with three mounting styles:**
 - Rack
 - Cable to cable
 - Panel mounting
- **A modular concept with a large variety of options**
 - Shell can accommodate a wide variety of inserts for signal, power, coax, data bus and fiber optic contacts
 - Optional grounding blocks (to meet FAA HIRF requirements)
 - Pin and socket inserts can be mounted on either plug or receptacle shells
- **A cost savings and user friendly solution**
 - Inserts can be wired in the shop and later installed in the shells
 - A common panel cut out eases the connector installation and reduces cost
 - Inserts can be easily installed and removed from the shell
 - Inserts and shells are keyed to prevent mismatching
 - Standard MIL tools for contact crimping and contact insertion/extraction
 - Field replaceable subassemblies
 - Vibration resistant self-locking threads

A Smart Connector

The General Purpose Rectangular A & B Series connectors complement our ARINC connectors and provide additional flexibility with improved performance in a smaller mating area compared to standard circular Mil-Spec connectors.

The GPRA and GPRB series offer a wide range of solutions based on two insert sizes, a large variety of shells and contacts. GPRA inserts are a good option for low density applications whereas GPRB inserts offer twice the density of GPRA inserts. In addition, the concept is completely modular and expandable.

They can also be easily tailored for custom requirements, such as shell modifications for additional inserts.

Technical Documents

Product Specification:

108-2398

Test Report:

501-734

New Features

Connector Interface

Connectors for Galley Insert (GAIN) Equipment:

- Page 8-32 lists the GPRB2 shells, insert arrangements, contacts, seal plugs, strain reliefs and cable that will be used, per ARINC 810. This is the standard connector interface for new galley equipment such as ovens and beverage makers for new commercial aircraft. This includes the twin-axial cable and contacts needed for the CANbus data bus system used for GAIN

Shells

GPRB1

- Shells have been improved to a greater level of performance under vibration. Also EMI performance has been maintained while eliminating the need for separate EMI springs.

Contacts

Size 22 Socket Contact with integral spring clip

An economy version socket contact is available for size 22 contacts and uses M39029 style interface.

Insert Arrangements

- New insert configurations for high speed data transmission - both fiber and quadrax
- GPRB - Fiber Optics
 - F12 - holds up to 12 ARINC 801 fiber optic termini (see page 8-24)
 - M2 - holds two 4-channel Mini-Expanded Beam inserts (see page 8-25)
- GPRB - Quadrax/Twinax
 - These size 8 quadrax contacts can be used in three insert arrangements - 10Q2, 25Q1 and 3Q3

These feature the exclusive TE one-piece dielectric that makes our quadrax and twinax contacts the easiest to install. If sealing is required with quadrax or twinax contacts, there is a size 8 seal boot assembly available (see page 8-30). Use of this seal boot provides 50,000 foot altitude immersion protection as tested per Boeing Spec BPS-C-179.

- GPRB - Power
 - These inserts all accommodate Size 5 Power Contacts - P3, 13P1, 20P1 and 25P1
- GPRB - Signal
 - Features 48 Size 22 contacts in a standard GPRB insert

Note:

Quadrax contacts available for use are listed in our Quadrax catalog #1654012.

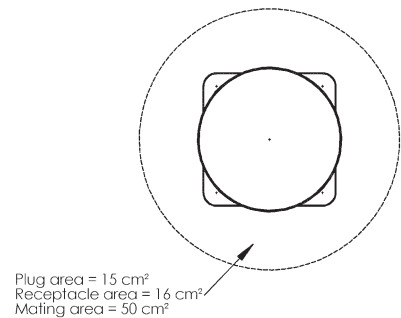
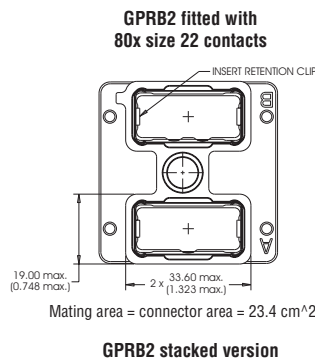
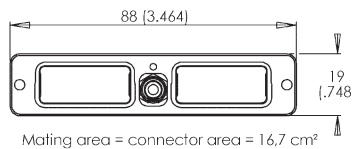

MIL-C-38999 21-35 fitted with 79x size 22 contacts

Introduction (Continued)

GPR A1

2 quarter-turn fasteners
 16 keying positions
 Max. density:
 20 x 22 contacts

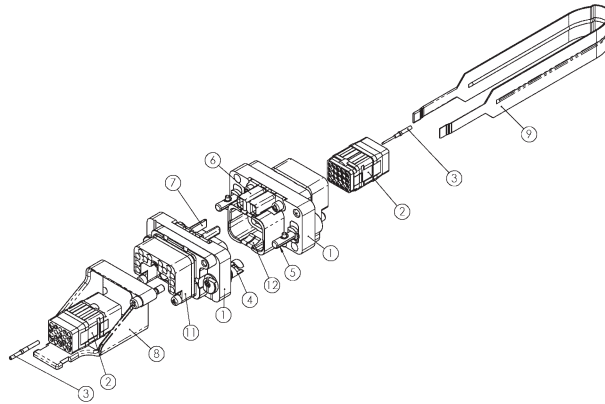

GPR B1

2 quarter-turn fasteners
 16 keying positions
 Max. density:
 40 x 22 contacts

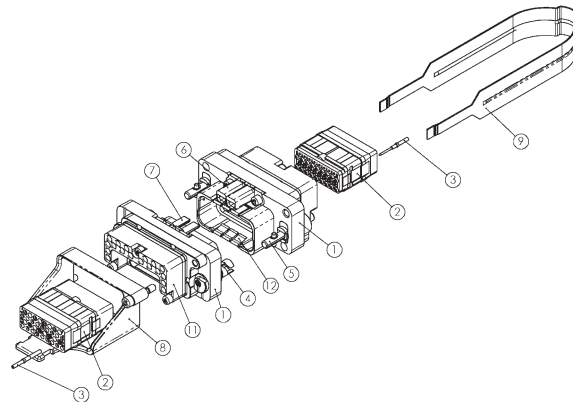

GPR B2

1 central jackscrew/jacknut
 12 keying positions
 Max. density:
 80 x 22 contacts

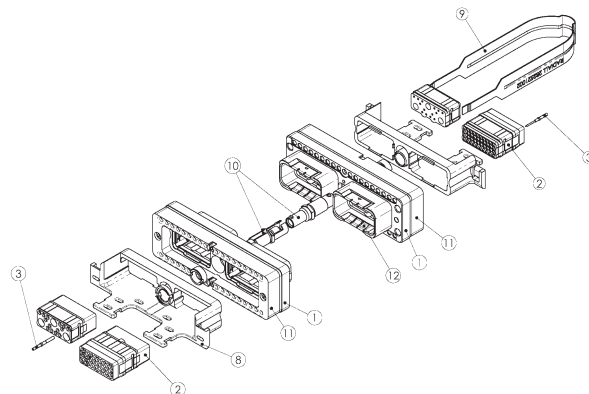

- | | |
|---------------------------|------------------------------------|
| ① shell | ⑧ backshell |
| ② insert | ⑨ insert insertion/extraction tool |
| ③ contact | ⑩ locking & polarization device |
| ④ & ⑤ locking device | ⑪ grounding block |
| ⑥ & ⑦ polarization device | ⑫ grounding springs |

Performance Characteristics

Contacts

Electrical characteristics conform to MIL-C-39029 Type A

Electrical Characteristics
Grounding Block Contact

	Contact with Wire Size	Current Amps
Contact to Contact	Contact + 20 AWG	7.5
Contact to Mounting Surface	Contact + 20 AWG	7.5

Contacts

Contact Size		Size of Conductors standard cables	Outer Dia. of Cables (mm)		Current (A) per Contact
Contact	Barrel		Min.	Max.	
22	22	22	0.86	1.45	5
		24	0.86	1.45	3
		26	0.86	1.45	2
20	20	20	1.02	1.80	7.5
		22	1.02	1.80	5
		24	1.02	1.80	3
18	16	16	1.73	2.62	13
		18	1.73	2.62	13
		20	1.73	2.62	7.5
12	12	12	2.46	3.43	23
		14	2.46	3.43	17
8	8	8	4.80	5.75	46
5 ¹	8	8	4.80	5.75	80
		10	4.80	5.75	33

¹ Size 5 contacts are not part of MIL-C-39029 type A.

EMI Shielding Effectiveness

Frequency (MHz)	Leakage Attenuation (dB)
100	65
200	63
300	63
400	62
500	60
600	60

Mechanical Characteristics

Mating/Unmating Durability — 100 cycles

Mating Torque for GPRB2 Jackscrew — 1.2 Nm [11 in. lbs.]

Random Vibration —

GPRA & legacy GPRB1 — 20g (MIL-STD-1344/Method 2005.1, test condition 4)

GPRB1 (new aluminum & composite versions) & GPRB2 — random vibration, 26.4g (rms) (MIL-STD-1344/Method 2005.1, test condition 6, letter G)

Shock — 50g (MIL-STD-1344/Method 2004.1, test condition A)

Environmental Characteristics

Temperature Range — -65°C to +175°C [-85°F to +347°F]

Temperature Life — 1000 h @ 155°C [311°F]

Salt Spray — 96 hours (nickel plating) (MIL-STD-1344/Method 1001.1, test condition A)

Humidity — 10 days

Altitude Immersion — 3 cycles at 15,240 m [50,000 ft.] (MIL-STD-1344/Method 1004.1)

Fluid Immersion — (MIL-STD-1344/Method 1016)

Dielectric Withstanding Voltage (MIL-STD-1344/Method 3001.1.1 with Leakage Current < 1 mΩ)

Level	Voltage (VRMS)
Sea level	1500
15,240 m [50,000 feet]	800

Insulation Resistance (MIL-STD-1344/Method 3003.1)

Ambient Temperature	> 5,000 MΩ
175°C [347°F]	> 200 MΩ

Other Characteristics

Shell to Shell Conductivity — < 2.5 mΩ

Operating Voltage — 400 Vrms or 500 Vdc at sea level

Voltage Stability (Ground Block) — Maximum variation 4mV (MIL-T-81714)

Magnetic Permeability — < 2

Comparative Tracking Index — 250 V

Contact Retention — (MIL-STD-1344/Method 2007.1 on terminated connectors)

Contact Size	Retention Force	Max. Displacement
Ground Block	88 N [20 lbs.]	0.3 mm [.012 in.]
22	53.4 N [12 lbs.]	0.38 mm [.015 in.]
20	89 N [20 lbs.]	0.38 mm [.015 in.]
16	111.2 N [25 lbs.]	0.38 mm [.015 in.]
12	133.45 N [30 lbs.]	0.38 mm [.015 in.]

Insert Retention — 500 N [112 lbs.] (MIL-STD-1344/Method 2010.1)

GPR1 Shell Descriptive Part Number Format

Descriptive Part Numbering System

Use this guide to construct descriptive part numbers for GPR1 shells. Refer to table below for the corresponding TE Connectivity Part Number.

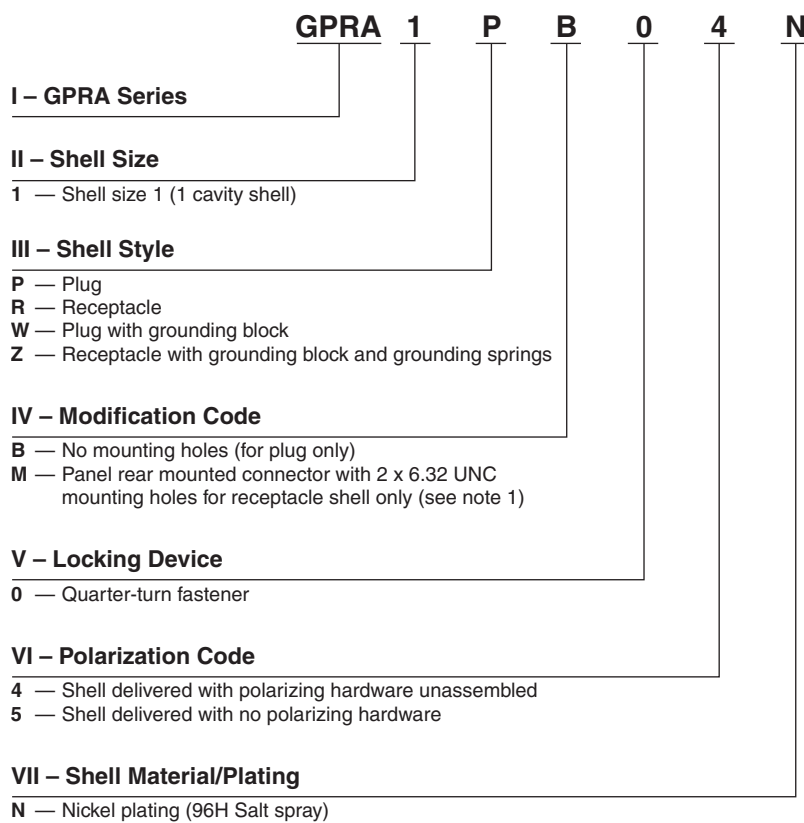

Note 1: Self-locking mounting holes are designed for rear panel mounting.

Size	Style	Modification	Locking Device	Polarization Hardware	Plating	Descriptive Part Number	TE Part Number
1	Plug	No mounting holes	1/4-Turn Fastener	Kit: Shell & Hardware Unassembled	Nickel	GPR1PB04N	1738228-1
				No Hardware		GPR1PB05N	1738229-1
	Plug, with Grounding Block	Rear Panel Mount, with two 6-32 UNC holes		Kit: Shell & Hardware Unassembled		GPR1WB04N	1738230-1
				No Hardware		GPR1WB05N	1738231-1
	Receptacle	Rear Panel Mount, with two 6-32 UNC holes		Kit: Shell & Hardware Unassembled		GPR1RM04N	1738232-1
				No Hardware		GPR1RM05N	1738233-1
Receptacle, with Grounding Block & Grounding Springs		Kit: Shell & Hardware Unassembled	GPR1ZM04N	1738234-1			
		No Hardware	GPR1ZM05N	1738235-1			

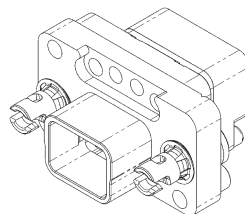

GPR1WB05N

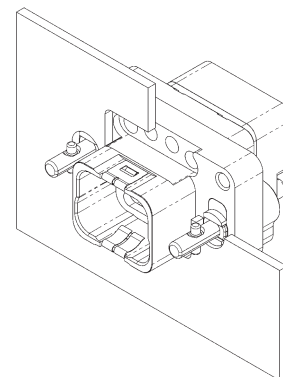

**GPR1ZM05N
Panel Rear Mounted Connector**

GPRA1 Shell Dimensions

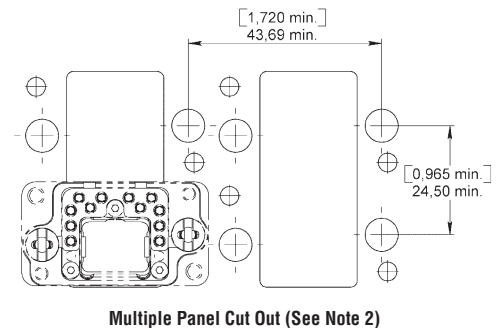
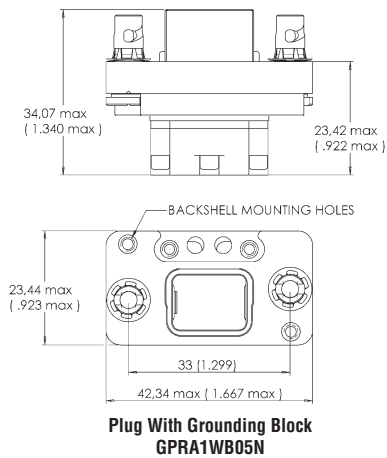
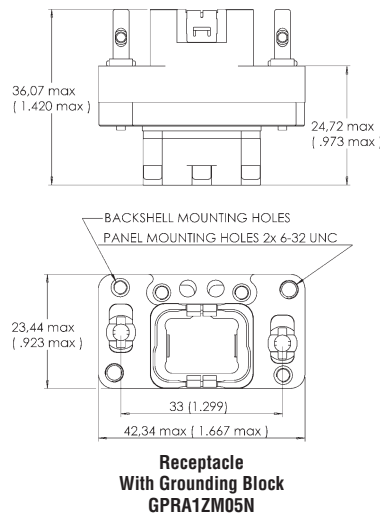
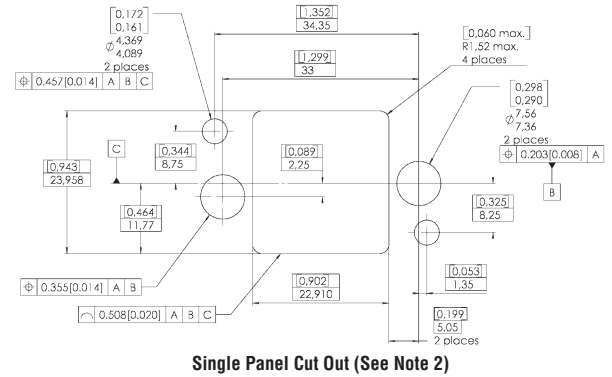
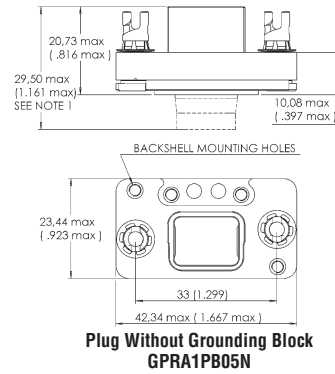
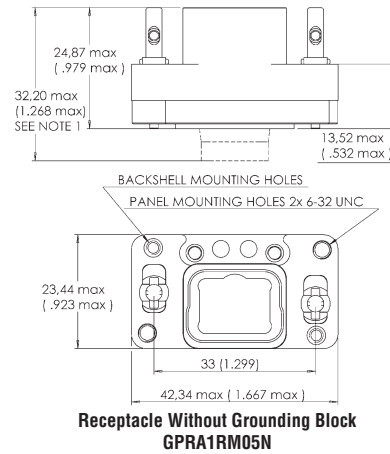

Note 1: Maximum dimension for inserts with grommets (Part Number GPRAE and GPRAH)
Note 2: Rear mounting side view with key post oriented to the upper side (receptacle only)

GPRB1 Shell Descriptive Part Number Format

Descriptive Part Numbering System

Use this guide to construct descriptive part numbers for GPRB1 shells. Refer to table below for the corresponding TE Part Number.

Note: Legacy designs are not backward compatible with the improved B1 shell designs.

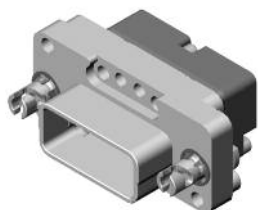

GPRB1WB05N

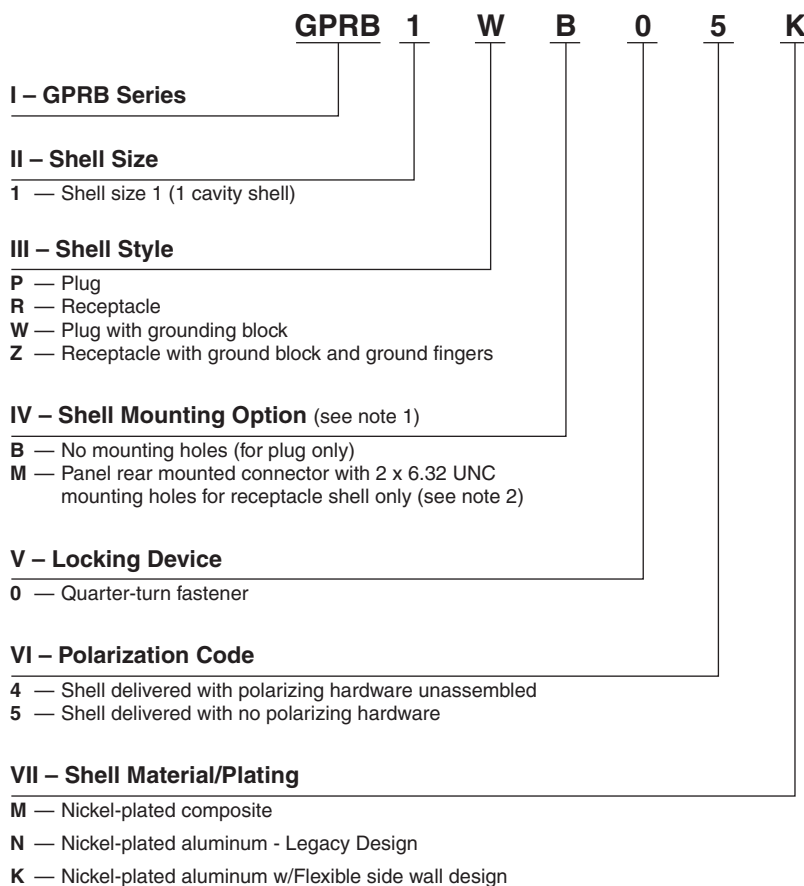

Note 1: Recommended locking torque: 1.6 Nm (14.161 in-lbs) for metallic shell and 1 Nm (8.85 in-lbs) min. 1.1 Nm (9.73 in-lbs) max. for composite shell.

Note 2: Self-locking mounting holes are designed for rear panel mounting.

Legacy Design - Aluminum

Size	Style	Modification	Locking Device	Polarization Hardware	Shell Material	Descriptive Part Number	TE Part Number
1	Plug	No mounting holes	1/4-Turn Fastener	Kit: Shell & Hardware Unassembled	Aluminum	GPRB1PB04N	1738236-1
				No Hardware		GPRB1PB05N	1738237-1
	Plug, with Grounding Block	Rear Panel Mount, with two 6-32 UNC holes		Kit: Shell & Hardware Unassembled		GPRB1WB04N	1738238-1
				No Hardware		GPRB1WB05N	1738239-1
	Receptacle	Rear Panel Mount, with two 6-32 UNC holes		Kit: Shell & Hardware Unassembled		GPRB1RM04N	1738240-1
				No Hardware		GPRB1RM05N	1738241-1
Receptacle, with Grounding Block & Grounding Springs	Rear Panel Mount, with two 6-32 UNC holes	Kit: Shell & Hardware Unassembled	GPRB1ZM04N	1738242-1			
		No Hardware	GPRB1ZM05N	1738243-1			

Flexible Sidewall Design - Composite & Aluminum

Size	Style	Modification	Locking Device	Polarization Hardware	Shell Material	Descriptive Part Number	TE Part Number
1	Plug	No mounting holes	1/4-Turn Fastener	Kit: Shell & Hardware Unassembled	Composite	GPRB1PB04M	1811680-1
					Aluminum	—	—
	Plug, with Grounding Block	Rear Panel Mount, with two 6-32 UNC holes			Composite	GPRB1WB04M	1954285-1
					Aluminum	GPRB1WB04K	1877943-1
	Receptacle	Rear Panel Mount, with two 6-32 UNC holes			Composite	GPRB1RM04M	2000142-1
					Aluminum	—	—
Receptacle, with Grounding Block & Grounding Springs	Rear Panel Mount, with two 6-32 UNC holes	Composite	GPRB1ZM04M	1954284-1			
		Aluminum	GPRB1ZM04K	1877945-1			

GPRB1 Shell Dimensions - Flexible Sidewall Design

Product Facts

- A high density solution compared to circular connectors
- Shell-to-shell grounding with integral grounding springs - does not require separate spring clip components
- Improved vibration performance
- New 1/4-turn fastener profile with reduced risk of breakage
- L-shaped keys – easier to install and remove, each face is identified, shape decrease risk of incorrect assembly

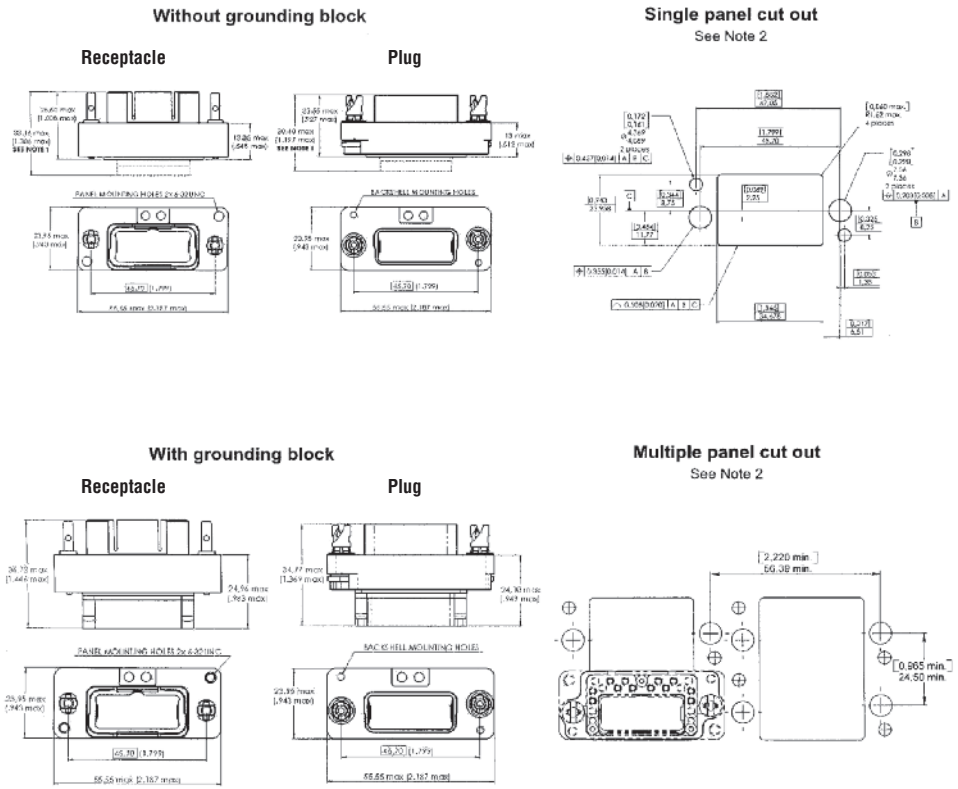

Note 1: Maximum dimension for inserts with grommets (Part Number GPRBE and GPRBH) For inserts without grommets, max. dimensions will be for the receptacle 25.55 mm - 1.006 in. and for the plug 23.52 mm - .926 in.

For inserts with optical contacts F12 and 12F6, the max. dimensions will be for the receptacle 38.70 mm - 1.524 in. and for the plug 36.00 mm - 1.148 in.

Note 2: Rear mounting side view with key post oriented to the upper side (receptacle only)

GPRB2 (Horizontal) Shell Descriptive Part Number Format

Descriptive Part Numbering System

Use this guide to construct descriptive part numbers for GPRB2 shells. Refer to page 8-12 for the corresponding TE Part Number.

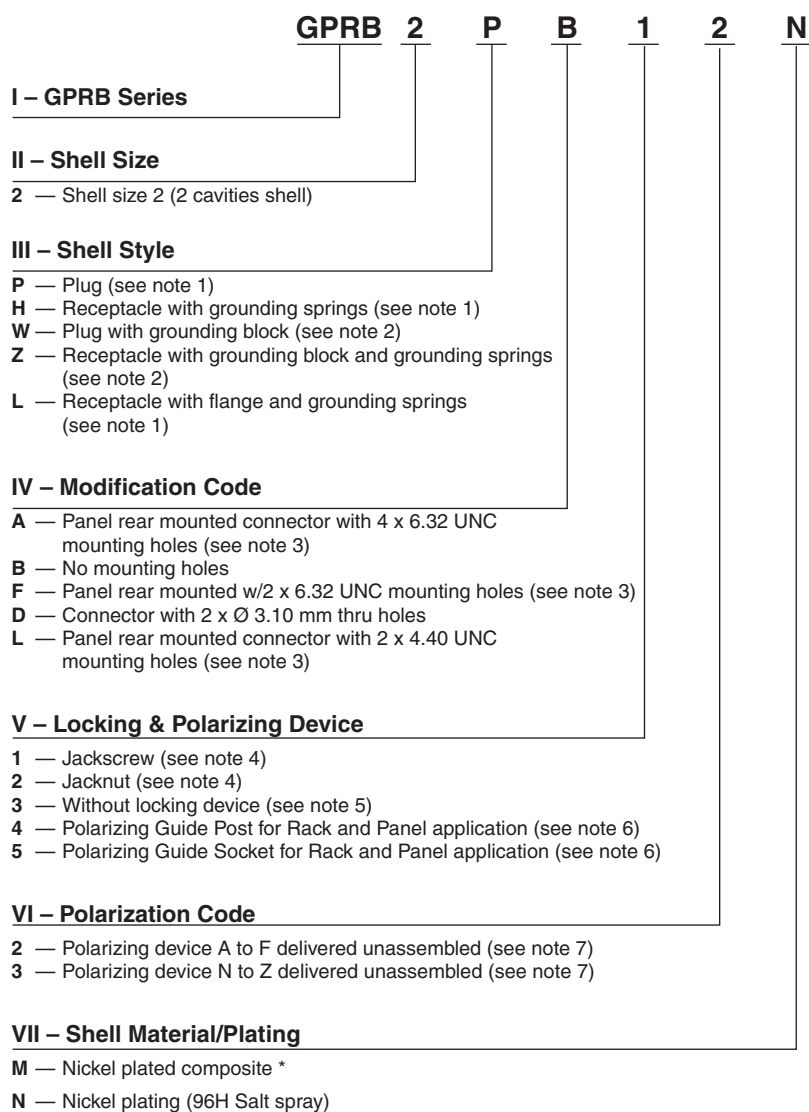

- Notes: 1. The standard modification codes for these shells are B, D or L.
 2. With modification codes A or B only.
 3. Self-locking mounting holes are designed for rear panel mounting.
 4. Jackscrew/Jacknut can be mounted on either plug or receptacle shell. However, the standard options are:
 —Jackscrew for plug shells
 —Jacknut for receptacle shells
 5. Option 3 in paragraph V cancels the polarization code paragraph IV, i.e. the shell is delivered with no polarizing device.
 6. Pin/Socket polarization guides can be mounted on either plug or receptacle shells. However, the standard options are:
 —Pin polarization guide for plug shells
 —Socket polarization guide for receptacle shells
 7. Polarizing device is delivered unassembled, it must be locked with resin by the user (LOCTITE™ 272 must be used).
 —if no polarizing device is required, omit this step and go to VII.

*Contact TE Connectivity

GPRB2 (Horizontal) Shell Descriptive Part Number Format (Continued)

Size	Style	Modification	Locking & Polarization Device	Polarization Hardware	Plating	Descriptive Part Number	TE Part Number
2	Plug	No mounting holes	N/A	N/A	Nickel	GPRB2PB3N	1738244-1
			Jackscrew	Kit: Shell & A-F Hardware Unassembled		GPRB2PB12N	1738245-1
				Kit: Shell & N-Z Hardware Unassembled		GPRB2PB13N	1738246-1
			Polarizing Guide Post	Kit: Shell & A-F Hardware Unassembled		GPRB2PB42N	1738247-1
			Kit: Shell & N-Z Hardware Unassembled	GPRB2PB43N		1738248-1	
		Connector with two thru-holes [3.10 mm Dia.]	N/A	N/A		GPRB2PD3N	1738249-1
			Jackscrew	Kit: Shell & A-F Hardware Unassembled		GPRB2PD12N	1738250-1
				Kit: Shell & N-Z Hardware Unassembled		GPRB2PD13N	1738251-1
			Polarizing Guide Post	Kit: Shell & A-F Hardware Unassembled		GPRB2PD42N	1738252-1
			Kit: Shell & N-Z Hardware Unassembled	GPRB2PD43N		1738253-1	
		Rear Panel Mount, with two 4-40 UNC holes	N/A	N/A		GPRB2PL3N	1738254-1
			Jackscrew	Kit: Shell & A-F Hardware Unassembled		GPRB2PL12N	1738255-1
			Kit: Shell & N-Z Hardware Unassembled	GPRB2PL13N	1738256-1		
	Polarizing Guide Post		Kit: Shell & A-F Hardware Unassembled	GPRB2PL42N	1738257-1		
		Kit: Shell & N-Z Hardware Unassembled	GPRB2PL43N	1738258-1			
	Plug, with Grounding Block	No mounting holes	N/A	N/A	GPRB2WB3N	1738259-1	
			Jackscrew	Kit: Shell & A-F Hardware Unassembled	GPRB2WB12N	1738260-1	
				Kit: Shell & N-Z Hardware Unassembled	GPRB2WB13N	1738261-1	
			Polarizing Guide Post	Kit: Shell & A-F Hardware Unassembled	GPRB2WB42N	1738262-1	
			Kit: Shell & N-Z Hardware Unassembled	GPRB2WB43N	1738263-1		
		Rear Panel Mount, with four 6-32 UNC holes	N/A	N/A	GPRB2WA3N	1738264-1	
			Jackscrew	Kit: Shell & A-F Hardware Unassembled	GPRB2WA12N	1738265-1	
				Kit: Shell & N-Z Hardware Unassembled	GPRB2WA13N	1738266-1	
			Polarizing Guide Post	Kit: Shell & A-F Hardware Unassembled	GPRB2WA42N	1738267-1	
		Kit: Shell & N-Z Hardware Unassembled	GPRB2WA43N	1738268-1			
Receptacle, with Grounding Springs		No mounting holes	N/A	N/A	GPRB2HB3N	1738269-1	
			Jacknut	Kit: Shell & A-F Hardware Unassembled	GPRB2HB22N	1738270-1	
			Kit: Shell & N-Z Hardware Unassembled	GPRB2HB23N	1738271-1		
	Polarizing Guide Socket		Kit: Shell & A-F Hardware Unassembled	GPRB2HB52N	1738272-1		
		Kit: Shell & N-Z Hardware Unassembled	GPRB2HB53N	1738273-1			
	Connector with two thru-holes [3.10 mm Dia.]	N/A	N/A	GPRB2HD3N	1738274-1		
		Jacknut	Kit: Shell & A-F Hardware Unassembled	GPRB2HD22N	1738275-1		
			Kit: Shell & N-Z Hardware Unassembled	GPRB2HD23N	1738276-1		
		Polarizing Guide Socket	Kit: Shell & A-F Hardware Unassembled	GPRB2HD52N	1738277-1		
		Kit: Shell & N-Z Hardware Unassembled	GPRB2HD53N	1738278-1			
	Rear Panel Mount, with two 4-40 UNC holes	N/A	N/A	GPRB2HL3N	1738279-1		
		Jacknut	Kit: Shell & A-F Hardware Unassembled	GPRB2HL22N	1738280-1		
		Kit: Shell & N-Z Hardware Unassembled	GPRB2HL23N	1738281-1			
Polarizing Guide Socket		Kit: Shell & A-F Hardware Unassembled	GPRB2HL52N	1738282-1			
	Kit: Shell & N-Z Hardware Unassembled	GPRB2HL53N	1738283-1				
Rear Panel Mount, with two 6-32 UNC holes	N/A	N/A	GPRB2HF3N	1738279-2			
	Jacknut	Kit: Shell & A-F Hardware Unassembled	GPRB2HF22N	1738280-2			
		Kit: Shell & N-Z Hardware Unassembled	GPRB2HF23N	1738281-2			
	Polarizing Guide Socket	Kit: Shell & A-F Hardware Unassembled	GPRB2HF52N	1738282-2			
	Kit: Shell & N-Z Hardware Unassembled	GPRB2HF53N	1738283-2				
Receptacle, with Flange & Grounding Springs	No mounting holes	N/A	N/A	GPRB2LB3N	1738284-1		
		Jacknut	Kit: Shell & A-F Hardware Unassembled	GPRB2LB22N	1738285-1		
			Kit: Shell & N-Z Hardware Unassembled	GPRB2LB23N	1738286-1		
		Polarizing Guide Socket	Kit: Shell & A-F Hardware Unassembled	GPRB2LB52N	1738287-1		
		Kit: Shell & N-Z Hardware Unassembled	GPRB2LB53N	1738288-1			
	Connector with two thru-holes [3.10 mm Dia.]	N/A	N/A	GPRB2LD3N	1738289-1		
		Jacknut	Kit: Shell & A-F Hardware Unassembled	GPRB2LD22N	1738290-1		
			Kit: Shell & N-Z Hardware Unassembled	GPRB2LD23N	1738291-1		
		Polarizing Guide Socket	Kit: Shell & A-F Hardware Unassembled	GPRB2LD52N	1738292-1		
		Kit: Shell & N-Z Hardware Unassembled	GPRB2LD53N	1738293-1			
	Mount, with two 4-40 UNC holes	N/A	N/A	GPRB2LL3N	1738294-1		
		Jacknut	Kit: Shell & A-F Hardware Unassembled	GPRB2LL22N	1738295-1		
		Kit: Shell & N-Z Hardware Unassembled	GPRB2LL23N	1738296-1			
Polarizing Guide Socket		Kit: Shell & A-F Hardware Unassembled	GPRB2LL52N	1738297-1			
	Kit: Shell & N-Z Hardware Unassembled	GPRB2LL53N	1738298-1				
Rear Panel Mount, with two 6-32 UNC holes	N/A	N/A	GPRB2LF3N	1738294-2			
	Jacknut	Kit: Shell & A-F Hardware Unassembled	GPRB2LF22N	1738295-2			
		Kit: Shell & N-Z Hardware Unassembled	GPRB2LF23N	1738296-2			
	Polarizing Guide Socket	Kit: Shell & A-F Hardware Unassembled	GPRB2LF52N	1738297-2			
	Kit: Shell & N-Z Hardware Unassembled	GPRB2LF53N	1738298-2				

GPRB2 (Horizontal) Shell Descriptive Part Number Format (Continued)

Size	Style	Modification	Locking & Polarization Device	Polarization Hardware	Plating	Descriptive Part Number	TE Part Number
2	Receptacle, with Grounding Block & Grounding Springs	No mounting holes	N/A	N/A	Nickel	GPRB2ZB3N	1738299-1
			Jacknut	Kit: Shell & A-F Hardware Unassembled		GPRB2ZB22N	1738300-1
				Kit: Shell & N-Z Hardware Unassembled		GPRB2ZB23N	1738301-1
			Polarizing Guide Socket	Kit: Shell & A-F Hardware Unassembled		GPRB2ZB52N	1738302-1
			Kit: Shell & N-Z Hardware Unassembled	GPRB2ZB53N		1738303-1	
		Rear Panel Mount, with four 6-32 UNC holes	N/A	N/A		GPRB2ZA3N	1738304-1
			Jacknut	Kit: Shell & A-F Hardware Unassembled		GPRB2ZA22N	1738305-1
				Kit: Shell & N-Z Hardware Unassembled		GPRB2ZA23N	1738306-1
			Polarizing Guide Socket	Kit: Shell & A-F Hardware Unassembled		GPRB2ZA52N	1738307-1
				Kit: Shell & N-Z Hardware Unassembled		GPRB2ZA53N	1738308-1

GPRB2 (Horizontal) Shell Dimensions

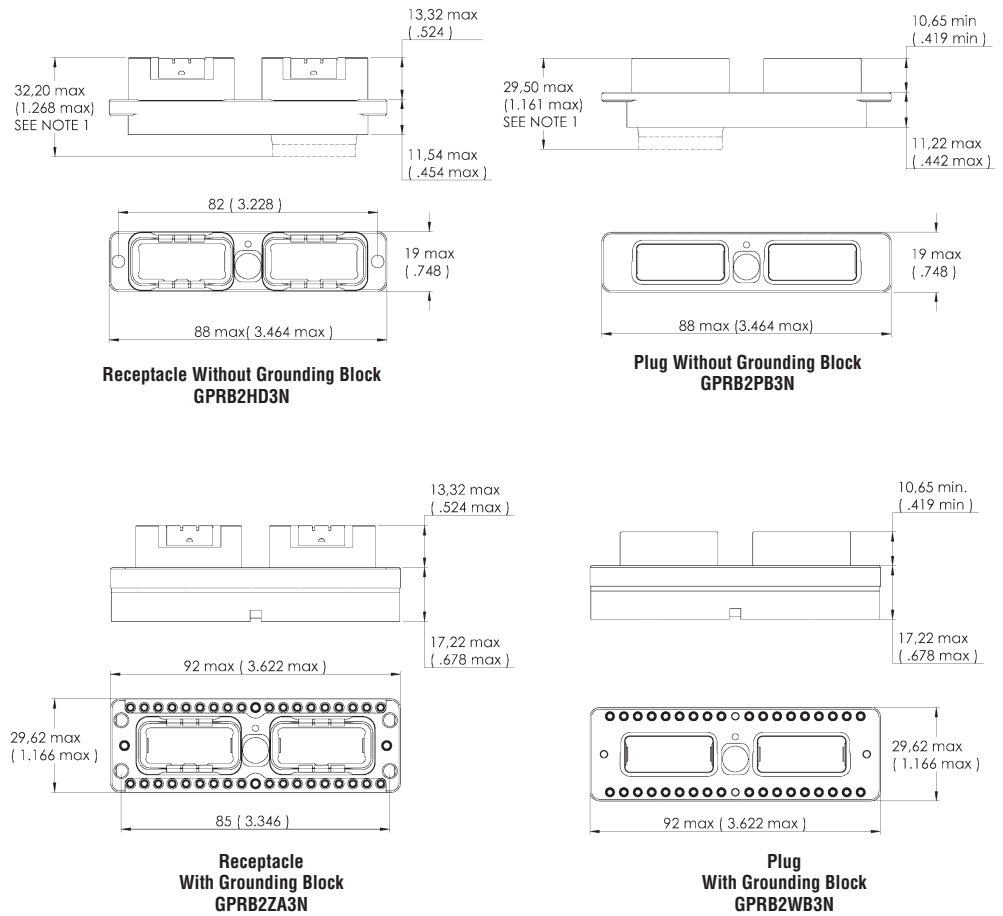

Grounding Block

A solution for high-intensity radiated electromagnetic frequencies. The patented design provides a direct grounding to the shell.

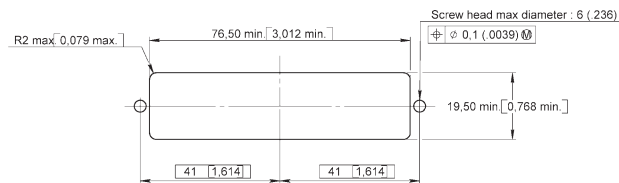
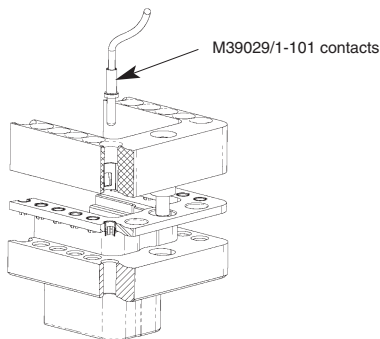

**Panel Cut Out
Modification Code D and L**

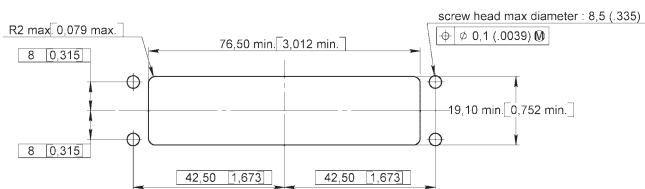

**Panel Cut Out
Modification Code A**

Note 1: Maximum dimension for inserts with grommets (Part Number GPRBE and GPRBH)

GPRB2 Vertical (Square) Shell and Strain Relief Dimensions

Shell Kits with Two Cavities for Key-A Inserts

¹Kit: Shell & A-F hardware unassembled
²Assembly: Hardware assembled in polarization position E

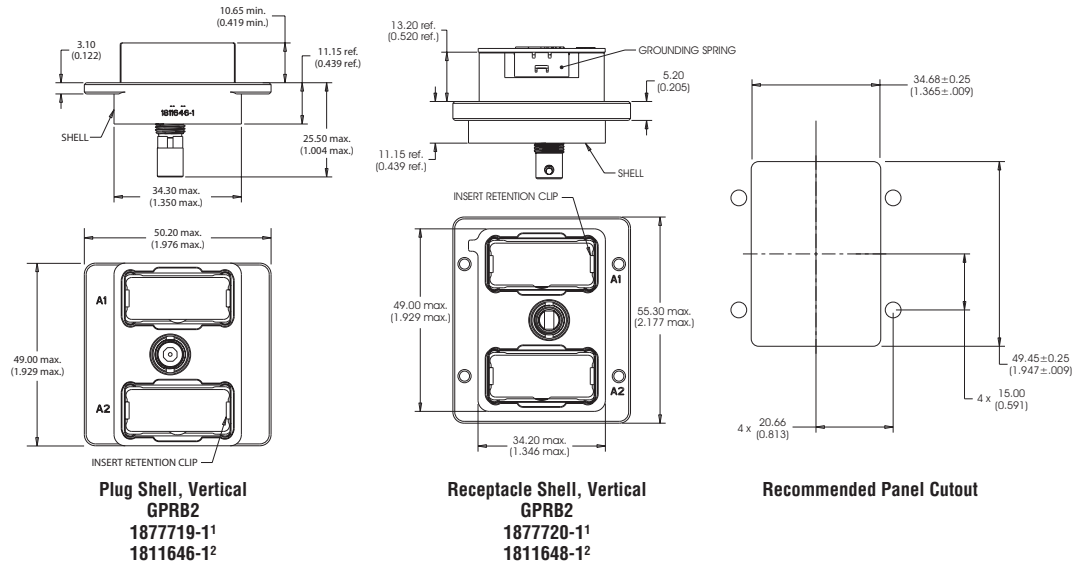

Shell Kits with Two Cavities for Key-A and Key-B Inserts

¹Kit: Shell & A-F hardware unassembled

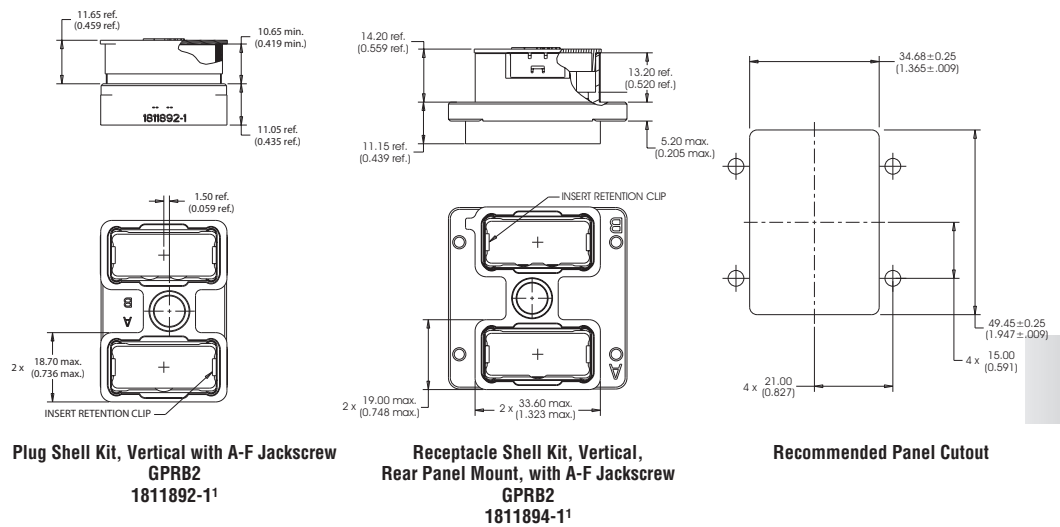

Strain Relief Kit, Vertical GPRB2

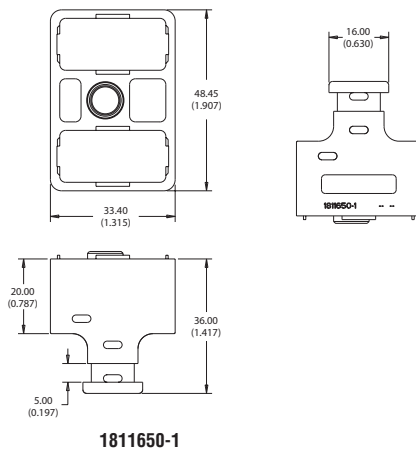

Insert Descriptive Part Number Format

Descriptive Part Numbering System

Use this guide to construct descriptive part numbers for GPR & B inserts. Refer to pages 8-16 to 8-19 for the corresponding TE Part Number.

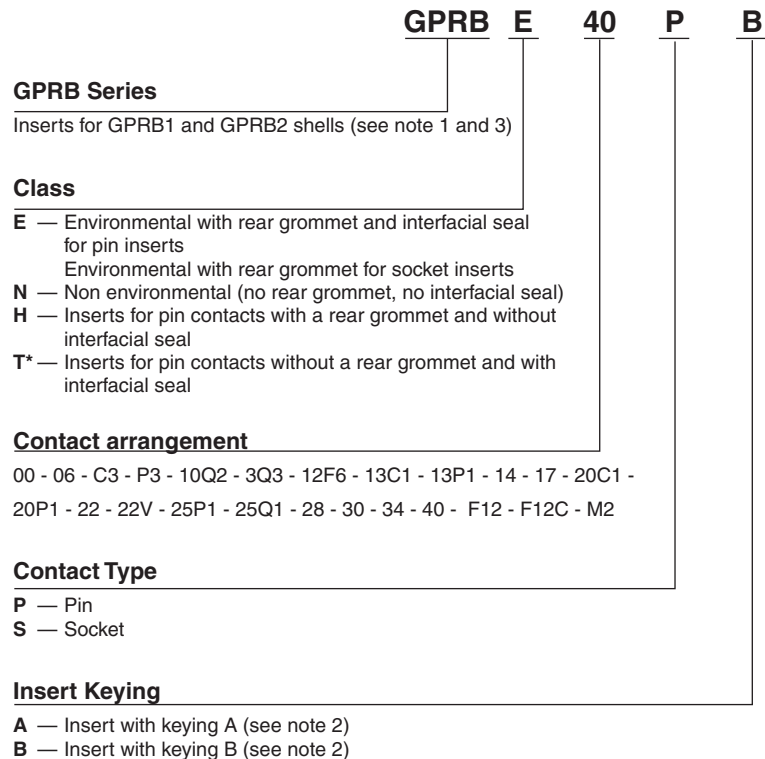
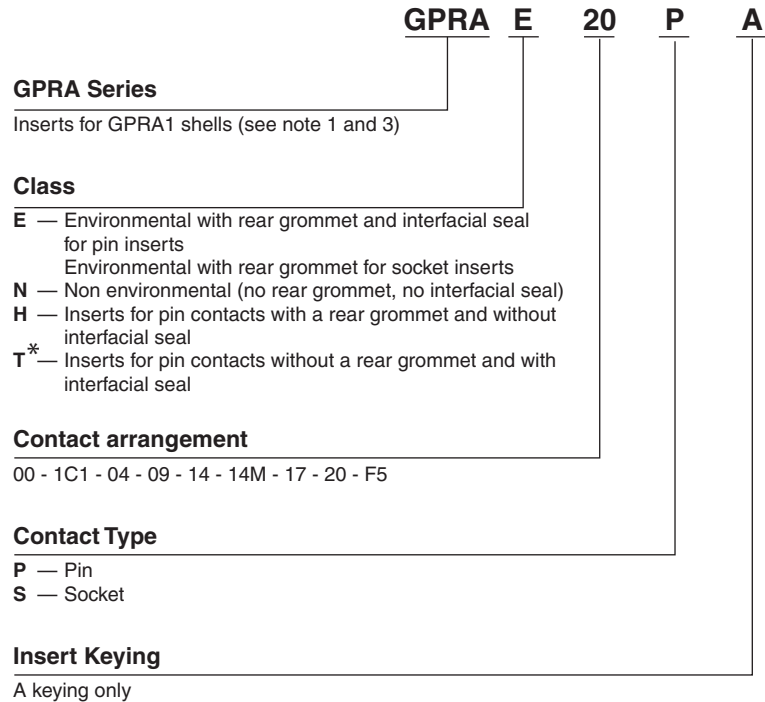

- Notes: 1. Inserts are designed for rear release contacts.
 2. For GPR B2 shells, use one insert keyed A and one insert keyed B.
 For GPR B1 shells, use one insert keyed A only.
 3. Pin and socket inserts can be installed in either plug or receptacle shell.

*Contact TE

Insert Descriptive Part Number Format (Continued)

GPRA Insert Part Numbers

Series	Contact Arrangement	Contact Type	Classification	Keying	Descriptive Part Number	TE Part Number
A	00	N/A	Dummy Insert	N/A	GPRAN00	1738049-1
			Environmental, with Rear Grommet & Interfacial Seal		GPRAE1C1PA	1738050-1
	1C1	Pin	Insert with Rear Grommet, without Interfacial Seal	GPRAH1C1PA	1738051-1	
			Non-environmental (no Grommet or Seal)	GPRAN1C1PA	1738052-1	
		Socket	Environmental, with Rear Grommet	GPRAE1C1SA	1738053-1	
			Non-environmental (no Grommet or Seal)	GPRAN1C1SA	1738054-1	
	04	Pin	Environmental, with Rear Grommet & Interfacial Seal	GPRAE04PA	1738055-1	
			Insert with Rear Grommet, without Interfacial Seal	GPRAH04PA	1738056-1	
		Socket	Non-environmental (no Grommet or Seal)	GPRAN04PA	1738057-1	
			Environmental, with Rear Grommet	GPRAE04SA	1738058-1	
	09	Pin	Non-environmental (no Grommet or Seal)	GPRAN04SA	1738059-1	
			Environmental, with Rear Grommet & Interfacial Seal	GPRAE09PA	1738060-1	
		Socket	Insert with Rear Grommet, without Interfacial Seal	GPRAH09PA	1738061-1	
			Non-environmental (no Grommet or Seal)	GPRAN09PA	1738062-1	
	14	Pin	Environmental, with Rear Grommet	GPRAE09SA	1738063-1	
			Non-environmental (no Grommet or Seal)	GPRAN09SA	1738064-1	
		Socket	Environmental, with Rear Grommet & Interfacial Seal	GPRAE14PA	1738065-1	
			Insert with Rear Grommet, without Interfacial Seal	GPRAH14PA	1738066-1	
	14M	Pin	Non-environmental (no Grommet or Seal)	GPRAN14PA	1738067-1	
			Environmental, with Rear Grommet	GPRAE14SA	1738068-1	
		Socket	Non-environmental (no Grommet or Seal)	GPRAN14SA	1738069-1	
			Environmental, with Rear Grommet & Interfacial Seal	GPRAE14MPA	1738070-1	
	17	Pin	Insert with Rear Grommet, without Interfacial Seal	GPRAH14MPA	1738071-1	
			Non-environmental (no Grommet or Seal)	GPRAN14MPA	1738072-1	
		Socket	Environmental, with Rear Grommet	GPRAE14MSA	1738073-1	
			Non-environmental (no Grommet or Seal)	GPRAN14MSA	1738074-1	
	20	Pin	Environmental, with Rear Grommet & Interfacial Seal	GPRAE17PA	1738075-1	
			Insert with Rear Grommet, without Interfacial Seal	GPRAH17PA	1738076-1	
		Socket	Non-environmental (no Grommet or Seal)	GPRAN17PA	1738077-1	
			Environmental, with Rear Grommet	GPRAE17SA	1738078-1	
F5	Pin	Non-environmental (no Grommet or Seal)	GPRAN17SA	1738079-1		
		Environmental, with Rear Grommet & Interfacial Seal	GPRAE20PA	1738080-1		
	Socket	Insert with Rear Grommet, without Interfacial Seal	GPRAH20PA	1738081-1		
		Non-environmental (no Grommet or Seal)	GPRAN20PA	1738082-1		
ARINC 801 Termini	Pin	Environmental, with Rear Grommet	GPRAE20SA	1738083-1		
		Non-environmental (no Grommet or Seal)	GPRAN20SA	1738084-1		
ARINC 801 Termini	Socket	Environmental, without Sleeve Holder	GPRAEF5PA	1954043-1		
		Environmental, with Sleeve Holder	GPRAEF5SA	1954044-1		

Insert Descriptive Part Number Format (Continued)

GPRB Insert Part Numbers

Series	Contact Arrangement	Contact Type	Classification	Keying	Descriptive Part Number	TE Part Number	
B	00	N/A	Dummy Insert	N/A	GPRBN00	1738085-1	
			Environmental, with Rear Grommet & Interfacial Seal	A	GPRBEC3PA	1738086-1	
	C3	Pin	Insert with Rear Grommet, without Interfacial Seal	B	GPRBEC3PB	1738091-1	
				A	GPRBHC3PA	1738087-1	
		Socket	Non-environmental (no Grommet or Seal)	B	GPRBHC3PB	1738092-1	
				A	GPRBNC3PA	1738088-1	
	P3	Pin	Environmental, with Rear Grommet & Interfacial Seal	B	GPRBNC3PB	1738093-1	
				A	GPRBEC3SA	1738089-1	
			Non-environmental (no Grommet or Seal)	B	GPRBEC3SB	1738094-1	
				A	GPRBNC3SA	1738090-1	
		Socket	Environmental, with Rear Grommet	B	GPRBNC3SB	1738095-1	
				A	GPRBEP3PA	1954321-1	
			Non-environmental (no Grommet or Seal)	B	GPRBEP3PB	1954322-1	
				A	GPRBHP3PA	1954724-1	
		06	Pin	Environmental, with Rear Grommet & Interfacial Seal	B	GPRBHP3PB	1954739-1
					A	GPRBNP3PA	1954325-1
				Non-environmental (no Grommet or Seal)	B	GPRBNP3PB	1954326-1
					A	GPRBEP3SA	1954327-1
	Socket		Environmental, with Rear Grommet	B	GPRBEP3SB	1954328-1	
				A	GPRBNP3SA	1954329-1	
			Non-environmental (no Grommet or Seal)	B	GPRBNP3SB	1954330-1	
				A	GPRBE06PA	1738096-1	
	13C1	Pin	Environmental, with Rear Grommet & Interfacial Seal	B	GPRBE06PB	1738101-1	
				A	GPRBH06PA	1738096-2	
			Non-environmental (no Grommet or Seal)	B	GPRBH06PB	1738101-3	
				A	GPRBN06PA	1738096-3	
			Socket	Environmental, with Rear Grommet	B	GPRBN06PB	1738101-4
					A	GPRBE06SA	1738099-1
				Non-environmental (no Grommet or Seal)	B	GPRBE06SB	1738104-1
					A	GPRBN06SA	1738099-2
		13P1	Pin	Environmental, with Rear Grommet & Interfacial Seal	B	GPRBN06SB	1738104-2
					A	GPRBE13C1PA	1738106-1
				Non-environmental (no Grommet or Seal)	B	GPRBE13C1PB	1738111-1
					A	GPRBH13C1PA	1738107-1
			Socket	Environmental, with Rear Grommet	B	GPRBH13C1PB	1738112-1
					A	GPRBN13C1PA	1738108-1
				Non-environmental (no Grommet or Seal)	B	GPRBN13C1PB	1738113-1
					A	GPRBE13C1SA	1738109-1
	13P1	Pin	Environmental, with Rear Grommet & Interfacial Seal	B	GPRBE13C1SB	1738114-1	
				A	GPRBN13C1SA	1738110-1	
			Non-environmental (no Grommet or Seal)	B	GPRBN13C1SB	1738115-1	
				A	GPRBE13P1PA	1954331-1	
		Socket	Environmental, with Rear Grommet & Interfacial Seal	B	GPRBE13P1PB	1954332-1	
				A	GPRBH13P1PA	1954333-1	
			Non-environmental (no Grommet or Seal)	B	GPRBH13P1PB	1954334-1	
				A	GPRBN13P1PA	1954335-1	
	13P1	Pin	Insert with Rear Grommet, without Interfacial Seal	B	GPRBN13P1PB	1954336-1	
				A	GPRBE13P1SA	1954337-1	
Socket		Environmental, with Rear Grommet	B	GPRBE13P1SB	1954338-1		
			A	GPRBN13P1SA	1954339-1		
13P1	Socket	Non-environmental (no Grommet or Seal)	B	GPRBN13P1SB	1954340-1		
			A	GPRBN13P1SB	1954340-1		

Insert Descriptive Part Number Format (Continued)

GPRB Insert Part Numbers (Continued)

Series	Contact Arrangement	Contact Type	Classification	Keying	Descriptive Part Number	TE Part Number		
B	14	Pin	Environmental, with Rear Grommet & Interfacial Seal	A	GPRBE14PA	1738116-1		
				B	GPRBE14PB	1738121-1		
			Insert with Rear Grommet, without Interfacial Seal	A	GPRBH14PA	1738117-1		
				B	GPRBH14PB	1738122-1		
			Non-environmental (no Grommet or Seal)	A	GPRBN14PA	1738118-1		
				B	GPRBN14PB	1738123-1		
		Socket	Environmental, with Rear Grommet	A	GPRBE14SA	1738119-1		
				B	GPRBE14SB	1738124-1		
			Non-environmental (no Grommet or Seal)	A	GPRBN14SA	1738120-1		
				B	GPRBN14SB	1738125-1		
			17	Pin	Environmental, with Rear Grommet & Interfacial Seal	A	GPRBE17PA	1738126-1
						B	GPRBE17PB	1738131-1
	Insert with Rear Grommet, without Interfacial Seal	A			GPRBH17PA	1738127-1		
		B			GPRBH17PB	1738132-1		
	Non-environmental (no Grommet or Seal)	A			GPRBN17PA	1738128-1		
		B			GPRBN17PB	1738133-1		
	Socket	Environmental, with Rear Grommet		A	GPRBE17SA	1738129-1		
				B	GPRBE17SB	1738134-1		
		Non-environmental (no Grommet or Seal)		A	GPRBN17SA	1738130-1		
				B	GPRBN17SB	1738135-1		
		20C1		Pin	Environmental, with Rear Grommet & Interfacial Seal	A	GPRBE20C1PA	1738136-1
						B	GPRBE20C1PB	1738141-1
	Insert with Rear Grommet, without Interfacial Seal		A		GPRBH20C1PA	1738137-1		
			B		GPRBH20C1PB	1738142-1		
	Non-environmental (no Grommet or Seal)		A		GPRBN20C1PA	1738138-1		
			B		GPRBN20C1PB	1738143-1		
	Socket		Environmental, with Rear Grommet	A	GPRBE20C1SA	1738139-1		
				B	GPRBE20C1SB	1738144-1		
			Non-environmental (no Grommet or Seal)	A	GPRBN20C1SA	1738140-1		
				B	GPRBN20C1SB	1738145-1		
			20P1	Pin	Environmental, with Rear Grommet & Interfacial Seal	A	GPRBE20P1PA	1954341-1
						B	GPRBE20P1PB	1954342-1
	Insert with Rear Grommet, without Interfacial Seal	A			GPRBH20P1PA	1954723-1		
		B			GPRBH20P1PB	1954344-1		
	Non-environmental (no Grommet or Seal)	A			GPRBN20P1PA	1954345-1		
		B			GPRBN20P1PB	1954346-1		
Socket	Environmental, with Rear Grommet	A		GPRBE20P1SA	1954347-1			
		B		GPRBE20P1SB	1954348-1			
	Non-environmental (no Grommet or Seal)	A		GPRBN20P1SA	1954349-1			
		B		GPRBN20P1SB	1954350-1			
	22	Pin		Environmental, with Rear Grommet & Interfacial Seal	A	GPRBE22PA	1738146-1	
					B	GPRBE22PB	1738151-1	
Insert with Rear Grommet, without Interfacial Seal			A	GPRBH22PA	1738146-2			
			B	GPRBH22PB	1738151-2			
Non-environmental (no Grommet or Seal)			A	GPRBN22PA	1738146-3			
			B	GPRBN22PB	1738151-3			
Socket		Environmental, with Rear Grommet	A	GPRBE22SA	1738149-1			
			B	GPRBE22SB	1738154-1			
		Non-environmental (no Grommet or Seal)	A	GPRBN22SA	1738149-2			
			B	GPRBN22SB	1738154-2			
		22V	Pin	Environmental, with Rear Grommet & Interfacial Seal	A	GPRBE22VPA	2033990-1	
					B	GPRBE22VPB	2033995-1	
Socket	Environmental, with Rear Grommet		A	GPRBE22VSA	2000126-1			
			B	GPRBE22VSB	2033996-1			

Insert Descriptive Part Number Format (Continued)

GPRB Insert Part Numbers (Continued)

Series	Contact Arrangement	Contact Type	Classification	Keying	Descriptive Part Number	TE Part Number		
B	28	Pin	Environmental, with Rear Grommet & Interfacial Seal	A	GPRBE28PA	1738156-1		
				B	GPRBE28PB	1738161-1		
			Insert with Rear Grommet, without Interfacial Seal	A	GPRBH28PA	1738157-1		
				B	GPRBH28PB	1738162-1		
			Non-environmental (no Grommet or Seal)	A	GPRBN28PA	1738158-1		
				B	GPRBN28PB	1738163-1		
		Socket	Environmental, with Rear Grommet	A	GPRBE28SA	1738159-1		
				B	GPRBE28SB	1738164-1		
			Non-environmental (no Grommet or Seal)	A	GPRBN28SA	1738160-1		
				B	GPRBN28SB	1738165-1		
			30	Pin	Environmental, with Rear Grommet & Interfacial Seal	A	GPRBE30PA	1738166-1
						B	GPRBE30PB	1738171-1
		Insert with Rear Grommet, without Interfacial Seal			A	GPRBH30PA	1738167-1	
					B	GPRBH30PB	1738172-1	
		Non-environmental (no Grommet or Seal)			A	GPRBN30PA	1738168-1	
					B	GPRBN30PB	1738173-1	
		Socket	Environmental, with Rear Grommet	A	GPRBE30SA	1738169-1		
				B	GPRBE30SB	1738174-1		
			Non-environmental (no Grommet or Seal)	A	GPRBN30SA	1738170-1		
				B	GPRBN30SB	1738175-1		
			34	Pin	Environmental, with Rear Grommet & Interfacial Seal	A	GPRBE34PA	1738176-1
						B	GPRBE34PB	1738181-1
		Insert with Rear Grommet, without Interfacial Seal			A	GPRBH34PA	1738177-1	
					B	GPRBH34PB	1738182-1	
	Non-environmental (no Grommet or Seal)	A			GPRBN34PA	1738178-1		
		B			GPRBN34PB	1738183-1		
	Socket	Environmental, with Rear Grommet		A	GPRBE34SA	1738179-1		
				B	GPRBE34SB	1738184-1		
		Non-environmental (no Grommet or Seal)		A	GPRBN34SA	1738180-1		
				B	GPRBN34SB	1738185-1		
		40		Pin	Environmental, with Rear Grommet & Interfacial Seal	A	GPRBE40PA	1738186-1
						B	GPRBE40PB	1738191-1
	Insert with Rear Grommet, without Interfacial Seal		A		GPRBH40PA	1738186-2		
			B		GPRBH40PB	1738191-2		
	Non-environmental (no Grommet or Seal)		A		GPRBN40PA	1738186-3		
			B		GPRBN40PB	1738191-3		
	Socket		Environmental, with Rear Grommet	A	GPRBE40SA	1738189-1		
				B	GPRBE40SB	1738194-1		
			Non-environmental (no Grommet or Seal)	A	GPRBN40SA	1738189-2		
				B	GPRBN40SB	1738194-2		
			48	Pin	Environmental, with Rear Grommet & Interfacial Seal	A	GPRBE48PA	2102227-1
						B	GPRBE48PB	2102227-2
	Insert with Rear Grommet, without Interfacial Seal	A			GPRBH48PA	2102227-3		
		B			GPRBH48PB	2102227-4		
	Insert with Interfacial Seal Only	A			GPRBT48PA	2102228-1		
		B			GPRBT48PB	2102228-2		
	Socket	Non-environmental (no Grommet or Seal)		A	GPRBN48PA	2102229-1		
				B	GPRBN48PB	2102229-2		
Environmental, with Rear Grommet		A		GPRBE48SA	2102229-3			
		B		GPRBE48SB	2102229-4			
Non-environmental (no Grommet or Seal)		A		GPRBN48SA	2102230-1			
		B		GPRBN48SB	2102230-2			

Insert Descriptive Part Number Format (Continued)

GPRB Insert Part Numbers (Continued)

Series	Contact Arrangement	Contact Type	Classification	Keying	Descriptive Part Number	TE Part Number
B	25P1	Pin	Environmental, with Rear Grommet & Interfacial Seal	A	GPRBE25P1PA	2000108-1
				B	GPRBE25P1PB	2033997-1
		Socket	Environmental, with Rear Grommet	A	GPRBE25P1SA	2033989-1
				B	GPRBE25P1SB	2033998-1
	25Q1	Pin	Environmental, with Rear Grommet & Interfacial Seal	A	GPRBE25Q1PA	1811121-1
				B	GPRBE25Q1PB	1877567-1
		Socket	Environmental, with Rear Grommet	A	GPRBE25Q1SA	1811122-1
				B	GPRBE25Q1SB	1877568-1
	10Q2	Pin	Environmental, with Rear Grommet & Interfacial Seal	A	GPRBE10Q2PA	1877702-1
				B	GPRBE10Q2PB	1877706-1
			Non-environmental (no Grommet or Seal)	A	GPRBN10Q2PA	2000143-1
		Socket	Environmental, with Rear Grommet	A	GPRBE10Q2SA	1877704-1
				B	GPRBE10Q2SB	1877708-1
			Non-environmental (no Grommet or Seal)	A	GPRBN10Q2SA	1954067-1
	3Q3	Pin	Environmental, with Rear Grommet & Interfacial Seal	A	GPRBE3Q3PA	1877694-1
				B	GPRBE3Q3PB	1877698-1
		Socket	Environmental, with Rear Grommet	A	GPRBE3Q3SA	1877696-1
				B	GPRBE3Q3SB	1877700-1
	F12	ARINC 801 Termini	Environmental, without Sleeve Holder	A	GPRBEF12PA	1738805-1
				B	GPRBEF12PB	1738806-1
			Environmental, with Sleeve Holder	A	GPRBEF12SA	1738807-1
				B	GPRBE2F12SB	1738808-1
	F12C	ARINC 801 Termini	Environmental, without Sleeve Holder	A	GPRBEF12CPA	2000856-1
				B	GPRBEF12CPB	2000857-1
Environmental, with Sleeve Holder			A	GBRBEF12CSA	2000858-1	
			B	GPRBF12CSB	2000859-1	
12F6	ARINC 801 Termini	Environmental, without Sleeve Holder	A	GPRBE12F6PA	2000860-1	
			B	GPRBE12F6PB	2000861-1	
		Environmental, with Sleeve Holder	A	GPRBE12F6SA	2000862-1	
			B	GPRBE12F6SB	2000863-1	
M2	Mini-Expanded Beam	Spring-loaded Half	A	GPRBEM2PA	1445162-1	
			B	GPRBEM2PB	2000189-1	
		Fixed Half	A	GPRBEM2SA	1445163-1	
			B	GPRBEM2SB	2000190-1	

Insert Arrangements

GPR Inserts¹



00
Dummy Insert

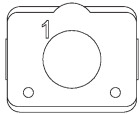

1C1
1 x Size 5 Contacts

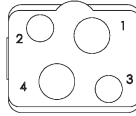

04
2 x Size 15 or 16 Contacts
2 x Size 12 Contacts

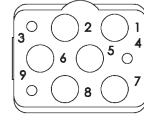

09
3 x Size 20 Contacts
6 x Size 15 or 16 Contacts

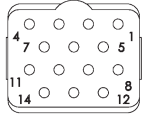

14
14 x Size 20 Contacts

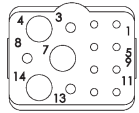

14M
8 x Size 22 Contacts
3 x Size 20 Contacts
3 x Size 15 or 16 Contacts

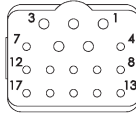

17
12 x Size 22 Contacts
5 x Size 20 Contacts

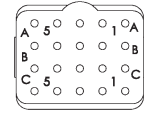

20
20 x Size 22 Contacts

Note

¹ Pin inserts: Mating faces shown above.

² In a GPRB2 shell, one insert must be "A" keyed and the other one must be "B" keyed (See at right).

³ Size 8 cavity applicable for use with ARINC 600 Quadrax or Twinax contacts.

Insert Arrangements (Continued)

GPRB Inserts^{1, 2}



00
Dummy Insert

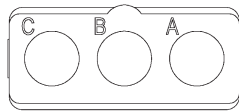

C3
3 x Size 5 Coax Contacts

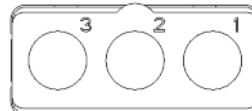

P3
3 x Size 5 Power Contacts

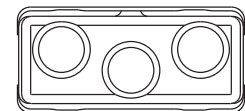

3Q3³
3 x Size 8 Quadrx Contacts

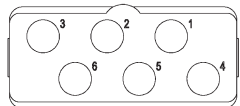

06
6 x Size 12 Contacts

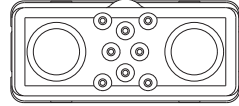

10Q2³
8 x Size 20 Contacts
2 x Size 8 Quadrx Contacts

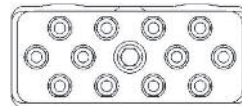

12F6
6 x size 16 Optical ARINC 801 termini
6 size 16 special electrical contacts

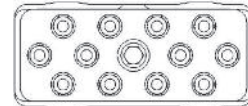

F12C
(high grade thermoplastic)
12 x size 16
Optical ARINC 801 termini

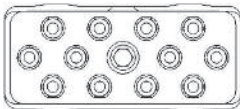

F12 (aluminum)
12 x size 16
Optical ARINC 801 termini

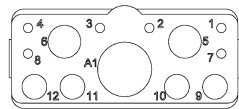

13C1
2 x Size 12 Contacts
4 x Size 15 or 16 Contacts
6 x Size 20 Contacts
1 x Size 5 Coax Contacts

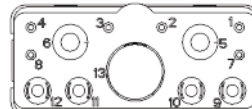

13P1
2 x Size 12 Contacts
4 x Size 15 or 16 Contacts
6 x Size 20 Contacts
1 x Size 5 Power Contacts

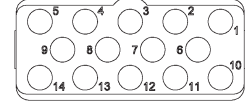

14
14 x Size 15 or 16 Contacts

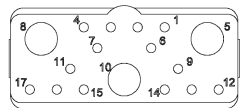

17
14 x Size 20 Contacts
3 x Size 12 Contacts

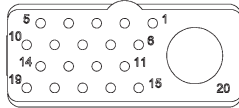

20C1
19 x Size 20 Contacts
1 x Size 5 Coax Contacts



20P1
19 x Size 20 Contacts
1 x Size 5 Power Contacts

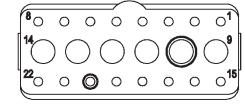

22
16 x Size 20 Contacts
6 x Size 15 or 16 Contacts

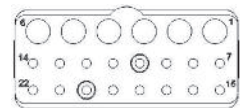

22V
16 x size 20 contacts
6 x size 16 contacts

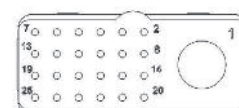

25PI
24 x size 22 contacts
1 size 8 power contacts

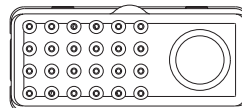

25Q1³
24 x Size 22 Contacts
1 x Size 8 Quadrx Contacts

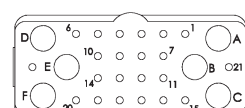

28
22 x Size 22 Contacts
6 x Size 15 or 16 Contacts

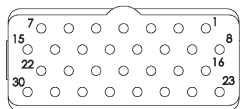

30
30 x Size 20 Contacts

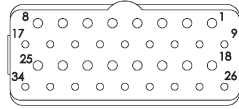

34
18 x Size 22 Contacts
16 x Size 20 Contacts

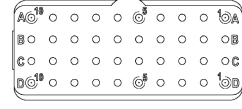

40
40 x Size 22 Contacts

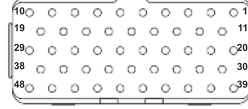

48
48 x Size 22 Contacts

Bussed inserts available for arrangements 13, 30, and 40.
Contact TE Connectivity.
Mini Expanded Beam inserts - see page 8-25

Note

- ¹ Pin inserts: Mating faces shown above.
- ² In a GPRB2 shell, one insert must be "A" keyed and the other one must be "B" keyed (See at right).
- ³ Size 8 cavity applicable for use with ARINC 600 Quadrx or Twinax contacts.

Keying:



Insert Assemblies for High Speed Applications

**F12, F12C & 12F6
ARINC 801 Insert
Assemblies**



Product Facts

- F12C inserts now available in composite material
- ARINC 801 approved
- Optical termini for use with GPR, ARINC 600, circular MIL-DTL-38999 connectors.
- Industry Standard 1.25 mm ceramic ferrule
- Compatible with 1.5-2.2 mm tight jacket and loose tube cable construction:
 - MT - Tight jacket cable
 - ML – Loose tube cable
- Single mode (SM) and Multimode (MM) versions
- ARINC 801 termini part numbers: 1828199-1 MM/ML Version 1828200-1 MM/MT Version 1918614-1 SM/ML Version 1918616-1 SM/ML Version-APC 1918615-1 SM/MT Version 1918617-1 SM/MT Version - APC

Materials:

- Housings** – Nickel Plated Copper
- Ferrule** – Zirconia
- Spring** – Stainless Steel
- Crimp Sleeve** – Nickel Plated Copper
- Protective Cover** – Silicone

Optical Performance

- Single mode**, 1310 nm/1550 nm (UPC)
 - Attenuation, Mean** – 0.15 dB
 - Return Loss** - >50 dB
- Multimode**, 850 nm, 1310 nm
 - Attenuation, Mean** – 0.10 dB
 - Return Loss** - >20 dB

Assembly Capabilities

TE has extensive Rugged Optic Harness capabilities. Please consult your local TE Sales Representative for assistance.

Insert Assembly, without Sleeve Holder,
Environmental
Aluminum Housings, F12
Key A 1738805-1
Key B 1738806-1

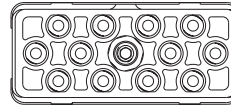

Composite Housings, F12C
Key A 2000856-1
Key B 2000857-1

Insert Assembly, with Sleeve Holder,
Environmental,
Aluminum Housings, F12
GPRB
Key A 1738807-1
Key B 1738808-1

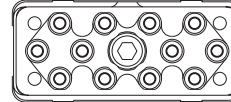

Composite Housings, F12C
Key A 2000858-1
Key B 2000859-1

Insert Assembly, without Sleeve Holder,
Environmental, 12F6
GPRB
Key A 2000860-1
Key B 2000861-1

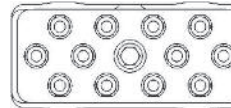

Insert Assembly, with Sleeve Holder,
Environmental, 12F6
Key A 2000862-1
Key B 2000863-1

ARINC 801 Cavity Reducers

Size 8 Quadrax	Part Number	ARINC 801 Cavity Reducer
Pin Quadrax adapter for ARINC 801 termini in Quadrax FR type cavity	1757727-1	Quadrax cavity reducer (FR/FR) for receptacle shell
Pin Quadrax adapter for ARINC 801 termini in Quadrax RR type cavity	1757710-1	Quadrax cavity reducer (RR/RR) for receptacle shell
Socket Quadrax adapter for ARINC 801 termini in Quadrax RR type cavity	1757711-1	Quadrax cavity reducer (RR/RR) for plug shell

ARINC 801 Optical Termini Part Numbers

Cable Dia.	Cable Structure ML (loose & tight) MT (ultra tight)	S/M Fiber 125.3 µm PC/UPC	S/M Fiber 125.3 µm APC	M/M Fiber 128 µm PC
0.9 mm Buffer	—	*	*	*
1.5 - 2.2 mm	ML	1918614-1	1918616-1	1828199-1
1.5 - 2.2 mm	MT	1918615-1	1918617-1	1828200-1

Consult your local TE Sales Representative for additional options.
* Contact TE for availability.

Insert Assemblies for High Speed Applications (Continued)

M2 Mini-Expanded Beam Insert Holders

Product Facts

- No wear on fiber optic interface; Very vibration resistant
- Easy to handle, easy to clean. Durable connection that is highly resistant to dirt/debris.
- Singlemode or multimode
- Common 850/1300 dual wavelength, 1310 nm, or 1550 nm wavelengths
- Easy alignment for low-loss repeatable performance
- Consistent overall optical “link budget” assured
- Low sensitivity to thermal fluctuations and interface contamination
- Repeatable low-loss performance in harsh environments.

Expanded Beam Products

- Ball lens expands cross-sectional area of light over 200 times for multimode and over 2000 times for singlemode
- Rugged hermaphroditic construction (i.e., same insert mates to each other)
- Physically non-contacting mating conditions; no wear, installed fiber ferrule protected by ball lens
- PRO BEAM Mini Connector field deployable interconnects
- Insert/holder blocks designed for Mini-Expanded Beam
- Common insert for 1- through 4-channels
- Unique Modular Design, for use with multimode and singlemode fiber.
- Cable assembly and termination services

Expanded Beam Insert

- Mini-Expanded Beam insert for multi-channel small form factor – the smallest expanded beam multi-channel insert in the industry a TE Connectivity exclusive.

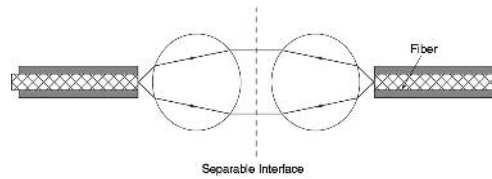

Expanded Beam Principle

Fiber Optic interconnect/cable system using Expanded Beam technology, which physically expands and collimates the transmission signal into an optical beam over 14 times its original diameter (the cross sectional area of the light beam increases over 200 times for multimode optical signals). For singlemode signals, the collimated beam is over 45 times its original diameter

(the cross-sectional area of the light beam increases over 2,000 times). It is then refocused back down onto the core of the receiving fiber. This approach provides ease of alignment and low sensitivity to thermal changes and contamination. High strength, precision connector housings enhance a durable connection, optimizing low loss and repeatable performance.

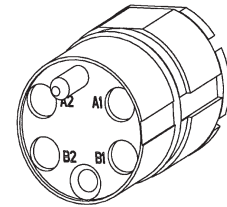

Expanded Beam Inserts

Suitable for aerospace, avionics, field-deployable communications, marine ship-to-shore applications, security systems, mobile diagnostic units, oil and gas exploration and other harsh environment applications demanding strength, durability and reliable performance in conditions of multiple couplings/decouplings, blindmate situations, and high vibration.

Assembly Capabilities

TE has extensive Rugged Optic Harness capabilities. Please consult your local TE Sales Representative for assistance.

Insert Assemblies for High Speed Applications (Continued)

M2 Mini-Expanded Beam Insert Holders
(Continued)

**Holder Kit, Pin (Spring-Loaded),
Mini-Expanded Beam**
Key A – GPRB-1445162-1
Key B – GPRB-2000189-1

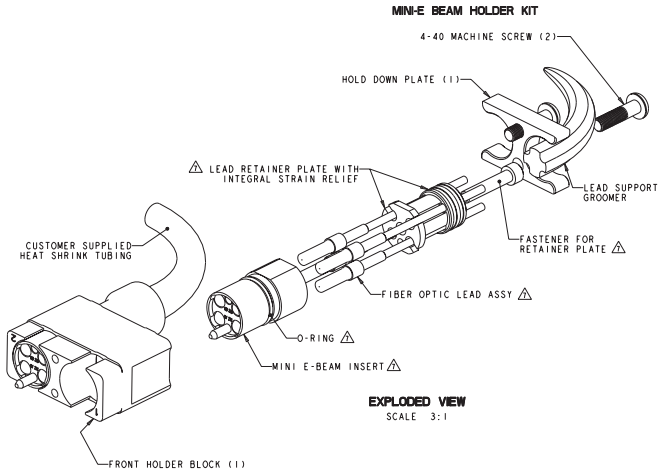
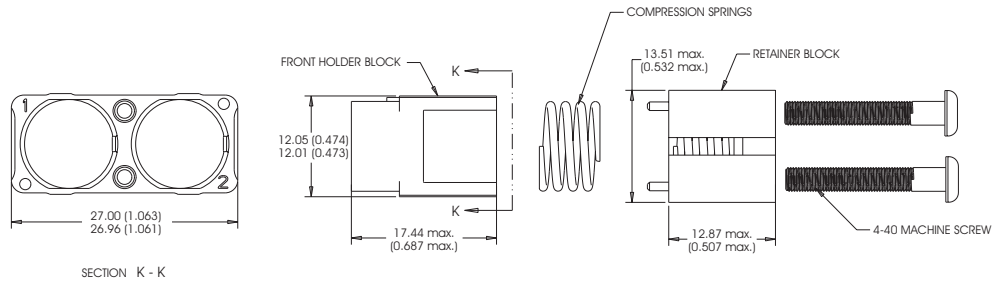

**Holder Kit, Socket (Fixed),
Mini-Expanded Beam,**
Key A – GPRB-1445163-1
Key B – GPRB-2000190-1

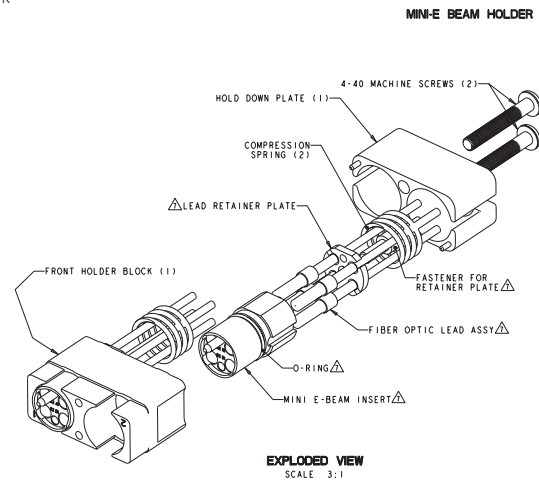
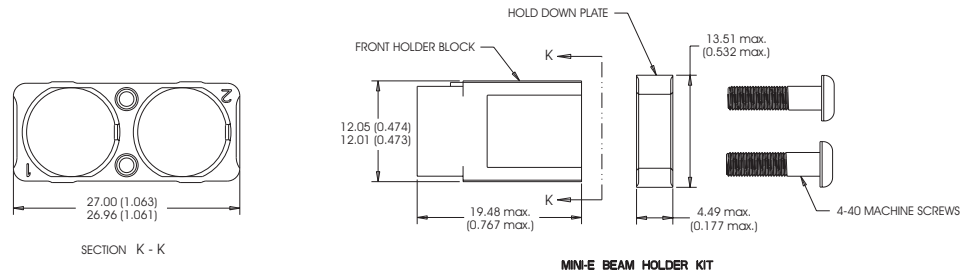

Insert Assemblies for High Speed Applications (Continued)

24 Position Fiber Optic Connector

for use with ARINC 801 termini

Application Specification:

114-13192

Product Specification:

108-2247

Qualification Test Report:

501-680

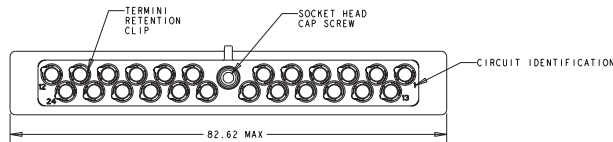
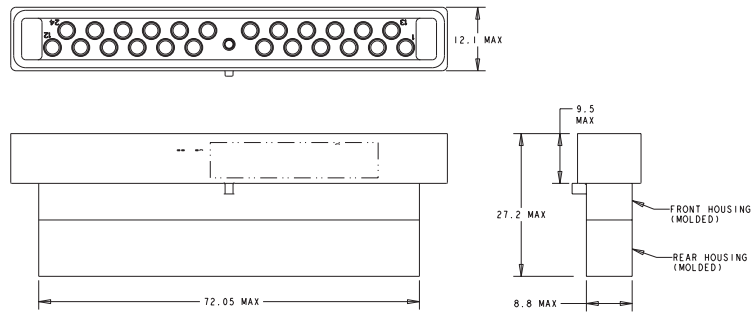

**Backplane Connector Kit
1738969-1**

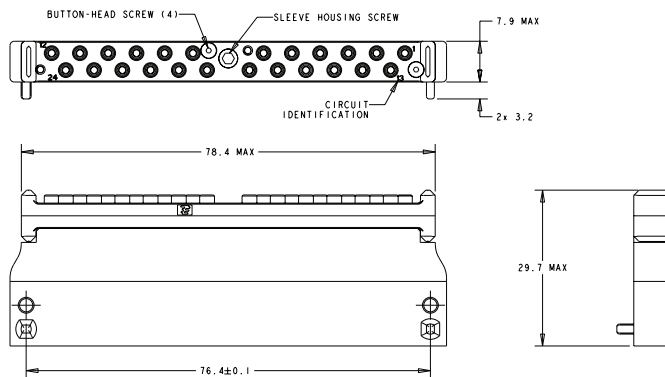

**Module Connector
1738960-2**

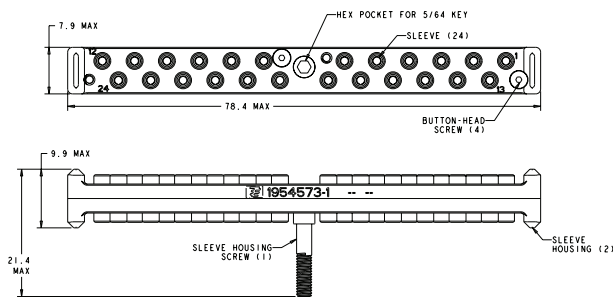

**Sleeve Holder Assembly
1954573-1**

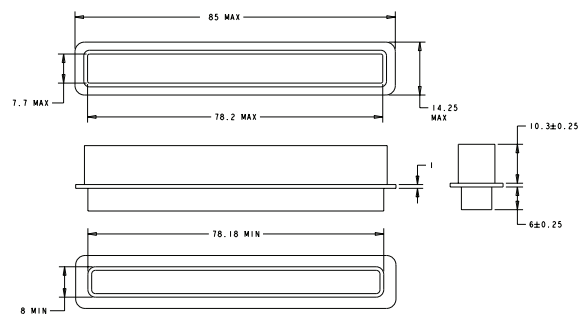

**Dust Cover
1877519-1**



General Purpose Rectangular (GPR) Connectors

Contact and Application Tool Part Numbers

Form	Contact Size	Wire Size	Type	Contacts TE P/N	Contact Crimp Tools & Positioners				Contact Insertion/Removal Tools		
					Crimp Tool TE P/N	Crimp Tool MIL P/N	Positioner TE P/N	Positioner MIL P/N	TE Part Number	MIL Part Number	
Crimp Contacts	22	22 - 24 - 26	Pin	1738007-1	601966-1	M22520/2-01	601966-8	M22520/2-23	91066-1	M81969/1-01	
			Socket	1738008-1							
			Socket*	1954077-2							
	22 - Reduced Crimp Barrel	28 - 30	Pin	1738009-1	601966-1	M22520/2-01					
			Socket	1738010-1							
	20	20 - 22 - 24	Pin	1738011-1			601966-5	M22520/2-08	91067-2	M81969/1-02	
			Socket	1738012-1							
	16	16 - 18 - 20	Pin	1738013-1					91066-3	M81969/1-03	
			Socket	1738014-1							
	16 - Reduced Crimp Barrel	20 - 22 - 24	Pin	1738015-1	601967-1	M22520/1-01	601967-2	M22520/1-02			
			Socket	1738016-1							
	12	12 - 14	Pin	1738017-1					1738327-1	M81969/28-02	
			Socket	1738018-1							
	8	8 - 10	Pin	1996474-1					58284-1	M81969/28-03	
			Socket	1996475-1							
5	8 - 10	Pin	1738019-1	N/A	M22520/23-01 & M22520/23-02	Locator 1738331-1	N/A	91074-1	M81969/28-01		
		Socket	1954722-1								
16 - Mating End 20-Crimp Barrel	20 - 22 - 24	Ground Block Contact	2-592404-1 M39029/1-101	601966-1	M22520/2-01	N/A	M22520/2-02 or /2-11	592105-1	M81969/14-11 or /14-02		
Form	Contact Size	Wire Size	Type	Contacts TE P/N	Center Conductor / Contact Crimp Tools & Positioners			Outer Conductor Crimp Tools & Die Sets		Contact Insertion/Removal Tools	
					Crimp Tool TE P/N	Crimp Tool MIL P/N	Positioner TE P/N MIL P/N	Crimp Tool TE P/N MIL P/N	Die Set TE P/N MIL P/N	TE P/N	MIL P/N
Coaxial Crimp Contacts	5	RG142 RG223 KX23	Pin	1738021-1							
			Socket	1738022-1							
	5	RG174 RG316 KX22	Pin	1738023-1	601966-1	M22520/2-01	1738332-1 N/A	608650-1 M22520/5-01	1738336-1 M22520/5-05	91074-1	M81969/28-01
			Socket	1738024-1							
	15	RG174 RG179 RG316 - KX22	Pin	1738025-1							
			Socket	1738026-1							
	15	RG178 KX21 ST	Pin	1738027-1			1738333-1 N/A	601963-1 M22520/4-01	1738337-1 N/A	91066-3	M81969/1-03
			Socket	1738028-1							
	15	KX21 DT	Pin	1738029-1							
			Socket	1738030-1							
15	UT .047	Pin	1738031-1								
		Socket	1738032-1								
Concentric Twinax Crimp Contacts	5	PAN61421 M17/176-0002	Pin	1738033-1	608650-1	M22520/5-01	1738338-1 N/A	608650-1 M22520/5-01	1738336-1 M22520/5-05	91074-1	M81969-28-01
			Socket	1738034-1							

* Economy socket

Contact and Application Tool Part Numbers (Continued)

Form	Contact Size	Hex Crimp Number	Reference Cables	Type	Contacts PN	Contact Insertion/Extraction
ARINC 600 QUADRAX Contacts	8	0.218	Tensolite NF24Q100, NF26Q100, 24443/03130X-4 (LD), 2443/P025X-4 (LD), Raychem CEC-RWC-18687, CEC-RWC-18664	Pin	1445692-1	
				Socket	1445693-1	
				Pin	1445692-6	
		0.231	DRAKA F4703-3, F4704-4	Socket	1445693-6	
				Pin	1877039-1	
				Socket	1877040-1	
Differential Pair TWINAX Contacts	8	—	Raychem 100 ohm Twinaxial 0024T1426	Seal Assembly	1877626-2	M81969/28-03
				Pin	1811865-1	
				Socket	1811866-1	
Differential Pair TWINAX Contacts	8	—	Raychem 120 ohm Twinaxial 1726A1424	Seal Assembly	1954046-1	
				Pin	1811865-3	
				Socket	1811866-3	
				Seal Assembly	1954046-1	

ARINC 801 Optical Termini Part Numbers

Cable Dia.	Cable Structure ML (loose & tight) MT (ultra tight)	S/M Fiber 125.3 µm PC/UPC	S/M Fiber 125.3 µm APC	M/M Fiber 128 µm PC
0.9mm Buffer	—	*	*	*
1.5 - 2.2mm	ML	1918614-1	1918616-1	1828199-1
1.5 - 2.2mm	MT	1918615-1	1918617-1	1828200-1

Consult your local TE Sales Representative for additional options.
* Contact TE for availability.

PC Tail Contacts

Inserts pre-assembled with PC tail contacts with straight or right-angle termination are available — Consult TE.

Posted Contacts – Rear Release/Remove

Form	Contact Size	Type	Tail Diameter	Tail Length	Part Number
Posted Contacts	22	Pin	0.63	12.6	1738709-1
	20	Pin	0.63	13.35	1738710-1
	16	Pin	1.32	14.45	1996452-2
	12	Pin	2.03	13.60	1738711-1
	8	Pin	4.04	26.63	2000499-1
	5	Pin	4.55	26.66	2000500-1

Right Angle Posted Pin Contact / Insert Assemblies

Form	Insert Arrangement	Part Number
Insert assemblies with right-angle pin contacts installed; insert assy. also includes pin spacer	06 GPRBE06PA	1996453-1
	GPRBE06PB	1996453-2
	40 GPRBE40PA	1996454-1
	GPRBE40PB	1996454-2
	25Q1* GPRBE25Q1PA	1996481-1
	GPRBE25Q1PB	1996481-2

*with Twinax contact installed in Size 8 cavity
Other insert arrangements available upon request.

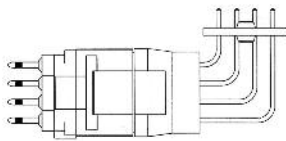

Spare Parts and Tools

Spare Parts

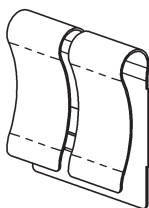

Grounding Spring
Part Number 1738199-1

GPR and GPRB Series

Part Number	Description	To Be Used With
1738199-1	Grounding Spring	GPR
1738200-1	Dust Cap – Plug Shell	GPR
1738201-1	Dust Cap – Receptacle Shell	GPR
1738203-1	Jacknut – A/B/C/D/E/F	GPRB2
1738204-1	Jacknut – N/R/W/X/Y/Z	GPRB2
1738205-1	Jackscrew – A/B/C/D/E/F	GPRB2
1738206-1	Jackscrew – N/R/W/X/Y/Z	GPRB2
1738207-1	Polarizing Guide Socket – A/B/C/D/E/F	GPRB2 Rack & Panel application
1738208-1	Polarizing Guide Socket– N/R/W/X/Y/Z	GPRB2 Rack & Panel application
1738209-1	Polarizing Guide Post – A/B/C/D/E/F	GPRB2 Rack & Panel application
1738210-1	Polarizing Guide Post – N/R/W/X/Y/Z	GPRB2 Rack & Panel application
1738213-1	Dust Cap – Plug Shell	GPRB1
1738214-1	Dust Cap – Receptacle Shell	GPRB1
1738211-1	Dust Cap – Plug Shell	GPRB2
1738212-1	Dust Cap – Receptacle Shell	GPRB2
1877328-1	Anti-Static Dust Cap – Plug Shell	GPRB2
1877329-1	Anti-Static Dust Cap – Receptacle Shell	GPRB2
1738400-1	Grounding Spring	GPRB1 & B2
1738428-1	Polarization Key, Male	GPR & legacy GPRB1
1738429-1	Polarization Key, Female	GPR & legacy GPRB1
1738440-1	Key Retention Plate Assembly	GPR & legacy GPRB1
1877985-1	Polarization Key, Pin	GPRB1 (for flexible sidewall design)
1877986-1	Polarization Key, Socket	GPRB1 (for flexible sidewall design)

Tools

GPR and GPRB Series

Part Number	Description	To Be Used With
1738215-1	Insert extraction tool	GPR
1738216-1	Allen wrench locking system	GPR, GPRB1
1738217-1	Insert handling case	GPR, GPRB1 & B2
1738218-1	Insert extraction tool	GPRB1 & B2
1738219-1	Right-angle insert extraction tool	GPRB1 & B2
1738220-1	Spanner wrench for locking device w/1/4 inch adapter	GPRB2
1738221-1	Spanner wrench for locking device w/handle	GPRB2

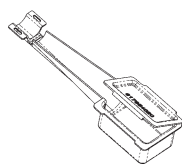

Insert Handling Case
Part Number 1738217-1

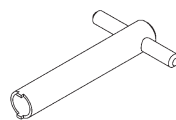

Spanner Wrench for Locking Device
with Handle
Part Number 1738221-1

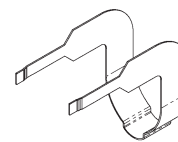

Right-Angle Insert Extraction Tool
Part Number 1738219-1

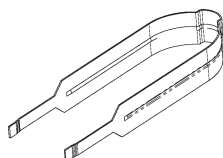

Insert Extraction Tool
Part Number 1738218-1



Stainless steel testing tools are available to check the wiring of the inserts without the shell — Consult TE.

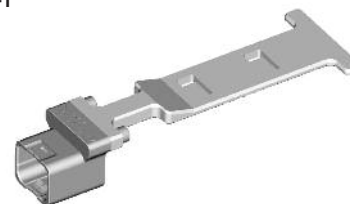

EMI Backshells and Strain Reliefs

GPRB Series

Part Number	Description	Used With
1738310-1	Straight strain relief	GPRB1
1738311-1	45° strain relief	GPRB1
1738312-1	Straight backshell	GPRB1
1738313-1	Straight strain relief	GPRB2
1738314-1	Backshell for shielded termination	GPRB2
1738315-1	Backshell for screened twisted-pair cables	GPRB2
1738316-1	Backshell for large sized wire harnesses	GPRB2
1811650-1	Straight Strain Relief	GPRB2-Vertical

GPRA Series

Part Number	Description
1738317-1	Straight strain relief
1738318-1	45° strain relief
1738319-1	Straight backshell

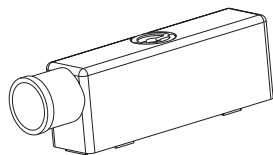

Backshell Kit, 90° Exit Contact TE

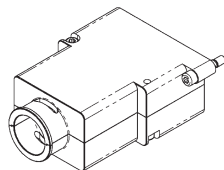

Straight Backshell Part Number 1738312-1

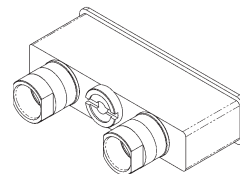

Backshell for Shielded Termination Part Number 1738314-1

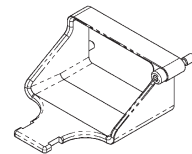

Straight Strain Relief Part Number 1738310-1

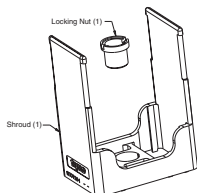

Vertical Strain Relief Kit, Fiber Optic Part Number 1877736-1

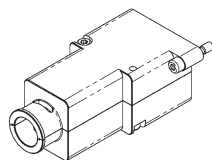

Straight Backshell Part Number 1738319-1

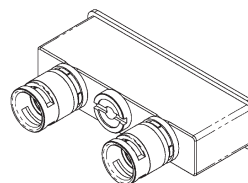

Backshell for Screened Twisted Pair Cables Part Number 1738315-1

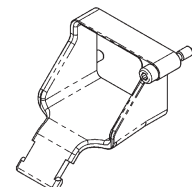

45° Strain Relief Part Number 1738318-1

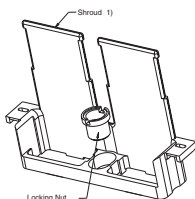

Horizontal Strain Relief Kit, Fiber Optic Part Number 1877888-1

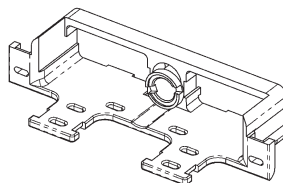

Straight Strain Relief Part Number 1738313-1

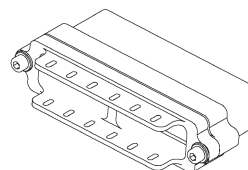

Backshell for Large Sized Wire Harnesses Part Number 1738316-1

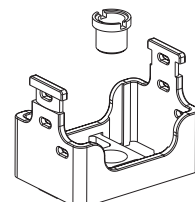

GPRB2 Vertical Strain Relief Part Number 1811650-1

Galley Insert (GAIN) Connectors



Product Facts

- Designed for ARINC 810 – standard interfaces for Galley Insert (GAIN) Equipment
- Spring-Loaded, float-mounting plug shell design allows ±1 mm variation in the mating direction
- Blind mating guide pin & socket accept ±2 mm/ 2° lateral misalignment
- Product incorporates:
 - Size 22 signal contacts
 - Size 12 power contacts
 - Size 8 twinax contacts
- 500 mating cycles durability

Application Specification:

114-13220

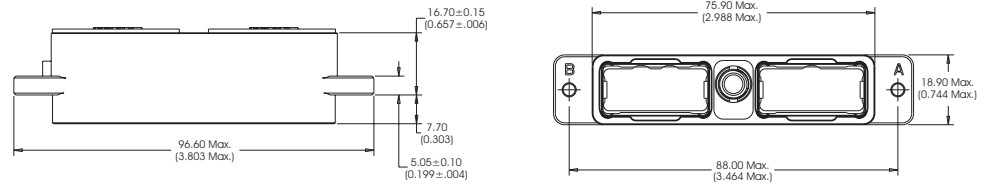

Receptacle Shell, Front Panel Mount, with Guide Socket
GPRB2
1811119-1

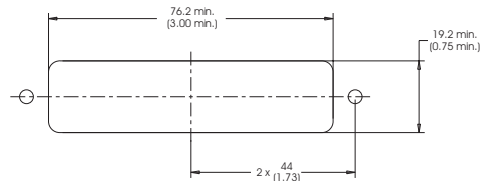

Recommended Panel Cutout

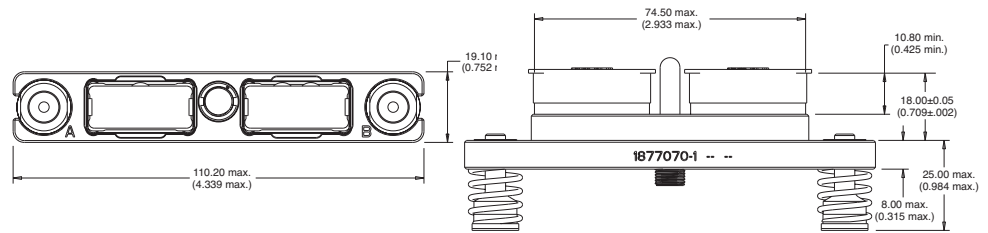

Plug Shell, Spring-Loaded, Float-Mounting
GPRB2
1877070-1

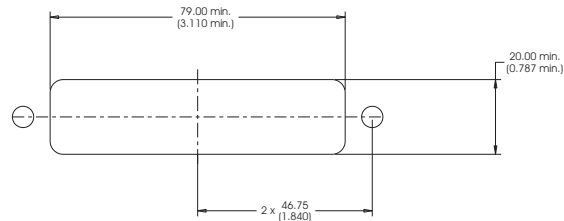

Recommended Panel Cutout

Description	Part Number	Ref. Catalog Page
Fully Assembled Receptacle	1877652-1	8-32
Fully Assembled Plug	1877646-1	8-32
Receptacle Shell Assembly	1811119-1	8-32
Plug Shell Assembly	1877070-1	8-32
25Q1 Pin Insert Assembly	1811121-1	8-20, 8-32
25Q1 Socket Insert Assembly	1811122-1	8-20, 8-32
06 Pin Insert Assembly	1738101-1	8-18, 8-32
06 Socket Insert Assembly	1738104-1	8-18, 8-32
Size 22 Pin Contact	1738007-1	8-28, 8-32
Size 22 Socket Contact	1738008-1	8-28, 8-32
Size 12 Pin Contact	1738017-1	8-28, 8-32
Size 12 Socket Contact	1738018-1	8-28, 8-32
Size 8 Twinax Pin Contact	1811865-3	8-28, 8-31
Size 8 Twinax Socket Contact	1811866-3	8-29, 8-32
Size 22 Sealing Plug	592104-4	8-32
Strain Relief (Straight)	1738313-1	8-31, 8-32
Dust Cap, Plug	1738211-1	8-30, 8-32
Dust Cap, Receptacle	1738212-1	8-30, 8-32
Seal Assembly, Size 8, GPR	1954046-1	8-29, 8-32
120 Ohm Twinaxial Cable	1726A1424	8-29

Custom Shells

Custom Shells

This custom 4-cavity receptacle shell was developed and serves as the rear panel of the customer's enclosure.



GPRB4 (Horizontal) Shell Dimensions

Shell Kits with Four Cavities

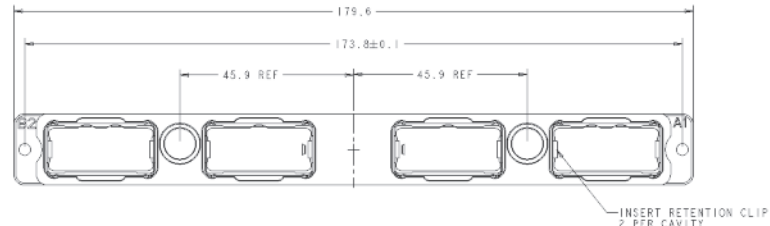
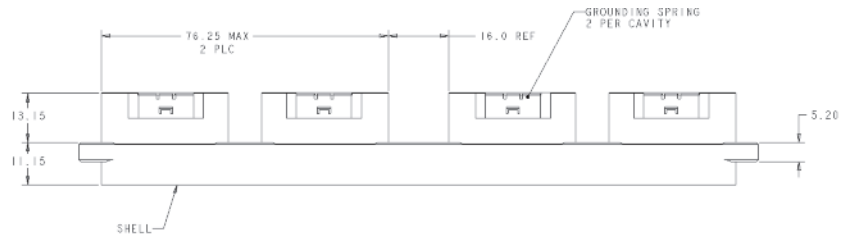

**Receptacle, w/(2) thru holes
1996487-1**

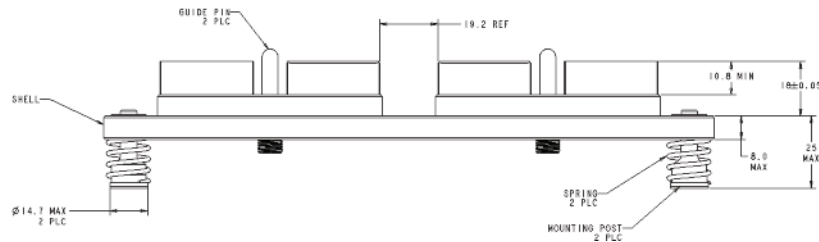
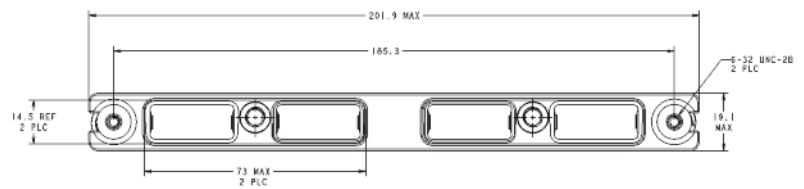

**Plug, w/ spring loaded float mount
1996488-1**

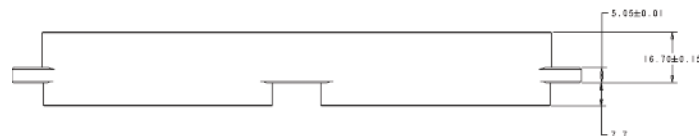
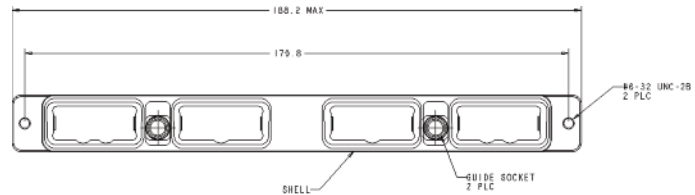

Receptacle, front panel mount, w/(2) 6-32 holes



Custom Solutions and In Development Products

The GPRA & B Connector Series offers a comprehensive range of standard components that allows the user to build a connector to meet his requirements. However, standard shells might not be compatible with the user's application;

alternate solutions are available to meet the customer's specific requirements with limited investment by using standard inserts and contacts. Some of these are shown below.

Multicavity Racked Shells

GPRB shells can be built in any format from 4 to 20 cavities for either panel or rack applications and with or without grounding blocks. These shells accommodate standard inserts.



Solution for IMA (Integrated Modular Avionics)

A right-angle contact printed circuit board connector which allows direct mating with an airframe connector has been developed. It is fitted with special rack features: spring loaded shell, EMI shield frame and 4 polarization posts with 256 combinations.

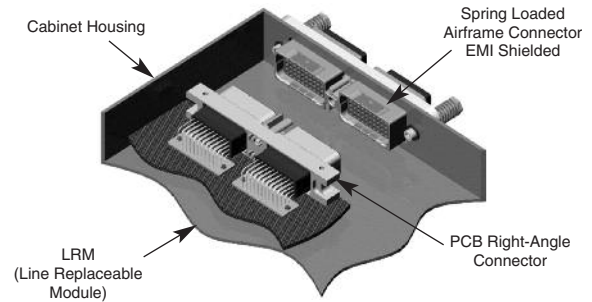

Composite Shells (in development)

Low weight, Skydrol® resistant composite shells have been developed.

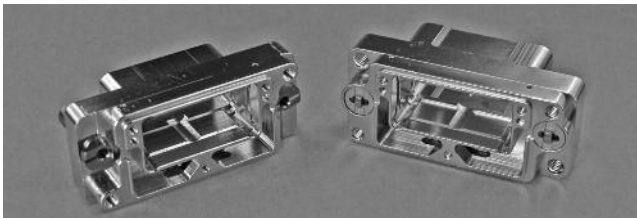

High Density Insert - 48 Position

To save space and weight and to accommodate density demand in electronic equipment.

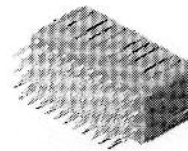

Custom Inserts

Inserts are available with PC Tail contacts pre-assembled, such as this 40-position pin assembly.

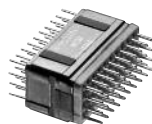

SKYDROL is a registered trademark of Solutia Inc.