

REVISIONS					
REV	CLM	DESCRIPTION	DATE	OWN	APVD
B2	ADDED -8	ECR-17-004035	22MAR2017	RK	TK
B3	REVISED	ECR-16-003437	17APR2017	KF	TK
B4	OBSOLETE -1	ECR-19-013045	31MAR2020	DM	HK
B5	REVISED PER	ECR-23-188923	11SEP2023	KW	RK

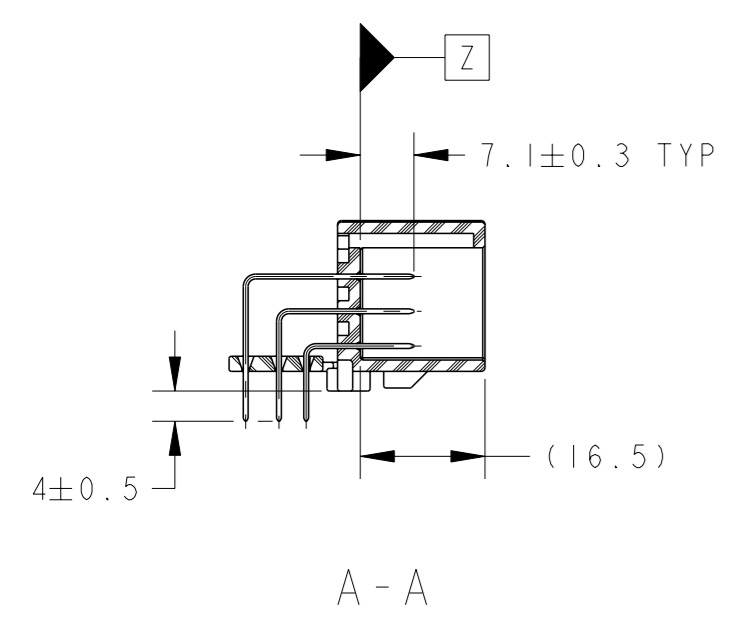

- △ MEASURED AT THE SECTION 2mm FROM Z.
- 2. PART NO PLUG HOUSINGS TO BE MATED
17P: 353027
22P: 353028
24P: 353029
31P: 353031
- 3. RECOMMENDED SCREW: PAN-HEADED, TYPE 2 TAPPING SCREW OF 3DIA X 6LEN(MAX) (JIS B1115, B1122).
- 4. FASTENING TORQUE FOR SCREW: 0.392N·m MAX.
- △ TINE PLATE COLOR: NATURAL
- △ MARKING FOR DISCERNMENT OF THE CONTACTS FINISH, SEE TABLE
- △ CIRCUIT NUMBER REFERRED TO Fig 1.

- △ Z軸より2mmの位置で測定
- 2. 嵌合相手ハウジング型番
17P: 353027
22P: 353028
24P: 353029
31P: 353031
- 3. 推奨取り付けねじ: JIS B1115, B1122タッピングねじ、ねじ2種、呼び径3、長さ6以下
- 4. ねじ締め付トルク: 0.392N·m MAX.
- △ タイン・プレートの色は、自然色
- △ コンタクト仕上識別用マーク: 表参照
- △ 回路番号は Fig 1 参照のこと

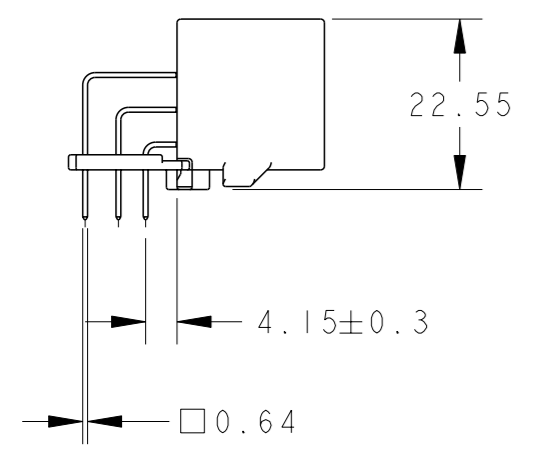
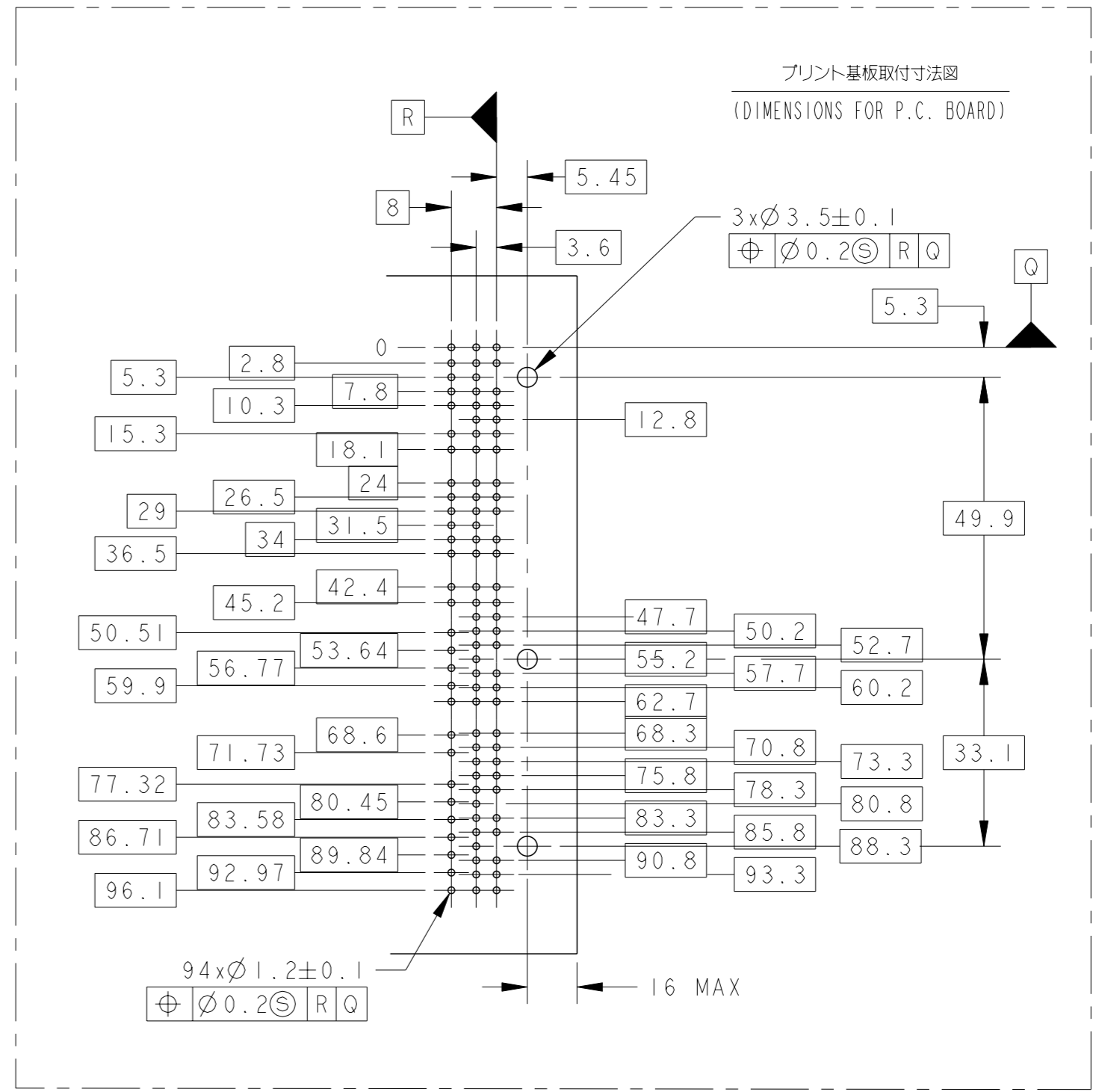
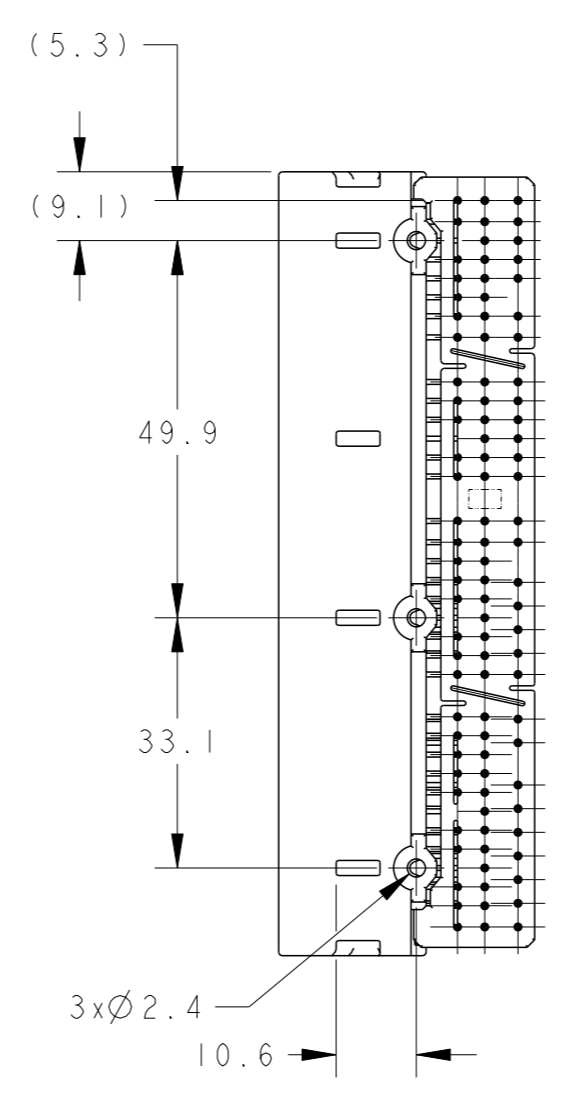
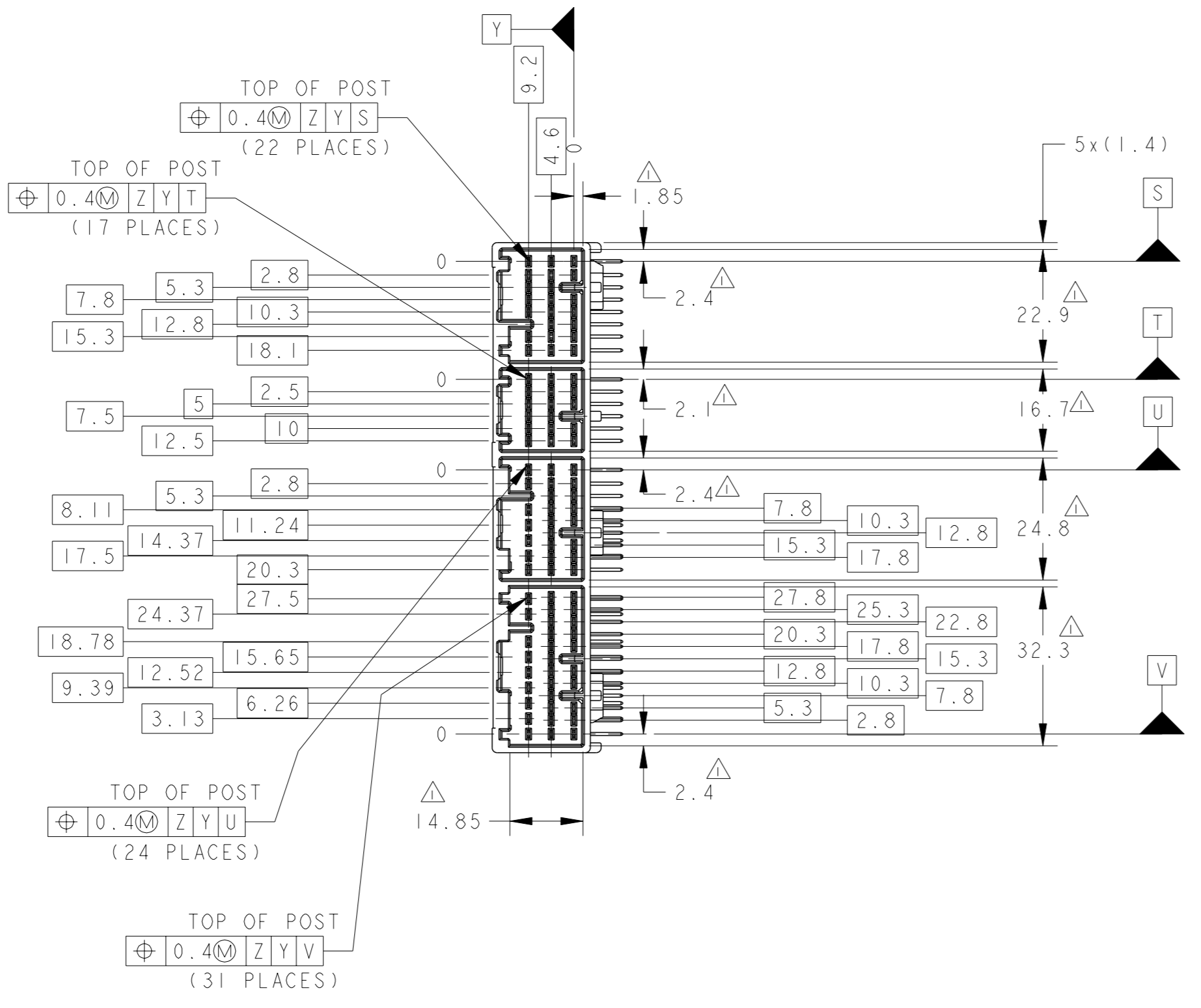
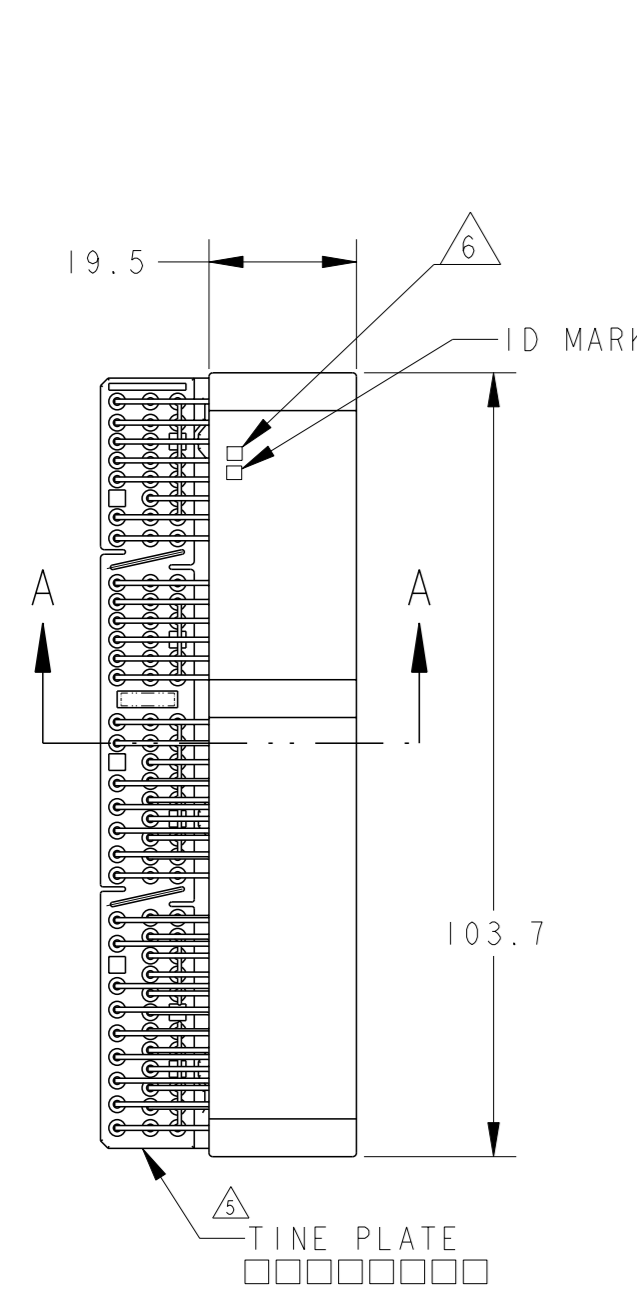
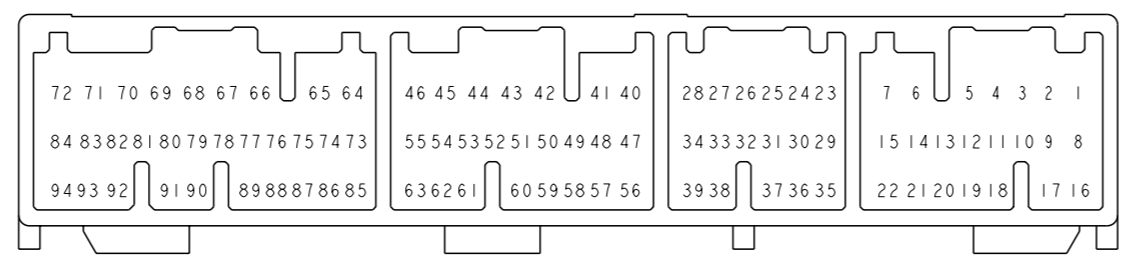

△ Fig 1 CIRCUIT NUMBER

PACKING STYLE	MARKING	SOLDERING SIDE	CONTACT SIDE	GOLD PLATED CIRCUIT NO	COLOR	PART NUMBER	
PAPER BOX ダンボール箱	PLASTIC TUBE プラスチックチューブ	1	PRE-TIN × 94	— / —	NATURAL	1123794-8	
PLASTIC BOX 通い箱	PLASTIC TUBE プラスチックチューブ	2 ₁	SELECTIVE-TIN (MATTE)	SELECTIVE GOLD × 16	12, 13, 19, 54, 55 61-63, 77, 80-83, 91-93	NATURAL	2-6123794-1
				SELECTIVE-TIN × 78 (BRIGHT)			
PAPER BOX ダンボール箱	PLASTIC TUBE プラスチックチューブ	2 ₁	SELECTIVE-TIN (MATTE)	SELECTIVE GOLD × 16	12, 13, 19, 54, 55 61-63, 77, 80-83, 91-93	NATURAL	1123794-7
				SELECTIVE-TIN × 78 (BRIGHT)			
PLASTIC BOX 通い箱	PLASTIC TUBE プラスチックチューブ	0 ₁	SELECTIVE-TIN (MATTE)	SELECTIVE-TIN × 94 (BRIGHT)	— / —	NATURAL	1123794-6
PAPER BOX ダンボール箱	PLASTIC TUBE プラスチックチューブ	3	SELECTIVE-TIN (MATTE)	SELECTIVE-TIN × 94 (BRIGHT)	— / —	NATURAL	1123794-4
PLASTIC BOX 通い箱	PLASTIC TUBE プラスチックチューブ	1	PRE-TIN × 94	— / —	NATURAL	1123794-2	
OUTER 分表	INNER 内表	MARKING △ 6	SOLDERING SIDE 半田付け部	CONTACT SIDE 接続側	GOLD PLATED CIRCUIT NO 金めっき回路番号	COLOR 色	PART NUMBER 製品型番
PACKING STYLE 梱包仕様			CONTACT FINISH コンタクト仕上				

OBSOLETE

TOLERANCE UNLESS OTHERWISE SPECIFIED.	一般公差	10± : ±0.2 30± >10 : ±0.25 100± >30 : ±0.3 ANGLE : ±3°
---------------------------------------	------	---

THIS DRAWING IS A CONTROLLED DOCUMENT.

OWNER: K. FURUYAMA 3-MAR-99
CHK: K. YUASA 3-MAR-99
APVD: K. YUASA 3-MAR-99

TE Connectivity

NAME: 040111 HIGH DENSITY CONNECTOR 94POSITION CAP HOUSING ASSEMBLY

PRODUCT SPEC: 108-5529
APPLICATION SPEC: -

SIZE: A100779 ©=1123794
CAGE CODE: -
DRAWING NO: -
RESTRICTED TO: -

WEIGHT: 35.0g
MATERIAL: PBT, BRASS
FINISH: SEE TABLE

CUSTOMER DRAWING

SCALE: 1:1 SHEET: 1 OF 1 REV: B5