

LUMAWISE Endurance S

ZHAGA BOOK 18 / Z10 STREET LIGHT CONNECTORS:

REDUCE THE COMPLEXITY OF STREET LIGHTING ARCHITECTURE

TE Connectivity (TE)'s LUMAWISE Endurance S Connector System is a complete set of products specially designed for street and area lighting. There are two main offerings. The original Endurance S Zhaga Book 18 connector system enables D4i controlled Zhaga Book 18 compliant luminaires while the Endurance S Keyed Connector System enables non-Book 18 applications like Z10.

LUMAWISE Endurance S includes a receptacle, mounted to a street or area light fixture, as well as several base and domes, that together form a robust enclosure for sensor modules and network lighting control systems. The design is compact, UV resistant, IP66 seal rated and can be mounted on the top, bottom or even the side of a luminaire, offering flexibility to the designer.

Extending from the Endurance S portfolio is the S2 receptacle. Offered in both Zhaga Book 18 and Z10 enabled keyed varieties the S2 receptacle introduces a two-wire per contact solution for ease of wiring and applied cost savings in luminaires with dual node architecture.



LUMAWISE ENDURANCE S CONNECTORS HAVE BEEN DESIGNED AS A STAND-ALONE SYSTEM AND CAN BE USED IN A COMPLEMENTARY FUNCTION AS AN AUXILIARY SENSOR MODULE WHEN ADDITIONAL FUNCTIONALITY IS REQUIRED IN ANSI/NEMA BASED LIGHTING FIXTURES. INSTALLATION IS EASY AND FAST. PUSH-AND-TWIST WITH ONE HAND LOCKING DOES NOT REQUIRE ANY SPECIAL TOOLS.

ZHAGA BOOK 18 CONNECTOR SYSTEM

FEATURES:

- Compact size allowing greater flexibility in luminaire design
- IP66 sealing with no mounting screws
- Simple insert and rotate to lock feature, no tooling needed and one handed operation to install allows luminaires to be simply and quickly upgraded
- High impact protection - IK09 rating
- Flexible mounting position. Top mounted, side mounted and bottom mounted facing
- Scalable solution allows use of Ø40mm and a Ø80mm controls with the same connection interface
- Poke-in contact design reduces logistics issues with needing different wire lengths for different luminaires
- CB certification

APPLICATIONS:

- Street and Area Lighting
- Roadway Lighting
- Commercial/Municipal Outdoor Lighting
- Outdoor Luminaires
 - Wall Packs
 - Parking Lots
 - Walkways Photo Controls
- City Management System
- Sensor modules i.e. motion

ELECTRICAL:

- Contact rating: 5A, 250V
- Meets 10kV dielectric withstand voltage to mounting surface 4 pole contacts

MECHANICAL:

- Mounting: M20X1.5 thread
- Height above luminaire: 10mm
- IP65 & IP66
- Receptacle: Ø30mm
- Gasket: Ø36.5mm
- Thread length: 18.5mm
- IK09 rated system solution

MATERIALS:

- PBT receptacle
- LSR gasket
- Polycarbonate domes
- UL UV-f1 rated for outdoor use





SPECIFICATIONS:

- Product: **108-133073**
108-160194
- Application: **114-133074**
114-160106
- Rated IEC61984 and UL773
- CB Certified

ZHAGA BOOK 18 CONNECTOR SYSTEM

Product Selection Information

	Part Number	Description	Color	Height
S2 RECEPTACLE / SEALING CAP	 2213858-1	Receptacle (includes sealing ring, washer & nut)	-	-
	 2363638-1	Receptacle S2 (includes sealing ring, washer & nut)	-	-
	1-2363638-1	Receptacle S2 w/color code (includes sealing ring, washer & nut)		
	 2213795-1 2213795-2	Sealing Cap	Dark Gray Light Gray	-

	Part Number	Description	Color	Height
40mm BASE / DOMES	 2213837-1	Base	-	-
	 2329013-1	Dome	Smoke Gray	Low (24.25mm)
	 2329013-2	Dome	Smoke Gray	Tall (39.25mm)
	 1-2329013-2	Dome	Clear	Tall (39.25mm)

Receptacles and mounting hardware available to purchase separately.



2329013-2
LUMAWISE Endurance S Dome
Smoke Gray - Tall - 40mm

2213837-1
LUMAWISE Endurance S Base
40mm

2363638-1
LUMAWISE Endurance S2
Receptacle

Receptacle S2

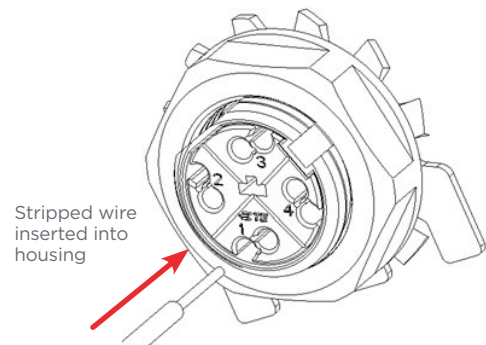

Stripped wire
inserted into
housing

Wire poke-in locations (4)

Pin #	Function
1	+24V power supply
2	Negative pole for Dali or Dali based protocol & shared ground return for 24V power supply
3	Positive pole for Dali or Dali based protocol
4	General digital I/O (greater than 7V)

LUMAWISE Endurance S products represented on this page are not shown actual size.

ZHAGA BOOK 18 CONNECTOR SYSTEM



Product Selection Information

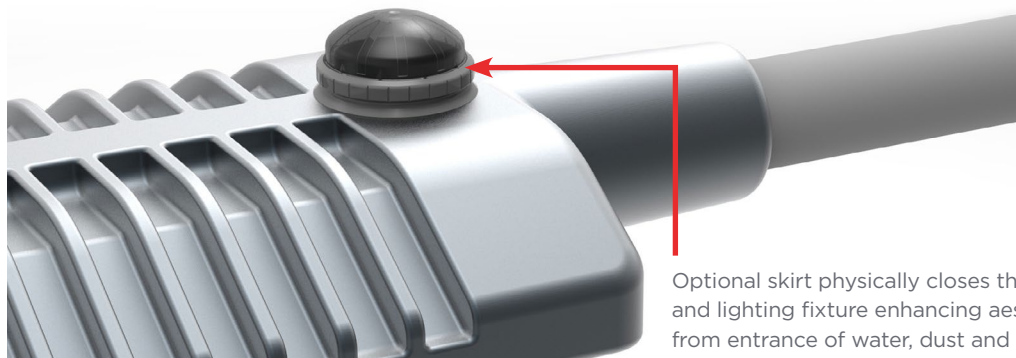

	Part Number	Description	Color	Height
80mm BASES / DOMES	 2213831-3	Base	-	-
	 2213831-2	Base with Vent	-	-
	 2328823-1	Dome	Smoke Gray	Low (33.43mm)
	 1-2328823-1	Dome	Clear	Low (33.43mm)
	 2328823-2	Dome	Smoke Gray	Medium (43.43mm)
	 1-2328823-2	Dome	Clear	Medium (43.43mm)
	 2328823-3	Dome	Smoke Gray	Tall (58.43mm)
	 1-2328823-3	Dome	Clear	Tall (58.43mm)
OPTIONAL ACCESSORIES	 1-2337216-1	Skirt	Black	-
	 1-2337216-2	Skirt	Light Gray	-
	 1-2337216-3	Skirt	Dark Gray	-





Optional skirt physically closes the gap between control module and lighting fixture enhancing aesthetics and further protecting from entrance of water, dust and insects.

Z10 ENABLED CONNECTOR SYSTEM

	Part Number	Description	Color	Key
RECEPTACLE / SEALING CAP	 2343403-1	S Receptacle (includes sealing ring, washer & nut)	Black	A
	 2363638-2	S2 Receptacle (dual wire poke-in includes sealing ring, washer & nut)	Black	A
	 1-2363638-2	S2 Receptacle w/color code (dual wire poke-in includes sealing ring, washer & nut)	Black	A
	 2341474-1 2341474-2 2341474-3	Sealing Cap	Dark Gray Light Gray White	A

	Part Number	Description	Key
40mm / 80mm BASES	 2343405-1	40mm Base	A
	 2-2343404-1	80mm Base	A
	 1-2343404-1	80mm Base with vent	A

	Part Number	Description	Color	Height
40mm DOMES	 1-2329013-1	40mm Dome	Clear	Low (24.25mm)
	 1-2329013-2	40mm Dome	Clear	Tall (39.25mm)
80mm DOMES	 1-2328823-1	80mm Dome	Clear	Low (33.43mm)
	 1-2328823-2	80mm Dome	Clear	Medium (43.43mm)
	 1-2328823-3	80mm Dome	Clear	Tall (58.43mm)

FEATURES (S2 Receptacle PN 2363638)

- Receptacle connector with double poke-in wire entry
- Strong wire-trap poke-in retention
- Wire release feature
- Light colored wire entry surface
- Directional washer
- Compression stop on sealing gasket

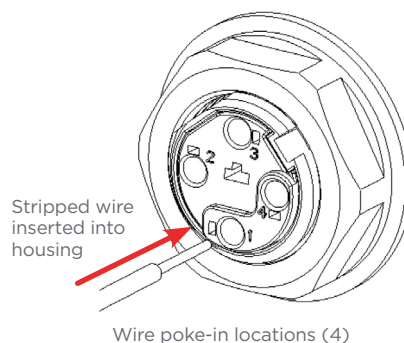
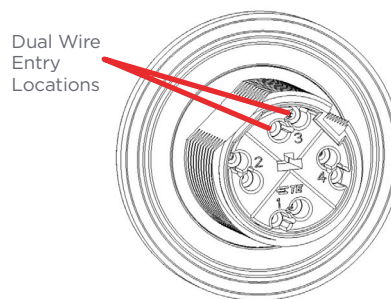

RECOMMENDED PIN OUT FOR 0-10V DIMMING CONTROL APPLICATION

Pin #	Function
1	DC+
2	0-10V DIM-DC
3	0-10V DIM+
4	OPTIONAL

Colored wire insertion markings and additional keying solutions are also available, contact [Product and Customer Support](#).

CONNECTOR SYSTEM

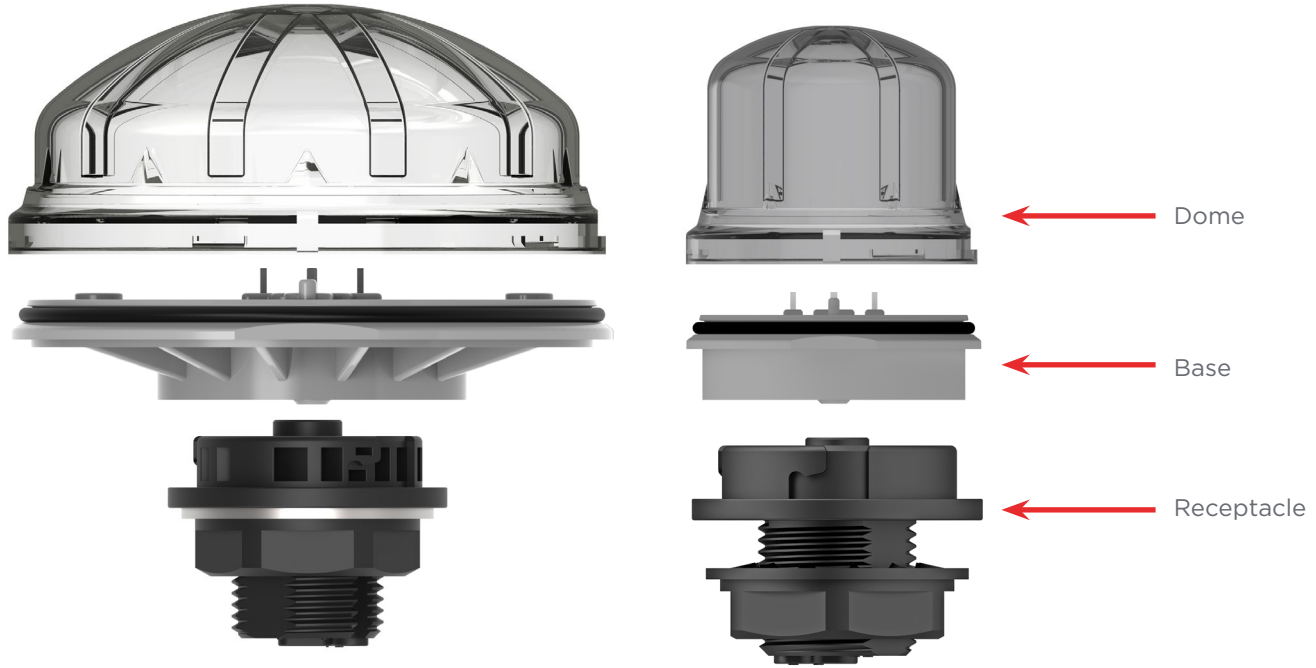

1-2343404-1
LUMAWISE Endurance S Base with Vent
Key A 80mm

Flat surface for label placement.

An optional vent in the 80mm base assembly enables pressure optimization inside the sealed control module. The vent also helps to minimize condensation through vapor diffusion.

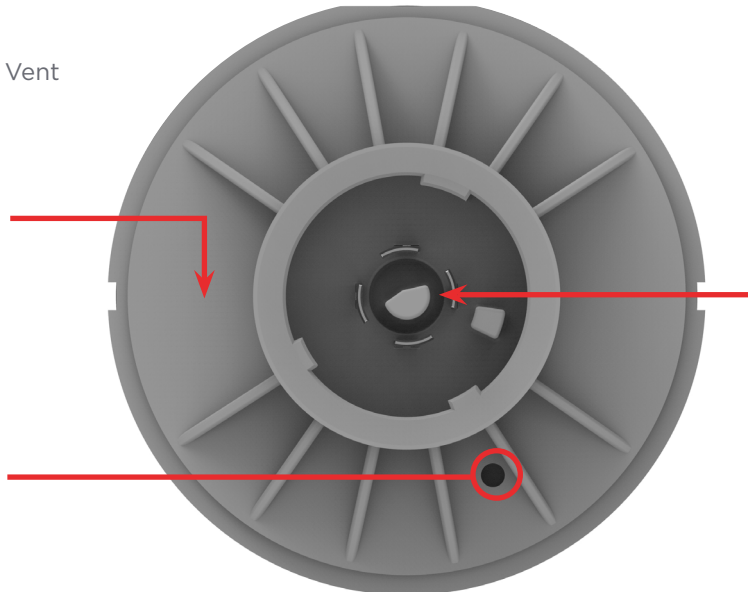

Keying feature of base aligns with equivalent Keying feature on Receptacle for protected mating.

LUMAWISE Endurance S products represented on this page are shown actual size.



TE Connectivity is a participating member of the Zhaga Consortium, an industry-wide cooperation enabling the interchangeability of LED light sources and simplifying LED applications for general lighting.

te.com

© 2021 TE Connectivity. All Rights Reserved.

LUMAWISE, TE Connectivity, TE connectivity (logo) and Every Connection Counts are trademarks. All other logos, products and/or company names referred to herein might be trademarks of their respective owners.

While TE has made every reasonable effort to ensure the accuracy of the information in this brochure, TE does not guarantee that it is error-free, nor does TE make any other representation, warranty or guarantee that the information is accurate, correct, reliable or current. TE reserves the right to make any adjustments to the information contained herein at any time without notice. TE expressly disclaims all implied warranties regarding the information contained herein, including, but not limited to, any implied warranties of merchantability or fitness for a particular purpose. The dimensions in this catalog are for reference purposes only and are subject to change without notice. Specifications are subject to change without notice. Consult TE for the latest dimensions and design specifications.

05/21