

ENTRELEC

Electrical Solutions



INSULATED WIRE END FERRULES

Crimp Technology

Connection capacity: from 0.34 mm² to 50 mm² - 22 to 1 AWG

The ENTRELEC ferrules provide an easy, clean and reliable connection of flexible and stranded wires. They are adapted to screw, push-in and spring connections and used worldwide in many industrial or commercial applications where contact precision is key.



SPEED UP YOUR PROJECTS

- Facilitate wire insertion into terminal clamps of terminal blocks or other control devices
- Save installation time by using the push-in technology of the ENTRELEC SNK Terminal blocks with flexible wires
- Funneled entry for fast and splice-free cable insertion.



SECURED INSTALLATION

- High level crimp performance with TE tooling
- Conductor protection from breakage due to bending, stress or vibrations
- Multiple re-wiring allowed without damaging the cable performances.



FOR ALL YOUR NEEDS

- cULus and cCSAus certifications for all products*
- 
- DIN and French color coding on the plastic sleeves
 - 105°C Max Operating Temperature.

*Except WF003-08-GN with cULus only.



INSULATED WIRE END FERRULES

SINGLE WIRE END FERRULES

DIN 46228/4 COLOR CODE

From 0.34 mm² to 50 mm² - 22 to 1 AWG

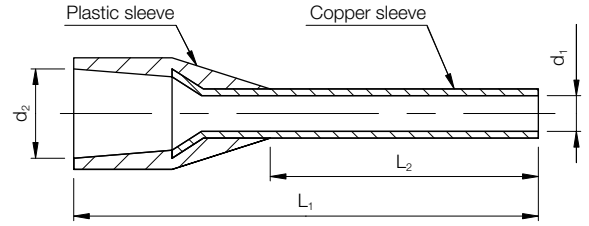

Wire size		Color	Type	Part Number	Dimensions (mm)				Packing	
mm ²	AWG				L1	L2	d1	d2	Bag	Shipping Box
0.34	22	Turquoise	WF003-08-TR	1SET111026R0000	12.0	8.0	0.8	2.0	500	5000
0.50	20	White	WF005-08-WH	1SET111002R0000	14.0	8.0	1.0	2.6	500	5000
0.75	18	Grey	WF007-08-GR	1SET111027R0000	14.0	8.0	1.2	2.8	500	5000
			WF007-12-GR	1SET111028R0000	18.0	12.0	1.2	2.8	500	5000
1	17	Red	WF010-08-RD	1SET111005R0000	14.0	8.0	1.4	3.0	500	5000
			WF010-12-RD	1SET111006R0000	18.0	12.0	1.4	3.0	500	5000
1.5	16	Black	WF015-08-BK	1SET111007R0000	14.0	8.0	1.7	3.5	500	5000
			WF015-12-BK	1SET111008R0000	18.0	12.0	1.7	3.5	500	5000
			WF015-18-BK	1SET111009R0000	24.0	18.0	1.7	3.5	500	5000
2.5	14	Blue	WF025-08-BL	1SET111029R0000	14.0	8.0	2.2	4.2	500	5000
			WF025-12-BL	1SET111030R0000	18.0	12.0	2.2	4.2	500	5000
			WF025-18-BL	1SET111031R0000	24.0	18.0	2.2	4.2	500	5000
4	12	Grey	WF040-10-GR	1SET111032R0000	17.0	10.0	2.8	4.8	500	3000
			WF040-12-GR	1SET111033R0000	20.0	12.0	2.8	4.8	500	3000
			WF040-18-GR	1SET111034R0000	26.0	18.0	2.8	4.8	500	3000
6	10	Yellow	WF060-12-YL	1SET111035R0000	20.0	12.0	3.5	6.3	100	1000
			WF060-18-YL	1SET111036R0000	26.0	18.0	3.5	6.3	100	1000
10	8	Red	WF100-12-RD	1SET111037R0000	22.0	12.0	4.5	7.6	100	1000
			WF100-18-RD	1SET111038R0000	28.0	18.0	4.5	7.6	100	1000
16	6	Blue	WF160-12-BL	1SET111039R0000	24.0	12.0	5.8	8.8	100	1000
			WF160-18-BL	1SET111040R0000	28.0	18.0	5.8	8.8	100	1000
25	4	Black	WF250-16-BK	1SET111022R0000	30.0	16.0	7.3	11.2	50	500
			WF250-22-BK	1SET111023R0000	36.0	22.0	7.3	11.2	50	500
35	2	Red	WF350-16-RD	1SET111024R0000	30.0	16.0	8.3	12.7	50	500
50	1	Blue	WF500-20-BL	1SET111025R0000	36.0	20.0	10.3	15.0	50	500

TWIN WIRE END FERRULES

DIN 46228/4 COLOR CODE

From 0.5 mm² to 6 mm² - 20 to 10 AWG

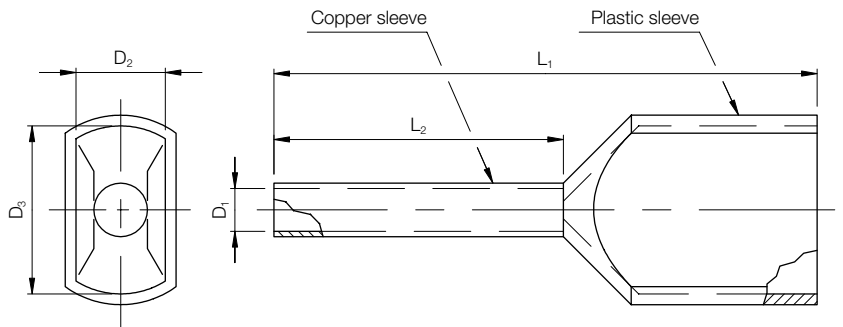

Wire size		Color	Type	Part Number	Dimensions (mm)					Packing	
mm ²	AWG				L1	L2	D1	D2	D3	Bag	Shipping Box
2 x 0.5	2 x 20	White	WFD005-08-WH	1SET112001R0000	15.0	8.0	1.4	2.5	4.7	500	5000
2 x 0.75	2 x 18	Grey	WFD007-08-GR	1SET112011R0000	15.0	8.0	1.7	2.8	5.0	500	5000
			WFD007-10-GR	1SET112012R0000	17.0	10.0	1.7	2.8	5.0	500	5000
2 x 1	2 x 17	Red	WFD010-08-RD	1SET112004R0000	15.0	8.0	2.0	3.4	5.4	500	5000
2 x 1.5	2 x 16	Black	WFD015-08-BK	1SET112005R0000	16.0	8.0	2.2	3.6	6.6	500	5000
			WFD015-12-BK	1SET112006R0000	20.0	12.0	2.2	3.6	6.6	500	5000
2 x 2.5	2 x 14	Blue	WFD025-10-BL	1SET112013R0000	18.5	10.0	2.8	4.2	7.8	500	3000
			WFD025-13-BL	1SET112014R0000	21.5	13.0	2.8	4.2	7.8	500	3000
2 x 4	2 x 12	Grey	WFD040-12-GR	1SET112015R0000	23.0	12.0	3.7	4.9	8.8	100	1000
2 x 6	2 x 10	Yellow	WFD060-14-YL	1SET112016R0000	26.0	14.0	4.8	6.9	10.0	100	1000



INSULATED WIRE END FERRULES

SINGLE WIRE END FERRULES

NFC 63023 COLOR CODE

From 0.34 mm² to 50 mm² - 22 to 1 AWG

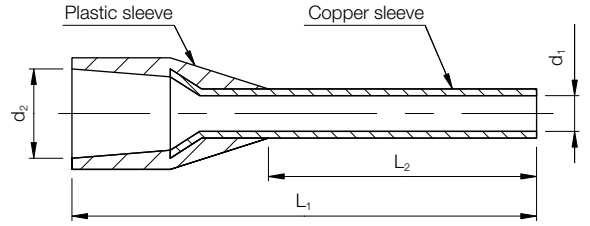

Wire size		Color	Type	Part Number	Dimensions (mm)				Packing	
mm ²	AWG				L1	L2	d1	d2	Bag	Shipping Box
0.34	22	Green	WF003-08-GN	1SET111001R0000	12.0	8.0	0.8	2.0	500	5000
0.50	20	White	WF005-08-WH	1SET111002R0000	14.0	8.0	1.0	2.6	500	5000
0.75	18	Blue	WF007-08-BL	1SET111003R0000	14.0	8.0	1.2	2.8	500	5000
			WF007-12-BL	1SET111004R0000	18.0	12.0	1.2	2.8	500	5000
1	17	Red	WF010-08-RD	1SET111005R0000	14.0	8.0	1.4	3.0	500	5000
			WF010-12-RD	1SET111006R0000	18.0	12.0	1.4	3.0	500	5000
1.5	16	Black	WF015-08-BK	1SET111007R0000	14.0	8.0	1.7	3.5	500	5000
			WF015-12-BK	1SET111008R0000	18.0	12.0	1.7	3.5	500	5000
			WF015-18-BK	1SET111009R0000	24.0	18.0	1.7	3.5	500	5000
2.5	14	Grey	WF025-08-GR	1SET111010R0000	14.0	8.0	2.2	4.2	500	5000
			WF025-12-GR	1SET111011R0000	18.0	12.0	2.2	4.2	500	5000
			WF025-18-GR	1SET111012R0000	24.0	18.0	2.2	4.2	500	5000
4	12	Orange	WF040-10-OR	1SET111013R0000	17.0	10.0	2.8	4.8	500	3000
			WF040-12-OR	1SET111014R0000	20.0	12.0	2.8	4.8	500	3000
			WF040-18-OR	1SET111015R0000	26.0	18.0	2.8	4.8	500	3000
6	10	Green	WF060-12-GN	1SET111016R0000	20.0	12.0	3.5	6.3	100	1000
			WF060-18-GN	1SET111017R0000	26.0	18.0	3.5	6.3	100	1000
10	8	Brown	WF100-12-BR	1SET111018R0000	22.0	12.0	4.5	7.6	100	1000
			WF100-18-BR	1SET111019R0000	28.0	18.0	4.5	7.6	100	1000
16	6	Ivory	WF160-12-IV	1SET111020R0000	24.0	12.0	5.8	8.8	100	1000
			WF160-18-IV	1SET111021R0000	28.0	18.0	5.8	8.8	100	1000
25	4	Black	WF250-16-BK	1SET111022R0000	30.0	16.0	7.3	11.2	50	500
			WF250-22-BK	1SET111023R0000	36.0	22.0	7.3	11.2	50	500
35	2	Red	WF350-16-RD	1SET111024R0000	30.0	16.0	8.3	12.7	50	500
50	1	Blue	WF500-20-BL	1SET111025R0000	36.0	20.0	10.3	15.0	50	500

TWIN WIRE END FERRULES

NFC 63023 COLOR CODE

From 0.5 mm² to 6 mm² - 20 to 10 AWG

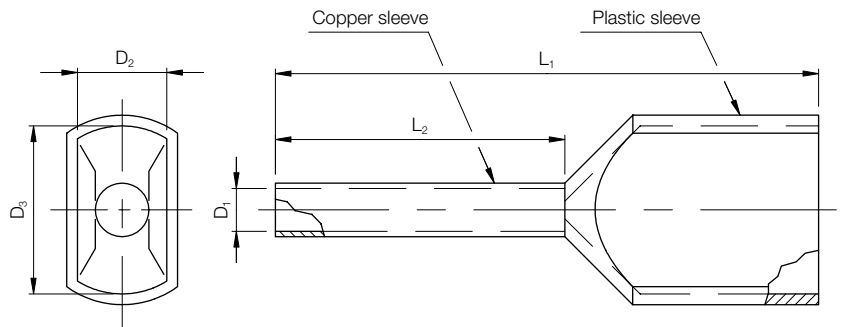

Wire size		Color	Type	Part Number	Dimensions (mm)					Packing	
mm ²	AWG				L1	L2	D1	D2	D3	Bag	Shipping Box
2 x 0.5	2 x 20	White	WFD005-08-WH	1SET112001R0000	15.0	8.0	1.4	2.5	4.7	500	5000
2 x 0.75	2 x 18	Blue	WFD007-08-BL	1SET112002R0000	15.0	8.0	1.7	2.8	5.0	500	5000
			WFD007-10-BL	1SET112003R0000	17.0	10.0	1.7	2.8	5.0	500	5000
2 x 1	2 x 17	Red	WFD010-08-RD	1SET112004R0000	15.0	8.0	2.0	3.4	5.4	500	5000
2 x 1.5	2 x 16	Black	WFD015-08-BK	1SET112005R0000	16.0	8.0	2.2	3.6	6.6	500	5000
			WFD015-12-BK	1SET112006R0000	20.0	12.0	2.2	3.6	6.6	500	5000
2 x 2.5	2 x 14	Grey	WFD025-10-GR	1SET112007R0000	18.5	10.0	2.8	4.2	7.8	500	3000
			WFD025-13-GR	1SET112008R0000	21.5	13.0	2.8	4.2	7.8	500	3000
2 x 4	2 x 12	Orange	WFD040-12-OR	1SET112009R0000	23.0	12.0	3.7	4.9	8.8	100	1000
2 x 6	2 x 10	Green	WFD060-14-GN	1SET112010R0000	26.0	14.0	4.8	6.9	10.0	100	1000

MANUAL HAND TOOLING

The tools below are compatible for all the ferrules mentioned in this brochure (with respect to their maximum wire capacity).

To crimp wire end ferrule above 16 mm² (6 AWG) and keep the UL and CSA certification, please use the crimping tool from alternative manufacturer: Klauke K28 ⁽¹⁾.

(1) This tool is not available at TE. Please contact your local distributor.

Side entry tool

Part Nbr.: 1SET191003R0000



- For 0.08 up to 10 mm² (28 to 8 AWG) wire crimping
- Square crimp profile with 4 serrated crimp surfaces
- Certified for UL and CSA Applications.

Front entry tool

Part Nbr.: 1SET191004R0000



- For 0.08 up to 16 mm² (28 to 6 AWG) wire crimping
- Pre-selection of crimping wire ranges by a change over switch
- Releasable ratchet
- Square crimp profile with 4 serrated crimp surfaces
- Certified for UL and CSA applications.

te.com

ENTRELEC, TE Connectivity, TE Connectivity (logo) and Every Connection Counts are trademarks. All other logos, products and/or company names referred to herein might be trademarks of their respective owners.

All other logos, products and/or company names referred to herein might be trademarks of their respective owners.

The information given herein, including drawings, illustrations and schematics which are intended for illustration purposes only, is believed to be reliable. However, TE Connectivity makes no warranties as to its accuracy or completeness and disclaims any liability in connection with its use. TE Connectivity's obligations shall only be as set forth in TE Connectivity's Standard Terms and Conditions of Sale for this product and in no case will TE Connectivity be liable for any incidental, indirect or consequential damages arising out of the sale, resale, use or misuse of the product. Users of TE Connectivity products should make their own evaluation to determine the suitability of each such product for the specific application.

© 2021 TE Connectivity Ltd. family of companies All Rights Reserved.

5-1773985-1 12/21

TE Connectivity

3, rue Jean Perrin
69687 Chassieu cedex
France

Tel: +33 481923100

www.te.com/