

Introduction

Product Facts

- No need for inhibitor agents, thanks to our “dry crimp” technique
- Terminating/splicing capabilities for stranded aluminum wire, plus splicing of aluminum wire to copper wire conductors
- Wide wire-size range — aluminum 8 to 4/0 [8.6 to 110.9 mm²] and copper 10 to 3/0 [4.8 to 85.9 mm²]
- Efficient production rates, uniform reliability, at low cost — all because of AMP electro-hydraulic DYNA-CRIMP Tooling
- Optimum electrical, environmental, and mechanical performance crimps from AMP three-stage dies
- Portable battery powered hydraulic unit is available and low pressure crimp dies for 2/0 size

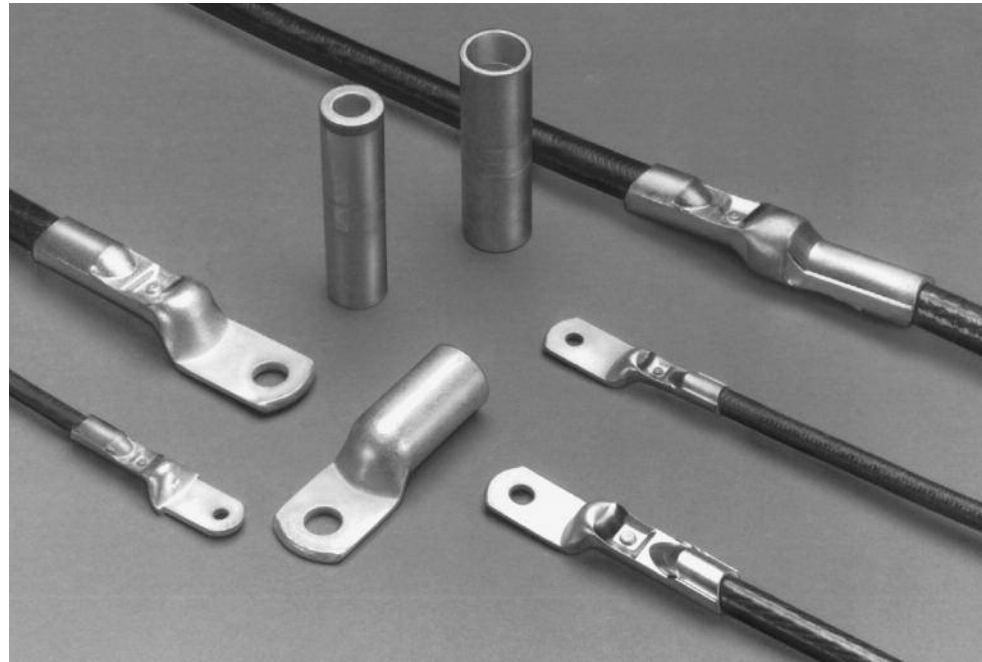

AMP COPALUM Sealed Terminals and Splices are designed especially for solving the inherent problems of terminating aluminum conductors. These connectors are terminated to stranded aluminum wire using a “dry crimp.” This technique eliminates the need for an inhibitor agent to break down the highly tenacious and inert oxides that form on aluminum conductors. An extremely efficient and reliable crimping method, the dry crimp also produces a sealed connection that better prevents re-oxidation and corrosion when intimate terminal/conductor contact is achieved.

AMP COPALUM Sealed Terminals and Splices are available for terminating and splicing stranded aluminum wire in sizes ranging from 8 to 4/0 [8.6 to 110.9 mm²] and copper 10 to 3/0 [4.8 to 85.9 mm²]. With the capability of splicing aluminum wire to copper wire, these connectors are generally applicable wherever aluminum wire or cable is

used. AMP COPALUM Sealed Terminals and Splices are especially suited for the aerospace industry.

Each connector body is constructed of tin-plated copper and houses a nickel-plated brass insert and funnel. The funnel is designed to better prevent wire strands from hanging up when inserted into the wire barrel. The perforated insert enhances reliability for the terminal and splice when crimped to the aluminum/copper conductors.

During the crimping operation, the relatively soft conductor material extrudes through the insert holes, causing the brittle oxide to be sheared, and clean conductor metal to be brought into intimate contact with the inner surfaces of the body and insert. These areas of extrusion form an air- and moisture-tight seal, minimizing oxidation and corrosion.

Stranded-wire crimping also produces “cold welding” or solid-phase bonding

between each wire strand. During the crimping process, deformation pressure is applied from several planes, causing sufficient plastic flow of the conductor material. This fractures the oxide film on each wire strand and induces different rates of extrusion. The resulting wiping action under pressure produces interstrand bonding, yielding many contact surfaces and a substantial increase in the contact area. Excellent electrical characteristics are thus achieved.

The increase in contact area also decreases the chances of electrical malfunction due to creep, differences in thermal expansion, and corrosion. Also the insert grips the conductor securely, providing a good mechanical connection.

Economical termination of these connectors becomes a reality with the use of the AMP electro-hydraulic DYNA-CRIMP Tool. This tool is equipped with a uniquely designed die that simultaneously produces three distinct crimps.

Technical Documents

Instruction Sheets

- 408-2281 — Application Terminals and Splices Tooling
- 408-2453 — Tool 69066/Crimping Die
- 408-9535 — Tool 58422-1

Product Specifications

- 108-11011 — Overall Aluminum Wires
- 108-11011-1 — Copper Wires
- 108-11011-2 — High Temp. Wires with Flag Terminals

Application Specifications

- 114-2134

10

Terminals and Splices

Introduction (Continued)

Product Evolution

The AMP Sealed COPALUM terminal and splice product line was established in the 1950's. Originally it had two separate product lines, one for aluminum wire and one for copper wire. Each line had butt connectors and terminals.

The Aluminum wire connector bodies were made of stamped and formed aluminum strip stock and COPALUM terminal connector bodies were made of stamped and formed copper strip stock.

Both products contained a closed cup (cartridge) installed within each wire barrel. This cartridge contained an oxide inhibiting compound with abrasive particles that flowed during crimping into the strand voids (interstices) and mechanically abraded the wire and barrel oxide surfaces. The oxide inhibitor protected the contact surfaces from further oxidation and formed a temporary partial seal between the conductor and the crimped insulation support.

The crimp dies were the two stage type and of the confined crescent design. The first stage crimped the wire barrel and cartridge, while the second stage crimped only the flared cartridge end. This second stage crimp produced the insulation support which was designed as a strain relief.

In the 60's, all copper bodies and perforated inserts were introduced. The industry wanted a dry crimp with a fully sealed body. Some important advantages of the copper design are:

1. Almost all buss contacts are copper. The plated terminal tongue needs no special contact surface treatment against the bolted copper buss. This is the (dynamic), disconnectable part of the connection.
2. The copper wire barrel allows for a natural two step down capacity from an equivalent aluminum wire to copper wire.
Example—#4 aluminum down to #6 copper.
3. The more dense copper has 100% electrical conductivity compared to aluminum at 61% maximum. Copper compared to aluminum has hardly any mechanical creep; therefore, with the proper crimp, it provides a much more stable crimped (static), permanently sealed connection.
4. Within the circuit design there is always a need to change from high temperature copper wires to lower temperature aluminum wires. With the copper connector, we have the choices of "optional" (4 AL-6 CU) or "primary" (4 AL-4 AL) or "secondary" (6 CU-6CU) all within the same wire barrel and crimp die envelope.
5. During crimping, the hard nickel plated perforated insert digs into and intimately connects the wire and copper body while at the same time increasing the fresh surface contact areas via the holes and extrusion. With this feature, we now have a preferred "dry" connection with the copper to aluminum transition occurring inside the connector body where it is protected and controlled.
6. The barrier walls of the terminal and splice body provide the blind hole required for an environmentally-sealed crimp.
7. The product has a three stage simultaneous crimp design which allows for a very secure electrical crimp, a smooth transition crimp which goes up to the full round sealing crimp. It also has an identification feature and maintains maximum connector wall thickness after crimp.

We made several changes to the product line in the 80's and also changed the part numbers as listed below.

1. The perforated insert was modified without causing a change in connector performance.
2. The internal components were oriented and permanently locked in place during manufacture.
3. Clearer, more permanent marking was introduced with the straight knurl stripes replacing the blue ink stripe guides used to show crimp location.

TE Connectivity continually monitors incoming material for material conformance. Consolidation of production facilities and improved equipment produce more accurate component parts which, after heat treatment and plating, yield an overall higher quality assembly. All customer drawings are now on new formats and are on CAD. Catalog and instructional materials are regularly updated.

In April 1993, a new application sheet 114-2134 was completed. Also in 1993, we released a whole line of two stud hole terminals, silver plated with high temperature terminals, two 4/0 AL style terminals, a new crimp die, and various sheared tongue styles.

Using engineering tools like CAE/CAD/CAM, thermography, and computer driven image analysis on crimp cross-sections, we are able to arrive at and maintain optimum product integrity and reliability.

As with all AMP products, we have a continuing program of product and process improvements to promote maximum performance to meet customer's needs.

Single Hole Ring Tongue Terminals

Standard Tongue

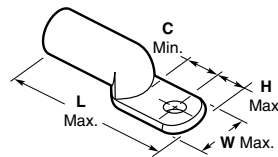

Sheared Tongue

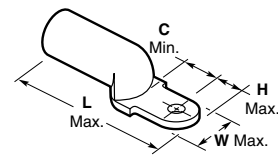

Wire Size Circular Mils mm ²		Insul. Dia. Range	Tongue Thickness (Nom.)	Stud Size	Tongue Type	Dimensions				Part Number	Weight Grams*	Tooling for Power Unit 1804700-1 or -2						
Aluminum	Copper					H Max.	L Max.	W Max.	C Min.			Heads	Die					
8 16564 8.6	10 9354 4.8	.182-.200 4.62-5.08	.069 1.75	10	—	.291 7.39	1.66 42.16	.592 15.04	.50 12.70	277147-1	11.0	1752877-1 or 1752787-1	68006					
				1/4 6.35						277147-3	—							
				3/8 9.52						277147-2	10.0							
				10						Sheared	.250 6.35			1.63 41.40	.492 12.50	.54 13.72	277147-5	10.3
6 28280 14.6	8 16983 8.8	.225-.250 5.72-6.35	.088 2.24	10	—	.310 7.88	1.90 48.26	.627 15.92	.47 11.94	277148-1	16.8	1752877-1 or 1752787-1	68007					
				1/4 6.35						277148-2	16.6							
				5/16 7.92						277148-3	16.2							
				3/8 9.52						277148-4	15.3							
4 42420 21.9	6 26818 13.8	.276-.305 7.01-7.75	.082 2.08	10	—	.310 7.88	2.00 50.8	.627 15.92	.53 13.46	277154-1	15.2	1752877-1 or 1752787-1	68008					
				1/4 6.35						277148-7	15.0							
				3/8 9.52						277149-5	—							
				1/4 6.35						Sheared	.310 7.88			2.00 50.8	.627 15.92	.53 13.46	277149-2	19.4
2 67872 35.0	4 42615 22.0	.340-.380 8.64-9.65	.093 2.36	1/4 6.35	—	.335 8.51	2.37 60.20	.675 17.15	.54 13.72	277149-3	18.9	1752877-1 or 1752787-1	68009					
				3/8 9.52						277150-1	36.0							
				1/4 6.35						Sheared	.250 6.35			2.30 58.42	.492 12.50	.60 15.24	277150-3	34.0
				1/4 6.35						277155-1	33.5							
1/0 107464 55.5	2 66500 34.3	.425-.470 10.79-11.94	.101 2.57	1/4 6.35	Short	.401 10.19	2.51 63.75	.812 20.62	.49 12.45	277151-3	—	1752877-1 or 1752787-1	68010-1					
				3/8 9.52						277151-1	53.3							
				5/16 7.92						277151-7	—							
				1/4 6.35						Long	.448 11.38			2.73 69.34	.812 20.62	.72 18.29	277151-5	57.0
2/0 138168 71.3	1/0 104500 53.9	.500-.550 12.7-13.97	.128 3.25	1/4 6.35	Short	.451 11.46	2.81 71.37	.911 23.14	.51 12.95	277152-1	—	1752877-1 or 1752787-1	314964-1 or 68011-1					
				3/8 9.52						277152-2	76.3							
				5/16 7.92						277152-3	80.0							
				3/8 9.52						Long	.451 11.46			3.05 77.47	.911 23.14	.75 19.05	277152-4	81.0
3/0 168872 87.2	2/0 133000 68.6	.520-.645 13.21-16.38	.132 3.35	1/2 12.7	Long (Narrow)	.430 10.93	3.05 77.47	.850 21.59	.75 19.05	277152-5	78.0	1752877-1 or 1752787-1	59877-1					
				3/8 9.52						55944-1	81.0							
4/0 214928 110.94	3/0 166500 85.94	.590-.680 14.99-17.27	.177 4.50	3/8 9.52	—	.440 11.18	3.21 81.53	1.00 25.4	.73 18.54	277153-1	103.0	1752787-1	59877-1					
				1/2 12.7						55995-1 (55995-2) 184113-1	100 98.0							

*Aluminum 8 to 2 = ±3 grams; aluminum 1/0 to 3/0 = ±5 grams

Double Hole Ring Tongue Terminals

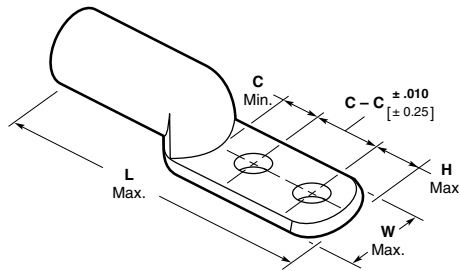

Wire Size Circular Mills mm ²		Insul. Dia. Range	Tongue Thickness (Nom.)	Stud Size	Tongue Type	Dimensions				Part Number	Weight Grams*	Tooling for Power Unit 1804700-1 or -2	
Aluminum	Copper					H Max.	L Max.	W Max.	C - C			C Min.	Heads
6 28280 14.6	8 16983 8.8	.225-.250 5.72-6.35	.088 2.24	1/4 6.35 3/8 9.52	Two Hole	.38 9.65	2.89 73.41	.63 16.00	1.00 25.4	.44 11.18	55832-1 24 55832-2 23	1752877-1 or 1752787-1	68007
4 42420 21.9	6 26818 13.8	.276-.305 7.01-7.75	.082 2.08	1/4 6.35 3/8 9.52	Two Hole	.38 9.65	2.94 74.68	.63 16.00	1.00 25.4	.44 11.18	55833-1 (55834-1) 26 55833-2 (55834-2) 25	1752877-1 or 1752787-1	68008
2 67872 35.0	4 42615 22.0	.340-.380 8.64-9.65	.093 2.36	1/4 6.35 3/8 9.52	Two Hole	.38 9.65	3.27 83.06	.68 17.27	1.00 25.4	.44 11.18	55835-1 (55836-1) 44 55835-2 (55836-2) 43	1752877-1 or 1752787-1	68009
1/0 107464 55.5	2 66500 34.3	.425-.470 10.79-11.94	.101 2.57	3/8 9.52	Two Hole	.38 9.65	3.39 86.11	.81 20.57	1.00 25.4	.44 11.18	55837-1 (55838-1) 62	1752877-1 or 1752787-1	68010-1
2/0 138168 71.3	1/0 104500 53.9	.500-.550 12.7-13.97	.128 3.25	3/8 9.52	Two Hole	.38 9.65	3.66 92.96	.91 23.11	1.00 25.4	.44 11.18	55839-1 (55844-1) 91	1752877-1 or 1752787-1	314964-1 or 68011-1
3/0 168872 87.2	2/0 133000 68.6	.520-.645 13.21-16.38	.132 3.35	3/8 9.52	Two Hole	.38 9.65	3.82 97.03	1.00 25.4	1.00 25.4	.44 11.18	55840-1 113	1752787-1	59877-1
4/0 214928 110.94	3/0 166500 85.94	.590-.680 14.99-17.27	.177 4.50	3/8 9.52	Two Hole	.38 9.65	3.72 94.49	1.00 25.4	1.00 25.4	.44 11.18	(55841-1) 113	1752787-1	314948-1

Note: Part numbers with () are silver plated, part numbers without are tin plated.
* Aluminum 8 to 2 = ±3 grams; aluminum 1/0 to 4/0 = ±5 grams.

Flag Terminals

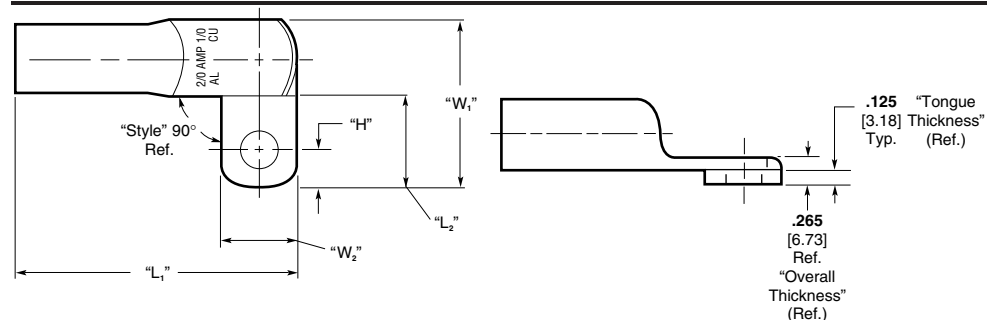

Wire Size Circular Mills mm ²		Insul. Dia. Range	Tongue Thickness (Ref.)	Stud Size	Tongue Style	Dimensions				Part Number	Weight Grams*	Tooling for Power Unit 1804700-1 or -2	
Aluminum	Copper					H Max.	L ₂ Max.	L ₂ Min.	W ₁ Max.			W ₂ Max.	Heads
2/0 138168 71.3	1/0 104500 53.9	.500-.550 12.7-13.97	.125 3.18	3/8 9.52	One Hole 90° Right Hand	.43 10.9	3.185 80.90	.970 24.64	1.870 47.50	.850 21.59	55982-1 109	1752877-1 or 1752787-1	314964-1 or 68011-1

* Aluminum 8 to 2 = ±3 grams; aluminum 1/0 to 4/0 = ±5 grams.

Standard Butt Splices

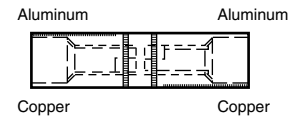
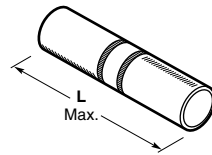

Wire Size* Circular Mils mm ²		Insul. Dia. Range	L Max.	Part Number	Weight Grams**	Tooling for Power Unit 1804700-1 or -2	
Aluminum	Copper					Heads	Die
8 16564 8.6	10 9354 4.8	.182-.200 4.62-5.08	1.41 35.81	277156-1	10.2	1752877-1 or 1752787-1	68006
6 28280 14.6	8 16983 8.8	.225-.250 5.72-6.35	1.80 45.72	277157-1	16.9	1752877-1 or 1752787-1	68007
4 42420 21.9	6 26818 13.8	.276-.305 7.01-7.75	2.17 55.12	277158-1	26.8	1752877-1 or 1752787-1	68008
2 67872 35.0	4 42615 22.0	.340-.380 8.64-9.65	2.54 64.52	277159-1	50.3	1752877-1 or 1752787-1	68009
1/0 107464 55.5	2 66500 34.3	.425-.470 10.79-11.94	2.67 67.82	277160-1	76.0	1752877-1 or 1752787-1	68010-1
2/0 138168 71.3	1/0 104500 53.9	.500-.550 12.70-13.97	3.01 76.45	277161-1	107.7	1752877-1 or 1752787-1	68011-1 or 314964-1
3/0 168872 87.2	2/0 133000 68.6	.520-.645 13.21-16.38	3.26 82.80	277162-1	127.5	1752787-1	59877-1

* For aluminum-to-aluminum applications, splices will accept the same wire size at either end. For aluminum-to-copper applications, however, the size of the copper wire must be "stepped down" two wire sizes to compensate for differences in the electrical ratings of copper and aluminum.

** Aluminum 8 to 2 = ±3 grams; aluminum 1/0 to 3/0 = ±5 grams

Transitional Butt Splices

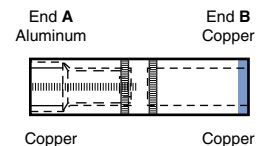
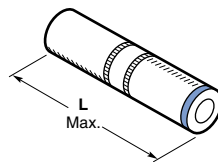

Wire Size Circular Mils mm ²		Insul. Dia. Range		L Max.	Part Numbers	Weight Grams*	Tooling for Power Unit 1804700-1 or -2	
End A	End B	End A	End B				Heads	Die
6 28280 14.6	6 26818 13.8	.225-.250 5.72-6.35	.225-.250 5.72-6.35	1.80 45.72	55984-1**	16	1752877-1 or 1752787-1	68007
4 42420 21.9	8 16983 8.8	.276-.305 7.01-7.75	.210-.255 5.33-6.48	1.91 48.51	277164-1	26.5	1752877-1 or 1752787-1	68008
4 42420 21.9	4 42615 22.0	.276-.305 7.01-7.75	.276-.305 7.01-7.75	2.17 55.12	277165-1**	26.0	1752877-1 or 1752787-1	68008
1/0 107464 55.5	4 42615 22.0	.425-.470 10.80-11.94	.276-.305 7.01-7.75	2.70 68.58	277163-1	92.5	1752877-1 or 1752787-1	68010-1
3/0 168872 87.2	1/0 104500 53.9	.520-.645 13.21-16.38	.430-.495 10.92-12.57	3.26 82.80	277168-1	128.5	1752787-1	59877-1

* ± 10 grams

** Transitional splice test amperage is for aluminum wire.

Application Tooling

The AMP COPALUM Sealed Terminals and Splices are designed to be terminated with precision die sets, crimping heads, and hydraulic power units. The die set to use will depend on the conductor material size to be terminated. Both crimping heads can be used for the smaller conductor sizes. The largest conductor sizes will require the use of the heavier head. Hydraulic power can be provided by either the Electric/Hydraulic Power Unit or the Hydraulic Foot Pump.



**Crimping Head
1752787-1
(408-8914)**



**Crimping Head
1752877-1
(408-8956)**



**Typical Die Set
(408-2281)**

DYNA-CRIMP Electric-Hydraulic Power Unit

The DYNA-CRIMP Power Unit is an electric hydraulic tool. It can accommodate various heads and dies for terminating AMP terminals and splices ranging in size from 8 to 1500 MCM. A complete accessory line is also available with the tool for use in portable and stationary applications as well as for multiple-head crimping.



**DYNA-CRIMP Electric-Hydraulic Power Unit
(Includes Pressure Release)
115 Volts (60 Hz) — 1804700-1
230 Volts (50/60 Hz) — 1804700-2
(409-10081)**



**Hydraulic Hand Pump
1583661-1**



**Hydraulic Foot Pump
1583659-1**

Use with Hose Assembly 1583662-[]

Wire Size AWG		Crimp Tool Components		
Aluminum	Copper	Die Sets	Heads	Power Units
8	10	68006		
6	8	68007		
4	6	68008		
2	4	68009		
1/0	2	68010-1	1752877-1* or 1752787-1**	1804700-1 1804700-2 or 1583659-1
2/0	1/0	68011-1		
		314964-1		
3/0	2/0	59877-1		
4/0	3/0	314948-1		

*For aluminum conductor range of 8 through 1/0 and copper conductor range of 10 through 2.
**For aluminum conductor range of 8 through 4/0 and copper conductor range of 10 through 3/0.
***Portable—low pressure crimp die.

Accessory Power Controls and Hoses For DYNA-CRIMP Electric-Hydraulic Power Unit

Consult the table to the right for accessory power controls and hoses. Control and hose accessories must be ordered separately.

If electric hydraulic tool is to be used in portable applications, a handle control and hose assembly should be used.

For stationary applications, a foot switch assembly and hose assembly will be necessary.

Multidirectional valves are used when more than one crimping head is permanently attached to the tool.

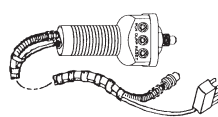

Handle Control



Hose Assembly

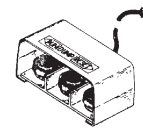

Foot Control

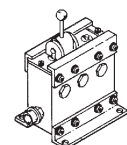

Multidirectional Valve

For use with Power Unit No.	Accessory Description	Accessory Part Number	Remarks
1804700-1 1804700-2	7 ft. [2.13 m] Handle Control Assembly — Hose and Cord	1901775-1	Pressure Release included with handle control
	15 ft. [4.57 m] Handle Control Assembly — Hose and Cord	1901776-1	
	21 ft. [6.4 m] Handle Control Assembly — Hose and Cord	1901777-1	
	15 ft. [4.57 m] Foot Switch Assembly	68284-1	Needs Hose Assembly
	6 ft. [1.83 m] Hose Assembly	1583662-1	68284-1 Foot Switch or Foot Pump Assembly needed with these Hose Assemblies
	10 ft. [3.05 m] Hose Assembly	1583662-2	
	20 ft. [6.10 m] Hose Assembly	1583662-3	
1804700-1	3-Way Multi-Directional Valve	1901782-1	For use with
1804700-2	3-Way Multi-Directional Valve (Elec. Control)	1901783-1	Foot Switch only

www.tooling.tycoelectronics.com
www.tooling.tycoelectronics.com/europe