



**Electronics**

Tyco Electronics Corporation  
300 Constitutional Drive  
Menlo Park, CA 94025 USA  
DCR: D020282

**Raychem**

No.: **RPIP-696-00**  
Rev: F  
Date: September 5, 2002  
Pages: 1 of 9

**HET-A-02X, HET-A-04X AND HET-A-05X  
FOR HEXASHIELD™ ADAPTERS**

- 1 - Introduction
- 2 - Applicable Documents
- 3 - Application Equipment And Materials.
- 4 - Cable Accommodation And Preparation.
- 5 - Assembly.
- 6 - Termination Procedure.
- 7 - Inspection.
- 8 - Repair.
- 9 - HET Removal

All information, including illustrations, is believed to be reliable. Users, however, should independently evaluate the suitability of each product for their application. Tyco Electronics Corporation makes no warranties as to the accuracy or completeness of the information and disclaims any liability regarding its use. Tyco Electronics' only obligations are those in the Tyco Electronics Standard Terms and Conditions of Sale or this product, and in no case will Tyco Electronics be liable for any incidental, indirect, or consequential damages arising from the sale, use, or misuse of the product. Specifications are subject to change without notice. In addition, Tyco Electronics reserves the right to make changes—without notification to the buyer—to materials or processing that do not affect compliance with any applicable specification.

## 1. Introduction

This document describes the installation and repair procedures for HET-A-02X, HET-A-04X and HET-A-05X cable shield termination devices. These products are designed for use with Tyco Electronics / Raychem Hexashield™ connector adapters.

Each HET-A-02X, HET-A-04X or HET-A-05X or part consists of one plated metal ferrule, one SolderShield® heat-shrinkable solder device and one short piece of heat shrinkable tubing.

One to four cable shields are connected to a ferrule by the SolderShield® device. The primary wires are installed in the connector, and the cable and ferrule assemblies are then installed in the Hexashield™ adapter. Refer to the appropriate Hexashield™ adapter installation procedure for final assembly.

## 2. Applicable Documents

RPIP-696-01 Hexashield™ Adapter Installation Procedure, ARINC 600 Size II  
RPIP-696-02 Hexashield™ Adapter Installation Procedure, ARINC 600 Size III  
RPIP-696-04 Hexashield™ for Cylindrical Connectors, Installation Procedure, Straight Body  
RPIP-696-07 Hexashield™ for Cylindrical Connectors, Installation Procedure, Right Angle Body  
HET-A-02X Specification Control Drawing  
HET-A-04X Specification Control Drawing  
HET-A-05X Specification Control Drawing

## 3. Application Equipment and Materials:

- Equivalent tools may be used.

- 3.1 AD-1319-9 Holding fixture  
ECE-0188 Ferrule support fixture

- 3.2 Recommended Hot air tools:  
-Raychem CV-1981 with PR-25D reflector, temperature control set to 7.5 / 8.5 with the vent open (420°C±20°C).

-Steinel HL 1802 E with PR-25D reflector and PR adapter, or Steinel 5/8" reflector, temperature control set to 11 / 12, high fan speed.

- 3.3 Solid, uninsulated, tin-plated copper wire, ø0.2 to 0.4mm (ø.008 to .016in).  
Optional. To secure and maintain shield alignment during installation. See section 5.2.

**4. Cable Accommodation and Preparation:**

**4.1 Cable type.**

-Single or multi-conductor shielded cables, having a 125°C minimum temperature rating, with single round or flat tin, silver or nickel-plated braids.

**4.2** Number of shielded cables per ferrule: 4 maximum. (See sections 4.3 and 4.5)

**4.3** Cable accommodation dimensions. Use the tables below to choose the correct size HET.  
 Note: For HET-A-05X, see Specification Control Drawing.

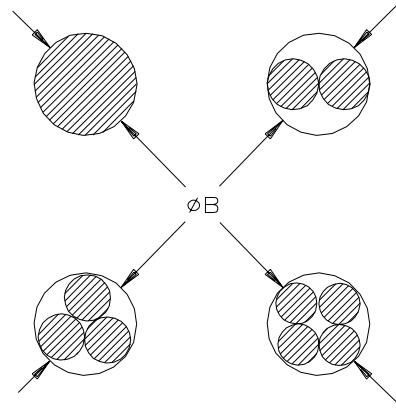
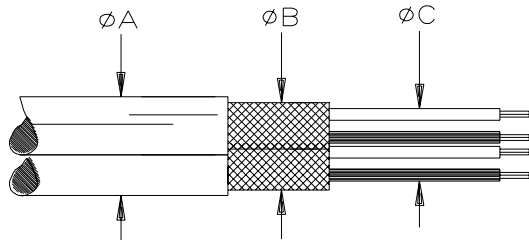

**HET-A-02X**

Envelope Diameters for HET-A-02X				
øA		øB		øC
Min.	Max.	Min.	Max.	Max.
3.1	6.9	2.4	5.3	4.2
(.122)	(.271)	(.094)	(.208)	(.165)

**HET-A-04X**

Envelope Diameters for HET-A-04X				
øA		øB		øC
Min.	Max.	Min.	Max.	Max.
4.3	8.9	2.4	6.2	4.2
(.170)	(.350)	(.094)	(.244)	(.165)

Unless otherwise specified, dimensions are in millimeters.  
 Inches dimensions are in between brackets.

4.4 Strip the cables to the dimensions below and to the tables that follow:

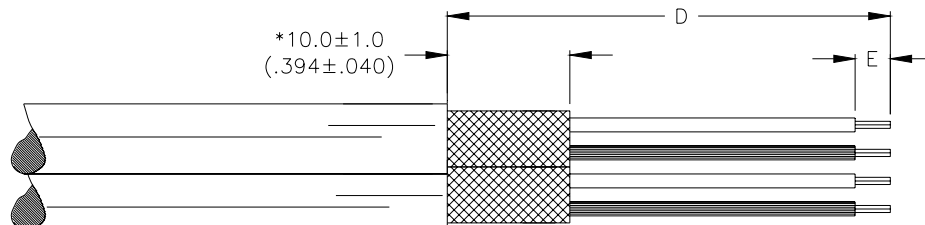

\*For HET-A-05, use  $15.0 \pm 1.0$  (.590 ± .040)

E dimension: Refer to the crimp contact manufacturer's instructions.

D dimension: Allows for a minimum of one repair of the crimp contacts.

Hexashield™ Adapter  
with Straight Body

Hexashield Code	*D ±1.0 (D ±.040)
ARINC 600	82.0 (3.250)
Code 40	78.0 (3.100)
Code 41	78.0 (3.100)
Code 54	78.0 (3.100)

Hexashield™ Adapter  
with 45° or 90° Body

Hexashield Size	*D ±1.0 (D ±.040) Codes 40,41,54
09	80.0 (3.150)
11/13	90.0 (3.550)
15/17	100.0 (3.950)
19	105.0 (4.130)
21	115.0 (4.530)
23	120.0 (4.720)
25	125.0 (4.920)

\*For HET-A-05, use D +10.0 (+.395)

Unless otherwise specified, dimensions are in millimeters.  
Inches dimensions are in between brackets.

4.5 User Specific Applications.

To facilitate adapter assembly, alternate strip lengths may be used. For very stiff or heavy primary wire insulations, dimension D may be slightly adjusted, as required. Be sure to leave enough primary wire length to fit the contact insertion / extraction tool. Any variations to the wire preparation dimensions must be approved by the users Engineering department.

The maximum number of shielded cables per ferrule specified for this product is 4. If an application uses more than 4 shielded cables per ferrule, it is the responsibility of the end user to evaluate and determine the suitability of such configurations in that application.

**5. Assembly:**

- 5.1 Install the ferrule support ECE-0188 on to the holding fixture AD-1319-9. Adjust the distance between the ferrule support and the cable clamp. Align the V shaped groove in the ferrule support with the V groove in the cable clamp. Tighten the Allen head screws to secure the support and clamp to the holding fixture. (Fig 1, page 6)
- 5.2 Optional. If four shielded cables are used in one ferrule, tie them together as shown, using tin plated copper wire. Trim ends to 5 mm (.200 in) long and fold flat along length of cable.

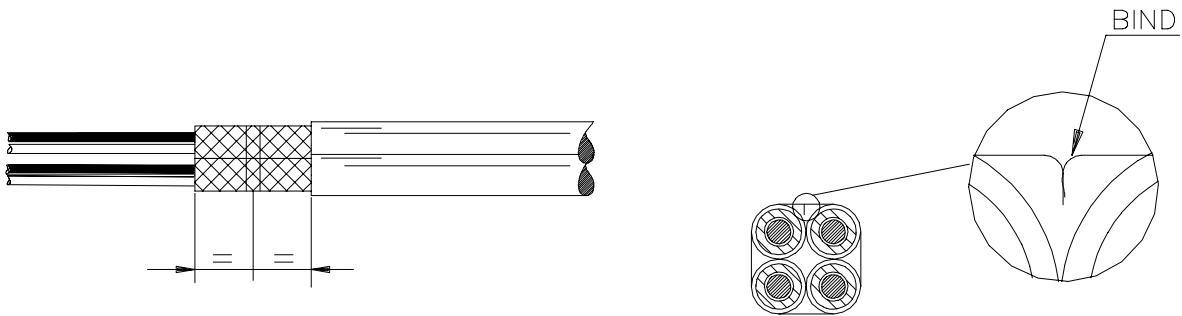

- 5.3 Slide the short piece of heat shrinkable tubing provided with the HET over the primary wires until the tubing butts against the cable braid(s). This tubing must be used with all primary wires less than 1.0 mm (.039 in) diameter to prevent small gauge wires from being damaged by the ferrule slot. The tubing also secures and aligns multiple cables during termination, and its use is recommended for all primaries. Heat the tubing to shrink in place.
- 5.4 Slide the SolderShield® device and the ferrule over the cable as shown.

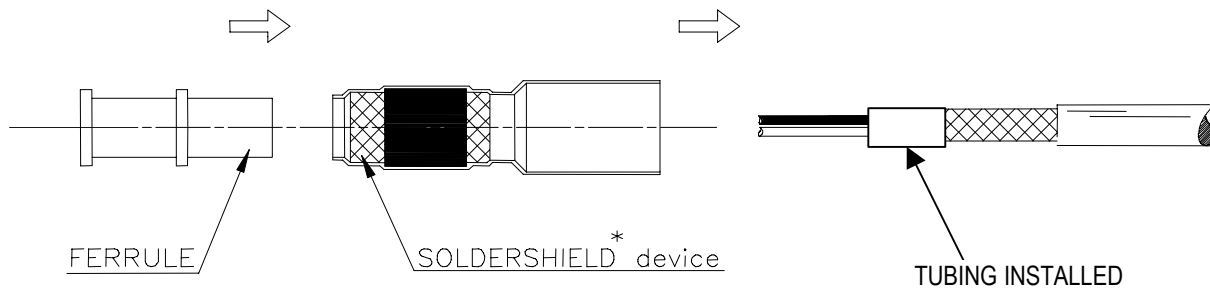

- 5.5 Position the assembly in the holding fixture according to the dimensions shown in Fig. 1 below. The ferrule is correctly positioned in the V groove of the ECE-0188 adapter when the two larger diameter flanges of the ferrule rest on either side of the adapter V groove.

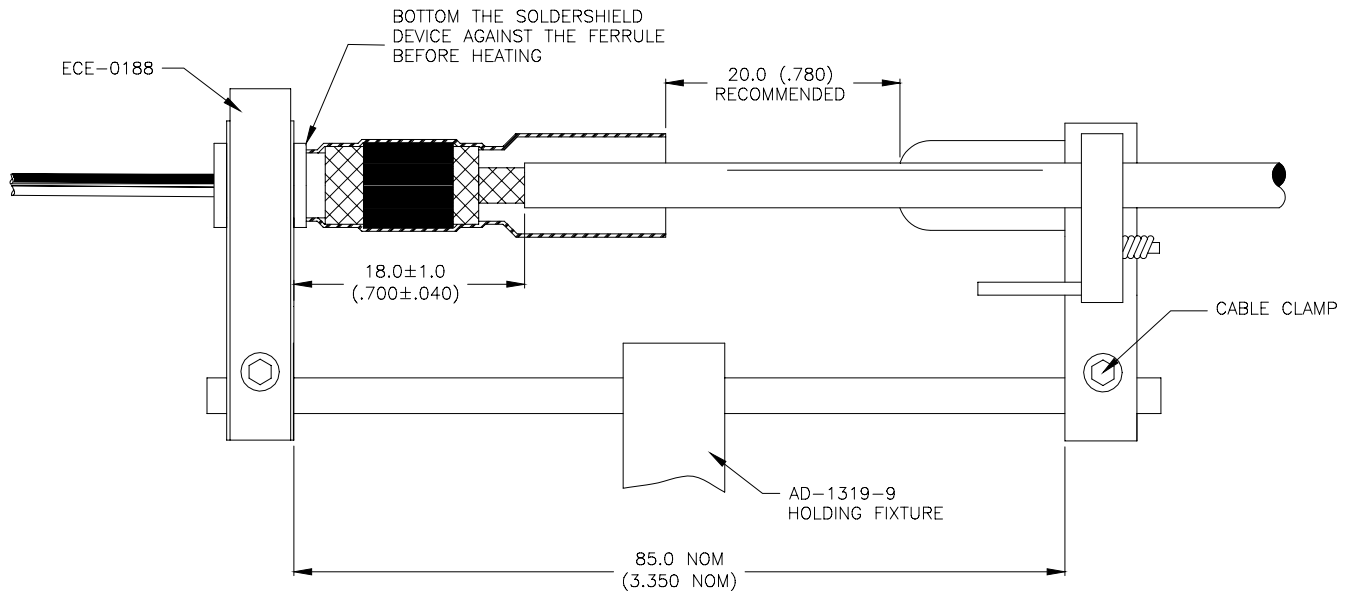
**Fig. 1**

Unless otherwise specified, dimensions are in millimeters.  
Inches dimensions are in between brackets.

## 6. Termination Procedure:

- 6.1 Allow the hot air tool to warm up for at least 1 minute to its operating temperature before heating the assembly.
- 6.2 Position the solder preform in the center of the reflector.
- 6.3 Heat until the solder preforms are completely melted and solder fillets are formed between the ferrule and SolderShield® device, and between the cable braids and SolderShield® device. If necessary, continue to heat the device, moving towards the cable until the tubing is fully shrunk on to the cable jacket(s).

### **WARNING**

The heating tool and the assembly become hot during the installation of the SolderShield device. To prevent burns, allow tool and the assembly to cool down before handling.

- 6.4 Allow the assembly to cool before removing it from the holding fixture.

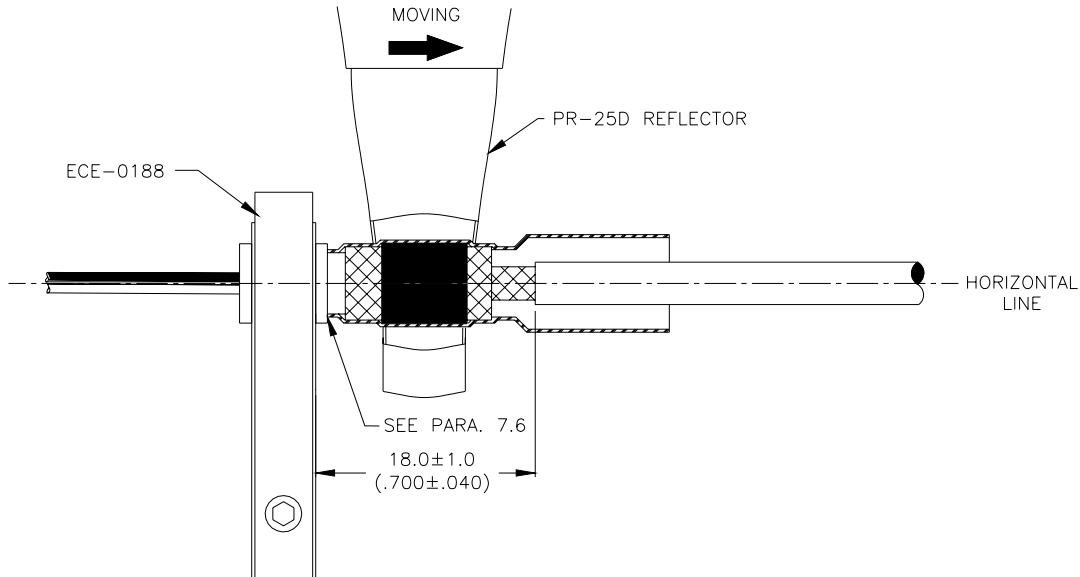
**7. Inspection:**

- 7.1 The  $18.0 \pm 1.0$  mm ( $.700 \pm .040$  in.) dimension must be maintained.
- 7.2 The SolderShield® device braid must not overlap or touch the cable jacket.
- 7.3 The solder preform must have completely melted, and flowed along the braid(s).
- 7.4 Visible remnants of the original shape of the solder preform indicate an underheated termination.
- 7.5 A highly discolored dark brown sleeve indicates an overheated termination. Slight browning of the sleeve is acceptable.
- 7.6 The gap between the end of the sleeve and shoulder of the ferrule must not exceed 1.3 mm (.050 in.)
- 7.7 Inspection for damage
- The insulating sleeve must not be cut or split.
  - There must be no braid strands poking through the sleeve.
  - The insulation sleeve and cable jacket(s) must not show signs of mechanical damage or overheating such as cuts, melting or charring.

**8. Repair:****8.1 Repair of underheated termination:**

Reheat underheated termination to obtain proper solder flow and /or fully recovered sleeve onto the cable jacket.

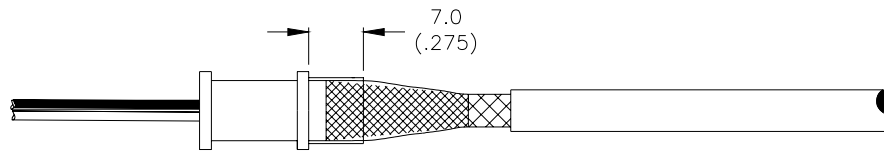
**8.2 Repair of overheated or damaged termination: See HET removal operation on section 9.****9. HET Removal:****9.1 For SPEC 55® wire and similar constructions, where the insulating sleeve is not bonded to the cable jacket, remove the ferrule and SolderShield® device as follows:**

- Score the insulation sleeve circumferentially, approximately 7.0 mm (.275 in) from the lip of the ferrule. Score the insulation sleeve lengthwise and remove the insulation sleeve. Heat may be used to assist in sleeve removal. Be careful not to cut the cable jacket.
- Grip the ferrule with pliers. Heat the SolderShield® device to cable braid solder joint until the solder melts, then remove the ferrule and SolderShield® device by pulling it straight off the cable with the pliers. If the ferrule and braid do not come off together, thoroughly heat the braid and gently pull it off the cable. The solder must be fully melted or the cable braid may be damaged, particularly flat braids.
- If it is necessary to separate multiple cables that were used through a single ferrule, remove the shrinkable tubing over the primaries, if present. Heat the braids until the solder melts. Separate the cable shields by gently pulling them apart.

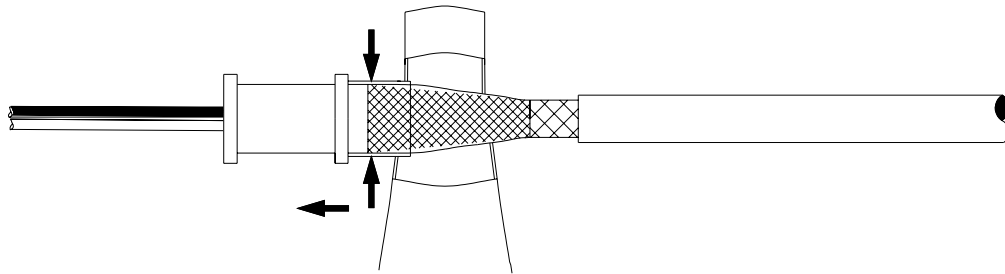

- If necessary, re-strip the cable(s) in accordance with section 4.
- Install a new ferrule and SolderShield® device in accordance with section 5 and 6.



- 9.2 For SPEC 44 ® wire and similar constructions, where the cable jacket and the insulation Sleeve are bonded together, remove the ferrule and SolderShield® device as follows:

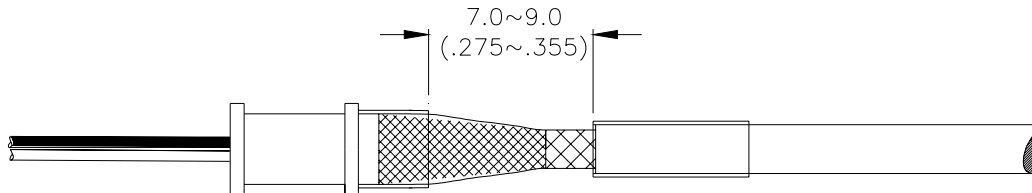

- Score the insulation sleeve circumferentially in two places as shown. The scoring on cable side should be approximately even with the end of the cable jacket.
- Score the tubing lengthwise and remove the 7 to 9 mm (.275 to .355 in) section of insulation sleeve. Be careful not to cut the cable jacket. Heat may be used to assist in sleeve removal.
- A remnant of insulation sleeve will remain on the cable jacket and does not affect installation of a new ferrule and SolderShield® device.
- Remove the ferrule and SolderShield® device by following the procedure described in section 9.1
- Install a new ferrule and SolderShield® device in accordance with sections 5 and 6. If necessary, re-strip the cable in accordance with section 4.

INSULATION SLEEVE REMNANT DOES NOT AFFECT A NEW INSTALLATION

