

CONTENTS

1 GLOBAL OVERVIEW.....	5
2 MEASUREMENT PROCESS	6
3 DATA PROCESS	6
3.1 Data processing.....	6
3.2 Trig measurement command.....	6
3.3 Datalog data	6
3.4 Live mode	7
3.5 Threshold event manager.....	7
3.6 Bluetooth® Communication	9
3.6.1 Bluetooth® Connected Mode.....	9
3.6.2 Access to Connected mode	9
3.6.3 Exiting from Connected mode.....	9
3.6.4 Device Firmware Update (DFU Mode) :.....	10
3.6.5 List of services available	10
3.7 PAYLOAD description	11
3.7.1 Keep Alive.....	11
3.7.2 Bluetooth® Generic Advertising message format	11
3.7.3 Global overview of payload available depending on communication	12
3.7.4 Device status	13
3.7.5 Device Type.....	14
3.7.6 Diagnosis	14
3.7.7 Battery	16
3.7.8 Bluetooth®.....	16
3.7.9 Internal platform temperature.....	18
3.7.10 Data Collection.....	18
3.7.11 Live mode	20
3.7.12 Threshold.....	21
3.7.13 Datalog	25
4 BATTERY.....	27

4.1 Saft LS17330.....27

4.2 Battery life.....27

6.2 BATTERY REPLACEMENT28

5 MAGNETIC SWITCH29

6 LED30

7 DIMENSIONS31

8 MOUNTING CONSIDERATIONS32

9 CERTIFICATIONS & COMPLIANCES33

10 REGULATORY STATEMENTS33

11 EU CONFORMITY35

12 ORDERING INFORMATION36

1 GLOBAL OVERVIEW

The Pressure sensor operates as a smart device. It offers sensor acquisition, processing capabilities, analysis, and wireless communication capabilities.

The sensor computes pressure data in a smart way:

- Delta detection
- Raw data

Data is sent via BLE advertising. The sensor may be configured via the BLE connection, which also gives users access to other features like live data and datalog.

The threshold can be configured. User must choose between data options to feed threshold.

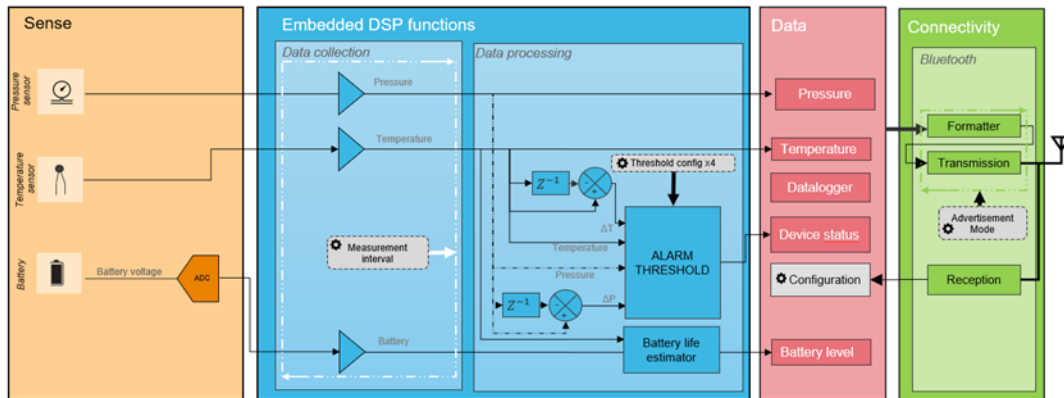

!The temperature provided is used for internal processing and should not be used as accurate temperature data!

2 MEASUREMENT PROCESS

The platform acquires digital data from the sensor:

- The system acquires and stores data.
- The system applies sensitivity to the raw value.

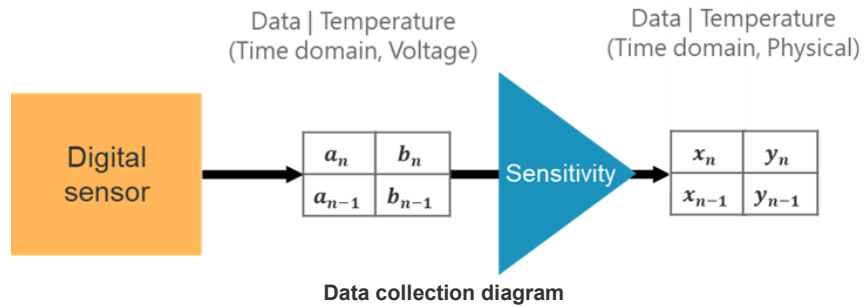

At every measurement interval, the platform powers up the sensor and requests a new acquisition, then the sensor provides pressure and temperature data. Both data types are stored. When the measurement interval is changed, a new measurement is performed, and the new value is received by the system.

3 DATA PROCESS

3.1 Data processing

Time domain data is used to calculate a variation between two data types.

$$\Delta(n) = x_n - x_{n-1}$$

3.2 Trig measurement command

The user can request a new measurement without waiting for the measurement interval. After a trigger measurement command, measurement will occur after the next interval.

3.3 Datalog data

The system stores in 4096 data points in memory. When the memory is full FIFO is used to manage data storage.

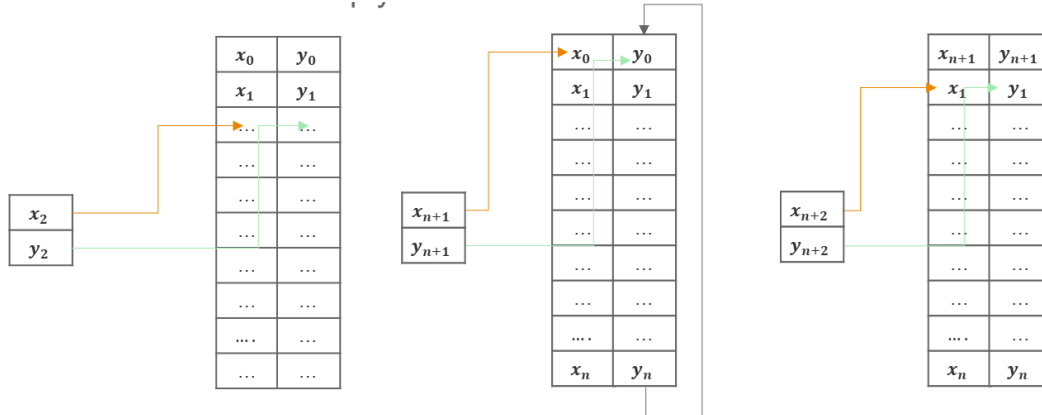

Data stored in memory is available in BLE connected mode.

The last data stored in memory will have index 0.

System can provide information about data acquired: min, max, mean, standard deviation.

3.4 Live mode

When connected mode is activated, the user can get access to live mode. It will acquire data at a new measurement interval fixed at 100ms and provide all data in “real time”.

When the user ends the BLE connection, the system returns to its current configuration and applies the defined measurement interval.

Note: If a threshold is reached during live mode the system will use the threshold measurement interval. Otherwise, it will use a standard measurement interval.

3.5 Threshold event manager

Threshold event manager allows users to have a defined configuration when a value reaches a specified level (main sensor and/or secondary sensor).

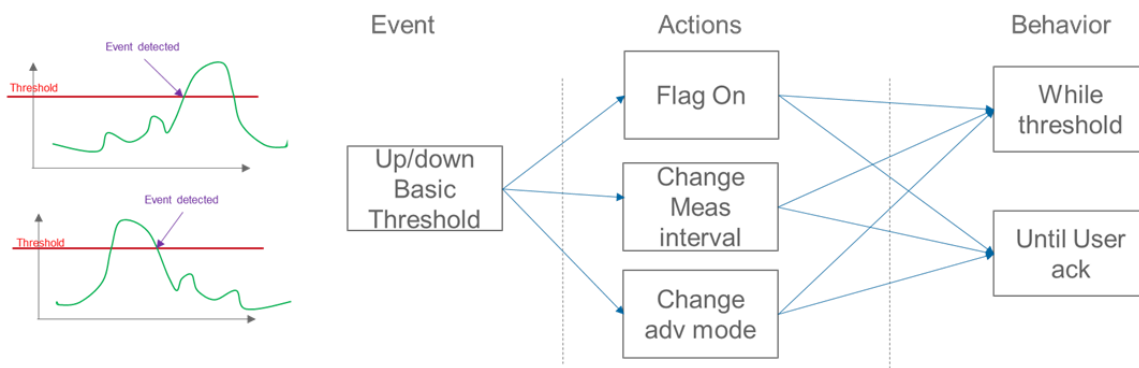

- Greater than/Less Than Threshold: Every new acquired value is compared to a threshold.

$$Threshold_{greater} = x_n > Thr$$

Threshold high formula

$$Threshold_{less} = x_n < Thr$$

Threshold low formula

The user can configure 2 thresholds for the same input acquired value. If two thresholds are selected, different configurations can be set:

- Range threshold: $Thrmin < xn < Thrmax$ If a value is outside of a range defined by $Thrmin$ and $Thrmax$, the system will change its actions and behavior. The system will automatically define $Thrmin$ and $Thrmax$ upon a value defined by user.
- Successive threshold: $xn > Thr1 \ \& \ xn > Thr2$ or $xn < Thr1 \ \& \ xn < Thr2$. The user can have two levels of action and behavior when $Thr1$ and $Thr2$ is reached.
- **Actions:** When a threshold is reached, the system will set a flag. This flag is available on advertisement frame. Upon user configuration the system can change the advertisement mode and measurement interval. This configuration can be done on BLE connected mode.
- **Behavior:** This new configuration can last while the threshold is reached or until user clears the threshold flag. Configurations can be performed in BLE connected mode.

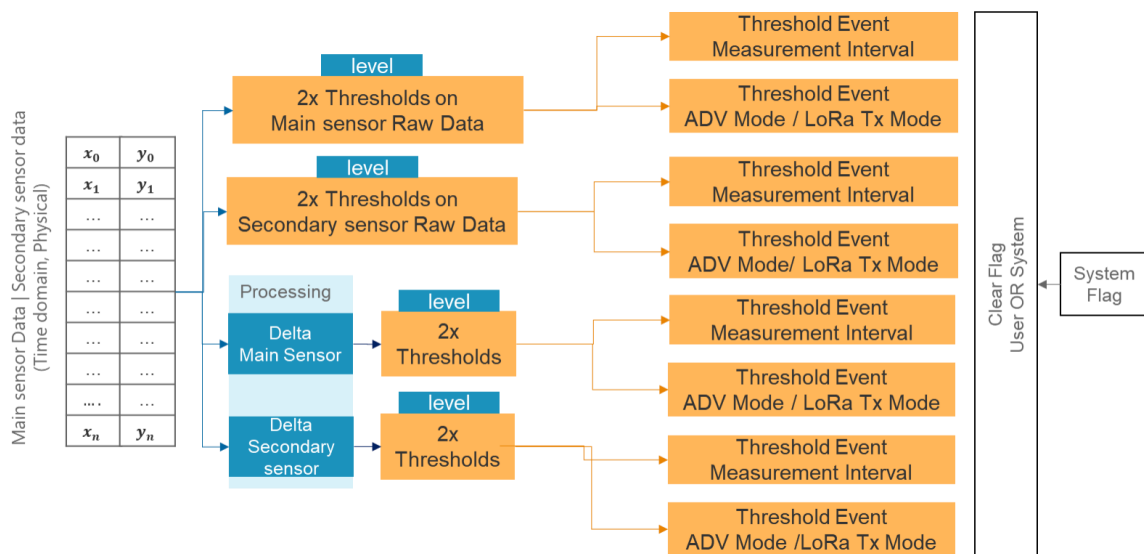

Threshold manager bloc diagram

At configuration, the user needs to define:

- Data to consider: main sensor and/or secondary sensor
- Data to use: raw data and/or Delta
- Threshold level and type: “greater than” or “less than”
- Event after threshold: flag, measurement interval, Advertisement mode

Every newly acquired value is compared to a defined threshold. The sensor will then complete a specific action and behavior that is defined by the user:

- Set up flags to inform the user that a threshold is reached
- Change BLE Advertisement mode (only on event mode activated)
- Change measurement interval (only on event mode activation)

If there are conflicts when several thresholds are reached:

- System will use the lowest measurement interval and at each new threshold reached or released, a new configuration analysis will be performed.

3.6 Bluetooth® Communication

3.6.1 Bluetooth® Connected Mode

Users can connect to the system with a Bluetooth® device such as a computer, smartphone, or tablet. BLE connected mode enables configuration, access to special functions and firmware updates.

The product is embedded with 2 different BLE connected modes, which are listed below:

Operating mode	Description	Condition
Standard	User mode to configure the sensor and activate some specific function only available when connected	None
DFU	Mode used during FW update.	OTA update

Note: If the device is in BLE connected mode and a power off (remove the battery) occurs without being disconnected from the central device, configuration will be lost.

3.6.2 Access to Connected mode

To access connected mode, the user should use a BLE enabled device. When an advertisement is sent by the system, the BLE device will be able to make the connection.

3.6.3 Exiting from Connected mode

When in connected mode, there are two ways to disconnect:

- Use the disconnect software function on the BLE central device

- Use the magnet to disconnect

3.6.4 Device Firmware Update (DFU Mode) :

DFU mode should be used to upgrade the sensor firmware. It is accessible from the standard operating mode.



Firmware updates will be assigned by TE Connectivity.



The DFU works with a single bank only. This means that if the firmware update is interrupted (power cut off or BLE disconnection), the application firmware will be corrupted, and the sensor will stay in DFU mode. The user will have to retry the upgrading process. Note that the DFU MAC address is the sensor MAC address +1.

3.6.5 List of services available

Users on the BLE connected mode can access a list of services. Each service includes characteristics which allow the user to configure the sensor.

Every service and characteristic share a common UUID. Only bytes #3 and #4 (XXXX) differ from the identifier.

BLE UUID	B614XXXX-B14A-40A6-B63F-0166F7868E13
UUID Service key	XXXX

3.7 PAYLOAD description

3.7.1 Keep Alive

ADVERTISEMENT GENERIC												
byte	0	1	2	3	4	5	6	7	8	9	10	
field	CI		DEVTYPE		CUSTOM ADVERTISING DATA				CNT		DEV STAT	

- CI: Company identifier, 0xDE08
- DEVTYPE: Information about the product
- CUSTOM ADV DATA: 4-byte array
- CNT: measurement counter
- DEVSTAT: System global status
- BATT: Battery level

3.7.2 Bluetooth® Generic Advertising message format

ADVERTISEMENT GENERIC																				
byte	0	1	2	3	4	5	6	7	8	9	10	11	12	13	14	15	16	17		
field	CI		DEVTYPE		CUSTOM ADVERTISING DATA				CNT		DEV STAT		BATT		TEMP		SENSOR32			

- CI: Company identifier, 0x08DE
- DEVTYPE: Information about the product
- CUSTOM ADV DATA: 4-byte array
- CNT: measurement counter
- DEVSTAT: System global status
- BATT: Battery level
- TEMP: Secondary data from sensor 2-Byte.
- SENSOR32: Main data from the sensor 4-Byte
SENSOR32 data type is defined by DEVTYPE output field

3.7.3 Global overview of payload available depending on communication

Function	Service Address	Information	Characteristic Address	Payload size (Bytes)	BLE
Generic access	1800	Device Name	2A00	25	Connected: R
		Appearance	2A01	2	Connected: R
		Peripheral Preferred Connection Parameters	2A04	8	Connected: R
		Central Address Resolution	2AA6	1	Connected: R
Generic Attribute	1801	Service Change	2A05	0	Connected: R
Device information	180A	Model Number	2A24	6	Connected: R
		Serial Number	2A25	13	Connected: R
		Firmware revision	2A26	23	Connected: R
		Hardware revision	2A27	7	Connected: R
		Manufacturer	2A29	9	Connected: R
Device	FC00	Device status	FC01	1	Connected: R/N Advertising: R
Battery	180F	Battery level	2A19	1	Connected: R/W Advertising: R
Bluetooth®	CD00	Customer Specific Data	CD01	4	Connected: R/W Advertising: R
		BLE Adv Mode Configuration	CD02	1	Connected: R/W
		Change Device Name	CD03	25	Connected: R/W ScanResp: R
Environmental sensing	181A	Internal platform temperature	2A6E	2	Connected: R/N
Keep Alive	CE00	Keep Alive configuration	CE01	1	Connected: R/W
Data collection	B300	Measurement Counter	B301	2	Connected: R/W/N Advertising: R
		Measurement interval	B302	3	Connected: R/W
		Trig measurement	B303	1	Connected: W
Last data from sensor	DA00	Last data acquired	DA01	6	Connected: R/N Advertising: R
Live Mode	B400	Live Measurement interval	B401	1	Connected: R
		Live mode configuration	B402	1	Connected: R/W
Threshold	B200	Threshold	B201	5	Connected: R/W/N
Datalog Raw value	DB00	Datalog data	DB01	/	Connected: R/W/N

Note1: Two BLE generics services are embedded into the sensor:

- GENERIC ATTRIBUTE
- GENERIC ACCESS

They are mandatory for BLE use.

Note2: All bytes into a frame are coded in BigEndian when used with a TE custom service
 All bytes into a frame are coded in LittleEndian when linked with BLE standard
 When specific code is implemented, a note is added into description.

Note3: All array of byte is code in BigEndian

Note4: Serial Number is the BLE MAC Address

Note5: When a byte is composed of bit fields, unused bits must remain set to “0”.
 Setting an empty or unused bit might create unexpected behavior of the sensor when writing into a bit field register.

3.7.4 Device status

DEVICE STATUS								
byte	0							
bit	7	6	5	4	3	2	1	0
field	SENSOR_ Error	CONFIG_ Error	RESERVED	CONDITION	SYSTEM PHASE			Battery_ Error

- **SENSOR_Error:** Sensor error (more details on Sensor diagnosis)
- **CFG_Error:** Configuration Error (Reserved for future use)
- **CONDITION:** Threshold related

SYSTEM PHASE:

System Phase	Value
Preliminary ((ex:1rst hours))	1
Nominal	0

BATT_Error: Battery error (more details on Battery diagnosis)

3.7.5 Device Type

DEVTYPE: Information about the product

DT VALUE																
Bit	15	14	13	12	11	10	9	8	7	6	5	4	3	2	1	0
	SW Platform				Sensor				Wireless				Output Type SENSOR32			
	0	Error			0	Error			0	Error			0	Error		
	1	Platform_21			1	Vibration			1	BLE			1	Float		
					2	Temperature			2	BLE / LoRaWAN (<i>Not applicable</i>)			2	Integer		
					3	Pressure										
					4	Humidity										

Example for a pressure BLE only product will be:

DT Value	Description
0x1311	Pressure Generic BLE with a float data type

3.7.6 Diagnosis

3.7.6.1 Sensor diagnosis

Sensor diagnosis								
bit	7	6	5	4	3	2	1	0
field	TEMP16_OoR_ ERR	TEMP16_CRC_ ERR	TEMP16_CAL_ ERR	TEMP16_CIR_ ERR	SENSOR32_OoR_ ERR	SENSOR32_CRC_ ERR	SENSOR32_CAL_ ERR	SENSOR32_CIR_ ERR

- **TEMP16_OoR:** Secondary sensor data out of range.
Pressure: -40°C +85°C or data is unreliable (Pressure sensor operation T° range -30°C to +75°C)
- **TEMP16_CRC_ERR:** Secondary sensor data read error (CRC error)
- **TEMP16_CAL_ERR:** Secondary sensor calibration error (not possible to read from EEPROM or not calibrated in ROM)

- **TEMP16_CIR_ERR**: Secondary sensor circuitry error (no answer from sensor). It concerns the acquisition of the sensor and the sensor calibration reading.
- **SENSOR32_OoR**: Main sensor data out of range or unreliable. Embedded into Register address (0x40)
- **SENSOR32_CRC_ERR**: Main sensor data read error (CRC data error)
- **SENSOR32_CAL_ERR**: Main sensor calibration error (not possible to read from EEPROM or not calibrated in ROM)
- **SENSOR32_CIR_ERR**: Main sensor circuitry error (No answer from sensor)

3.7.6.2 Battery diagnosis

Sensor diagnosis								
bit	7	6	5	4	3	2	1	0
field						BATTERY_WARNING	BATTERY_LOW	BATTERY_CHANGE

BATTERY_Warning:

Voltage drop occurs during Measurement, or Communication, or Sleep mode:

- Measurement continues (In case of voltage drop during measure data into frame is replaced by NaN or 7FFFFFFF).
- Communication continues

State	Value
No battery warning	0
Battery warning occurs	1

BATTERY_Low: Battery capacity is below 15%

User should plan a battery change:

- Measurement continues
- Communication continues

State	Value
No battery issues	0
Battery low	1

BATTERY_Change: Several voltage issues occur during sleep or communication.

User should change the battery:

- Measurement is stopped
- Communication is only keep alive

State	Value
No battery change	0
Battery Change Requested	1

3.7.7 Battery

BATTERY								
bit	7	6	5	4	3	2	1	0
field	BATTERY8							

BATTERY8: Percentage of remaining battery. Writing 0xFF in this register will reset the battery algorithm to 100%.

Other values written here will be ignored.

3.7.8 Bluetooth®

3.7.8.1 Customer specific data

CAD			
3	2	1	0
CAD			

CAD: Custom Advertisement Data: 4Bytes

3.7.8.2 BLE Adv Mode Configuration

ADV_CFG								
bit	7	6	5	4	3	2	1	0
field	ADV_MUTE						ADV_MODE	

ADV_MUTE: When the external device is connected, the system stops advertising until the next event or measurement if this flag is set. Flag is reset on next event.

ADV_MODE:

Mode	Value	Description
ADV Burst + Periodic Mode	0	Advertisement 15 times every second after measurement then every 10 seconds
ADV On Measure Burst Mode	1	Advertisement 15 times every second only after a measurement.
ADV Silent Mode	2	No advertisement included even after measurement.
ADV Periodic Mode	3	Advertise periodically

3.7.8.3 Advertisement interval for ADV Periodic Mode

Interval between two advertisements **when ADV Periodic mode is selected.**

ADV_Interval								
bit	7	6	5	4	3	2	1	0
field						ADV_INTERVAL_PERIODIC_ONLY ADV periodic mode only		

ADV_INTERVAL_PERIODIC_ONLY: (ADV periodic mode only)

Value	Description
0	Advertisement every 500ms
1	Advertisement every 1s.
2	Advertisement every 1,5s.
3	Advertisement every 2s.
4	Advertisement every 3s.
5	Advertisement every 4s.
6	Advertisement every 5s.
7	Advertisement every 10s.

Note1: Default value is 10s. Minimum value is 500ms.

Note2: This value can be only use for ADV Periodic.

3.7.8.4 Change Device Name

Change device name characteristic allows customer to change device name.

Device Name							
24	-	5	4	3	2	1	0
DEVICE NAME							

DEVICE NAME: Device name when BLE scan: 25Byte

Note1: Only ASCII characters are permitted.

Note2: Any (0x00) \0 is recognized as an end of string.

Note3: Value returned is a string (without \0 at the end)

3.7.9 Internal platform temperature

INTERNAL_TEMPERATURE16																
Bit	15	14	13	12	11	10	9	8	7	6	5	4	3	2	1	0
field	INTERNAL_TEMPERATURE16															

INTERNAL_TEMPERATURE16 (signed): Internal temperature of the platform

$$TEMP_{\circ C} = INTERNAL_TEMPERATURE16 * 0.01$$

3.7.10 Data Collection

3.7.10.1 Measurement Counter

MEASUREMENT COUNTER (R/W)																
Bit	15	14	13	12	11	10	9	8	7	6	5	4	3	2	1	0
field	CNT16															

CNT16: Number of measurements done. When it reaches 0xFFFF it will reset to 0x0000. Writing 0x0000 will reset the counter to 0x0000. Other values won't affect current counter.

3.7.10.2 Measurement interval

Interval between two measurements.

MEAS_INTERVAL						
Byte	0		1		2	
field	HOUR8		MINUTE8		SECOND8	

- **HOUR8:** Number of hours [0-255]
- **MINUTE8:** Number of minutes [0-255]
- **SECOND8:** Number of seconds [0-255]
- MEAS_INTERVAL = "HOUR8" & "MINUTE8" & "SECOND8"

Note1: Default value is 10 minutes. Minimum value is 1 second. Value 0x000 (0h0min0s) is not considered.

Note 2: It is possible to write values only in minutes (ex:120min). The system will automatically transform the value into standard time representation (ex:120min => 2hours).

Note 3: When the measurement interval is modified by user, next new measurement will be done after new measurement interval. System won't wait to end current measurement interval.

Note 4: Maximum value is HOUR8: FF MINUTE8: 3B SECOND8: 3B. (255h 59min 59s) If a written value exceeds this value, it won't be considered.

3.7.10.3 Trigger Measurement

TRIG MODE								
bit	7	6	5	4	3	2	1	0
field	DISCON							TRIG

TRIG: trig a new measurement flow (read raw values, temperature, battery and process the data)

Trig	Value
Disabled	0
Ask a new measurement	1

DISCON: force BLE disconnection before measurement trig

Trig	Value
Disabled	0
BLE connected mode disconnection	1

Note: Only 0x81 and 0x01 are allowed.

3.7.10.4 Last data from sensor

Last data acquired from the sensor:

Last data						
Byte	0	1	2	3	4	5
field	TEMP16		SENSOR32			

TEMP16: Temperature of the sensor

Sensor Type	TEMP16	Format/Unit
Pressure	T°C	Big Endian Signed 16bit 1LSB = 0.01°C

SENSOR32 (signed): Data from the sensor

Sensor Type	SENSOR32	Format/Unit
Pressure	Pressure Bar	Big Endian Float 32bit

Pressure Full Scale (FS) (bar)	Resolution (bar)
2	0.000001
7	0.0000035
20	0.00001
35	0.0000175
200	0.0001
350	0.000175

3.7.11 Live mode

3.7.11.1 Measurement interval

This mode is only available over BLE connection.

LIVE_MODE_MEAS_INTERVAL								
bit	7	6	5	4	3	2	1	0
field	LIVE_MODE_MEAS_INTERVAL8							

MEAS_LIVE_INTERVAL8: Read Only value in milliseconds.

3.7.11.2 Live mode configuration

LIVE_MODE_CFG								
bit	7	6	5	4	3	2	1	0
field								ENABLE

ENABLE: enable or disable Live mode.

Enable	Value
Disabled	0
Enabled	1

NOTE: Two ways are available to stop “Live mode”:

- BLE disconnection from the central device or with the magnet
- Send Live Mode disable request to LIVE_MODE_CFG

3.7.12 Threshold

To request threshold parameters, use the following frame:

Request Threshold information		
byte	0	1
field	ID DATA	PARAM SEL

Sensor will respond with the following frame:

Answer after a Read request						
byte	0	1	2	3	4	5
field	ID DATA	PARAM SEL	DATA32			

To write threshold parameters:

Write Threshold Configuration						
byte	0	1	2	3	4	5
field	ID DATA	PARAM SEL	DATA32			

ID_DATA: defines the source for threshold value

Source		Value
Main sensor raw data threshold 1	<i>pressure sensor (P)</i>	0x0
Main sensor Delta threshold 1		0x1
Secondary sensor raw data threshold 1	<i>Temperature into sensor (P)</i>	0x2
Secondary sensor Delta threshold 1		0x3
Main sensor raw data threshold 2	<i>pressure sensor (P)</i>	0x4
Main sensor Delta threshold 2		0x5
Secondary sensor raw data threshold 2	<i>Temperature into sensor (P)</i>	0x6
Secondary sensor Delta threshold 2		0x7
Error	ID_DATA not defined or threshold configuration error	0xF

!The temperature provided is used for internal processing and should not be used as accurate temperature data!

PARAM SEL: Select parameters to be changed (more details below)

	Value
THS_CONFIG	0x0
THS_LEVEL	0x1
MEAS_INTERVAL	0x2
Communication_MODE	0x3

- **PARAM SEL=0x0** (Threshold configuration)

This command can be used with multiple parameters.

Data32 format:

THS_CONFIG																																
Byte	3							2							1							0										
bit	7	6	5	4	3	2	1	0	7	6	5	4	3	2	1	0	7	6	5	4	3	2	1	0	7	6	5	4	3	2	1	0
field	EVT_FLAG	THRESHOLD	CONDITION	AUTO_CLR	ACTION: MEAS	ACTION: ADV MODE																										

EVT_FLAG: Forcing this bit to 0 clears the event flag until the next trigger

State	Value
No event detected	0
Threshold event detected	1

THRESHOLD ENABLE:

State	Value
Deactivated	0
Threshold activated	1

CONDITION: Define the threshold condition

Condition	Value
Data32 < Threshold Level	0
Data32 > Threshold Level	1

AUTO_CLR: Auto clear once event condition

State	Value
Keep flag even if the threshold is ended	0
Auto clear Flag after threshold end	1

ACTION: MEAS_INTERVAL: Change Measurement Interval after the threshold level reached

State	Value
Disabled	0
Change measurement interval after threshold	1

ACTION: ADV MODE BLE: Change Advertisement Mode after the threshold level reached

State	Value
Disabled	0
Change ADV Mode BLE after threshold	1

PARAM SEL=0x1 Data32 format: Threshold level

THS_LEVEL				
Byte	3	2	1	0
field	INT32 / FLOAT32			
	N/A		INT16	

Same data format as SENSOR32 /TEMP16

Default value: 0x0

- **PARAM SEL=0x2** Data32 format: Measurement interval after a threshold reached

MEAS_INTERVAL				
Byte	3	2	1	0
field	HOURL8	MINUTE8	SECONDE8	0 (Not Use)

Note1: Default value is 1 minute. Minimum value is 1 second.

Note2: Value 0x000 (0h0min0s) is not considered.

Note3: Maximum value is HOURL8: 0xFF MINUTE8: 0x3B SECONDE8: 0x3B.

(255h 59min 59s) If a written value exceeds this value, it will not be considered.

- **PARAM SEL=0x3** Data32 format: Communication mode after a threshold reached

THS_COMM_MODE																																							
Byte	3							2							1							0																	
bit	7	6	5	4	3	2	1	0	7	6	5	4	3	2	1	0	7	6	5	4	3	2	1	0	7	6	5	4	3	2	1	0							
field							BLE_ADV_MODE																																

BLE_ADV_MODE:

Mode	Value	Description
Periodic mode	0	Advertisement 15 times after measurement then every 10 seconds
On Measure mode	1	Advertisement only after a measurement (15 consecutive ADV)
ADV Silent mode	2	No advertisement included even after measurement
Periodic mode	3	Periodic advertisement

3.7.13 Datalog

3.7.13.1 Datalog array access request

ARRAY ACCESS REQUEST				
byte	0	1	2	3
field	TYPE8	INDEX16		LENGTH8

- **TYPE8:** Data (0 = TEMPERATURE16, 1 = SENSOR32, 2 = TEMPERATURE16 + SENSOR32).
- **INDEX16:** start index from 0 up to 4095 for Raw data (MSB first)
0=latest data acquired, 4095= oldest data acquired
- **LENGTH8:** number of values to be read. Admissible range depends on TYPE8:
 - 1-120 for TYPE8=TEMPERATURE16
 - 1-60 for TYPE8=SENSOR32
 - 1-40 for TYPE8= TEMPERATURE16 + SENSOR32

If the required length is larger than network capabilities, the frame will be filled with the maximum possible data. No data will be truncated.

3.7.13.2 Datalog array access response with notification:

ARRAY ACCESS RESPONSE									
byte	0	1	2	3			-	m-1	m
field	TYPE8	INDEX16	LENGTH8	VALUE_0				VALUE_n	

- **TYPE8:** Data (0 = TEMPERATURE16, 1 = SENSOR32, 2 = TEMP16 + SENSOR32).
- **INDEX16:** start index of the value
- **LENGTH8:** number of values sent
- **VALUE_n:** SENSOR32 or TEMP16 or SENSOR32 + TEMP16. For TEMP16 the 1st Byte is filled of 0.

Note: In case of error, ARRAY ACCESS RESPONSE will be 0xFFFFFFFF.

3.7.13.3 Datalog analysis request

DATALOG STATISTIC REQUEST			
byte	0	1	2
field	TYPE8	LENGTH16	

- **TYPE8:** Value = 2

Analysis of TEMPERATURE16 and SENSOR32

Data format depends on sensor type. Please refer to DEVTYPE.

- **LENGTH16:** number of values to be analyzed.

If the length required exceeds the amount of data currently stored, system will use only available data.

The first data to be use will be last acquired data.

3.7.13.4 Datalog statistics response with notification

DATALOG STATISTIC RESPONSE																			
byte	0	1	2	3	4	5	6	7	8	9	10	11-14	15-18	19-22	23-26				
field	TY PE 8	SIZE16		MEAN_ T		MIN_T		MAX_T		STD_T		MEAN_ _S		MIN_S		MAX_S		STD_S	

- **TYPE8:** Value= 2 (TEMPERATURE16 + SENSOR32).
- **SIZE16:** nb value used for computation
- **MEAN_T** Mean value of batch data analyzed for temperature
- **MIN_T** Min value of batch data analyzed for temperature
- **MAX_T** Max value of batch data analyzed for temperature
- **STD_T** Standard deviation value of batch data analyzed for temperature
- **MEAN_S** Mean value of batch data analyzed for SENSOR32
- **MIN_S** Min value of batch data analyzed for SENSOR32
- **MAX_S** Max value of batch data analyzed for SENSOR32
- **STD_S** Standard deviation value of batch data analyzed for SENSOR32

Note: In case of error, ARRAY ACCESS RESPONSE will be 0xFFFFFFFF.

Note: Format depends on data type. Please refer to DEVTYPE.

4 BATTERY

4.1 Saft LS17330

The system should be exclusively powered with an LS17330 battery.

Parameters	Typical value
Manufacturer	SAFT
Reference	LS 17330
Technology	Primary lithium-thionyl chloride (Li-SOCl ₂)
Nominal voltage	3.6 V
Capacity at 20°C	2100 mA
Operating temperature range	- 60°C/+ 85°C

4.2 Battery life

Depending on customer settings the battery life could extend to 10 years (dependent on measurement interval and RF communication).

The number of measurements per day will affect the battery life. More measurements will reduce the battery life.

Temperature and battery depletion can have an effect on the behavior of the system. When the temperature is higher than +60°C or lower than -30°C the electrical current availability may be reduced. A related voltage drop can affect system stability.

We have implemented some firmware mechanisms to detect this critical voltage drop. Dedicated mechanisms are implemented into:

- Sleep phase
- Measurement phase
- Communication phase

Mechanisms are based on:

- Integrated MCU voltage monitoring (POFWARN= Power Failure Warning). It will trigger a flag when voltage drops below a defined level.
- MCU internal temperature monitoring (Environmental Sensing Service)

Sleep phase: POFWARN is set at 2.8V.

During sleep phase, if the system had several voltages drops detected (11 consecutive times) and the temperature is between [-30°C +60°C], this means that the battery may have an issue. If this issue happens several times (11 consecutive times), the system sets a battery change flag.

If the temperature is below -30°C and higher than +60°C and voltage drops are detected (10 consecutive times), the system sets a battery warning flag and will wait to be in nominal range [-30°C +60°C] to define if a battery change should be declared.

Measurement phase: POFWARN is set at 2.8V

During a measurement process POFWARN is activated to define if measurements acquired by the system are reliable.

If a voltage drop is detected during measurement, a specific measurement health process is activated to define if voltage drop happens at each measurement. If yes, the measurement value is set to 0x7FFFFFFF/NaN/7FFF. Sensor_Error, TEMP16_OOR_ERR, SENSOR32_OOR_ERR and Battery Warning is set to 1.

Communication phase: POFWARN is set at 2.0V

Communication phase has a memory effect about voltage drop. If a POFWARN happens it will be sent on next communication. Note if a POFWARN happens, communication frame can be sent properly.

If system remains in this communication phase for 10 consecutive intervals, BATTERY_Diag Change will be set to 1.

6.2 BATTERY REPLACEMENT

The 65XXN's battery must be replaced if depleted.

- Remove the plastic cover following the opening directions
- Use the orange ribbon to pull out the battery
- Put the orange ribbon back to the cavity before installing the new battery.
Note: the battery MUST be replaced by the same battery reference (SAFT LS17330.)
- Put the spacer on the negative terminal and install the battery positive upward
- Pull the spacer out and then install the plastic cover and tighten it following the locking direction. Refer to the Installation Manual or the Quick Start Guide for details of battery installation and replacement.

N.B.: Only replace the battery in non-hazardous areas.

Once the battery installation is complete, the battery life meter in the firmware must be reset to a “full” battery status.

!This action is mandatory otherwise battery level will stay at 0%!

5 MAGNETIC SWITCH

To make an asynchronous data acquisition, or access BLE connected mode, use a magnet. The magnet event will trigger a measurement, then the sensor will be in Preliminary Phase. The magnetic switch location is indicated by the magnet drawing on the plastic cover.

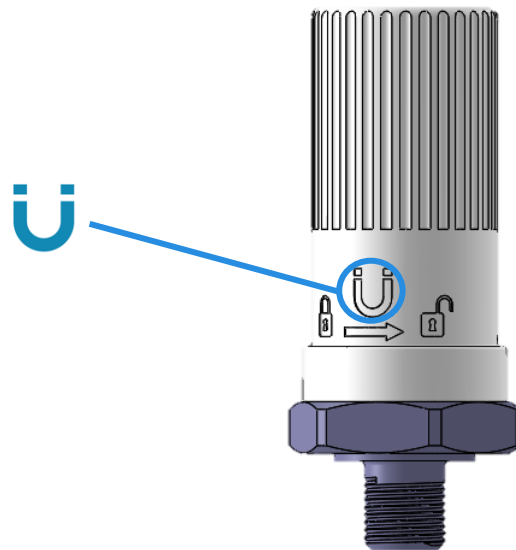

The magnet must be of sufficient strength and proximity to create a magnetic field of 25 mT at the switch location.

Two different functions are available depending on the user action:

Function	User action	LED
Activates BLE preliminary phase Trigs a new measurement Disconnect from BLE connected mode	Short tap	One fast blink. If user holds the magnet close to the switch for a longer duration, the LED will blink faster. Remove the magnet to only initiate a transmission, or else a sensor reset will be initiated
System Restart	Hold the magnet for 10 seconds.	Wait for at least 10 seconds, to see the very fast blink. Release the magnet once a very long orange led appears

6 LED

A yellow LED is used to indicate user some specific event:

		LED Behavior
Battery insertion		ON for 2s
Magnet event		ON for 200ms
Maintaining Magnet	<3s	Slow blinking
	[3s-10s]	Short blinking
	>10s	OFF -> reboot

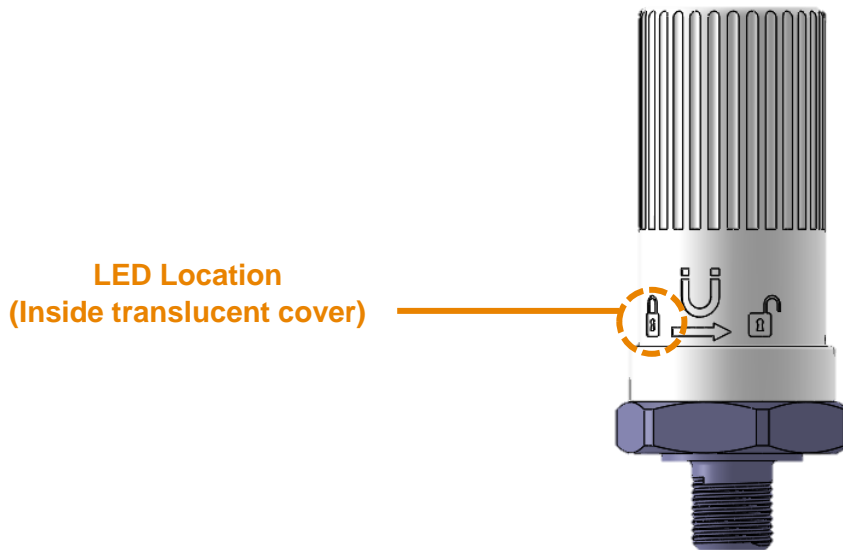

7 DIMENSIONS

Dimensions units: Inches [Millimeter]

COMPOUND TYPE CRITICAL DIMENSIONS

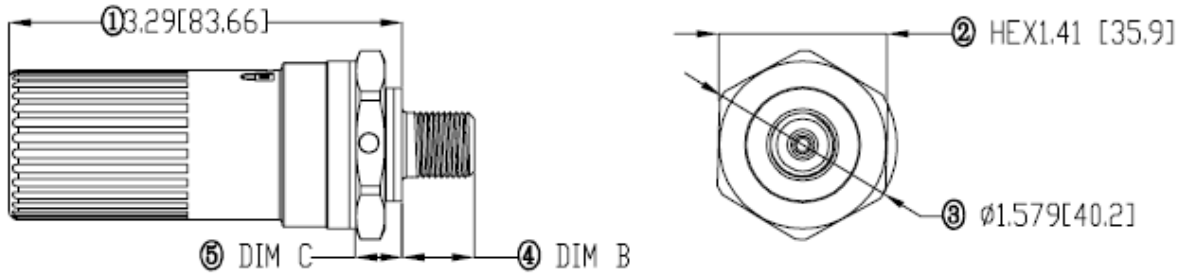

ABSOLUTE TYPE CRITICAL DIMENSIONS

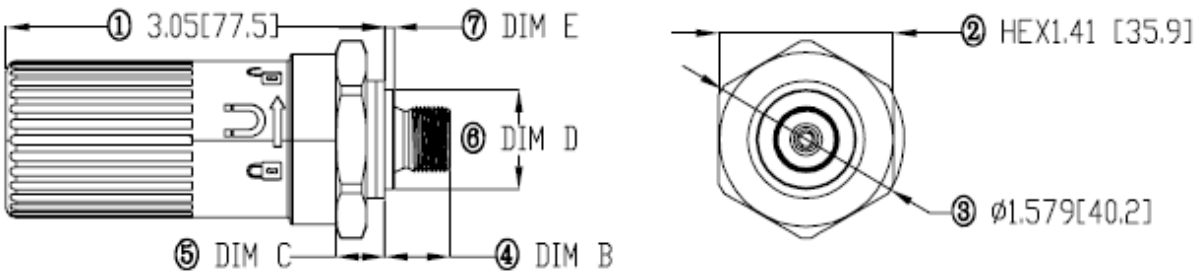

PORT TYPE	PRESSURE RANGE	DIM B TYP.	DIM D TYP.	DIM E TYP.
1/4-18 NPT	2 BAR	0.60 [15.24]	NA	NA
	7 BAR			
	20 BAR			
	35 BAR			
	200 BAR 350 BAR			
1/4-19 BSPP	2 BAR	0.526 [13.36]	0.80 [20.32]	0.075 [1.905]
	7 BAR			
	20 BAR			
	35 BAR			
	200 BAR 350 BAR			

Pressure Range	PRESSURE REF	DIM C TYP.
2, 7, 20, 35 BAR	ABSOLUTE	0.397 [10.08]
	COMPOUND	0.391 [9.92]
200, 350 BAR	ABSOLUTE COMPOUND	0.397 [10.08]

8 MOUNTING CONSIDERATIONS

The pressure sensor should be installed on a clean and compatible thread, the use of an open-end wrench is recommended.

For the ¼ NPT thread the use of pipe thread sealant or Teflon tape is recommended. The NPT threaded part should be tightened 2~3 turns from finger tight (TFFT).

For ¼ BSPP threads, mounting torque for the sensor of pressure ranges 2 to 35 bar should not exceed 30Nm, and for sensors with ranges over 200 bar the mounting torque should not exceed 35 Nm.

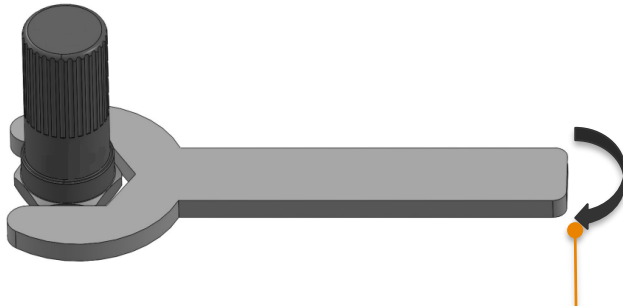

Pressure Sensor Range **2 to 35 Bar**, max torque is **30Nm**.
Pressure Sensor Range **200 and 350 Bar**, max torque is **35Nm**



Open end wrench size:
1-7/16in or 36mm

Assembly torque depends on many factors, particularly the lubrication, the coating and the surface finish.

!The user should qualify the tighten torque in their application!

WARNING – Do NOT tighten the sensor by twisting on the housing. Damage to the sensor WILL occur. Tighten to the correct torque using a wrench on the hex base.

WARNING – Install in a process connection with enough room to allow the use of spanner/wrench.

WARNING – To reduce the risk of burns or frost bite, wear protective personal equipment when installing or removing from high or below-freezing temperature environments.

WARNING – After installation carefully check for leaks.

9 CERTIFICATIONS & COMPLIANCES

This Equipment is certified for Intrinsic Safety when model code “EX” is selected during the ordering process. Please see ordering information in section 12 for details:

Intrinsic Safety approval is as follows:

IS Class I, Div1, Groups A, B, C, and D;

Class I Zone 0, AEx ia IIC T4 Ga;

Ex ia IIC T4 Ga;

 II 1 G Ex ia IIC T4 Ga

10 REGULATORY STATEMENTS

FCC and IC

This Radio Equipment is Certified for FCC (US) and ISED (Canada).

This equipment does not support simultaneous transmissions.

Changes or modifications not expressly approved or authorized by TE Connectivity for compliance could void the user's authority to operate the equipment.

FCC Warning:

THIS DEVICE COMPLIES WITH PART 15 OF THE FCC RULES. OPERATION IS SUBJECT TO THE FOLLOWING TWO CONDITIONS: (1) THIS DEVICE MAY NOT CAUSE HARMFUL INTERFERENCE, AND (2) THIS DEVICE MUST ACCEPT ANY INTERFERENCE RECEIVED, INCLUDING INTERFERENCE THAT MAY CAUSE UNDESIRE OPERATION.

Note: This equipment has been tested and found to comply with the limits for a Class B digital device, pursuant to Part 15 of the FCC Rules. These limits are designed to provide reasonable protection against harmful interference in a residential installation. This equipment generates, uses, and can radiate radio frequency energy and, if not installed and used in accordance with the instructions, may cause harmful interference to radio communications. However, there is no guarantee that interference will not occur in a particular installation. If this equipment does not cause harmful interference to radio or television reception, which can be determined by turning the equipment off and on, the user is encouraged to correct the interference by one or more of the following measures:

- Reorient or relocate the receiving antenna
- Increase the separation between the equipment and the receiver

- Connect the equipment to an outlet on a circuit that is different from that to which the receiver is connected.
- Consult the dealer or an experienced radio/TV technician for help

Industry Canada (IC) Warning:

This device complies with ISED Canada license-exempt RSS standard(s). Operation is subject to the following two conditions: (1) this device may not cause interference, and (2) this device must accept any interference, including interference that may cause undesired operation of the device.

Le présent appareil est conforme aux CNR d'ISED Canada applicables aux appareils radio exempts de licence. L'exploitation est autorisée aux deux conditions suivantes : (1) l'appareil ne doit pas produire de brouillage, et (2) l'appareil doit accepter tout brouillage radioélectrique subi, même si le brouillage est susceptible d'en compromettre le fonctionnement.

IMPORTANT NOTE:

Radiation Exposure Statement: This equipment complies with IC radiation exposure limits set forth for an uncontrolled environment. End users must follow the specific operating instructions for satisfying RF exposure compliance. To maintain compliance with IC RF exposure compliance requirement, please follow operation instruction as documented in this manual.

Déclaration d'exposition aux radiations

Cet équipement est conforme Canada limites d'exposition aux radiations dans un environnement non contrôlé. Cet équipement doit être installé et utilisé à distance minimum de 20cm entre le radiateur et votre corps.

A distance of 20cm shall be maintained between the antenna and users, and the transmitter may not be co-located with any other transmitter or antenna.

11 EU Conformity

The products below were tested by approved agencies and found compliant with EU regulatory standards.

Model Families: 65XXN

Product Description: Wireless Pressure Sensor

Manufacture/Brand: TE Connectivity Ltd

Manufacturer:

Measurement Specialties (China) LTD
No 26 LangShan Road
518057 Shenzhen-Nanshan District, China

European Contact:

TE Connectivity Sensors France
4 Rue Gaye Marie
31027 Toulouse – France

12 ORDERING INFORMATION

BLE Sensor Model Number

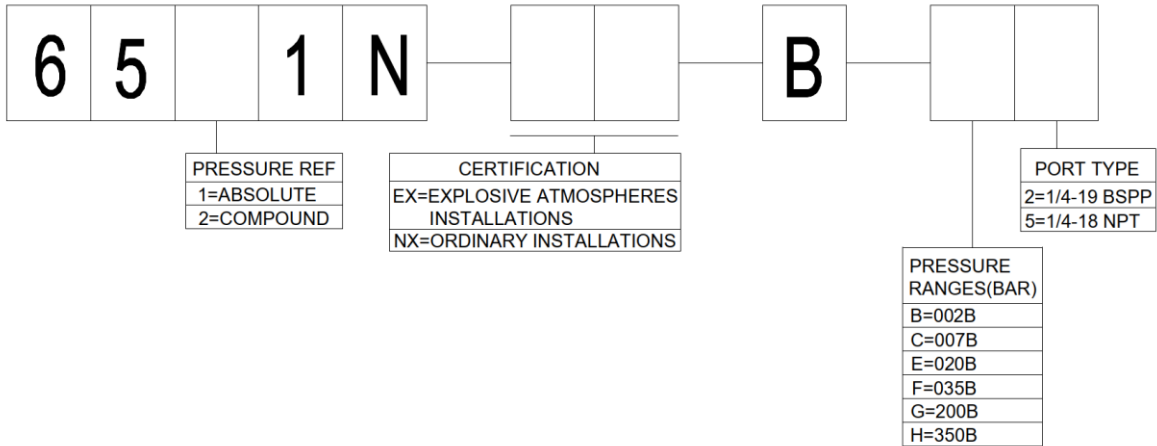

NORTH AMERICA
Tel +1 800 522 6752

EUROPE
Tel +31 73 624 6999

ASIA
Tel +86 0400 820 6015

te.com/sensors

TE Connectivity, TE, and TE connectivity (logo) are trademarks owned or licensed by the TE Connectivity Ltd. family of companies.

Apple, Google and Google Play are trademarks.

All other logos, products and/or company names referred to herein might be trademarks of their respective owners.

The information given herein, including drawings, illustrations and schematics which are intended for illustration purposes only, is believed to be reliable. However, TE Connectivity makes no warranties as to its accuracy or completeness and disclaims any liability in connection with its use. TE Connectivity's obligations shall only be as set forth in TE Connectivity's Standard Terms and Conditions of Sale for this product and in no case will TE Connectivity be liable for any incidental, indirect or consequential damages arising out of the sale, resale, use or misuse of the product. Users of TE Connectivity products should make their own evaluation to determine the suitability of each such product for the specific application.

© 2024 TE Connectivity Corporation. All Rights Reserved

Published 03-2024