

1. Production Description And Part Numbers

1.1 Housings

AMP Part Number*	Description
1318620	025 SERIES CONNECTOR 4P PLUG HOUSING
1376515 1612446	025 SERIES CONNECTOR 4P CAP HOUSING ASSEMBLY

Fig.1

*Note : Part number is consisted from listed base number and 1 digit numeric prefix and suffix with dash. Refer to catalog or customer drawing for specific part numbers for each base number. When prefix is zero, zero and dash are omitted.

1.2 Terminals

AMP Part Numbers	Description	Applicable Wire Sizes			
		Wire Type	0.22	0.3	0.5
1123343-1	025 Receptacle Contact (Sn)	CAVS	○	○	—
		AVSS	—	○	—
		CAVUS	○	○	○

Fig.2

2. Product Configuration

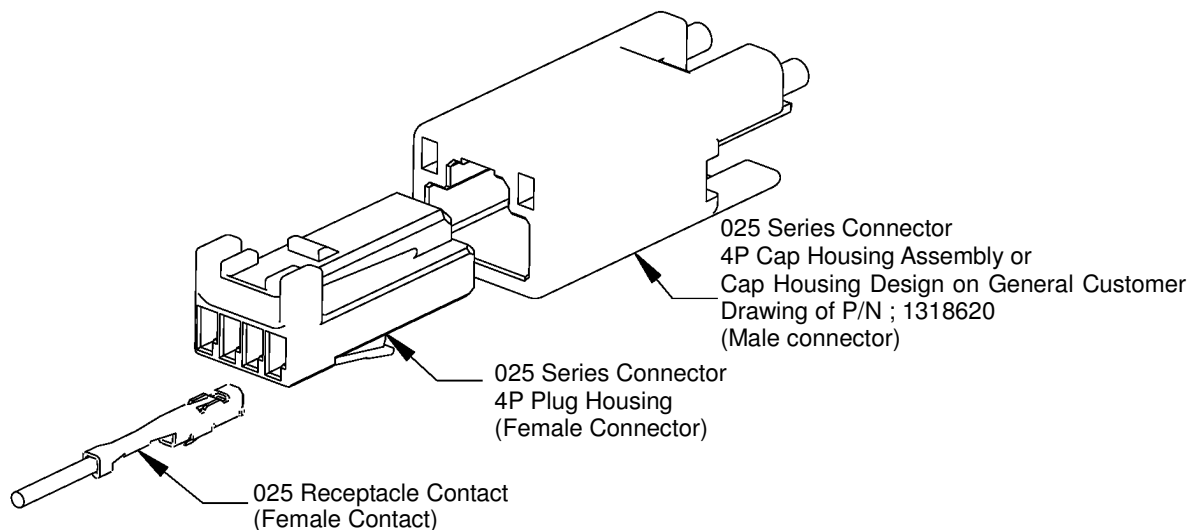

Fig.3

3. CUSTOMER RECEIVING INSPECTION

We conduct inspections according to our quality control regulations to maintain an over all LOT control. In addition, the customers should conduct receiving inspections based on the specific customer drawing.

3.1 Terminals

Items	Inspection rule and the way	Measurement Tool
Visual Inspection	1. Configuration And Appearance	Visual
	2. Plating Finish	Visual
	3. Reeling Status Of Strip Terminals	Visual
Dimensional Inspection	1. Width Of Wire Barrel	Callipers ⁽¹⁾
	2.Width Of Insulation Barrel	Callipers ⁽¹⁾

NOTE (1):Callipers are defined as vernier callipers or equivalent measuring tools, having the identical precision measurement level.

Fig.4

Upon Receiving, the reeled terminal products should be classified by manufacturing date codes and put under the inspection in accordance with the inspection level II of MIL-STD-105 at acceptable quality level of 4.0%, visually and dimensionally to check the first five terminals in reel.

Acceptable of the products is verified by proving the products meeting the specified requirements.

3.2 Housing

Items	Inspection rule and the way	Measurement Tool
Visual Inspection	1. Burrs, Discoloration and Deformation	Visual
	2. Cracks, Breakage and Chipping of	Visual
Functional Inspection	1. Mating Check to see if the connector mate smoothly with Gas Generator, and can not be extracted	Tactual

Fig.5

The product housings submitted to inspection are classified by the manufacturing date code, and put under the inspection in accordance with the inspection level II of MIL-STD-105, at acceptance quality level of 4.0% visually, and functionally to the randomly selected five pieced out of the lot.

Acceptance of the product is verified by proving the products meeting the specified requirements.

4. SAFEKEEPING AND CARRIAGE MANAGEMENT

4.1 Reeled Terminals

Avoid leaving terminal reel in an open area without wrapping it with proper material.

Do not lift up and carry the terminal reel by gripping it on the edge of the reel, lest it should result in damage of reel, causing spoiling of terminals before using them for application.

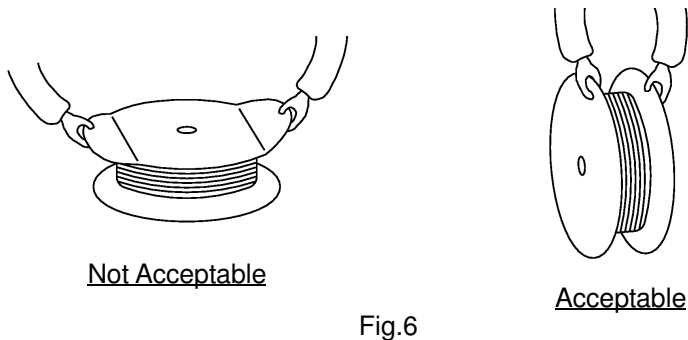

Avoid storing terminal reels in a moist area or dusty place. Stock contacts in a comparatively dry and clean place where the temperature of 5-35°C, with relative humidity ranging between 45-85% is maintained without keen influence of the direct sunlight.

When the terminal reel is not in use for a long time, remove it from the machine, and fasten the end of terminal strip onto the edge of reel with use of proper string or wire as shown in Fig.8.

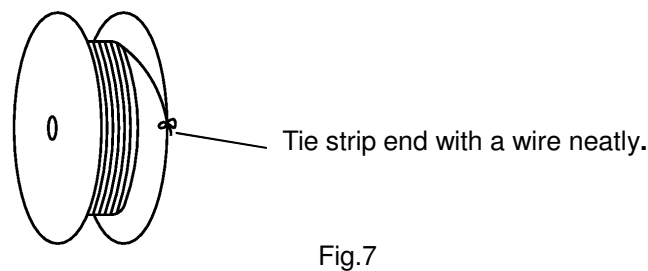

4.2 Housing

(1) It is desired that the products are placed where the temperature is ranging between 5-35°C with the relative humidity ranging between 45-85%.

(2) It is advised that leaving the products in open air for a long time tends to get contaminated by dust and particles.

Leaving under the open air for a long time should be forbidden from this point of view.

5. Mounting onto P.C.Board

Insert the contacts of the male connector into the hole of P.C.Board. Then solder the contacts after fixing the housing with thermal welding. And take care of the following at the work.

- (1) See the dimensions for P.C.Board on the customer drawing.
- (2) Do not deform the contact (P.C.Board side), otherwise the male connector can not be fixed on the P.C.Board.
- (3) The fixing with thermal welding should be provided respectively.
- (4) No discoloration nor deformation should be caused by the heat of soldering and thermal welding.
- (5) In addition, both side (mating side and solder side) of the contact and the housing must not be damaged or deformed by the operation. No foreign substances are permissible in the mating area.

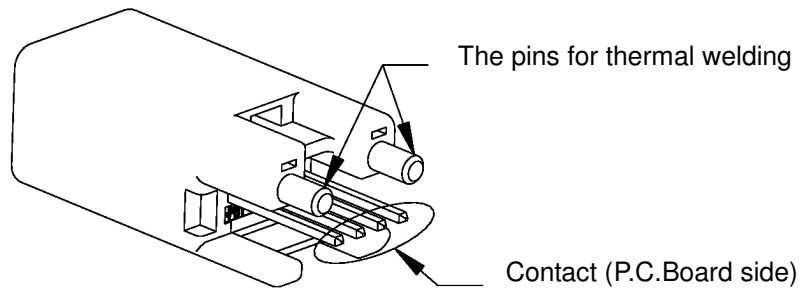

Fig.8

6. CRIMPING OPERATION

Crimping of contacts must be done by using AMP specified application tooling in accordance with the procedure specified in applicable instruction sheet.

6.1 Control of Crimping Operation

The documents listed below should be referred to for the specific details of crimping operation.

114-5250; Application Specification for 025 receptacle Contact

CM-022J; Operation and Maintenance of Auto-machine

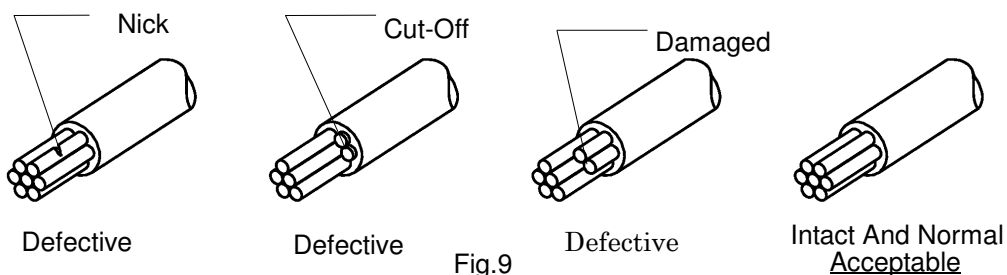

Fig.9

6.2 Applicable Wires

Refer to Fig.2

6.3 Management of Crimped In-process Products

6.3.1 Inspection of product

Inspection of crimped, in-process products must be performed by the lot unit consisting of the product groups manufactured during the one continuous operation under the same set-up adjustment of the crimping machine in the identical manufacturing conditions, or the groups of the produced products during one work day operation.

The inspection should be performed according to the criteria shown in the listing below.

Inspection Type	Timing	Inspection Item
Inspection on Products made under initial set up condition of applicator	At the time of completion of initial set-up of applicator to crimp the contact.	Visual inspection and Dimensional Inspection on all items listed in Fig.17
Lot Inspection	Before to start a routine operation each work day	
	During continuous operation	Visual inspection on all the items listed in Fig.17, and Dimensional Inspection on item No.3 only in Fig.10.

Fig.10

Items	Inspection Standard And The Way	Measurement Tool
Visual Inspection	1. Loose-out of the wire conductors out side the wire barrel crimp, and cut-off of conductors.	Visual
	2. Defective crimped form of contact (forming up of bell mouth, and wire end protrusion length).	Visual
	3. Defective wire barrel bottom area forming (burrs appearing, inclusive).	Visual
	4. Misgripping of insulation barrel crimp on wire insulation.	Visual
	5. Deformation of contacting area of contact.	Visual
Dimensional Inspection	1. Dimensions of Cut-off Tab Length.	Callipers ⁽¹⁾
	2. Deformation of contact (bend-up, lateral bend and twisting).	Magnifying Glass
	3. Crimp Height.	Micrometer
	4. Front and rear bellmouth forming.	Callipers ⁽¹⁾

Fig.11

NOTE (1):Callipers are defined as vernier callipers or equivalent measuring tools, having the identical precision measurement level.

6.3.2 Safekeeping And Treating

- (1) Store the products in the clean, dry area, and should be covered with proper sheet or paper when placed in an open area. Product storage without placing cover sheet when placed in an open air, should be forbidden always for prevention of contamination by dust and particles.
- (2) One bundle of in-process crimped leads, should be confined within 100 leads at anytime.
- (3) Avoid stacking and piling up the in-process products heaping up in large volume, lest it should result in catching together or entangled on the projecting parts of the leads, causing damage and breakage of the products. Deformation of the contact will result in malfunction of contacting parts electrically.
- (4) After crimping, at the time of taking into storage or transfer, beware not to have the leads entangled or caught together, and incurred to deformation of the contacts.
- (5) When to separate entangled parts apart, care must be taken not to jerk and pull forcefully with cross section area.

7.MANUFACTURING HARNESS ASSEMBLES

7.1 Confirmation Of Temporary Assembled Condition.

Confirm the position of the hinge part. Confirmation that the hinge part is in temporary assembled condition or opened condition in the case.

If being the condition that the hinge part was closed, Using a driver such as 1 mm blade screw

one, Turn up hinge part like the following figure and make it temporary assembled condition or opened condition.

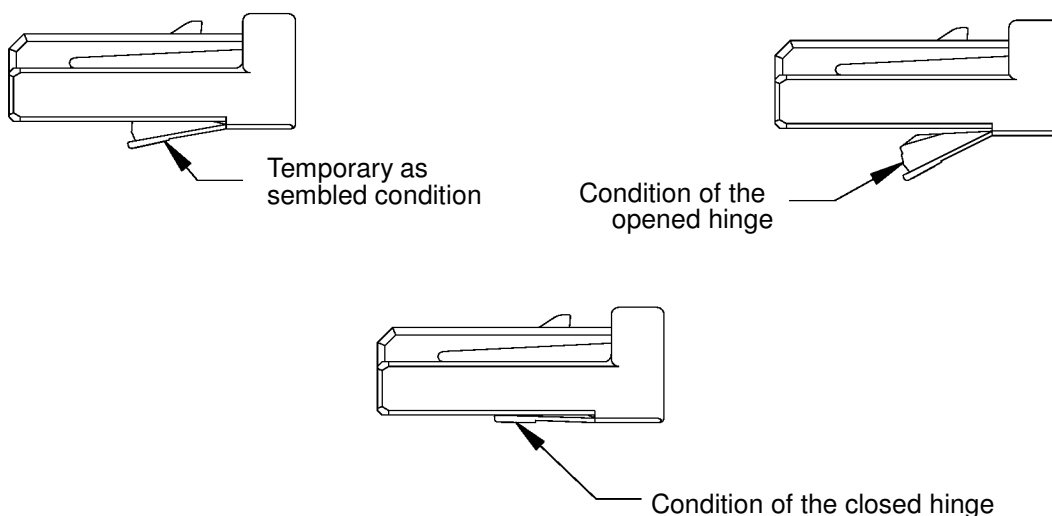

Fig. 12

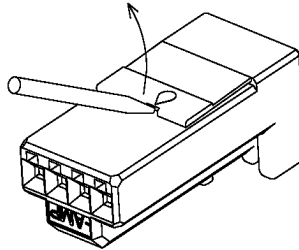

Fig. 13

7.2 Terminal attachment operation

Insert the terminals into the housing with same direction as shown in Fig.13. The insertion is finished when you hear click sound and the terminal stops.

By pulling the wire at 20N Max, check to make sure that the terminal can not be withdrawn.

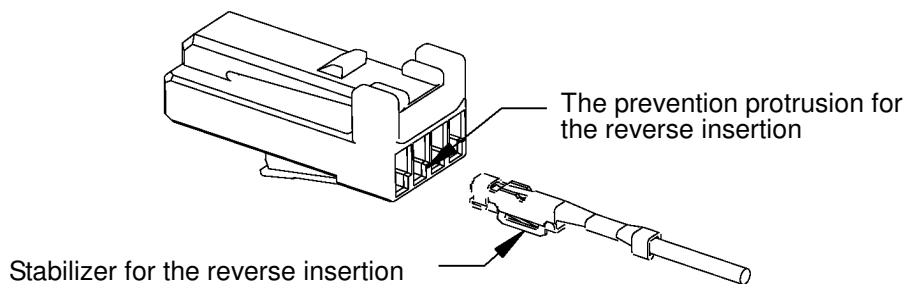

Fig. 14

NOTE Though The hinge part opens when the terminal inserts, this action is not a problem.

7.3 Double Lock (Secondary Lock) Operation

After insertion of all of the terminals, press the retainer for final lock condition. as shown Fig.14
The double lock operation is finished by confirmation that the retainer is kept in the final lock condition as shown Fig.14

When the retainer can not be pressed to the final lock condition, do not press by force, find the half inserted terminal and insert it to proper position Para .6.2

7.4 How to Unlock Retainer from Final Lock Condition

When the female terminal requires insertion or to extraction, the retainer must be in the pre-

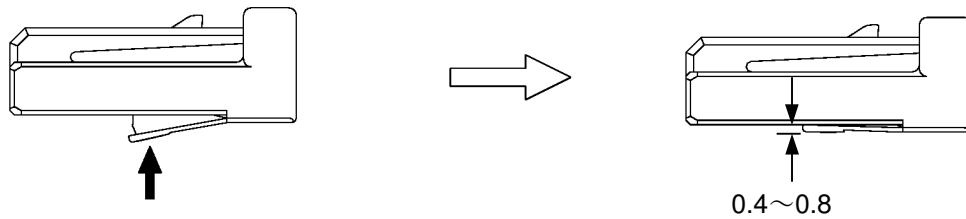

Fig. 15

assembled condition. The insertion or extraction can not be done in final lock condition. Using a driver such as 1 mm blade screw one, draw out the retainer to pre-assembled condition. Turn up hinge part is Fig.11 and make it temporary assembled condition or opened condition.

7.5 How to Extract Female Terminal

Confirm the retainer is in pre-assembled condition or opened condition in the case.

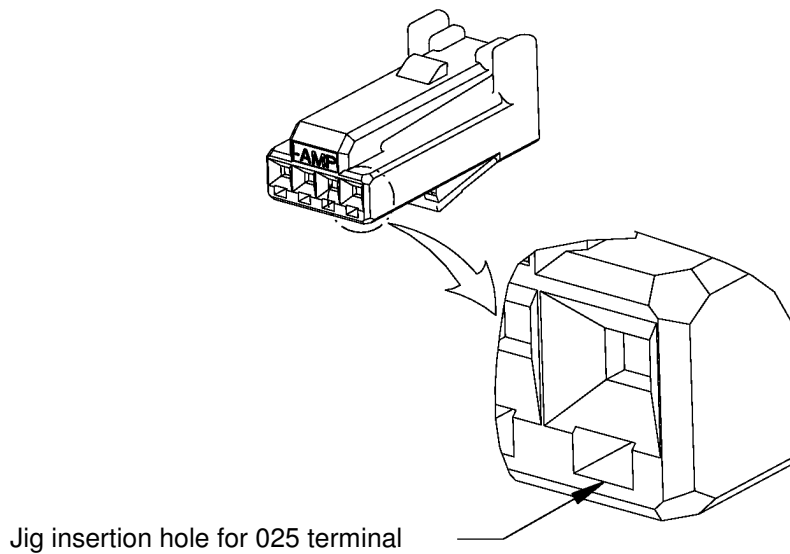

Fig. 16

Insert the jig into the hole as shown Fig.15. Confirm that the jig stops, pull out the terminal slowly. Insert the jig straight, do not press it by force.

Take care not to insert the driver into the female terminal. If the driver should be inserted, the female contact must be renewed.

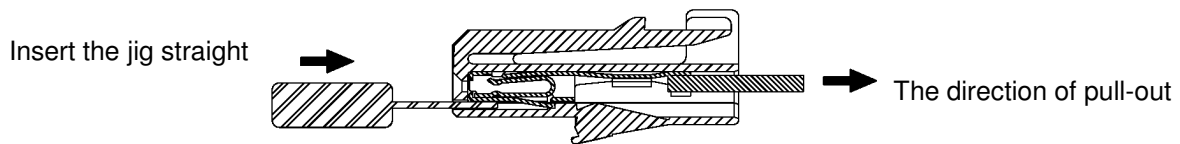

Fig. 17

NOTE

If only insert the jig, the contact lance will be released. Take care not to apply unnecessary force, otherwise the deformation of the jig occurs or it is cause for falling of retention force by the deformation of the contact lance. And do not repeat extract more than 10times, otherwise the retention force has fallen.
Do not extract the retainer by this extractive jig (for 025 contact).

7.6 Taping Up Wires

The wires must not be taped up more than 20mm from the end of housing to avoid applying unnecessary force to the wires.

7.7 Harness Control

7.7.1 Electric Circuit Check

- (1) For making a check on electric circuit, the applicable mating half or equivalent product should be used.
- (2) Never insert the probe pin for the inspection into the female terminal. The pin must be probed from the wire side.

7.7.2 Storage

Avoid storing the connector in a moist or dusty place. Stock the connector away from direct sunlight.

7.7.3 Shipping and Carrying

The connector should be used with the proper packing to prevent the ingress of dust or moisture , etc..

8.MATING AND EXTRACTION OF CONNECTOR

8.1 Mating of Connector

- (1) Check to make sure that the terminals are inserted into the housing improper condition, the wires are taped up from proper position and the retainer is in final lock condition. If the retainer is in pre-assembled condition, it must be changed to be in final lock condition.

- (2) And then check the terminal and the housing for defects, deformation, discoloration, damage, rust, crack, missing parts, etc..
- (3) Insert the proper female housing into the male housing. The operation is finished when you hear the click sound and can not insert further. when you can not insert the housing, do not insert by force and check the items in (1) and (2).
- (4) By pulling the female connector lightly, check to make sure that the connector can not be withdrawn.

8.2 Extraction of Connector

- (1) Grip the female housing and then draw straight out whilst pressing down the lock lever. When the housing can not be drawn out, do not pull it by force but check to make sure if the mechanism is released.

8.3 General Attention Matters

- (1) Do not mate and extract the connector unnecessarily.
- (2) Do not insert any objects expect the proper connector.
- (3) At mating/extraction operation, or after mating operation, take care not to apply unnecessary force shock to the wire and the connector.