



# Customer Manual

## XB Belt heater

----XB17 / XB19 / XB17C / XB19C

Operating manual No.  
Language:  
Rev:

409-35023  
English  
C





***RAYCHEM are trademarks of TE Connectivity.***

***All the information in this manual, including illustrations, is believed to be reliable. Users, however, should independently evaluate the suitability of each product for their application.***

***TE Connectivity /Raychem make no warranties as to the accuracy or completeness of the information and disclaim any liability regarding its use.***

***TE Connectivity/Raychem only obligations are those in the Standard Terms and Conditions of Sale for this product and in no case will TE Connectivity/Raychem are liable for any incidental, indirect or consequential damages arising from the sale, resale, use or misuse of the product.***

***TE Connectivity/Raychem Specifications are subject to change without notice. In addition, TE Connectivity reserve the right to make changes in materials or processing, without notification to Buyer, which do not affect compliance with any applicable specification.***

***No part of this manual may be reproduced or transmitted in any form or by any means, electronic or mechanical, including photocopying, or recorded by any information storage or retrieval system, without written permission from TE.***

***The original operating manual has been written in English.***

---

# Table of Contents

<b>1</b>	<b>Safety</b> .....	<b>4</b>
1.1	General Warnings .....	4
1.2	Electrical Safety.....	5
1.3	Safety Label .....	6
1.4	Preventing Damage to Machine.....	7
1.5	Servicing Safety .....	7
<b>2</b>	<b>Description</b> .....	<b>8</b>
2.1	General Information .....	8
2.2	XB17 / XB19 Specification .....	12
2.3	XB17C / XB19C Specification.....	13
<b>3</b>	<b>Installation</b> .....	<b>14</b>
3.1	Unpacking, Transport, Handling and Storage.....	14
3.2	Inspection (Power OFF) .....	14
3.3	Electrical Connections.....	14
3.3.1	220V/240V Input Power (Single phase, 220/240 V AC, 50/60 Hz) .....	15
3.3.2	115V Input Power (Single phase, 110 V AC, 50/60 Hz) .....	15
3.4	Air Connections.....	16
3.5	Inspection (Power ON) .....	16
<b>4</b>	<b>Operation</b> .....	<b>17</b>
4.1	Power ON and Warm-up.....	17
4.2	Loading and Unloading .....	18
4.2.1	Loading to XB Belt Heater .....	18
4.2.2	Loading to XB Belt Heater with optional Centering Device .....	19
4.3	Power OFF and cool down.....	21
<b>5</b>	<b>Software (HMI)</b> .....	<b>22</b>
5.1	Main Interface.....	22
5.2	Login On.....	24
5.3	Heat parameter .....	26
5.4	Production Counter .....	27
5.5	Maintenance.....	28



- 5.6 Calibration (Temperature) ..... 29
  - 5.6.1 Auto Calibration ..... 29
  - 5.6.2 Manual Calibration ..... 30
- 5.7 Remote Mode ..... 32
  - 5.7.1 Remote operation Procedure ..... 33
  - 5.7.2 RS232 Data Format ..... 34
- 5.8 System Parameter ..... 35
- 5.9 Barcode Scanning ..... 36
  - 5.9.1 Barcode Scanning mode ..... 36
  - 5.9.2 Code setting ..... 37
  - 5.9.3 Manual code input reading ..... 38
- 5.10 Error Log ..... 38
- 5.11 Data Collection ..... 39
  - 5.11.1 Data Collection - Local ..... 39
  - 5.11.2 Data Collection - Barcode ..... 39
- 5.12 Centering Manual ..... 40
- 6 Maintenance ..... 41
  - 6.1 Daily Maintenance ..... 41
  - 6.2 Weekly Maintenance ..... 42
  - 6.3 Monthly Maintenance ..... 43
- 7 Troubleshooting ..... 44
  - 7.1 Alarm Message ..... 45
  - 7.2 Troubleshooting Guide ..... 47
  - 7.3 Heater Test ..... 50
  - 7.4 Temperature Control Circuit Test ..... 50
    - 7.4.1 Thermocouple Check ..... 50
    - 7.4.2 Over temperature Circuit Test ..... 51
  - 7.5 Solid -State Relay Test ..... 52
  - 7.6 Drive Circuit Test ..... 53
    - 7.6.1 PLC drive Test ..... 53
    - 7.6.2 Stepper motor driver ..... 54
    - 7.6.3 Motor Resistance ..... 54
  - 7.7 Safety Relay Test ..... 55



- 7.8 DC Power Supply / Drive Fault Detector Circuit Test ..... 56
- 7.9 Optical Parts Counter ..... 57
- 8 Components and Repair .....58**
  - 8.1 Electrical cabinet ..... 59
  - 8.2 Key components replacement..... 60
    - 8.2.1 Belt Replacement ..... 60
    - 8.2.2 Heater Replacement..... 61
    - 8.2.3 Motor driver Replacement ..... 62
    - 8.2.4 Idler Pulley and Bearing Replacement ..... 62
    - 8.2.5 Drive Pulley Replacement ..... 62
    - 8.2.6 PLC or HMI replacement ..... 62
  - 8.3 Optional Accessories ..... 64
    - 8.3.1 Custom tooling (PN TBD) ..... 64
    - 8.3.2 Floorstand (TE PN: 2375329-1)..... 64
    - 8.3.3 Calibration tool..... 65
    - 8.3.4 Centering Device (TE PN: 2375330-1)..... 66
    - 8.3.5 Lockout gate (TE PN: 2375311-6)..... 68
    - 8.3.6 Other accessories ..... 68
  - 8.4 Spare Parts ..... 69
- 9 Address "After" Sales.....74
- 10 Schematic Diagram .....75
- 11 Pneumatic Diagram (Centering Device).....90
- 12 Declaration of conformity of CE.....91

# 1 Safety

In common with all electrical equipment, the XB belt heater must be used in accordance with established safe working practices.

Prior to using the equipment, carefully read the Installation and Operation (Section 3 & 4), together with the following safety warnings.



## **First Aid Instructions**

*In the event of injury from electrical shock or burns the victim should seek immediate medical assistance from qualified medical personal.*



## **Fire and Shock Hazard**

*As with all electrical equipment, the XB17 / XB19 Belt heater must be set up and operated properly, according to the procedures detailed in this manual.*

*Carefully read and observe the instructions and warnings for setup, operation, maintenance, troubleshooting, and repair.*

Cotton gloves are recommended for operating the machine and for uploading finished harnesses. Touching hot adhesives, hot splices, or heaters can cause burns. Prior to performing maintenance or repair, always turn OFF the I/O button, allow the machine to cool down, and then turn OFF the MAIN SWITCH and unplug the machine. Opening the electrical cabinet while the machine is powered may cause electrical shock.

Operate the machine with all covers and panels in place. If hands, hair, clothing, or any other foreign objects are caught by the machine's moving parts, you could get injured and the machine could be damaged.

Always provide adequate ventilation and avoid overheating the product or components during processing. Charring or burning of the tubing or wire insulation will produce fumes that may cause eye, skin, nose, or throat irritation.

## 1.1 General Warnings



- ❖ *Incorrect use of this machine may cause injury.*
- ❖ *This machine must be operated and maintained only by fully trained and qualified personnel. Operation should be according to this manual, to avoid getting hurt.*
- ❖ *Do not leave the machine unattended during the process cycle.*
- ❖ *Opening the machine cover while the machine is power ON may cause electrical shock. Always press the E-STOP button, turn OFF the Main Switch, and unplug the machine prior to any electrical maintenance or repair.*
- ❖ *In case of excessive smoke, sparks, grinding noises, or any other signs of malfunction, press the emergency stop button, then open the top chamber and remove any assemblies that may be in the heating chamber. Contact maintenance personnel to investigate the cause of the emergency before restarting the machine.*
- ❖ *Failure to follow the manufacturer's instructions may affect the machine warranty.*

- ❖ **Do not use the equipment for cooking food or heating products other than those recommended by TE Connectivity, especially avoid those products may release hazardous gas after heating.**
- ❖ **Due to the machine can reach up to 600°C, do not operate the Equipment near flammable and combustible environment.**
- ❖ **Do not disassemble the equipment without guide or permission from TE.**
- ❖ **Ensure adequate ventilation around the cooling fan intake and output grills a minimum of 75mm clear space, when the equipment is in use.**

## 1.2 Electrical Safety



The equipment is connected to an AC mains electricity supply. Before undertaking any maintenance or repair, always turn off the equipment and ensure it is isolated from the AC supply.



- ❖ **DO NOT CARRY OUT AN INSULATION RESISTANCE CHECK USING A PORTABLE APPLIANCE TEST UNIT AS THIS WILL RESULT IN DAMAGE TO THE EQUIPMENT.**
- ❖ **High voltage TESTING - Do NOT do the Test without the authorization of TE (protection circuits fitted to this equipment may be damaged...)**
- ❖ **INSULATION RESISTANCE TESTING - Do NOT exceed 250V DC (protection circuits fitted to this equipment may be damaged).**
- ❖ **Power connections for the Processor must conform to local standards and regulations.**
- ❖ **Potentially hazardous voltages will be exposed if the equipment's panels are removed while it is powered-up. Do not use the equipment unless all external panels are securely in place.**
- ❖ **The equipment input supply has double pole fusing (Line & Neutral) and must be connected to an earthed power supply.**
- ❖ **Use only specified fuse types and ratings.**
- ❖ **Terminal customer should install overcurrent protective device. (20A)**
- ❖ **Terminal customer should apply the power with overvoltage and undervoltage protection.**

### 1.3 Safety Label



*Read the Customer Manual before operation.*



*Eye protection must be worn at all times when the tool is in use.*



*Care must be taken to ensure the warning description is completed understand and follow.*



*It is recommended that protective clothing and gloves are used when operating this machine.*



*Do not touch the machine heating chamber - during use, it will become extremely hot.*

*Special care must be taken when product or calibration probe ejection from the heating chamber.*



*Do not try to put hands in, it could cause crush.*

*If hands, hair, clothing, or any other foreign objects are caught by the machine's moving parts, press on emergency button on machine top, and catch and lift the handle to open top chamber to remove anything.*



*High Voltage. Should take care, avoiding personal injury from electrical hazard.*



## 1.4 Preventing Damage to Machine

To prolong belt life, machine program to not allow setting the belt speed to less than 2.5mm/s. When the belt speed below 2.5mm/s will activate the drive fault alarm and initiate cool down mode.

For normal maintenance and repair, press the I/O button and allow the machine to cool before turning OFF the Main Switch. When the machine cools and the belts and fans stop running, turn OFF the Main Switch and unplug the machine. Do not attempt to bypass turn OFF the Main Switch.



***XB Belt Heater working temperature is 600 °C max. Do not set the temperature above 600 °C. That will cause heat damage to the components of the machine and shorten the life of the heaters.***

Do not cover the fan louvres. Covering the louvres by setting objects on or next to them may cause uneven heating or overheating of components.

An exposed thermocouple wire due to abrasion of the insulation will cause an over temperature condition that can destroy components of the machine and cause inconsistent processing of assemblies. When replacing the covers, ensure that no wires get trapped between the cover and the frame.

Tight belts put excessive side loading on the bearings and can cause premature bearing wear and uneven belt stretch. To adjust the tension in the belts, follow the steps out lined in Section 6.2, Belt Tension Adjustment.

Emergency Stop: In case of excessive smoke, sparks, grinding noises, or any other signs of malfunction, press the emergency stop button. Then open the top chamber and immediately remove any assemblies that may be in the heating chamber. Contact maintenance personnel to investigate the cause of the problem before restarting the machine.



***Such malfunctions are the only reasons to press the emergency stop button while the belts and fans are still running. DO NOT use this as the normal shutdown procedure because it will defeat the cool-down circuit. And that would reduce the life of Machine.***

## 1.5 Servicing Safety

When carrying out repairs, always follow the instructions contained in this manual or contact TE Connectivity for further advice. A record should be kept of the maintenance and servicing of the equipment.

Do not use substitute components, use only TE Connectivity approved parts. If the mains (utility) power supply cord is damaged it must be replaced only by a special cord or assembly available from the supplier or its agent.

## 2 Description

This manual applies to:

- ✚ **XB17 Belt heater, STD** (TE PN: 2375310-1)  
----XB17 Standard machine
- ✚ **XB17 Belt heater, 110V** (TE PN: 2375310-2)  
----XB17 110V heater version
- ✚ **XB19 Belt heater, STD** (TE PN: 2375320-1)  
----XB19 Standard machine
- ✚ **XB19 Belt heater, 6" version** (TE PN: 2375320-2)  
----XB19 wider heater version.
- ✚ **XB17C Belt heater** (TE PN: 2381120-1)  
----XB17 Standard machine with Centering Device
- ✚ **XB19C Belt heater** (TE PN: 2381130-1)  
----XB19 Standard machine with Centering Device



- Part Number of XB17C (PN: 2381120-1) and XB19C (PN: 2381130-1) is not sellable. Customer can purchase optional Centering Device (PN: 2375330-1) separately and install it onto XB17 or XB19, then convert to XB17C or XB19C.
- XB19 Standard version (TE PN: 2375320-1) can be converted to Wide version (TE PN: 2375320-2), with heater width changed up to 150mm and some other reference parts to be replaced. This is a semi-permanent conversion, not a daily free adjustment. This conversion is a chargeable service by TE FE team. Not recommended to do by customer personnel.

### 2.1 General Information

The XB belt heater is a low-maintenance, high-production heater that recovers Raychem heat-shrinkable tubing onto wire harness assemblies or other suitable substrates. End terminations and ring terminals can be processed with customized tooling.

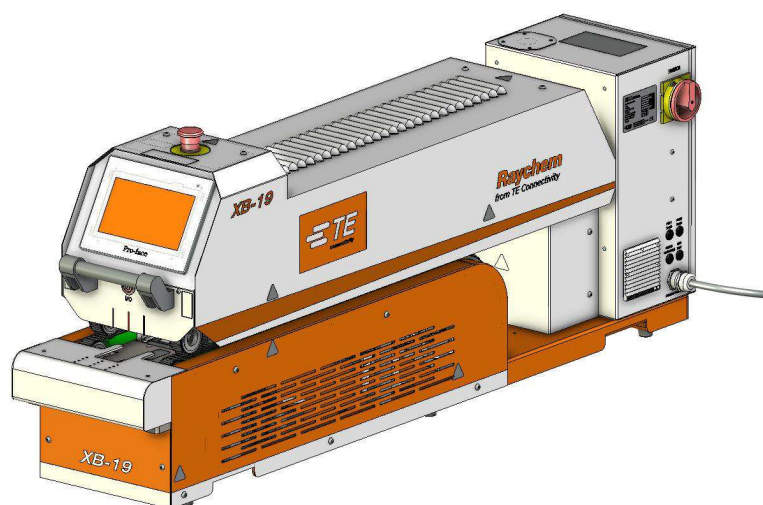

Fig.1 General View



*Users should independently evaluate the suitability of this equipment for satisfactorily installing tubing to meet their requirements. It is also the users' responsibility to maintain and adjust the equipment, monitor the process, and inspect the installed product to ensure that process requirements are met on an ongoing basis.*

*Throughout the manual photographs refer to the standard version of the XB19 belt heater. And may not accurately reflect the other version. However where possible supplemental photographs have been added. If additional information is required contact TE.*

On the standard XB belt heater, assemblies are continuously loaded at one end between two sets of double-sided timing belts. These timing belts grip and carry the assemblies through a heating zone, cooling zone, and then deposit them into a collection bin located at the end of the drive belts, where the assemblies can be removed individually or in batches, with virtually no process time delay. Allowing for a few seconds of cool down, the assemblies can be removed almost as quickly as they are fed in. Process speed control and heater temperature set point are both closed loop systems and can be controlled within a wide range of time and temperature combinations as needed for specific applications. See section 4.2 for more detail.

The XB belt heater is a tabletop machine that can run continuously with only interim routine maintenance and cleaning.

For assistance, contact your local TE representative.

To achieve proper machine cooling after use, after the I/O push-button is pressed heaters will power off and the fans and belts continue running for approximately 20 minutes. When 20 minutes time up, the fans and belts stop automatically. This cool down cycle prevents heat damage to the belts, belt guides, and other components.

The XB belt heater has several safety features and self-diagnostic circuitry designed to protect the operator, machine, and product. If any one of the alarms is activated, a warning light located on the front control panel will illuminate, power to the heaters will shut off, and the timing belts will move forward (lockout gate will rise, if optional lockout gate is chosen) preventing feeding assemblies and the unit will enter cool down mode.

Once the fault is cleared, press and hold the I/O button for 5 second to start the device. Heating parameter (timing belt speed & heaters temperature) will resume previous setting. When temperature reach setting range, timing belt will move backward (lockout gate will fail, if lockout gate is chosen), then machine is ready for cycle.

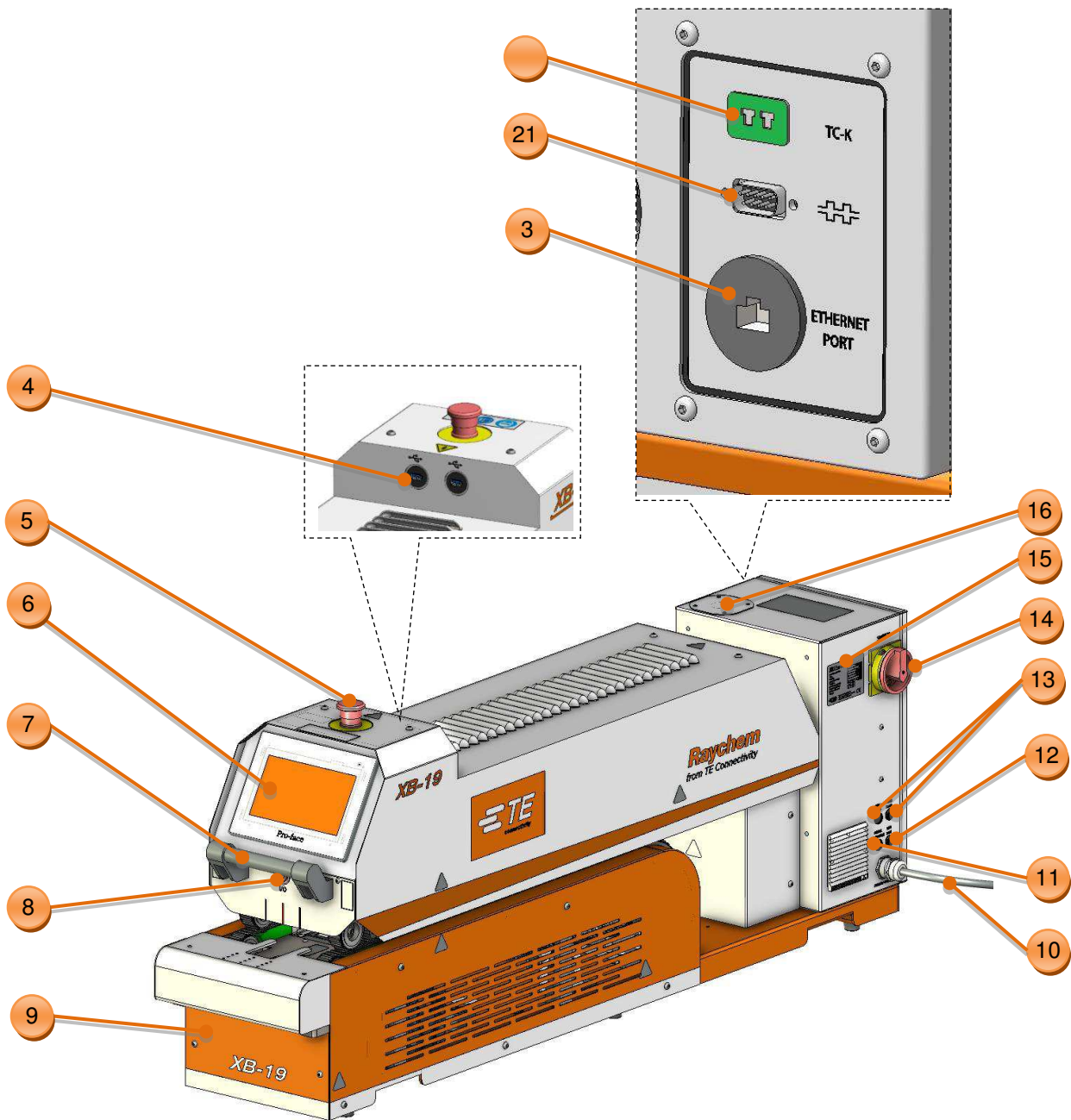

Fig.2 Operation and Interface (XB17 & XB19)

1. Calibration Socket  
(Connect to the UHI temperature probe, to access auto-calibration process.)
2. Remote interface  
(RS 232 connector, originally designed to connect to external device, Refer to section 5.7)
3. Ethernet Port  
(Connect with PC, to upgrade program to PLC and Touch Panel. If no PC available, operator can also upgrade PLC by micro SD card insert to PLC module in electrical cabinet, upgrade Touch Panel via item 4 USB port.)

4. **USB Port**  
*(XB belt heater have 2X USB port. Allow to upgrade Touch Panel locally vis these 2X USB port, or connect with barcode scanner, or for data collection.)*
5. **Emergency Stop**  
*(Cuts power to machine in Emergency)*
6. **Touch Panel**  
*(Display machine working information. Can edit machine parameter after login on.)*
7. **Lift Handle**  
*(Catch the handle to lift the top chamber to remove splice in Emergency or when doing maintenance.)*
8. **I/O Button**  
*(Press and hold for 5 second to activate or inactivate heater power.  
Off--standby, Flash—warm up, Lit—temperature reach set value)*
9. **CD cover**  
*(remove this cover to show the connection interface with Centering Device.)*
10. **Power Inlet (Power supply)**
  - *XB17 2375310-1, 230V AC*
  - *XB17 2375310-2, 115V AC*
  - *XB19 2375320-1, 230V AC*
  - *XB19 2375320-2, 230V AC*
11. **Heater Fuse (FS3)**
  - *XB17 2375310-1, 1X 230V, 12A anti-surg*
  - *XB17 2375310-2, 1X 115V, 20A anti-surg*
  - *XB19 2375320-1, 1X 230V, 20A anti-surg*
  - *XB19 2375320-2, 1X 230V, 20A anti-surg*
12. **Fan Fuse (FS4)**  
*(24V DC, 2A anti-surge)*
13. **Main Power Fuse (FS1 & FS2)**
  - *XB17 2375310-1, 2X 230V, 15A anti-surg*
  - *XB17 2375310-2, 2X 115V, 20A anti-surg*
  - *XB19 2375320-1, 2X 230V, 20A anti-surg*
  - *XB19 2375320-2, 2X 230V, 20A anti-surg*
14. **Main Switch**  
*(Used to isolate external power)*
15. **Nameplate**
16. **Light tower hole**  
*(A reserved hole to mount optional light tower if need.)*

## 2.2 XB17 / XB19 Specification

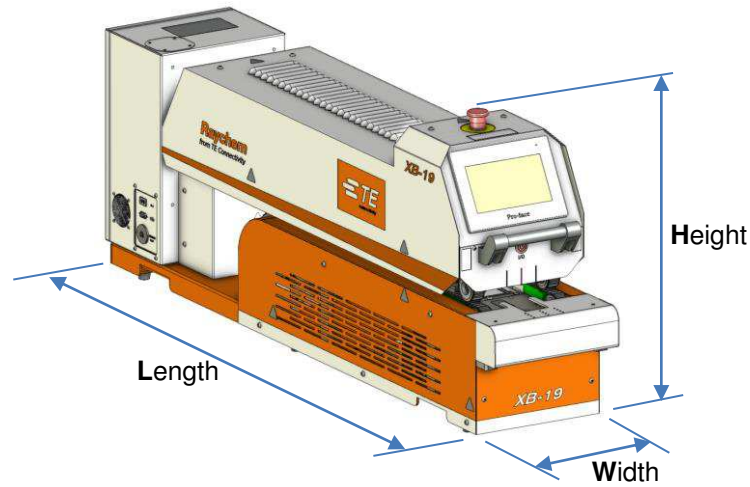

Fig.3 Belt Heater (XB17 & XB19)

**Table 1 – General Machine Parameters (Machine)**

Model Designation	XB-17		XB-19	
	TE PN: 2375310-1 220V version	TE PN: 2375310-2 110V version	TE PN: 2375320-1 3.75" version	TE PN: 2375320-2 6" version
<b>Power supply</b>	230 (+/-10%) V AC 50/60 (+/-1) Hz	115 (+/-10%) V AC 50/60 (+/-1) Hz	230 (+/-10%) V AC 50/60 (+/-1) Hz	230 (+/-10%) V AC 50/60 (+/-1) Hz
<b>Air supply</b>	N/A			
<b>Heater</b> <i>(upper &amp; lower)</i>	W 100 x L 250 (mm) 1000 Watt each	W 100 x L 250 (mm) 1000 Watt each	W 95 x L 360 (mm) 1580 Watt each	W 150 x L 360 (mm) 1660 Watt each
<b>Machine size</b>	W 260 x L1210 x H 510 (mm)		W 260 x L1340 x H 550 (mm)	
<b>Max. Tubing Size</b>	19 Dia x 90 L (mm)		25 Dia x 100 L (mm)	25 Dia x 160 L (mm)
<b>Min cable length</b> <i>Excluding length to catch by hands</i>	190 mm		180 mm	235 mm
<b>Working temp</b>	600 °C max			
<b>Ambient operating Environment</b>	Temperature: 5 to 40 °C Relative humidity: 50%~90%			
<b>Belt speed Adjustment</b>	2.5~42 mm/sec; 0.1 mm/sec increment			
<b>Noise</b>	80dB Max (Cyclic, 1m from machine)			
<b>Net Weight</b>	72 KG		77 KG	

### 2.3 XB17C / XB19C Specification

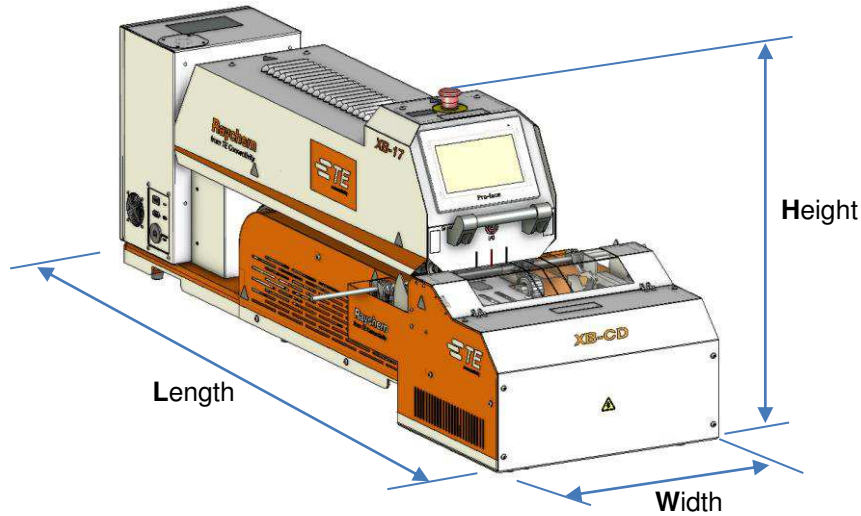

Fig.4 Belt Heater with Centering Device

Table 2 – General Machine Parameters (Machine with CD)

Model Designation	XB-17C	XB-19C
	TE PN: 2381120-1	TE PN: 2381130-1
<b>Power supply</b>	230 (+/-10%) V AC 50/60 (+/-1) Hz	
<b>Air supply</b>	4~6 bar	
<b>Heater</b> <i>(upper &amp; lower)</i>	W 100 x L 250 (mm) 1000 Watt each	W 95 x L 360 (mm) 1580 Watt each
<b>Machine size</b>	W 450 x L 1570 x H 510 (mm)	W 450 x L 1700 x H 550 (mm)
<b>Max. Tubing Size</b>	19 Dia x 90 L (mm)	25 Dia x 100 L (mm)
<b>Min cable length</b> <i>Excluding length to catch by hands</i>	450 mm	
<b>Working temp</b>	600 °C max	
<b>Ambient operating Environment</b>	Temperature: 5 to 40 °C Relative humidity: 50%~90%	
<b>Timing Belt speed Adjustment</b>	2.5~42 mm/sec; 0.1 mm/sec increment	
<b>Noise</b>	80dB Max (Cyclic, 1m from machine)	
<b>Net Weight</b>	96 KG	101 KG

## 3 Installation

### 3.1 Unpacking, Transport, Handling and Storage

The XB19 Belt Heater has a mass of 86 Kg (XB17 have 81 Kg). When unpacking, transporting, handling or moving the unit to storage, it is recommended that no less than two persons or a lift truck be used for the process. When storing the unit, it should be placed in a suitable crate, and stored indoors away from any harmful effects of weather or other hazards.

Remove the machine from its shipping container and check for damage. Inspect the shipping container and machine for any evidence of damage during shipment. If you believe there has been damage, contact the shipping agent immediately.

Set the machine on a flat, level surface. Choose a work area with enough room around the machine for loading and unloading wire harnesses. Also allow room for routine maintenance and repair.

Provide adequate ventilation. Allow enough clearance above and around the machine so that the fans can circulate cooling air without obstruction. Do not place anything on the top chamber or cover the fan louvres.

Open TOP CHAMBER and remove packing material between the heaters. Packing material has been placed between the heaters to prevent vibration damage during shipment. Power ON before remove the packing material could get burning.

### 3.2 Inspection (Power OFF)

At the completion of the unpacking sequence, follow these steps to inspect the machine before making any electrical connections. If you believe damage may have been caused during shipping, contact the shipping agent immediately.

Check the alignment. When the upper heating chamber is closed, the upper belts should be aligned with the lower belts along their entire length with no more than a 6 mm offset. If the belts are not aligned contact your local Raychem representative.

Inspect the heaters for damage. Visually check the heaters for evidence of cracking or chipping of the glass face during shipment. The heaters should be fastened firmly into the baffles.

Ensure that all cover panels are in place and secure. All secure screws are in place.

### 3.3 Electrical Connections

Improper electrical connections will result in damage to the machine. Ensure that proper electrical connections are made before energizing.

#### **DANGER!**



Machine is shipped with a 3 meters power cord, without plug. Electrical connections should be carried out only by a qualified electrician.

- ❖ Refer to the electrical schematic in the back of this manual for proper connections. Measure the incoming voltage! Do not assume the rated voltage is nominal.



### 3.3.1 220V/240V Input Power (Single phase, 220/240 V AC, 50/60 Hz)

Connect the power cord to the machine using the following connections:

Brown = L (circuit breaker)

Blue = N (circuit breaker)

Green/Yellow = PE (protective earth ground)



<b>XB17 Belt heater, STD</b>	<b>(TE PN: 2375310-1)</b>
<b>XB19 Belt heater, STD</b>	<b>(TE PN: 2375320-1)</b>
<b>XB19 Belt heater, 6" version</b>	<b>(TE PN: 2375320-2)</b>
<b>XB17C Belt heater</b>	<b>(TE PN: 2381120-1)</b>
<b>XB19C Belt heater</b>	<b>(TE PN: 2381130-1)</b>

### 3.3.2 115V Input Power (Single phase, 110 V AC, 50/60 Hz)

Connect the power cord to the machine using the following connections:

Brown = L (circuit breaker)

Blue = N (circuit breaker)

Green/Yellow = PE (protective earth ground)



<b>XB17 Belt heater, 110V</b>	<b>(TE PN: 2375310-2)</b>
-------------------------------	---------------------------

### 3.4 Air Connections

Air connection is need only when optional Centering Device is available.



**Pressure air: 4~6 bar**  
**Outer diameter of pipe: 10mm**

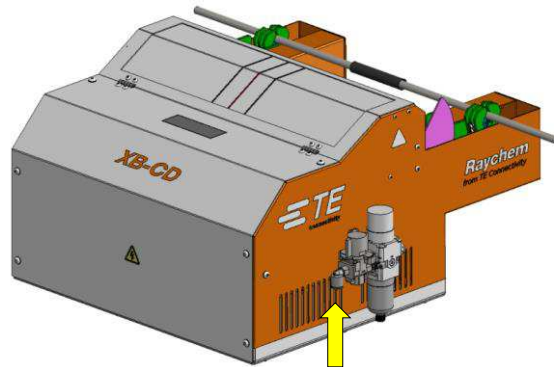

*Fig.5 Air connections*

### 3.5 Inspection (Power ON)

At the completion of the power OFF inspection sequence and the electrical connections, follow these steps to complete the set up and inspection of the machine.

Power ON the machine according to section 4.1 Power ON and Warm-up.

In touch panel, select the preset heating parameter which stored in touch panel (see Fig.12, item 2 process number), to check if machine will change the temperature and belt speed accordingly.



Using the emergency stop or Main Switch as the normally shut down procedure defeats the automatic cool down circuit and will cause heat damage to the machine

## 4 Operation

### 4.1 Power ON and Warm-up

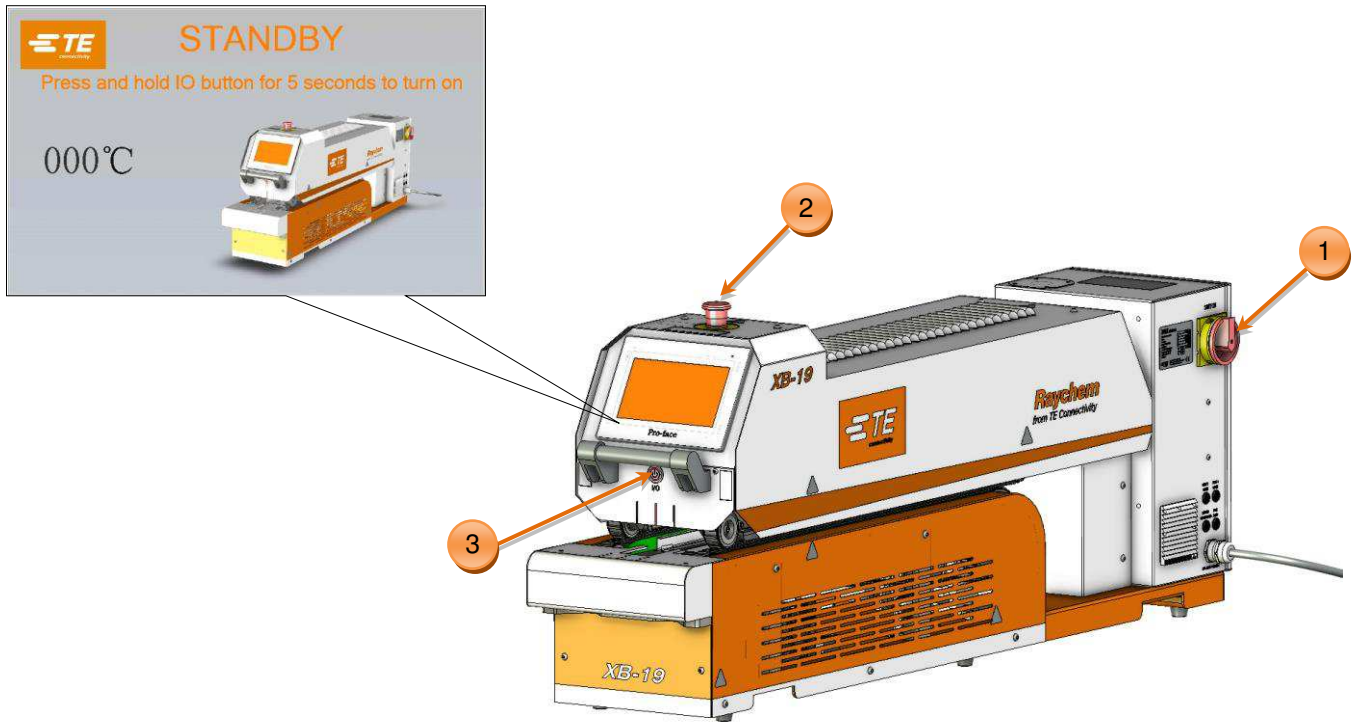

Fig.6 Power ON

Verify that the machine is connected to the appropriate power source. Refer to section 3.3 Electrical Connections, about how to connect to appropriate power source.

#### Power ON:

1. Turn on the Main Switch
2. Rotate E-stop button clockwise to release E-stop button.
  - Touch panel will entry standby mode. See the top left picture in Fig.6 .
3. Press the I/O button for 5 second.
  - Machine will turn ON power to heater.
  - I/O button start to flash.
  - Touch panel entry main interface.
  - In touch panel the heater actual temperature starts to rise from ambient.
  - Timing belt start to move forward (lockout gate rise).
4. When temperature reach 200°C, machine cooling fans will start working.
5. When temperature reach preset temperature range, machine is ready for production.
  - Heater indicator on main interface will show green.
  - I/O button lit.
  - Timing belt change to move backward (lockout gate fall).



When the heaters have reached the set temperature, wait approximately 5 minutes for the heater temperature to stabilize before production.

## 4.2 Loading and Unloading

At the completion of the power ON and warm-up sequence, follow these steps to process wire assemblies. These instructions are for processing center splices. For other applications contact your local Raychem representative.

### 4.2.1 Loading to XB Belt Heater

1. Select the suitable process number according to the tube type.
2. Prepare the wire assembly. Slide a piece of Raychem heat-shrink tubing over the assembly, next to the splice to be sealed.

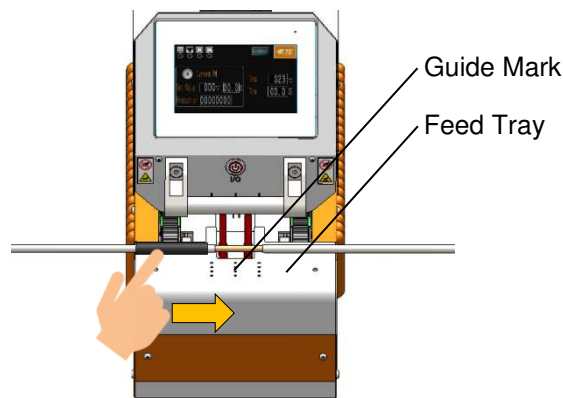

Fig.7 Centering the Splice & Tube

3. Center the nugget on the feed tray. Use the center guide mark to align the nugget of the splice.

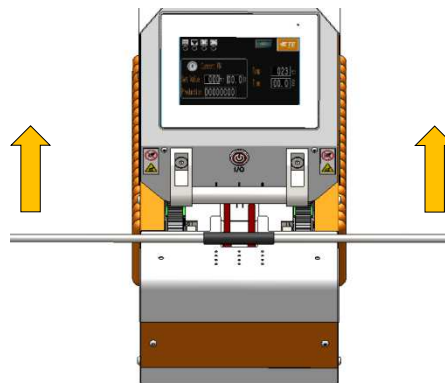

Fig.8 Feed into heating chamber

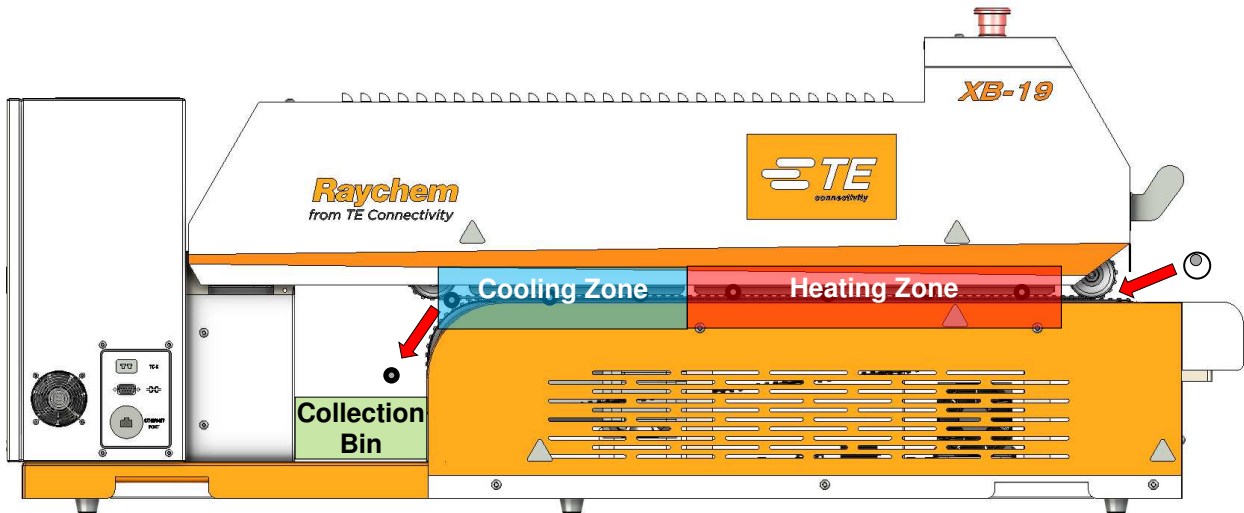

Fig.9 Machine Workflow

4. Center the tubing over the nugget, using the outboard alignment marks on the feed tray.



*For significantly unbalanced splices, offsetting the tubing toward the larger side is helpful to prevent 'milk-off' of the tubing*

5. Slide the assembly into the belts. The timing belts grip the assembly and pull it into the heating chamber, going through heating zone, cooling zone, and then deposit the finished assembly into the collection bin.



*Allow the assemblies to cool for a few seconds after they fall to the collection bin.*

#### 4.2.2 Loading to XB Belt Heater with optional Centering Device

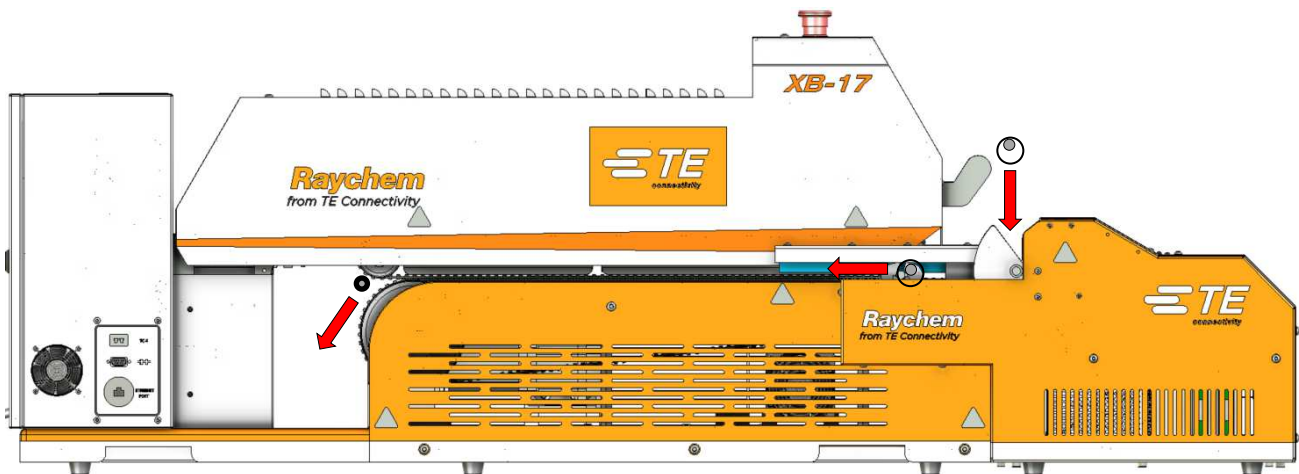

Fig.10 Machine with CD Workflow

1. Select the suitable process number according to the tube type.
2. If need, adjust the detection probes distance, or offset for Centering Device detection unit.
3. Prepare the wire assembly. Slide a piece of Raychem heat-shrink tubing over the assembly, next to the splice to be sealed.
4. Carry both end of cable and push cable down, allow splice contact with both detection probes. When splice contact with both detection probes successfully, clamping cylinders will clamp on both ends of cable automatically, then feed to machine heating chamber automatically.
5. When clamping cylinder back to home position, Centering Device is ready for next cycle.



*Be careful when feed cable into Centering Device. When detection probes contact with splice successfully, clamping cylinders will clamp on both ends of cable automatically. **Keep hands out of Centering Device to avoid crushing.***

### 4.3 Power OFF and cool down

At the end of the work shift, press the I/O button for 5 second. This will shut off power to the heaters. The belts and the fans will continue to run for 20 minutes, until a cool safe temperature has been reached, at which time all power will shut off automatically.

#### Power OFF:

1. Checking on timing belt, no wire assembly remain on timing belt.
2. Press and hold the I/O button for 5 seconds.
  - Machine will entry cooling down process. It will take about 20 minutes to cool down.
  - Heater will power off
  - Timing belt moving forward (lock out gate rise)
3. When temperature fall below 200°C, machine cooling fans and timing belt will stop. Touch panel will show the machine is in standby mode.
4. Turn OFF Main Switch.



Fig.11 Shutdown Interface



*Do not use the Main Switch or Emergency stop for the normal shutdown procedure. This defeats the automatic cool down cycle and will cause heat damage to the machine.*

## 5 Software (HMI)

The software serves as the machine's central control unit. With this you can set the procedures for product processing. The software is operated via a touch panel.

### 5.1 Main Interface

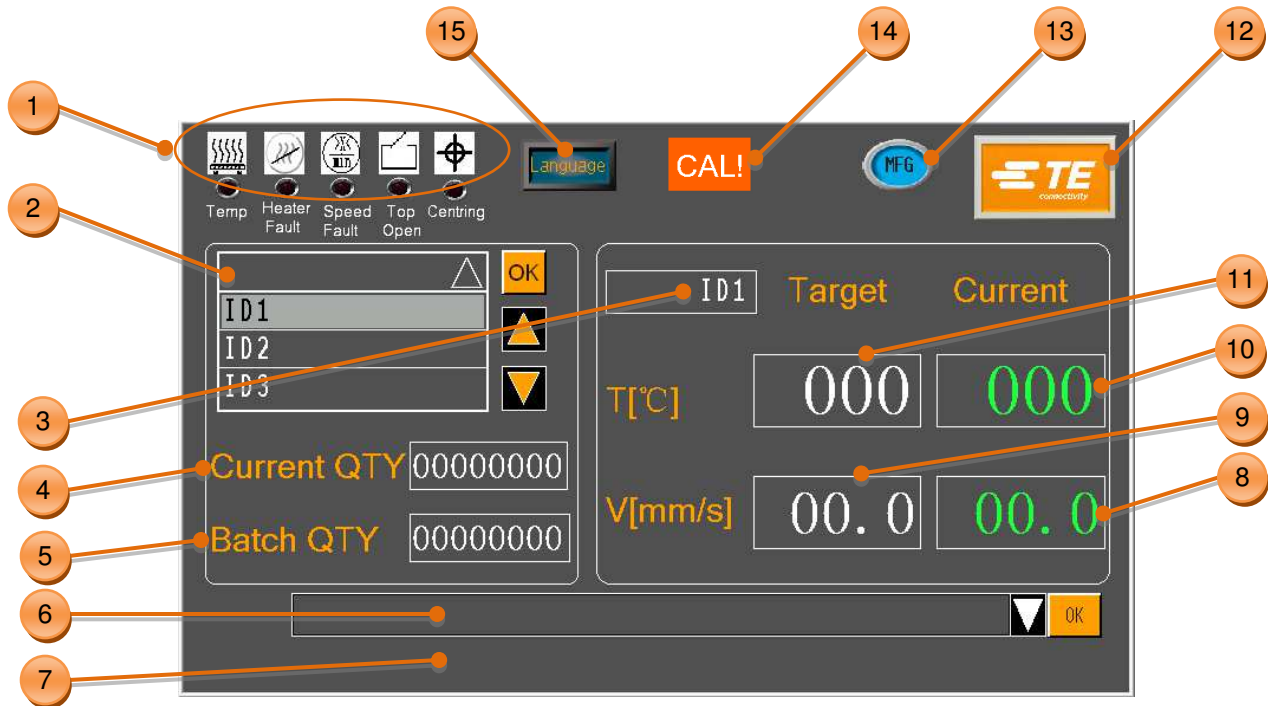







Fig.12 Main Interface

#### 1. Status Indicators

(5 indicators on the touch panel indicate the status of the machine. These indicators include equipment status indicators and many alarm condition indicators.)

- 
 • **TEMP:** Indicator to show heater status.  
*Yellow, when warming up.*  
*Red, when temperature exceeds the set value by 20 °C.*  
*Green, when reach preset temperature range.*
- 
 • **HEATER FAULT:** Indicator illuminate only when Heating failure.
- 
 • **SPEED FAULT:** Indicator illuminate when motor position out of tolerance, or speed error.
- 
 • **TOP OPEN:** Indicator illuminate when top chamber open.
- 
 • **Centering:** This icon will show only when Centering Device is activated. Section 8.3.4 Centering Device.



2. **Process No.**  
*Operator can select the process number from this column, with help of up and low arrow to flip over, then click on OK to load heat parameter (PN / temperature / belt speed) stored in the selected process number to machine.*  
*Operator can also click on blank area, then we can get a quick input windows, input key words and search the process number.*  
*Refer to section 5.3 Heat parameter, about how to new add or edit the heat parameter stored in the 10 process numbers.*
3. **Current PN**  
*Description for operator, on identifying the product or process No. Operator can edit as product name or PN. See section 5.3 Heat parameter, about how to edit it.*
4. **Current QTY**  
*It shows the real-time production quantity. Operator can reset the value in Production Setting page manually. In case the Batch QTY was activated, this value will reset automatically when Current QTY meet Batch QTY.*
5. **Batch QTY**  
*It shows the target production quantity. Operator can preset this value in Production Setting page before production. When Current QTY meet this value, in the Maintenance will pop up message to remind operator. Operators need to close this window to clean the message. Default value is 0, which means it will turn OFF the reminder.*
6. **Setting Item**  
*Access to advanced setting page. Login on by click on TE logo, the Setting Item column will show. Click on the column to find the dropdown list, to select the different setting item. Refer to section 5.2 Login On)*
7. **Error message area**  
*In case of error appear, error message will roll in this area continuously until operator solve the problem. For example, if operator open the top chamber, an error message will roll until operator close the top chamber. Try to wait second for error message to run through the window after problem was solved.*
8. **Current speed**  
*Real-time speed for the timing belt.*
9. **Target speed**  
*Target timing belt speed value stored in the selected process No.*
10. **Current Temp**  
*Real-time temperature of heater.*
11. **Target Temp**  
*Target temperature value stored in the selected process No.*
12. **Login button**  
*TE logo, click on this button to login on.*
13. **Current ID**  
*When operator login on, this icon will show the current login ID.*
14. **Cal reminding**  
*Machines have default count down for calibration requirement. When this message appeared, try to operate calibration as soon as possible. So as to make sure machine operate at good heating capacity.*
15. **Language button**  
*It will show the current language. Click on this icon to select other language.*

## 5.2 Login On

Access to advanced page, to review more detail on machine status or try to edit machine parameter (like heat parameter), it will require operator to login on. Follow below steps to login on:

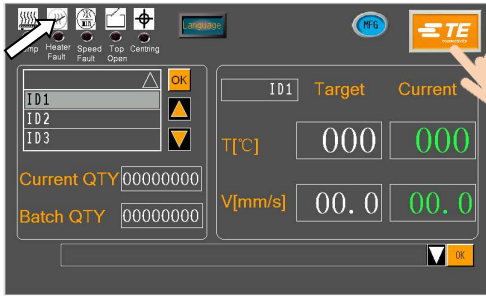

When power ON to machine, you would see the main interface like the picture left. Press on the TE logo from the main interface to login on. 3 level authority to log on:

- “OPR” ---- user ID: “A”, password: “0000”
  - “EGR” ---- user ID: “B”, password: “12345”
  - “MFG” ---- user ID: “C”, password: (TE kept)
- (password can be edit by higher authority.)



After TE logo is click, a window pops up like picture left. Input ID and password in this window.

For example, we are trying to log on as Engineer, then we should input “B” in user ID column, and input “12345” in Password column.

Then click on “OK” button.

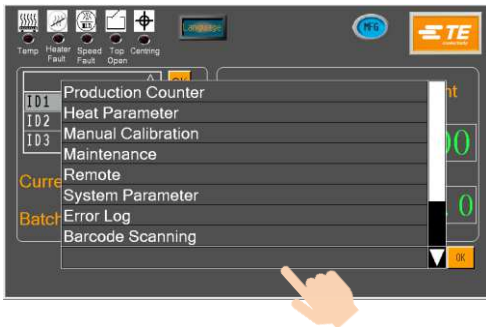

You would find the main interface already have 2 changes:

1.  ID icon is showing you access as engineer.
2. On the bottom appear a column. Click on it, would appear a drop-down list.
3. In this drop-down list, you can choose the setting item, like show on below table.

**Table 3 – Setting item**

Access right for setting item	No Log on	OPR	EGR	MFG
Production Counter	-	✓	✓	✓
Auto Calibration	✓	✓	✓	✓
Heat parameter	-	-	✓	✓
Manual Calibration	-	-	✓	✓
Maintenance	-	-	✓	✓
Remote	-	✓	✓	✓
System Parameter	-	-	-	✓
Error Log	-	-	✓	✓
Barcode Scanning	-	-	✓	✓
Data collection-Local	-	-	✓	✓
Data collection-Barcode	-	-	✓	✓
Centering Manual	-	-	✓	✓

### 5.3 Heat parameter

Originally machine was programmed to store 10 process numbers (ID1, ID2...ID10 default, up to ID1000 max), each process number will store heat parameter (Product name / Temperature / Speed). Customer can new-add or edit process number in this page if need.

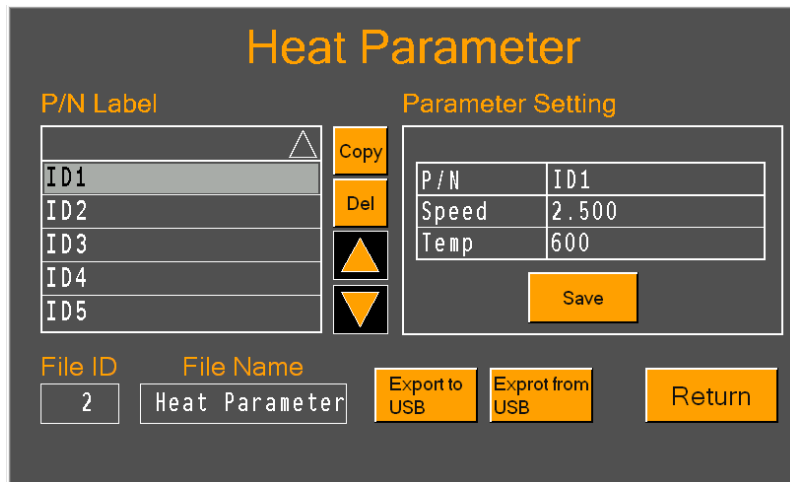

Fig.13 Heating parameter page

**Edit exist process number:** (take ID1 for example)

1. Click on ID1 from the **P/N Label table** on page left. Then we can see the heat parameter (Part number / Speed / Temperature) stored in ID1, will show on the **Parameter Setting** table.
2. Click on the value to be edit in **Parameter Setting** table, to input the new value.
3. Click on Press on the **SAVE** button, to upload new parameter to ID1.

**New add process number:**

1. Click on ID1 (or any other process number) from the **P/N Label** table on page left. Then we can see the heat parameter (Part number / Speed / Temperature) stored in ID1, will show on the **Parameter Setting** table.
2. Click on **COPY** button to copy heat parameter from ID1 to get ID1~1, then edit the new value ID1~1.

**New add or edit in bulk:**

1. Plug a USB flash into the machine USB port.
2. Click on **EXPORT TO USB** button. Then unplug the USB.
3. Find the file from USB via PC, refer to the file name show in . Open the file and try to new add or edit refer to exist parameter.
4. Plug the USB back to machine USB port and click on **EXPORT FROM USB**.



Choose USB flash disk no more than 32G, as fat32 format.

## 5.4 Production Counter

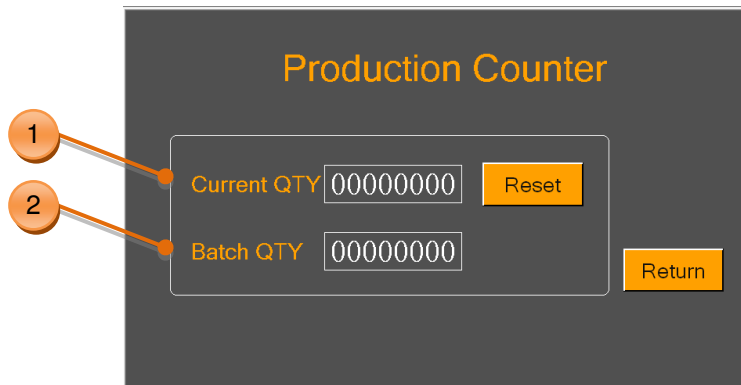

Fig.14 Production Counter page

1. Real-time production quantity counter.

The number here will +1 automatically after each product run through the heating chamber and drop down to collection bin. Operator can press and hold the **RESET** button for 5S, to clean the counter value.

2. Operator can preset the production target (quantity) here.

- If you input the value, when machine complete the setting batch quantity, on the main interface will pop up a tip “Complete!”, to remind the operator current batch production is completed. (See below capture, operator need to clean this message manually by clicking on close button). The Batch QTY will continuously start the next batch count automatically.
- If you input value “0”, no “Complete!” message will pop up.

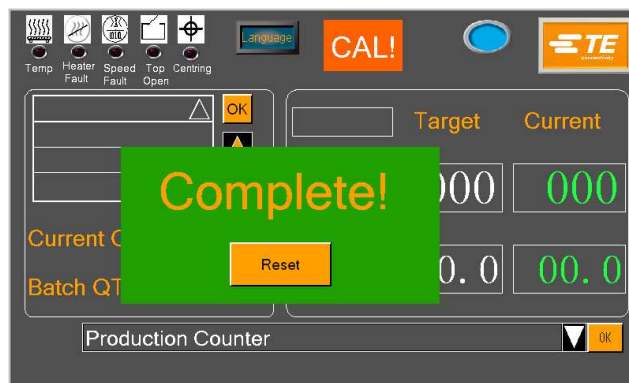

Fig.15 Production Counter (complete!)

## 5.5 Maintenance

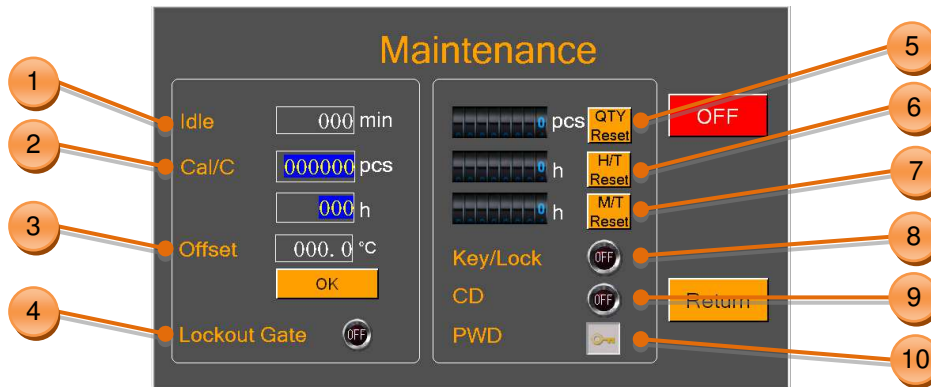

Fig.16 Maintenance page

1. Time to standby, the machine will entry standby mode automatically if no action or no new product was feed. *Default value: 60 mins, turn OFF this function by input value "0".*
2. Machine Calibration Counter, by cycle (pc) or by Hour.  
*Default value: 75000 pcs / 350 Hours*
3. Temperature Compensate; Enter the value and click OK to Write.
4. Switch ON, to activate optional Lockout gate when Lockout gate is installed. Meanwhile timing belt reverse function will be inactivated.
5. Machine cycle counter, designed to indicate production QTY after leave factory.
6. Heater timer, which is designed to indicate the hours the heater operates. It is necessary to reset this counter when replaced the heater.
7. Motor timer, which is designed to indicate the hours the motor operates. It is necessary to reset this counter when replaced motor.
8. Key lock.  
*OFF, machine allow operator to shift heating parameter by click on process dropdown list in Main Interface. ON, machine won't response when operator click on process dropdown list.*
9. Centering Device Switch, to activate Centering Device when optional Centering Device is installed. Switch OFF when optional Centering Device is not available.
10. Change password. Higher level authority can change lower-level authority log on password.



*When click on icon, it will pop up the window left. You can change the password in this window. (This window shown, is log on as MFG.)*

## 5.6 Calibration (Temperature)

To ensure the same type XB Belt Heater are operating at the same heating element temperature and to ensure reliable results when using the Raychem recommended installation conditions, the machine should be calibrated using the following procedure.



The Belt Heater must be calibrated every time one of the following occurs:

- Heater is changed.
- Temperature controller is changed.
- Motor is changed.
- Motor driver is changed.
- First time installation, or environment is changed.
- “Call!” message pop up in Main Interface. See Fig.12
- Whenever the heating performance is not good as usual.

### Calibration setting:

- Heater Temperature: 600 °C
- Timing Belt Speed: 10.2mm/s
- Probe target Temp: 130 °C ± 5°C for XB17, 150 °C ± 5°C for XB19.

### 5.6.1 Auto Calibration

#### Calibration Tool:

- UHI 250A probe. (TE PN: 7-1192190-9, ORDER-NO: 288869-000)
- Extension Cable. (TE PN: 9-2375314-6)

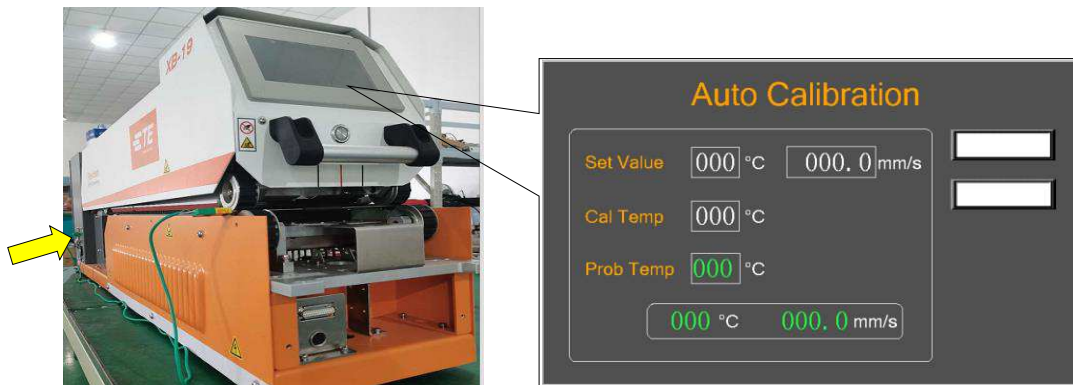

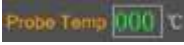
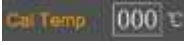

Fig.17 Auto Calibration

#### Automatic Calibration Procedure

1. Connect the UHI probe to the calibration socket in left side of electrical cabinet.
  - Touch panel will entry Auto Calibration page automatically. Refer to Fig.17
  - The heating parameter stored in “Set Value”, will upload and change machine’s temperature and belt speed.
  -  When these 2 values turn green. Allow a further 15 minutes for heater temperature to stabilize.
2.  When this value turns green (23+/-3 °C) timing belt will move forward. Operator can

feed the UHI probe into heating chamber centrally.

- UHI probe will enter from the entrance.
-  This value which is showing probe's real-time temperature, start to rise.
-  This value will show the probe's peak temperature when calibration finished.

3. When the UHI probe go through the heating chamber, it will be drop down to collection bin. DO NOT UNPLUG THE UHI PROBE AT THIS STAGE. Allow 15 seconds for machine to calculate and adjust OFFSET automatically after UHI is ejected. At the same time of temperature calibration, UHI probe is also used for speed detection. When calibration finished, 2 blanks on page right will show the calibration result.

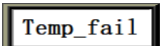
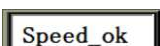
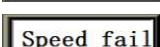
-  Calibration success. Offset value was updated automatically
-  Calibration Fail. Need to redo calibration
-  Belt Speed is correct.
-  Belt Speed is wrong, stepper motor fail, need to replace motor.

### 5.6.2 Manual Calibration

**Calibration tool:**

- UHI 250A probe. (TE PN: 7-1192190-9, ORDER-NO: 288869-000)
- Extension Cable. (TE PN: 9-2375314-6)
- Thermometer. (TE PN: 9-2375314-7)

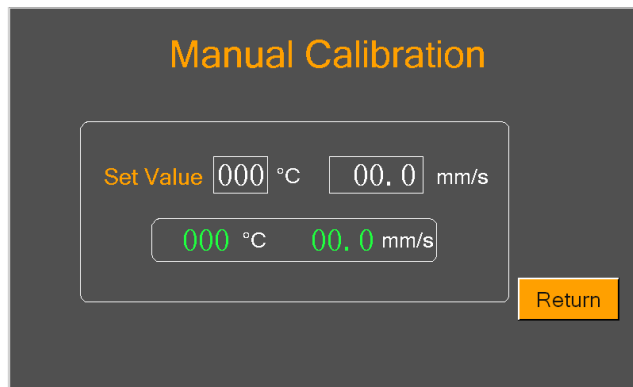



Fig.18 Manual Calibration

**Manual Calibration Procedure**

1. Login on to Manual Calibration page.
  -  heating parameter in “Set Value” will upload and change machine’s temperature and belt speed.
  -  When these 2 values turn green. Allow a further 15 minutes for heater temperature to stabilize.
2. Connect UHI probe to thermometer. Read the real-time temperature of UHI probe from thermometer, make sure its temperature was cooled to 23+/-3 °C before feed to heating chamber.
3. Carry out 3 times’ calibration, then record each UHI probe peak temperature from thermometer.



4. Calculate Adjust offset value, then update it to machine “OFFSET” value in maintenance page manually.

**How to calculate new offset:  $\text{New Offset} = \text{Old Offset} + (\text{Avg. probe} - \text{Target}) \times 2$**

- Old Offset. Read from Maintenance page.
- Avg. probe = (probe peak temp1 + probe peak temp2 + probe peak temp3) / 3
- Target (XB17=130 °C, XB19=150 °C)

**Example 1 (For XB19)**

If the average probe peak temperature is 170°C, old offset is “-15”, target temp is 150 °C.  
New offset = “-15” + (170 – 150) x 2 = ”25”

**Example 2 (For XB17)**

If the average probe peak temperature is 110°C, old offset is “-15”, target temp is 130 °C.  
New offset = “-15” + (110 – 130) x 2 = ”-55”



After new offset is input, it is necessary to wait 15 minutes for temperature to stabilize before production.

## 5.7 Remote Mode

The remote mode allows the XB Belt Heater to be controlled by external devices such as an industrial Computer or Ultrasonic Welding equipment, via connecting the RS232 communication interface with external device. (The TE heat shrink processing machine was tested and proved functional with the major ultrasonic welding machine available in the markets, consult with TE for any communication difficulty occurs.)



Fig.19 Remote Interface (RS232 connector)



Customers need to prepare the communication cable (DB9, female to female) by themselves. See below wiring map for this cable connection. Or purchase it from TE. (Section 8.3.6)

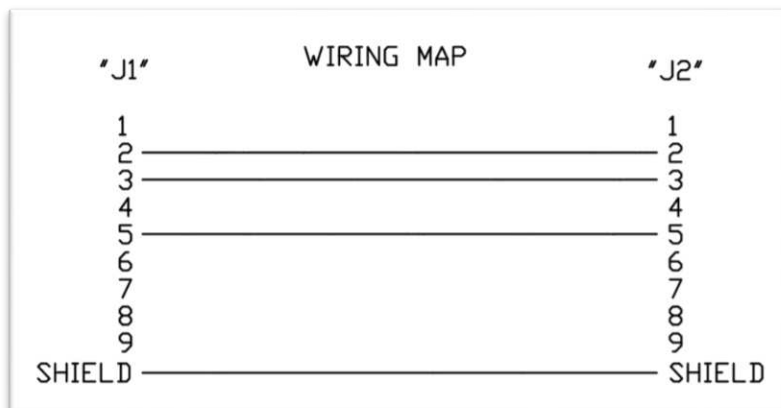

Fig.20 Wiring Map for RS232 communication interface

### 5.7.1 Remote operation Procedure

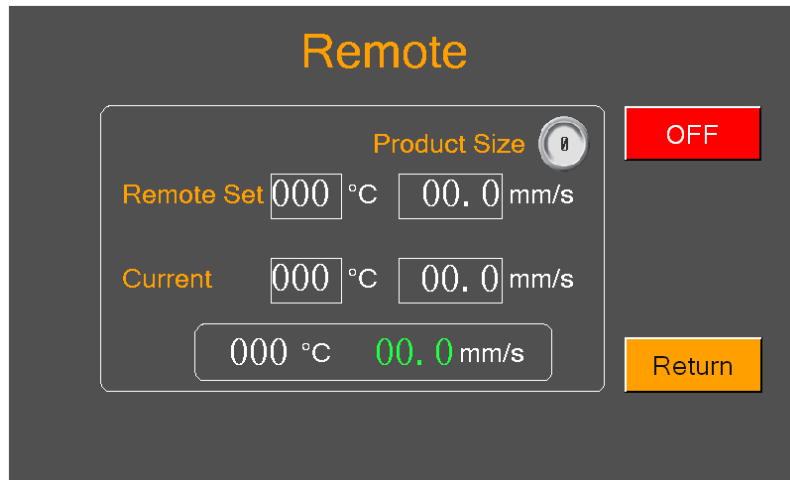

Fig.21 Remote operation Procedure

1. Connect XB Belt Heater with external device via the RS232 communication interface, like Ultrasonic Welding equipment.
2. Switch **OFF** to **ON**, allow the machine to communicate with external device.
3. **Remote Set 000 °C 00.0 mm/s** These values are showing the parameter (Product Size / Temperature / Speed) transferred from external devices.
4. **Current 000 °C 00.0 mm/s** These values are showing the parameter which machine is going to carry out.
5. **000 °C 00.0 mm/s** These fluctuant values are showing the real-time parameter for machine.
6. When XB Belt Heater connect with external device. You can confirm if connection is working correctly by checking the value on "Current" and "Remote Set" is comply with the parameter in external device.
7. Switch **ON** to **OFF**, to shut off the communication with external device.
8. Click on **RETURN** button, to back to main interface.

## 5.7.2 RS232 Data Format

All data is transmitted in ASCII form. The Data format uses 8 data bits, 1 stop bit, no parity at 9600 baud. Full duplex TX/RX exists, RTS/CTS is disabled. The XB Belt Heater recognizes the following fourteen bytes information packet structure.

BYTE 1	Start of Header (SOH) (always ASCII 01h)
BYTE 2	10'mm/s of speed (ASCII 30h to 39h (1 to 9))
BYTE 3	1mm/s of speed (ASCII 30h to 39h (1 to 9))
BYTE 4	Always a decimal point (ASCII 2Eh)
BYTE 5	0.1mm/s of speed (ASCII 30h to 39h (1 to 9))
BYTE 6	Always a NULL (always ASCII 00h)
BYTE 7	Product size code (ASCII numeric – (1 to 3) – see below)
BYTE 8	Product size code (ASCII numeric – ('_' or A)– see below)
BYTE 9	100's of deg. C
BYTE 10	10's of deg. C
BYTE 11	1's of deg. C
BYTE 12	Checksum high hex nibble (ASCII value 0–9 A–F) F)
BYTE 13	Checksum low hex nibble (ASCII value 0–9 A–F)
BYTE 14	End of transmission (EOT) (always ASCII 04h)

The checksum hex (A-F) must be in ASCII lower case.

The XB Belt Heater will ignore all RS232 data until a SOH character is recognized. On receipt of a SOH, 10 additional characters or an EOT character is sought. For each character received (including the SOH) the longitudinal addition (checksum) is maintained up to and including byte 11. Overflow of the checksum beyond a byte boundary is discarded; This single byte checksum is converted to two ASCII characters and compared with bytes 12 and 13 of the received packet.

The XB Belt Heater responds 100ms after receipt of the above data packet with either a single ACK (acknowledgement) (ASCII 06h) or a NAK (not acknowledgement) (ASCII 15h) character. An ACK response will occur providing the following verifications are met:

- The checksum Byte compares.
- The packet format meets the above defined format. (i.e., The decimal point and null characters occur in the correct positions and the expected numeric values represented by ASCII 30–39 are present).

Failure to meet these requirements results in the XB Belt Heater responding with a NAK. The only exception unchecked is product size value.

The two ASCII values designated product size are unchecked as part of the receive protocol other than being included in the checksum calculation (i.e. any data received in these positions will not result in NAK response).

## 5.8 System Parameter

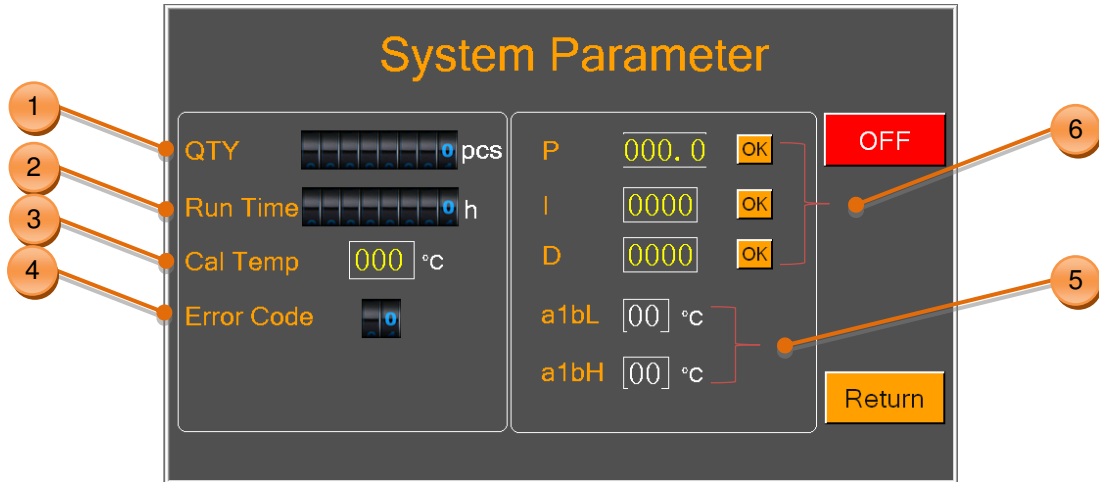

Fig.22 System Parameter

1. Machine cycle counter. This value cannot be reset. It will record the total cycle after machine leave TE factory.
2. Machine timer. This value cannot be reset. It will record the total operating hours after machine leave TE factory.
3. Calibration Temp, Probe target temperature after ran through heating chamber.
4. Error Code for temperature controller. Detail information can find on manual of OMRON E5CC.

5. **a1bL** [00] °C Lower alarm temperature, default value 10°C.

**a1bH** [00] °C Higher alarm temperature, default value 10°C.

*Upper and lower limit for the temperature. When real-time temperature reached this range, heater light will show green, timing belt will change to move backward. Ready for production.*

6. PID control. These parameters have to be carefully adjusted together and are factory set.

**P** [000.0] **OK** Proportional Band, Area around the selected process temperature where the output is at a level other than 100% or 0%. Increasing this parameter increases the width of this band. **I** [0000] **OK** Integral. Corrects offset between selected process temperature and the proportional band over time. Increasing this parameter increases the time it takes to correct this offset.

**D** [0000] **OK** Derivative. Shifts the proportional band relative to the actual process temperature damping the process temperatures tendency to over/under shoot when changing. Increasing this parameter will lengthen the time to change to another process temperature.

## 5.9 Barcode Scanning

Machine can work with barcode scanner. When scanner read the barcode, machine can record the parameter to external USB storage, also machine can load the heating parameter program in the barcode, then the machine can change heating parameter automatically.



**Wireless Barcode Scanner (Optional, TE PN 9-2375314-9)**

### 5.9.1 Barcode Scanning mode

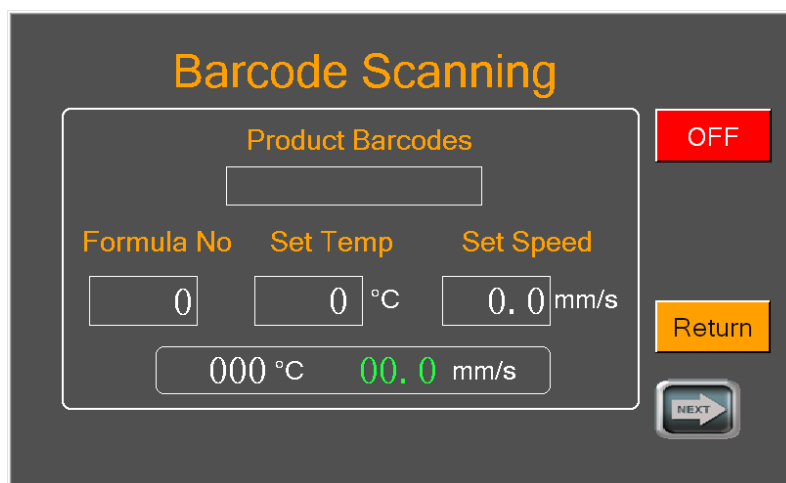

Fig.23 Barcode Scanning mode

1. Connect Barcode Scanner with machine, via USB port (Fig.2 ).
2. Access to “Code Reading” page by login on as engineer (authority “C”)
3. Click on the “OFF” button to switch to “ON”, to activate Barcode scanning function.
  - If scan barcode successfully, parameter will upload to update the parameter in the page.
  - If fail, touch panel will pop up message “Barcode error”.



Click on “Ignore”, will ignore this error and remains last barcode.  
 Click on “Re-scan”, allow to re-scan the barcode again.  
 Or entry “Manual Code Input” page, to input code number manually.

4. Switch “ON” to “OFF” and click on **RETURN** button, to quit Barcode Scanning mode, page will jump to Main interface.
5. Click on “Next” button, will allow to edit or preset Code settings. Customers need to preset the Code setting before operating in Barcode Scanning mode.

## 5.9.2 Code setting

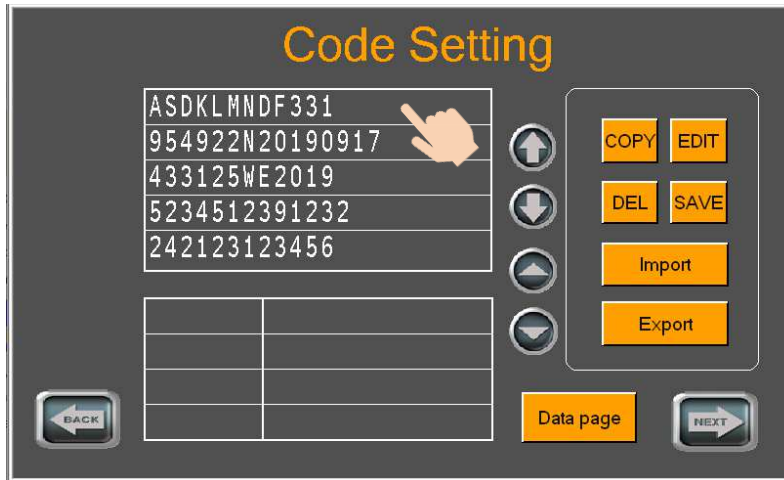





Fig.24 Code Setting

There are two ways to write barcode data:

1. Edit one by one, in the touch panel interface:
  - Modify: Select the barcode from top table in “Code settings” page, the bottom table will show the exist parameter stored in this selected code. Click on “EDIT”.
  - New add: Select any barcode in top table and click on “COPY” button, the barcode data will copy to new code, and then modify the new code.
2. Import barcode data external USB disk.
  - a. Insert a USB disk into the USB port, and click on “Export” button on HMI to download the existing data from the touch panel to the USB disk;
  - b. Unplug and check on USB disk via PC, will found it generated a folder  Recipe .  
Try write new barcode by editing the excel file  00001\_Recipe Group1 in folder  Recipe , refer to the original parameter and save.
  - c. Insert the USB disk back to machine USB port and click on “Import” button to upload barcode data to the touch panel.

### 5.9.3 Manual code input reading

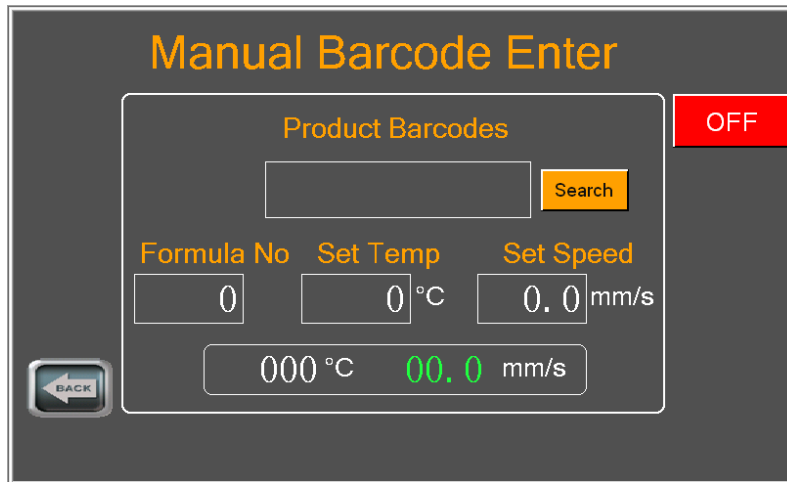

Fig.25 Manual Code Input

In this page, you can input the barcode number manually in the blank and search the data. Switch the “OFF” button to “ON”, to allow editing. And Switch to “OFF” when finished.

### 5.10 Error Log

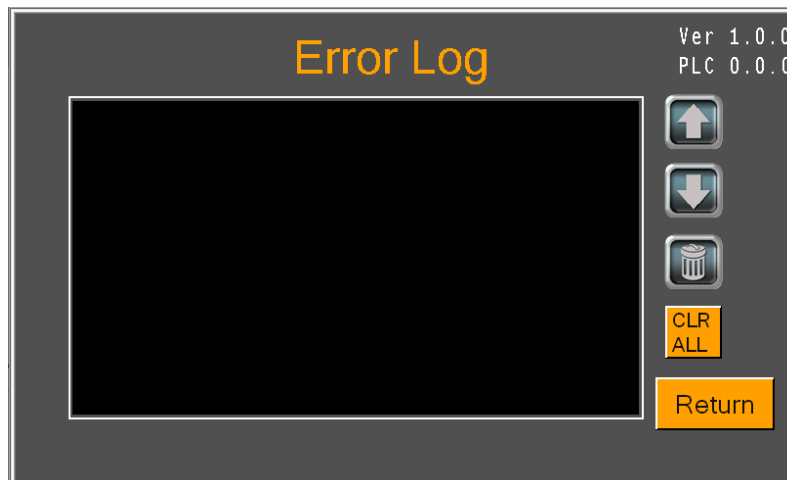

Fig.26 Error Log

Equipment failures will be recorded and saved on this page for future reference.

In this page top right is showing the current revision for PLC and HMI program.



## 5.11 Data Collection

Machine can collect production data in HMI automatically and allow to export to external USB disk manually.



**Customers need to prepare USB flash by themselves. No more than 32G, as fat32 format.**

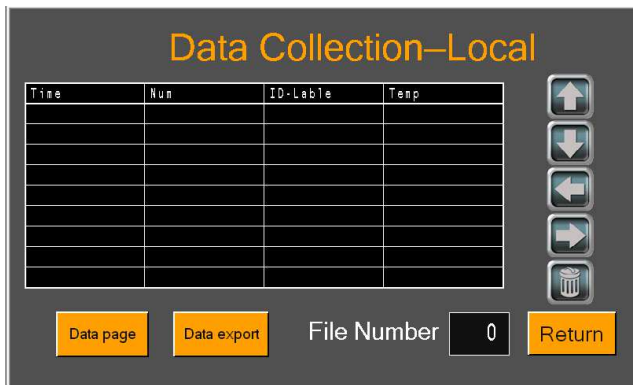

Fig.27 Data Collection - Local

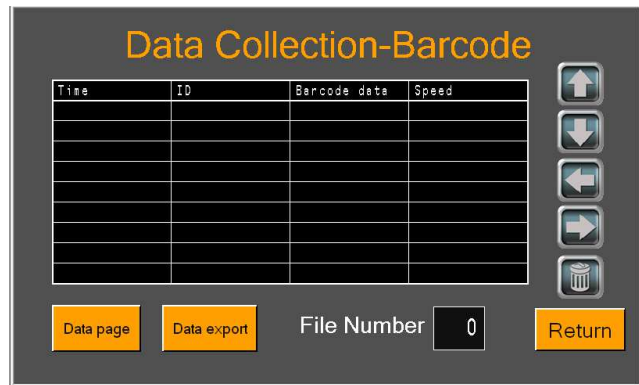

Fig.28 Data Collection - Barcode

### 5.11.1 Data Collection - Local

Operation without barcode scanning, machine can only record the 10X process parameters stored in machine. Access to “Data Collection-Local” page to review the production information on touch panel. Or operator can download the production information to external USB disk.

- Click and input “File Number” to name the document name to export.
- Click on “Data export” button to export the production information to USB disk.
- Click on “Data page” button, to review and double check on the export document in USB disk.
- Click on “Return” button will access to Main Interface.

### 5.11.2 Data Collection - Barcode

Operation with barcode scanning, machine can record those information recognized from barcode. Access to “Data Collection-Barcode” page to review the production information on touch panel. Or operator can download the production information to external USB disk.

- Click and input “File Number” to name the document name to export.
- Click on “Data export” button to export the production information to USB disk.
- Click on “Data page” button, to review and double check on the export document in USB disk.
- Click on “Return” button will access to Main Interface.

## 5.12 Centering Manual

I/O page for Centering Device operation. In this page, engineer can also control the Centering Device to move step by step.

**T/P** ---- *Tube Pusher, consists of left push plate and right push plate which designed to push tube to center.*

**Probe Up/Down** ---- *Detection Unit Up/Down. Detection Unit consists of left detection probe and right detection probe. It will move to up (detection position), move to down (home position) getting out the way of T/P centering.*

**Clamp** ---- *Clamping Cylinder, they were designed to clamp both ends of cable assembly.*

**Feed** ---- *Feeding mechanism, clamping cylinder will carry splice move to machine entrance.*

**Splice in position** ---- *Indicator will illuminate when both detection probes contact with splice successfully.*

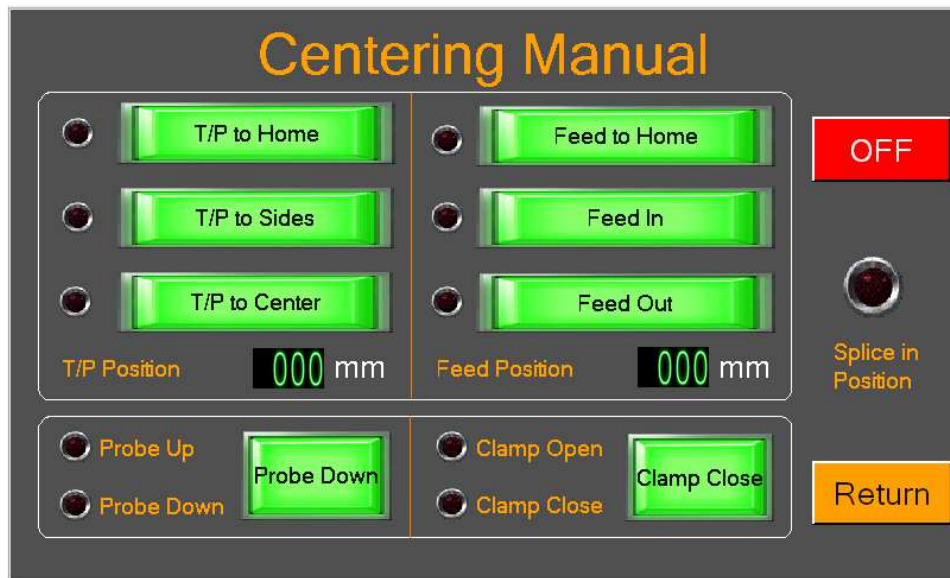

Fig.29 Centering Manual

## 6 Maintenance

The XB Belt Heater is a very low maintenance machine; however, a few minutes of maintenance each week will ensure its reliability and long service life. The following are guidelines for daily, weekly, and monthly maintenance procedures that will keep the XB Belt Heater in optimum working condition. Don't wait until the machine has a problem to give it some attention.

### DANGER!



These procedures should be performed only by qualified maintenance personnel. To minimize the risks of burns, electrical shock, or other injuries, all safety precautions must be observed.

The heaters remain hot after the belts and fans stop moving. To avoid any burns or injury during maintenance, wait an additional 15 minutes after the normal cool down cycle is complete before beginning.



Do not use solvents for cleaning. Solvents are unnecessary and may damage some components of the machine.

### 6.1 Daily Maintenance

Before the daily production begins, while the machine is cool, take a few minutes to perform the following steps.

- **Clean and inspect the belts and pulleys.** Using a dull soft tool (wood or brass dowel), remove any adhesive or foreign matter from the belts and pulley grooves. Ensure that the belts are seated properly in the timing grooves and the grooves are clean. Adhesive buildup in the timing grooves may cause the belts to 'walk' off the pulleys.
- **Clean and inspect the heaters.** Using a soft scraping tool, soft wire brush, or wet cloth, clean any adhesive or foreign matter from the quartz face of the heating elements. Ensure that the heaters are securely fastened in place.
- Calibration is needed.
- As the machine warms up for normal operation, check the general condition of the machine. Ensure that all the fans are operating.
- Listen for any grinding or clicking noises. The belts should be running smoothly without a jerky motion.
- All covers must be securely in place. Make any repairs or adjustments necessary to return the unit to proper working order.

## 6.2 Weekly Maintenance

In addition to the daily procedures, perform the following procedures every week or after 40 to 50 hours of operation.

- **Check the belts for alignment.** Make sure the belts are seated properly in the timing pulleys, and that the pulley grooves are clean. Make sure the pulleys are in alignment and securely in place. With the top chamber closed, make sure the top belts mesh with the bottom belts.
- **Check the belts for tension.** With the top chamber open, measure the free-play distance at the center of each belt. The distance between the belt and foam pad, or guide, should be between 19mm (0.75 in).

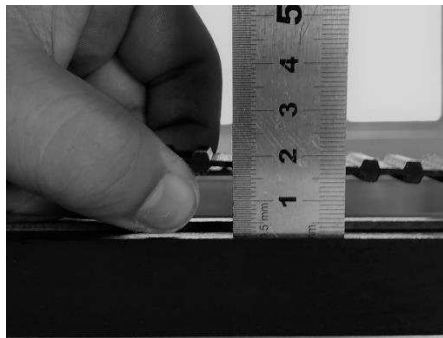

Fig.30 Checking Belt Tension with a Ruler



*Belts that are too tight will prematurely wear the bearings and belts.*

- **Verify that the upper floating rails contact the upper belts.** With the top chamber open, inspect the position of the upper rails. If they do not touch the belts along the entire length of the rail, adjust the spring-loaded bolts on either end of the rails. If the rails do not make contact with the belts, smaller assemblies may not be gripped sufficiently and will tend to roll through the heating chamber. Silicone the belts. With the belts turning, spray silicone (not solvent or oil) over the entire length of the belts. This will increase the life of the belts significantly.

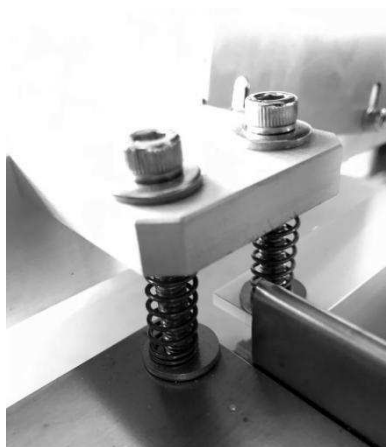

Fig.31 Rail Springs

- General condition check. As the machine warms up for normal operation, check its general condition. Ensure that all the fans are operating and listen for any grinding or clicking noises. The belts should be rotating smoothly without a jerky motion. All guards and covers must be securely in place. Make any repairs or adjustments necessary to return the unit to proper working order.

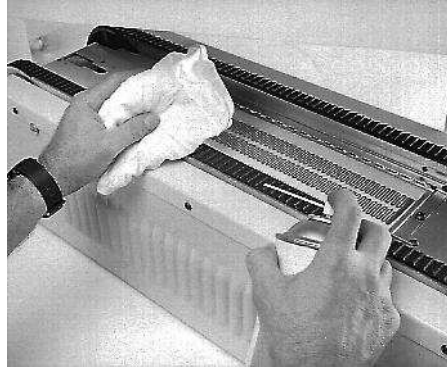

Fig.32 Spraying Silicone over the belts

## 6.3 Monthly Maintenance

Don't wait for the machine to break down before giving it some attention. Take a few minutes each month to perform the following procedures. This should ensure a long and reliable service life with minimal downtime for repairs.

- Clean the inside of machine of dirt, dust, or any foreign material. Open each side panel and (with an air hose, vacuum, or damp cloth) clean out any dirt, dust, wires, tubing, adhesive, or anything else that has been trapped inside the machine.
- Inspect the belts. If the belts are worn and fibers are peeling off, replace the belts.

**Grease the belts for inside track weekly with silicone will increase the life of the belts. (Recommended silicone: Molykote DC111)**



Fig.33 Motor Brushes

- Check and tighten the bolts for those movement components. Like pulley, pulley mounting block, gears in transmission module.

## 7 Troubleshooting



If the machine is still inoperative after following the troubleshooting and repair procedures in this manual, contact your local TE representative.

### **DANGER!**



Some troubleshooting procedures require the machine's power to be ON. To minimize the risk of burns, electric shock, or other injuries, these procedures should be performed only by a qualified maintenance person, and all safety precautions must be observed.

Wear protective gloves to prevent possible burns or electric shock. The heaters remain hot after the belts and fans stop moving. To avoid any burns or injury during troubleshooting, before you begin wait an additional 15 minutes after the normal cool down cycle is complete.

## 7.1 Alarm Message

Alarm Message	Possible Cause	Corrective Action
Standby time is up!	The time that operator doesn't operate the machine is longer than the standby time, the machine is in standby mode automatically	Reboot device
Emergency Stop!	Emergency stop button be pushed	Release the emergency stop button
Temp controller comm error!	The communication cable between PLC and temp controller is damaged	Check the communication cable between PLC and temp controller
	The PLC communication port is damaged	Check the PLC communication port
	The temp controller error	Check the temp controller
Temperature error!	Actual temperature is higher than 810°C(XB19)/730°C(XB17)	Check the temp sensor
		Check the temp controller
Heating failure	After 90s, actual temperature is lower than 180°C when set temperature is higher than 200°C	Check solid-state relay
		Check Master control relay
		Replace the master control relay.
Temperature error! check heating circuit!	Actual Temperature is higher than set temperature 10°C or lower than set temperature 10°C	Check the connect between temperature controller and PLC
Upper heating chamber open	The upper heating chamber was artificially open.	Close the upper heating chamber and restart the equipment
	The upper heating chamber detects sensor damage	Check and replace the sensor
Upper heating chamber overheat	The temperature of the upper heating chamber is too high, which causes the overheating sensor to work	Check and cool down
	Overheat sensor damage	Check and replace the overheating sensor
Motor fault	Belt motor driver alarm	Check connections between the motor driver and the motor.
		Check the driver and replace as necessary.
Clamp open alarm	Clamp open sensor not detect	Check the clamp open sensor
Clamp close alarm	Clamp close sensor not detect	Check the clamp close sensor



Alarm Message	Possible Cause	Corrective Action
T/P Motor Alarm	T/P motor driver alarm	Check connections between the motor driver and the motor.
		Check the driver and replace as necessary.
Feed Motor Alarm	Feed motor driver alarm	Check connections between the motor driver and the motor.
		Check the driver and replace as necessary.
T/P to Side Fail	T/P motor side sensor not detect	Check the side sensor
T/P to Center Fail	T/P motor center sensor not detect	Check the center sensor
Tube Missing	Tube sensor not detect	Check the tube sensor
		check the tube is missing or not
Probe Up Alarm	Probe up sensor not detect	Check the probe up sensor
Probe Down Alarm	Probe down sensor not detect	Check the probe down sensor
CD Door Open	Door opened	Close the CD door



## 7.2 Troubleshooting Guide

Problem	Possible Cause	Corrective Action
No power in the machine.	Main power source is not connected.	Connect the power source.
	Emergency stop button is depressed.	Turn and release the emergency stop button.
	Main Switch is OFF.	Turn ON the Main Switch.
	Main Switch is defective	Replace the Main Switch.
	I/O push-button has not been pressed.	Press the I/O push-button.
	I/O button failure	Replace the I/O button
	Fuse FU1/FU2 is blown.	Replace the fuse.
Power to the machine drops as soon as the ON push button is released, without entering cool-down mode.	Fuse FU4 is blown.	Replace the fuse.
	Cooling fan relay is defective.	Replace the fan control relay
	Cooling fan is defective.	Replace the cooling fan.
Heaters will not reach set point.	Heater failed (see Section 7.2).	Replace as necessary (see Section 8.2.3).
	Thermocouple or thermocouple lead wire is faulty between controller and heater (see Section 7.3.1).	Repair as necessary.
	Thermocouple in upper heater is faulty (see Section 7.3.1).	Replace the upper heater (see Section 8.2.3).
	Solid-state relay is defective (see Section 7.4).	Replace the solid-state relay.
	Temperature controller is defective.	Replace as necessary.
	Temperature controller is not programmed correctly.	Reset the parameters
Temperature control varies.	Thermocouple wire is faulty.	Repair the thermocouple wire or replace the upper heater (see Section 8.2.3).
	Temperature controller is not programmed correctly	Reset the internal parameters
	Excessive air movement around machine.	Check for external fans or air conditioning that may be blowing excessive air at the machine.

Problem	Possible Cause	Corrective Action
No power to heaters.	I/O button was not activated.	Press I/O button for 5S to activate it.
	Solid-state relay is defective (see Section 7.4).	Replace the solid-state relay.
	Master control relay is defective (see Section 7.6).	Replace the master control relay.
	Temperature controller set point is too low.	Increase the set point as necessary.
	The heating fuse blew	Check the heater and replace the fuse
	Temperature controller is defective.	Replace the controller.
	Electrical connections are faulty.	Ensure the integrity of the connections.
Heaters will not shut off.	Temperature controller is defective.	Replace the controller.
	Solid-state relay is defective (see Section 7.4).	Replace the solid-state relay.
Fans don't operate.	A fan is defective.	Replace the defective fan.
	Fan fuse is blown.	Replace the fuse. (FU4)
	DC power supply failure.	Replace the DC power supply/drive fault detector board.
	Low-voltage transformer failure.	Replace the low-voltage transformer.
	Faulty electrical connections to fans.	Ensure the integrity of the connections.
Belts don't move.	Set screws and keys are loose or missing on the drive pulleys.	Align pulleys and tighten set screws.
	Electrical connections are faulty.	Check connections between the motor driver and the motor.
	Motor driver is defective (see Section 7.5.2).	Check the driver and replace as necessary.
	Motor fail (see Section 7.5.3).	Replace motor as necessary.
No variable speed control.	Motor driver failure.	Replace the driver (see Section 8.2.5).
	CPU speed control failure.	Replace as CPU



Problem	Possible Cause	Corrective Action
Belts walking off pulleys.	Belts are too loose.	Adjust tension (see Section 6.2).
	Upper rails are not adjusted properly.	Adjust position of rails (see Section 6.2).
	Pulley grooves are dirty.	Clean the pulleys
	Assemblies are dragging behind the splice location.	Adjust the position of the assemblies (toward middle of machine).
No grip on wire assemblies being processed.	Floating rails are not adjusted properly.	Adjust pressure on rails (see Section 6.2).
Count Error	Parts Sensor Failure	check the out sensor and replace as necessary.

## 7.3 Heater Test

If a heater has failed, the touch panel will indicate that heating failed. The temperature controller will cease to display the element temperature. The following procedure will determine which heater has failed.

- When the machine is cool, turn OFF the Main Switch and unplug the power cord.
- Remove the top and side panels
- Measure the heater resistance at terminal blocks T5 and T8, located near each element



If the resistance of both heaters is acceptable and a heater fault continues to occur, the problem is likely one of the heater power relays KA1.

## 7.4 Temperature Control Circuit Test

The temperature circuit consists of the temp controller, thermocouple over temperature switch, and cool down timer circuit. The following procedure describes the test for each circuit.

### 7.4.1 Thermocouple Check



The upper heater and the thermocouple are assembled as a single unit. If a damaged wire or insulation cannot be repaired, the upper heater must be replaced.



Fig.34 Temperature Controller

When the machine is cool, turn OFF the Main Switch and unplug the power cord.

- Open the electrical cabinet.
- Disconnect either thermocouple lead from the rear of the temperature controller and measure the resistance across thermocouple wires. If the resistance is infinity, the wire is broken. If tracing the length of the wire does not reveal the break, it may be inside the upper heater. Continue with the following steps.

- Remove the top sheet metal cover.
- Disconnect the miniature thermocouple plug and measure the resistance from the male end connected to the heater. If the resistance is greater than  $2\Omega$ , replace the upper heater. If the resistance is less than  $2\Omega$ , the fault lies in the extension wire between the plug and the temperature controller.

### 7.4.2 Over temperature Circuit Test

A normally closed resettable thermal switch, located in the upper heating chamber, senses when there is an over temperature condition. Should an over temperature condition occur, the touch panel will show the heating chamber to overheat, the timing belt moving forward (lockout gate will rise), and power to the heaters will be shut off.

When the machine is cool, turn OFF the Main Switch and then turn it back ON.

Press the I/O button. If the machine immediately illuminates the over temperature indicator light and goes into cool down mode even though the machine is cool, the over temperature switch (TSW1) is defective and must be replaced.



The over temperature switch (TSW1) can be checked directly by measuring the resistance across the terminals of the switch. The resistance should be  $0\Omega$ . If the resistance is infinity, replace the switch.

- Remove the top sheet metal cover.



*Fig.35 Overtemperature Switch (TSW1)*

- Remove the bracket (with the over temperature switch attached) from the top of the upper heating element shield.
- If the switch is closed (alarm is OFF), apply heat to the switch with a heat gun. The switch should then open (over temperature light illuminates) at a temperature of approximately  $200\text{ }^{\circ}\text{C}$ . If the switch does not open, replace it.

## 7.5 Solid -State Relay Test

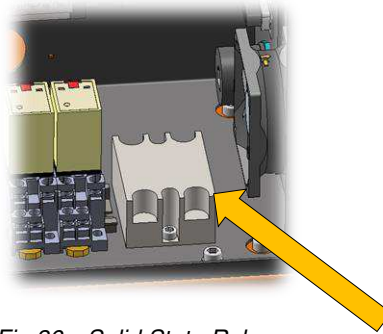

Fig.36 Solid State Relay

### DANGER!



Only a qualified electrician should perform this test with machine power on, and should wear electrical insulating gloves and follow all electrical safety precautions when performing the test



The first part of this test is performed while the temperature controller is supplying full power to the heaters. The second part of the test is performed with the temperature controller supplying no power to the heaters.

- After the machine has cooled down, open the electrical cabinet cover and remove the Plexiglas cover on the solid-state relay.
- Press the I/O button.
- Set the temperature control to 600 °C.
- Measure the input voltage across terminals #3 and #4 of the solid-state relay.
- When full power is on to the heaters, the voltage measured should be approximately 24 Vdc. If no voltage is present, check the output of the temperature controller and the electrical connections between the temperature controller and the relay.
- Measure the output voltage across terminals #1 and #2. If there is power to the heaters, the voltage measured should be approximately 0 Vac. If the voltage present is significant (>3 Vac), the solid-state relay has an open circuit; replace the relay. If the relay is not open and still fails to heat up, check the heater power relays.
- Lower the set point of the temperature controller to 20 °C. This part of the procedure is performed with no power supplied to the heaters.
- Measure the input voltage across terminals #3 and #4. The voltage should be approximately 0 Vdc. If significant voltage is present, the temperature controller is defective.
- Measure the output voltage across terminals #1 and #2. The voltage measured should be the line voltage (200 to 260 Vac). If no voltage is present, the solid-state relay is shorted.

## 7.6 Drive Circuit Test

The drive circuit consists of the Closed-loop stepper motor, motor driver, and PLC and all interconnections.

### DANGER!



This test is performed with the machine power on. Wear electrical insulating gloves and follow all electrical safety precautions when performing this procedure.

### 7.6.1 PLC drive Test

- Open the electrical cabinet cover to gain access to the PLC.
- Measure the input DC voltage across terminals L+ and M, wires #5 and #104. The voltage measured should be direct current 24V DC. If it is not, check the line on the controller board.
- When XB Belt Heater is in working, its PLC pulse output terminal Q0.0 and Q0.2 will emit pulse in reverse according to the operation, the status display lamp will be lit, and its feet #34, #36, and #104 will output 24V DC, to drive the stepper motor.



Fig.37 PLC module

- If the Q0.0/Q0.2 indicator is flashing but no voltage output, then the PLC is at fault.

## 7.6.2 Stepper motor driver

- Open the electrical cabinet cover to gain access to the stepper motor driver.
- Measure the input DC voltage across terminals V+ and V-, wires (21) and (104). The voltage measured should be 24 V DC. If it is not, check the line on the controller board.
- Check whether the dial code of the motor driver is correct. See circuit diagram P6 for the specific setting.
- Check the wiring of the motor. If the wiring is damaged, the motor may not run or be in the wrong direction.
- There are two indicator lights on the stepper motor driver. According to their state, the cause of motor failure can be determined:



When 1 green and 1 red flash alternately, it indicates phase overcurrent;

When 1 green and 2 red flash alternately, the motor phase is open;

When 1 green and 4 red flash alternately, it indicates low power supply;

When 1 green and 5 red flash alternately, it indicates that there is other fault (for example: out-of-tolerance position).

When the above protection function starts, the motor shaft loses the self-locking force. To restore normal operation, the above faults need to be confirmed to be eliminated. Then the power is restarted, the power indicator is always on green, the motor shaft is locked, and the driver is restored to normal.

Fig.38 Stepper motor driver

## 7.6.3 Motor Resistance

- Disconnect power to the machine.
- Disconnect either wire from A + and A - /B+ and B- on the motor driver board to measure the resistance to the motor between wires # 53 and #52. The resistance should be approximately 10.3Ω. If the resistance is significantly higher or lower, replace the motor.



Fig.39 Stepper motor and driver



## 7.7 Safety Relay Test



Fig.40 Safety Relay (KS1)

- Open the electrical cabinet to gain access to the Safety Relay.
- Turn on the air switch, make sure the emergency stop button is not pressed;
- The relay should activate, apply power to the drive circuit.
- Measure the voltage on the coil of the relay on terminals #5 (A1) and #104 (A2); The voltage should be approximately 24 V DC. If there is voltage, but the relay is not active, the relay is defective.
- The safety relay apply power to the stepper motor, cooling fan, heating control circuit and power to the middle mechanism, check these components as required
- Under normal working condition, the indicator light of K1, K2, K3 and K4 will be on.



Please test the actual circuit according to the circuit diagram.

## 7.8 DC Power Supply / Drive Fault Detector Circuit Test



Fig.41 DC Power Supply

DC power supply provides power supply for the whole machine (except heating elements).

- Measure the voltage on the coil of the relay on terminals #4 (L) and #103 (N);
- The voltage should be approximately 220V AC. If there is voltage, but the relay is not active, the relay is defective.
- Measure the voltage on the coil of the relay on terminals #5 (+V) and #104 (-V); The voltage should be approximately 24V DC. If there is not voltage, the relay is defective.
- With the machine cool and the Main Switch OFF, remove the back cover of the collection bin. The power supply is located above the power transformer. Remove the fuses on the PCB and check it for continuity. If the resistance is infinity, replace the fuses.



XB17 has two input power supply specifications of 115V/230V. For different voltages, the power supply needs to be switched by dial code switch, as shown in Fig.42 .

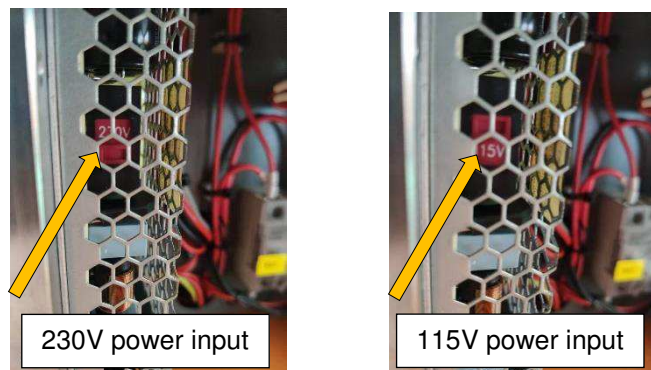
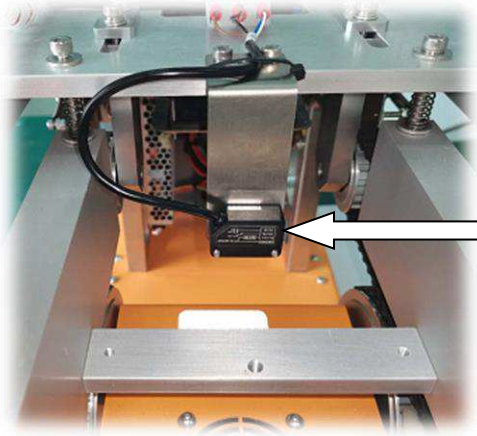

Fig.42 DC Power Supply (230V/115V switch)

## 7.9 Optical Parts Counter



*Fig.43 Photo Sensor (1PHTSENS)*

Through the photoelectric sensor detection, the signal will be transmitted to the PLC, by the PLC to complete the counting function.

- Use the object to pass under the photoelectric sensor. If the indicator light above the sensor changes, check its connection line with the PLC. If the indicator light doesn't change, the fault lies in the reflector or photo sensor.
- Inspect the reflector. If it is dirty, clean it using a damp soft cloth. If it is damaged, replace the reflector (TE PN: 5-2375314-4) .
- Place a piece of white paper under the photo sensor (over the reflector). A red-light beam should be visible. If it is not, replace the photo sensor.
- Sensor was assembled to locate in center as default, also it has additional mounting hole on left or right side. Customer can adjust it to sides if need. The reflector which attached on bottom of heat channel, should also be adjusted accordingly.

## 8 Components and Repair

Follow the guidelines in Sections 8.1 through 8.9 for replacing the major components of the machine.



*If the machine is still inoperative after following all troubleshooting and repair procedures, please contact your local TE representative.*

### **DANGER!**



These procedures should be performed only by a qualified maintenance person. To minimize the risks of burns, electrical shock, or other injuries, all safety precautions must be observed.

To prevent electric shock, perform this work with power OFF. First turn off the Main Switch. Then unplug the power cord.

The heaters remain hot after the belts and fans stop moving. To avoid any burns or injury during maintenance, wait an additional 15 minutes after the normal cool down cycle is complete before beginning.

Do not attempt to bypass the Main Switch.

Do not attempt to bypass the emergency stop switch.



*When reassembling panels, be sure no wires are pinched between the outer panels and the inner frame, or an electrical short or blown fuse could result.*

To avoid machine damage, replace fuses only with new fuses of the original amperage, voltage, and type. For recommended values, see outside panel of electric electrical cabinet, Specifications, or the fuse labels.

To rotate the belts, or to check the voltages for heater output, you may reconnect the machine. Disconnect it again before resuming repair work.

## 8.1 Electrical cabinet

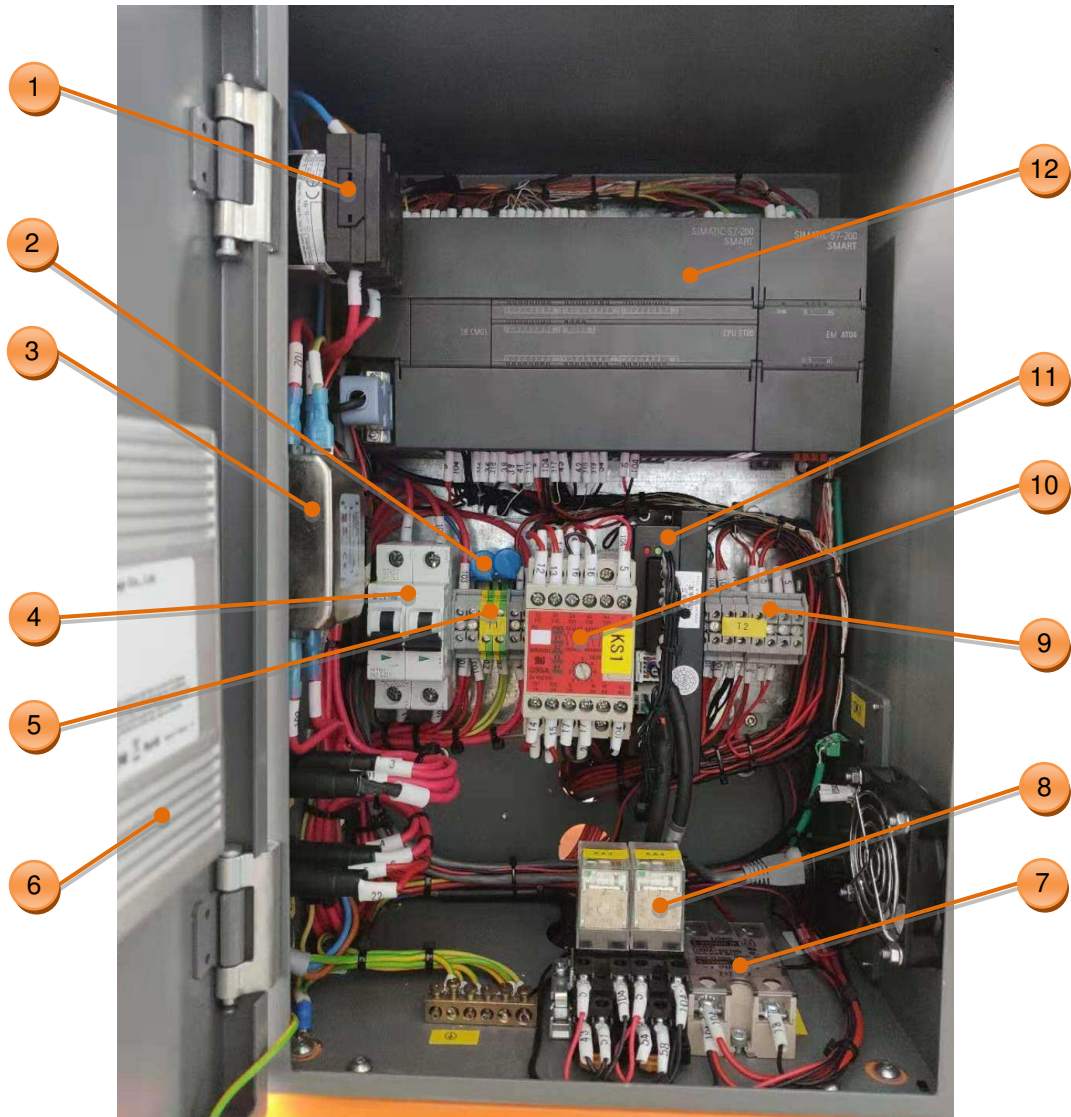

Fig.44 Electrical cabinet

- |  |  |
|--|--|
| 1. Main Switch QS1<br><i>Isolating the external power supply</i> | 2. Piezoresistor<br><i>Improve power supply quality</i>                          |
| 3. Filter FL<br><i>Filter particular frequency current</i>       | 4. Power switch QF1<br><i>Protect the machine from an electrical overload</i>    |
| 5. Terminal block T1<br><i>Connect the wires</i>                 | 6. HUB<br><i>Exchange the signal from PLC, HMI and external device</i>           |
| 7. Fan Relay KA2<br><i>Control the cooling fans</i>              | 8. Electrical Relay KA3 & KA4<br><i>Control the circuit</i>                      |
| 9. Terminal block T2<br><i>Connect the wires</i>                 | 10. Safety relay KS1<br><i>Control the safety action of machine, like E-stop</i> |
| 11. Stepper motor driver MD1<br><i>Control the motor</i>         | 12. PLC<br><i>Main controller of the machine</i>                                 |

## 8.2 Key components replacement

### 8.2.1 Belt Replacement



Fig.45 Drive belts

- When the machine is cool, turn OFF the Main Switch and unplug the power cord
- Remove all of the covers upper panel (for access to upper belts for replacement), both side panels, and lower front panel (for access to lower belts for replacement).
- Loosen the two tensioning screws located on the end of the front bearing stand.
- Remove the two screws on the rear of the belt guides to remove the lower belts.
- Remove the belts.
- Clean the pulley grooves. Use a wire-bristled brush to remove any dirt or adhesive buildup in the timing grooves.
- Check that the set screws are in place and secure in the drive pulleys and that the pulleys are aligned properly with the belt guides.
- Ensure that the bearings are secured to the bearing stands. They are secured with a bolt and nut through the stands.
- Inspect the foam pads and belt guides at this time. Replace as necessary.
- Install new belts by reversing the previous procedure (Steps 1-9)

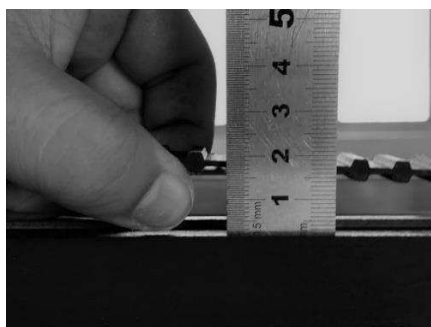

Fig.46 Measuring the Belt Tension

- Tension the belts by gripping the bearing stand and pulling forward. While keeping tension on the stand and belts, tighten the two locking, screws on the corresponding bearing stand.
- Replace and tighten the screws on the rear of the belt guides after replacing the lower belts.

- Measure the belt play by gripping the belt in the center and lightly pulling the belt away from the foam pad or belt guide. There should be a 17 mm (0.75 in) gap between the center of the belt and the foam pad or guide.



***Belts that are too tight will prematurely wear the bearings and stretch the belts.***

***Replace the upper timing belt with optional thin cable belt (Section 8.3.6), will allow the machine can carry thin cable. Assemble this thin cable belt, with big tooth towards outside track.***

Ensure that the upper backing rails are touching the upper belts. If they do not touch the belts, they may not securely grip smaller assemblies being processed.

Adjust the rails by using the spring -loaded screws at the end of the rails.

## 8.2.2 Heater Replacement

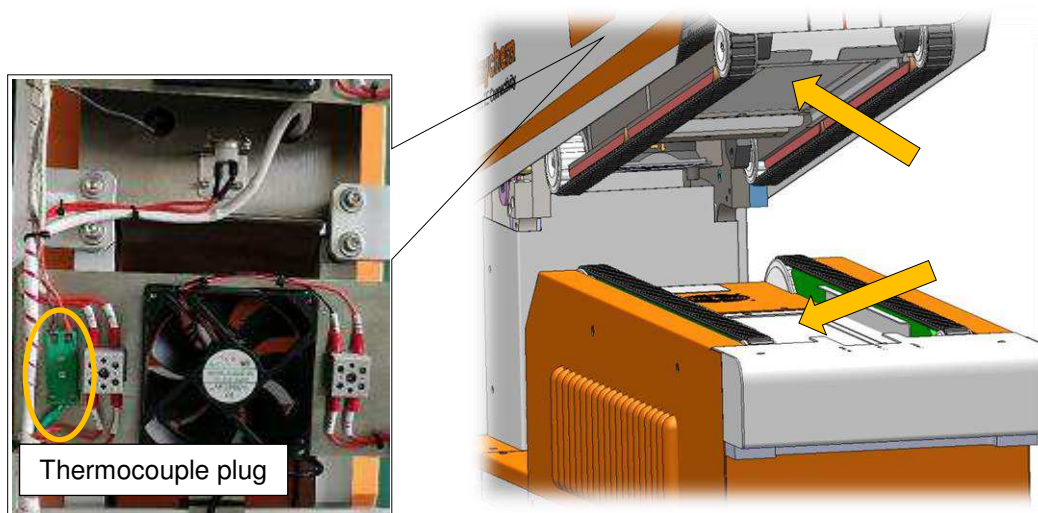

Fig.47 Heater

The machine has two heaters, one upper and one lower. The temperature is controlled through a K-type thermocouple embedded in the upper element. See section 2.1.1 specification, for the heaters spec.

For XB19 standard machine, allow to shift the heater to wider size heater, and the distance between left and right belt can be adjust wider accordingly. For assistance, contact your local TE representative.

- Remove the two mounting screws securing the heaters to the baffles.
- Remove top cover and disconnect the power leads by loosening the screws on the terminal block.
- Disconnect the thermocouple mini plug (Left picture in Fig.47 ) when replacing the upper heater
- Remove the heater.
- Install a new heater by reversing the procedure.



**Calibration is need after heater replacement.**

### 8.2.3 Motor driver Replacement



Fig.48 Motor driver

- Switch the Main Switch to OFF position and unplug the power cord
- Open the electrical cabinet cover.
- Remove the motor driver cover standoffs.
- Remove all wires from the controller. Note the position of the wires before removal.
- Remove the mounting screws from the controller.
- Set the dial switch above the new drive.
- Install a new controller by reversing the above procedure.

### 8.2.4 Idler Pulley and Bearing Replacement

The bullets come already pressed into the sealed needle bearings. They are replaced as a set, pulley and bearing.

- Remove the nut that secures the bolt to the bearing into the stand.
- Remove the pulley and bearing assembly from the stand and replace the entire unit. Do not try to separate the bearing from the pulley. The bearing is pressed into the pulley hub and is replaced as one unit.

### 8.2.5 Drive Pulley Replacement

- Remove the side covers.
- Mark the position of the pulley on the shaft. The pulley must be reinstalled in exactly the same position on the shaft as the old pulley.
- Loosen the 2 sets of screws in the pulley.
- Slide the pulley off the shaft, ensuring that the key is not lost.
- Slide the new pulley onto the shaft and locate it in the exact same position as the old pulley.
- Install the key and tighten the set screw

### 8.2.6 PLC or HMI replacement

ONLY WHEN PLC or HMI was replaced, it would require to do additional setting to below items.

To enter the current interface, you need the password with the highest authority (please contact the local field service engineer to obtain the password).



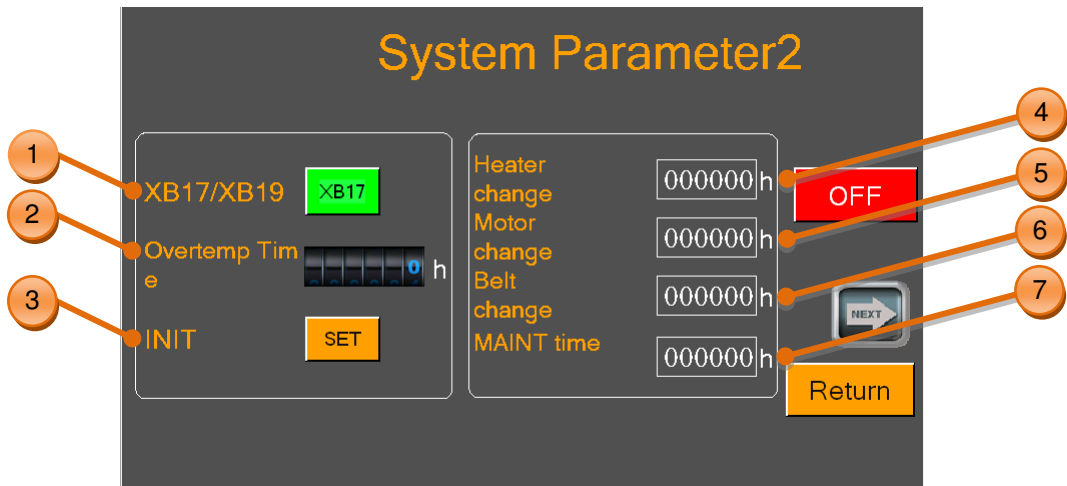

- |   |   |
|---|---|
| <p>1. XB17/XB19<br/><i>Refer to nameplate to select the right model of machine.</i></p> <p>3. INIT<br/><i>Initial all the parameters.</i></p> <p>5. Motor change<br/><i>Time of motor replacement.</i></p> <p>7. MAINT time<br/><i>Time of maintenance.</i></p> | <p>2. Overtemp Time<br/><i>Time when the temperature of the heater exceeds 550 °C</i></p> <p>4. Heater change<br/><i>Time of heater replacement.</i></p> <p>6. Belt change<br/><i>Time of belt replacement.</i></p> |
|---|---|

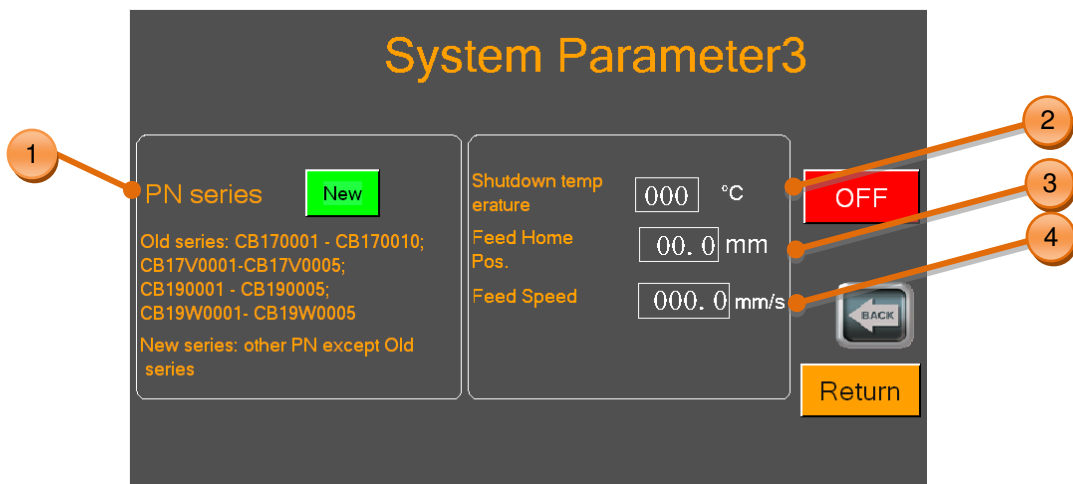

- |   |  |
|---|--|
| <p>1. PN series<br/><i>Select new or old according to the prompts below.</i></p> <p>3. Feed Home Pos<br/><i>Set the initial feeding position of the Centering Device according to the actual materials.</i></p> | <p>2. Shutdown temperature<br/><i>Below this temperature, machine will shut OFF automatically, default value is 200 °C.</i></p> <p>4. Feed speed<br/><i>Set the feeding speed of the Centering Device according to the actual materials.</i></p> |
|---|--|

### 8.3 Optional Accessories

Below option components were not included in standard machine. Customers need to purchase from TE separately IF NEED. **Please consult with representative for PN on TBD item.**

#### 8.3.1 Custom tooling (PN TBD)

In case of special product, like stub splice, ring terminal, it would need custom tool to process in XB Belt Heater.

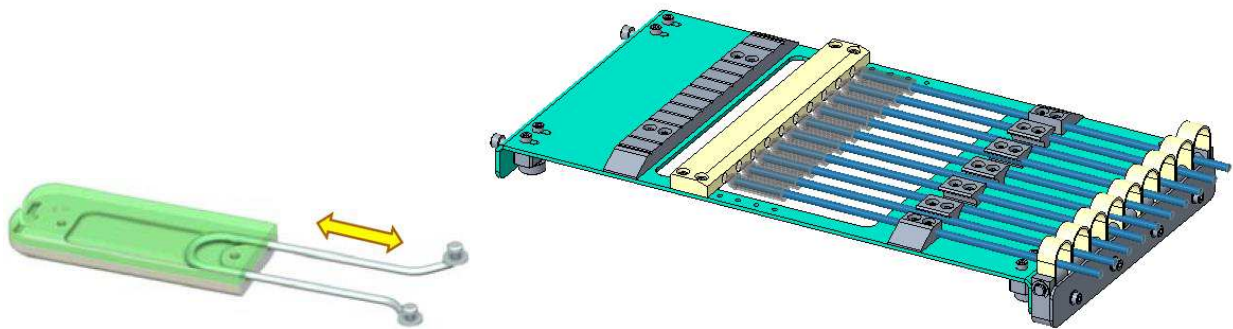

Fig.49 Custom tooling

#### 8.3.2 Floorstand (TE PN: 2375329-1)



Fig.50 Floorstand



Fig.51 Floorstand with Belt heater and Centering Device

### 8.3.3 Calibration tool

**Calibration tool:**

- UHI 250A probe. (TE PN: 7-1192190-9, ORDER-NO: 288869-000)
- Extension Cable. (TE PN: 9-2375314-6)
- Thermometer. (TE PN: 9-2375314-7)

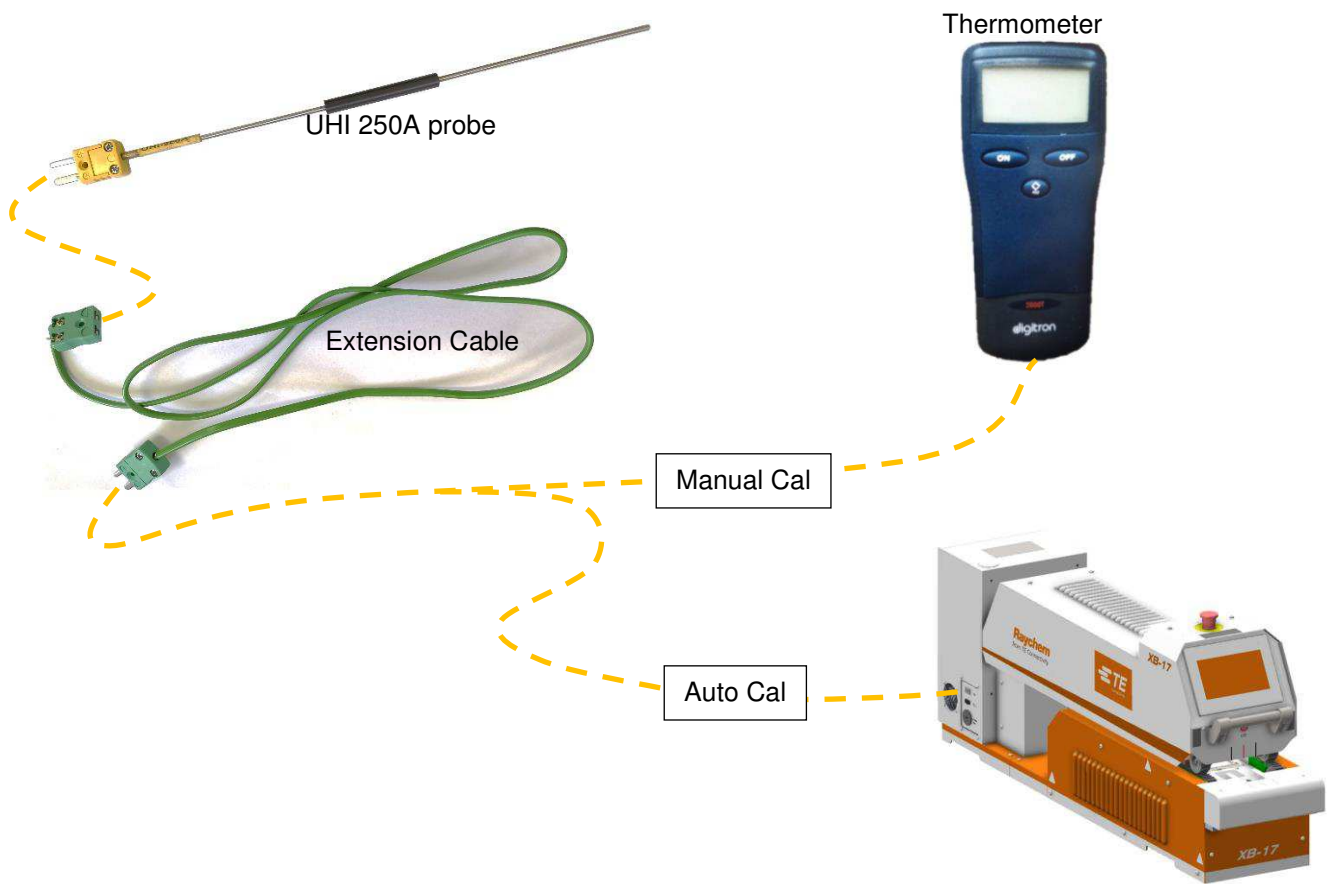

Fig.52 Calibration tool

### 8.3.4 Centering Device (TE PN: 2375330-1)

The Centering Device is an optional device that can be adopted to the XB Belt Heater in front. The Centering Device ensures the correct position of the heat shrink tube and the wire splice before feeding into heating chamber. See section 4.2.2, about how to operate machine with Centering Device.

Capacity: Max Tube length 110mm, Min cable length 450mm (excluding length to be caught by hands).

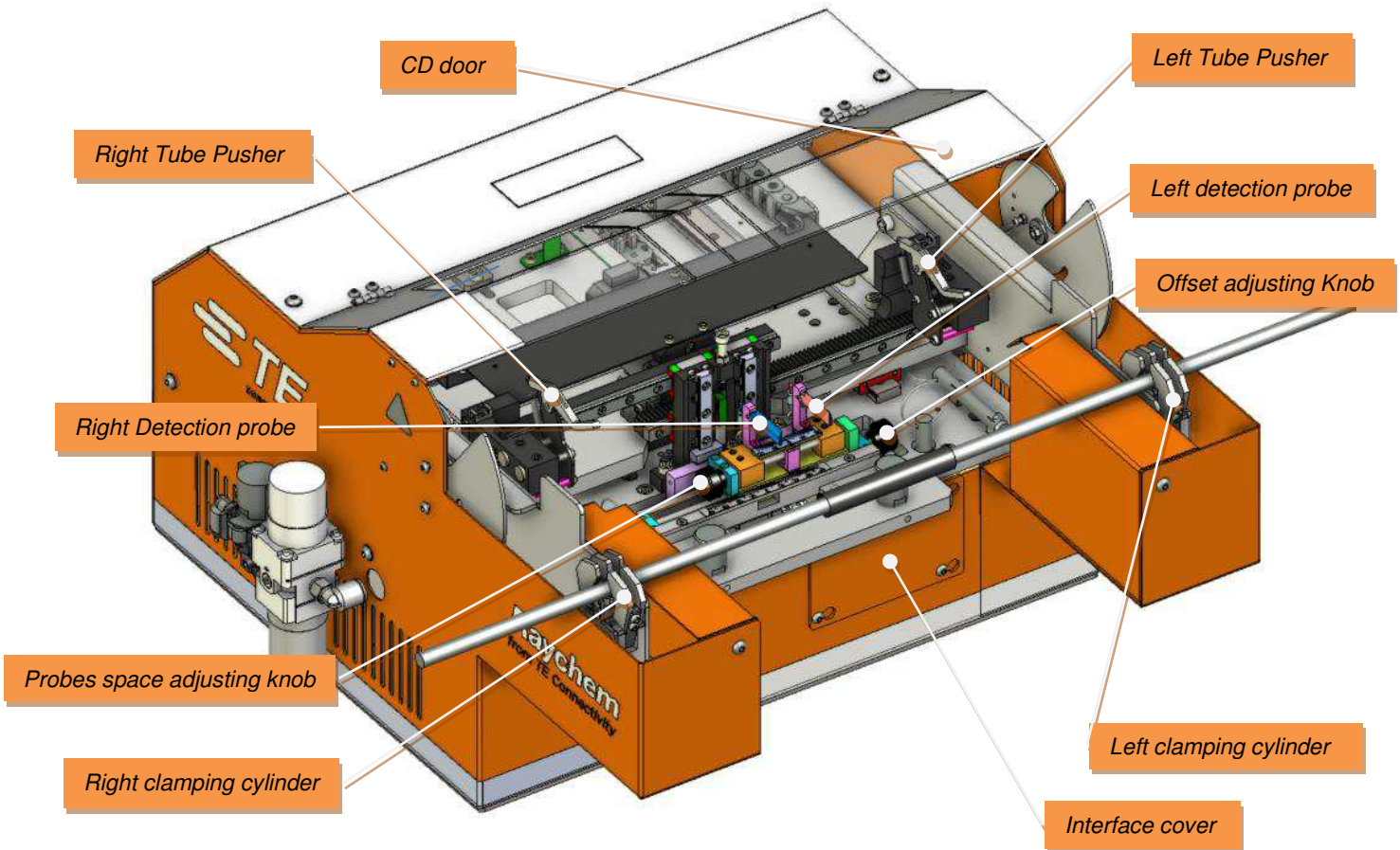

Fig.53 Centering Device

#### Installation:

- Remove the CD cover and Feed tray from the front of machine.
- Connect the Centering Device communication cable and power cord with machine CD interface.
- Refer to Fig.55, assemble CD onto machine front and fix it by 2X alignment pins.
- Refer to Fig.56, install the CD safety guard onto top chamber and fix it by 6X set screws.
- Connect the air supply.
- Activated Centering Device by switching on “CD switch” in HMI maintenance page.
- Then operator can see the detection unit moving up to detection position, and centering plate trying to find the original position. In touch panel, it appears the Centering icon on page top.
- Then Centering Device is ready for production.

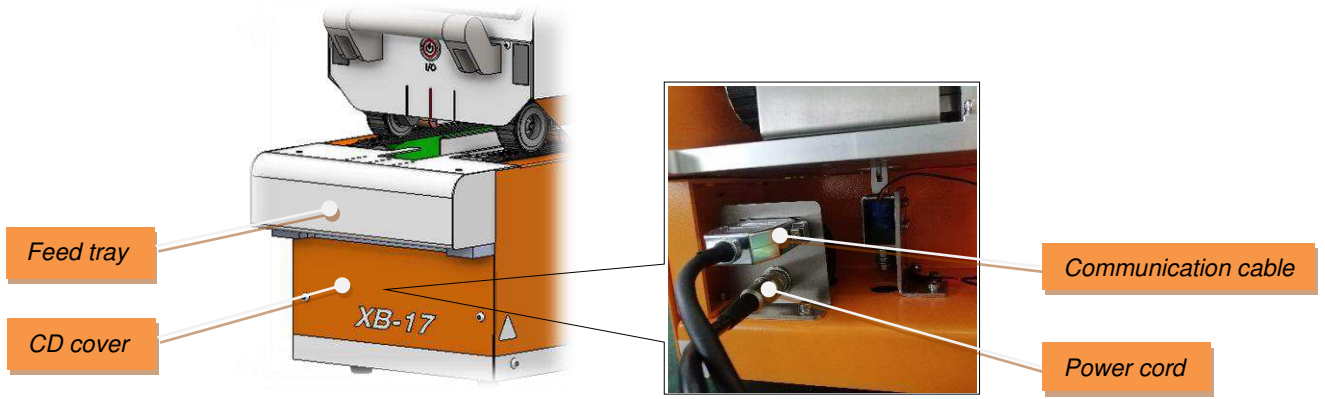

Fig.54 Machine CD interface

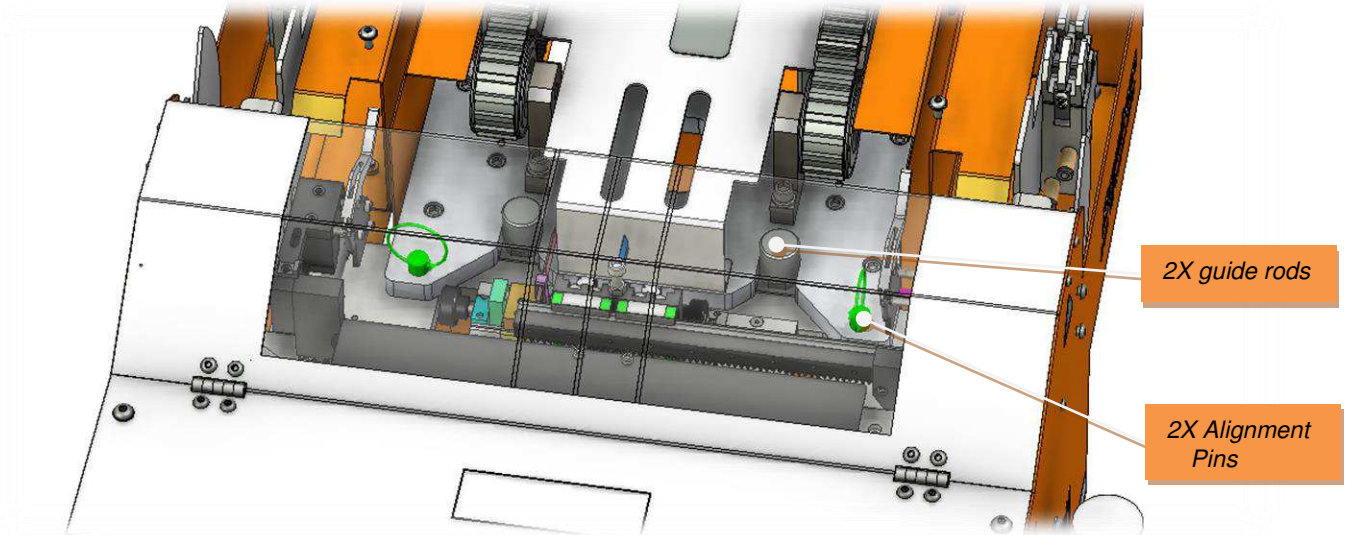

Fig.55 CD connect interface

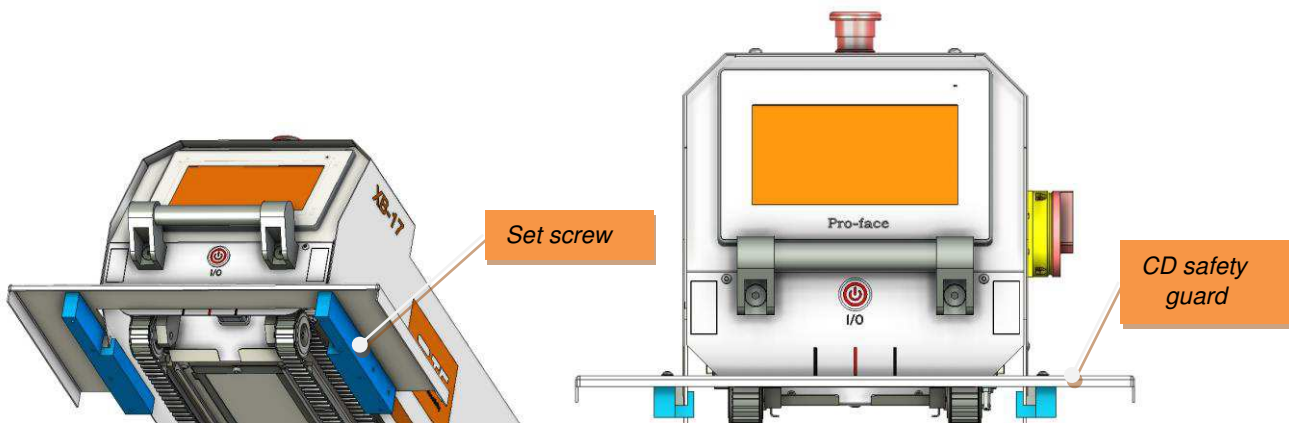

Fig.56 CD safety guard

8.3.5 Lockout gate (TE PN: 2375311-6)

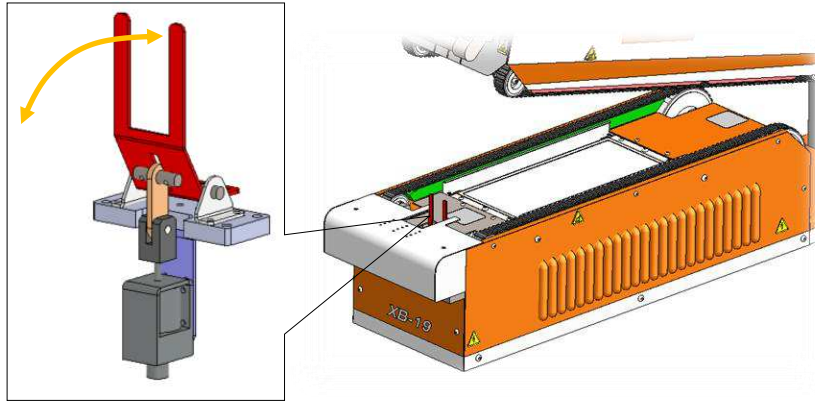

Fig.57 Lockout Gate

Optional mechanism, with same function as Reverse. Lockout gate will rise when beyond preset temperature range, preventing feeding new product. Standard Machine already have timing belt reverse function. Operators need to shift lockout gate or reverse accordingly in HMI maintenance page when trying to activate Lockout Gate. See section 5.5, item 4.

8.3.6 Other accessories

<b>9-2375314-9</b>	<b>Barcode Scanner, wireless</b>
<b>9-2375314-8</b>	<b>Light Tower</b>
<b>2-2375314-0</b>	<b>Upper timing belt, thin cable, XB17</b>
<b>2375324-2</b>	<b>Upper timing belt, thin cable, XB19</b>
<b>2234787-1</b>	<b>RS232 connection cable, ultrasonic</b>
<b>2234787-2</b>	<b>RS232 connection cable, ultrasonic, with adapter (NON-CE)</b>
<b>2234787-3</b>	<b>RS232 connection cable, ultrasonic, with adapter (CE)</b>









Ultrasonic RS232 connection cable 2234787-1 cannot used on XB17C or XB19C directly. Without connecting with an adapter, it has risk cause short cut issue to Centering Device.





8.4 Spare Parts

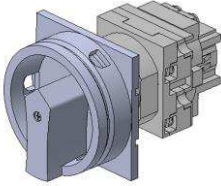
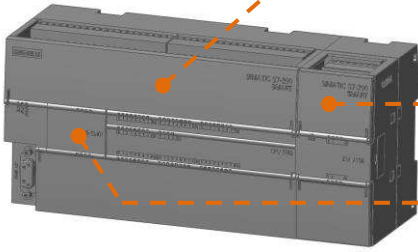

Description	Picture	Part No	Note
I/O button		1-2375314-5	See Fig.2, item 8
E-stop button		3-2375314-3	See Fig.2, item 5
Touch panel		3-2375314-2	See Fig.2, item 6
USB port		2-2375314-5	See Fig.2, item 4
FAN		1-2375314-2 1-2375314-3 5-2375314-5	Top chamber BTM chamber Cooling zone
Photoelectric sensor		4-2375314-2	2X in top chamber See Fig.43
Reflector, photoelectric sensor		5-2375314-4	Loc under photoelectric sensor. See Fig.43
Thermostat		4-2375314-9	See Fig.35

<b>Description</b>	<b>Picture</b>	<b>Part No</b>	<b>Note</b>
<b>XB17 Heater, 220V</b> (Machine 2375310-1)		<b>2375317-3</b>  <b>2375317-4</b>	<b>Upper heater</b>  <b>Lower Heater</b>
<b>XB17 Heater, 110V</b> (Machine 2375310-2)		<b>2375317-5</b>  <b>2375317-6</b>	<b>Upper heater</b>  <b>Lower Heater</b>
<b>XB19 Heater, STD</b> (Machine 2375320-1)		<b>2375327-3</b>  <b>2375327-4</b>	<b>Upper heater</b>  <b>Lower Heater</b>
<b>XB19 Heater, Wider</b> (Machine 2375320-2)		<b>2375327-5</b>  <b>2375327-6</b>	<b>Upper heater</b>  <b>Lower Heater</b>
<b>The micro switch</b>		<b>4-2375314-3</b>	<b>Rear side of top chamber</b>
<b>DC Power Supply</b>		<b>4-2375314-1</b>	<b>See Fig.41</b>
<b>Temperature controller</b>		<b>3-2375314-9</b>	<b>See Fig.34</b>
<b>Stepper Motor</b>		<b>6-2375314-7</b>	<b>BTM chamber</b> <b>See Fig.39</b>
<b>Motor driver</b>		<b>7-2375314-5</b>	<b>See Fig.44,</b> <b>item 11</b>

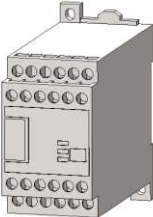
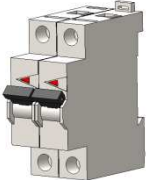

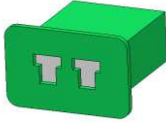
<b>Description</b>	<b>Picture</b>	<b>Part No</b>	<b>Note</b>
<b>Timing Belt, XB17</b>		<b>1-2375314-6</b>  <b>2-2375314-7</b>	<b>upper</b>  <b>lower</b>
<b>Timing Belt, XB19</b>		<b>2375324-1</b>  <b>2375324-4</b>	<b>upper</b>  <b>lower</b>
<b>Kit, foam pad, XB17</b>		<b>1-2375324-7</b>	<b>Press on upper timing belt</b>
<b>Kit, foam pad, XB19</b>		<b>2-2375324-1</b>	<b>Press on upper timing belt</b>
<b>Belt guide, XB17</b>		<b>3-2375312-3</b>	<b>BTM chamber</b>
<b>Belt guide, XB19</b>		<b>1-2375322-5</b>	<b>BTM chamber</b>
<b>Idler pulley</b>		<b>2-2375314-2</b>	
<b>Drive pulley</b>		<b>6-2375314-1</b>	

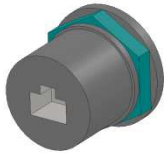
Description	Picture	Part No	Note
<b>Main switch</b>		<b>8-2375314-9</b>	<b>See Fig.44, item 1</b>
<b>PLC ASSY</b>		<b>8-2375314-3</b> CPU module, programmed  <b>6-2375314-9</b> Analog input module  <b>6-2375314-8</b> Communication module	<b>See Fig.44, item 12</b>
<b>HUB</b>		<b>7-2375314-3</b>	<b>See Fig.44, item 6</b>
<b>Safety relay</b>		<b>7-2375314-9</b>	<b>See Fig.44, item 10</b>
<b>Miniature circuit breaker</b>		<b>8-2375314-6</b>	<b>See Fig.44, item 4</b>
<b>Wave filter</b>		<b>8-2375314-5</b>	<b>See Fig.44, item 3</b>
<b>Thermocouple panel socket</b>		<b>7-2375314-6</b>	<b>See Fig.2, item 1</b>

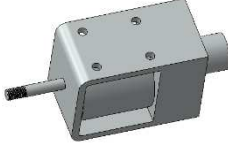
<b>Description</b>	<b>Picture</b>	<b>Part No</b>	<b>Note</b>
<i>Ethernet port</i>		<i>7-2375314-2</i>	<i>See Fig.2, item 3</i>
<i>D-sub 9 pin connector</i>		<i>8-2375314-2</i>	<i>See Fig.2, item 2</i>
<i>Compression spring</i>		<i>4-2375314-4</i>	<i>See Fig.31</i>
<i>electromagnet</i>		<i>5-2375314-1</i>	<i>See Fig.57</i>



## 9 Address "After" Sales

Tyco Electronics (Shanghai) Co., Ltd  
F/G/H Section, 1/F, Building 15, 999 Yinglun Road,  
(Shanghai) Pilot Free Trade Zone, China  
GATD Hotline: +86-021-33989030  
Email: [TEFE1AP@te.com](mailto:TEFE1AP@te.com)

# 10 Schematic Diagram

Note: (Belt Heater base machine, sheet 1~10. Centering Device, sheet 11~15)

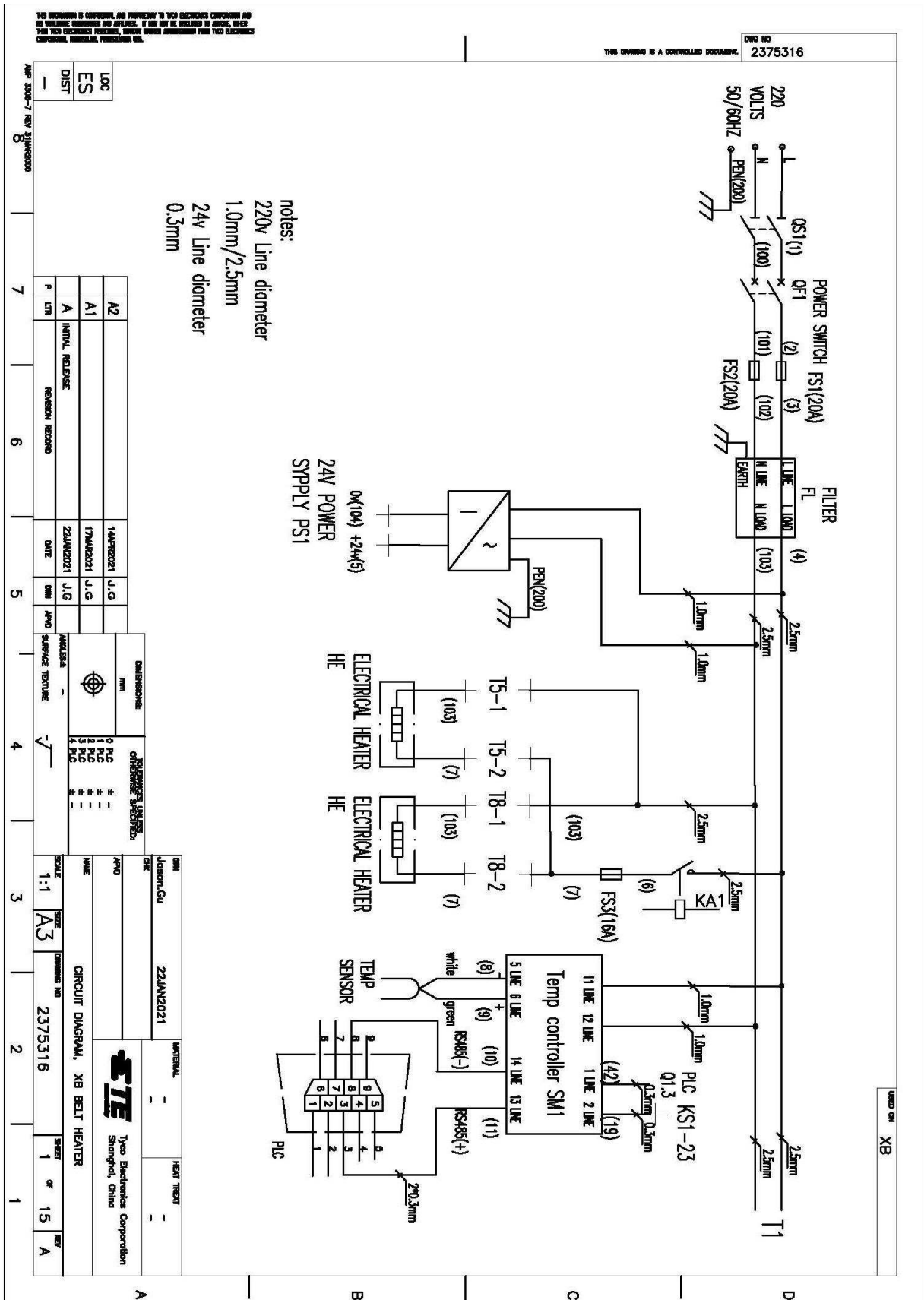

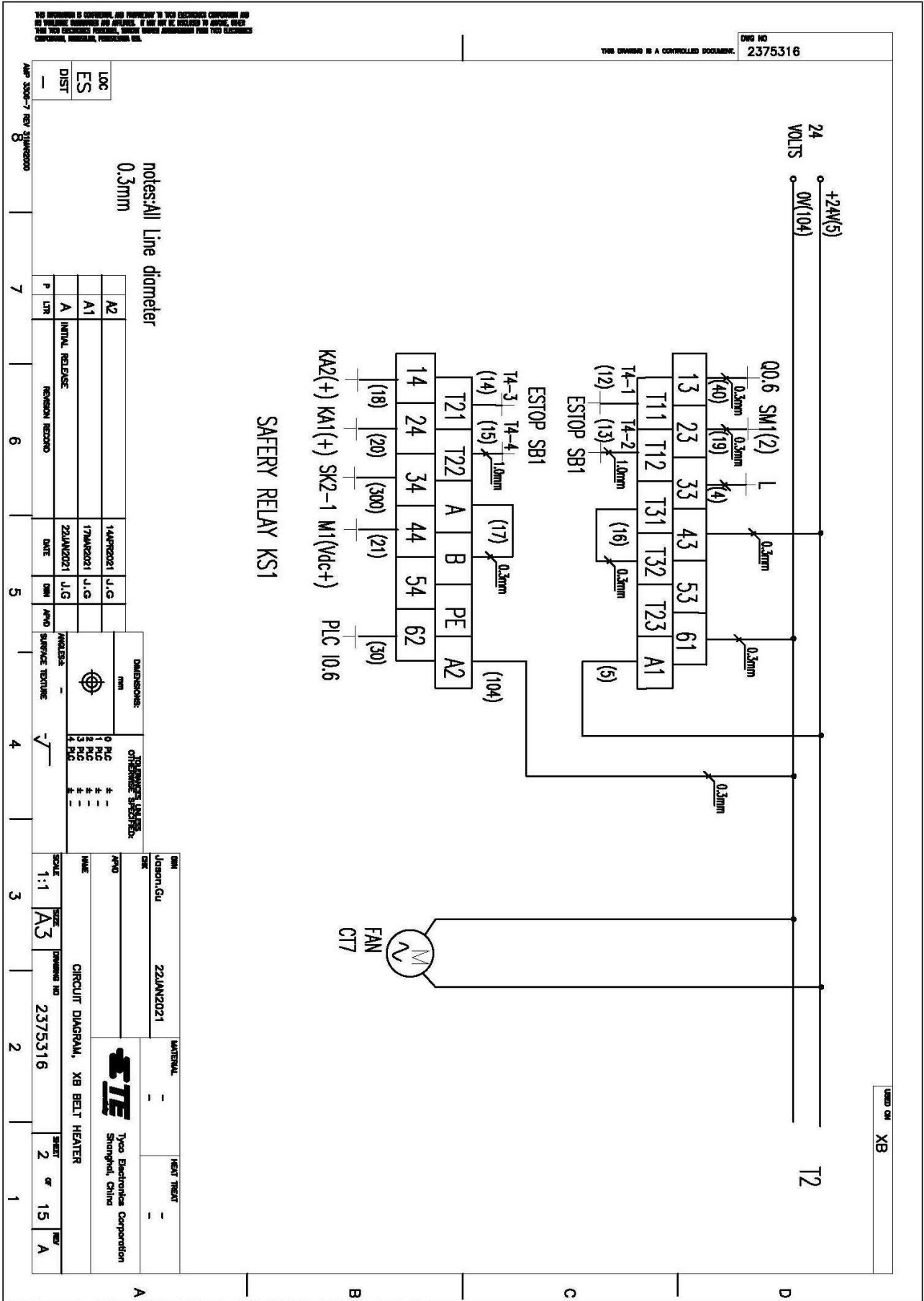

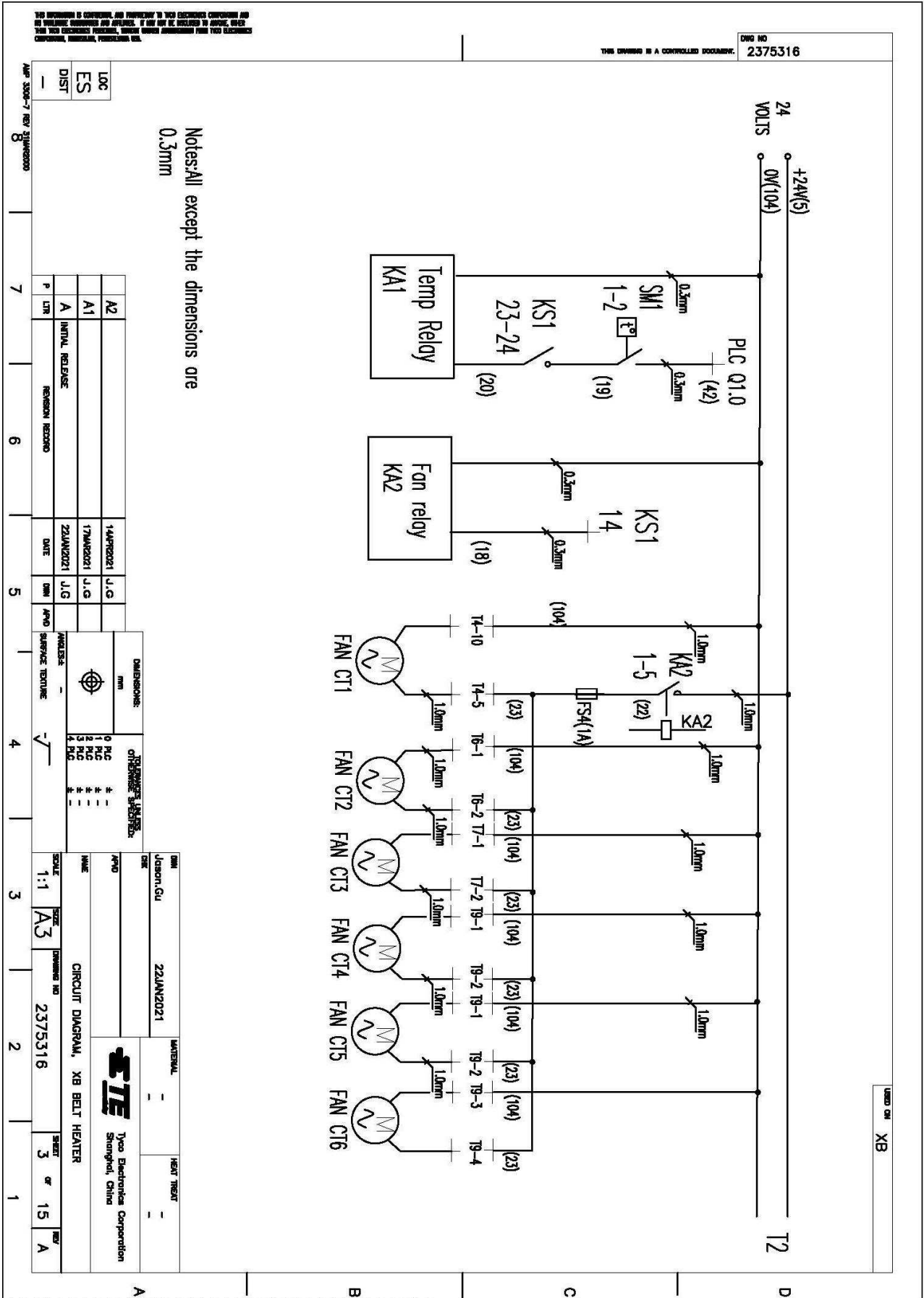





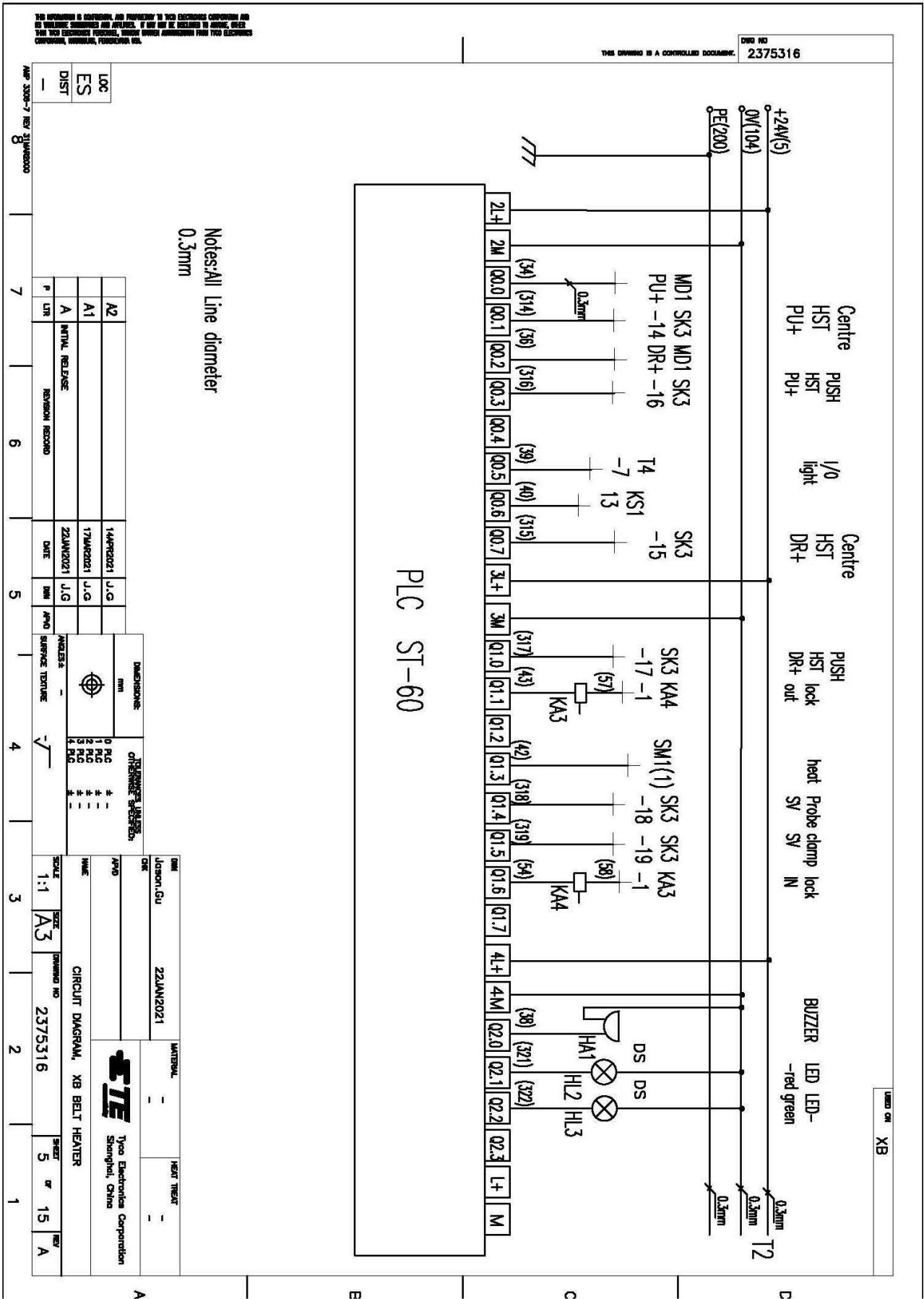



DWG NO 2375316  
 THIS DRAWING IS A CONTROLLED DOCUMENT.

notes: All Line diameter 0.3mm

LOC	ES	DIST	A2	A1	A	P	LTR	REVISION RECORD	DATE	DWG	APP'D	APPROVED	DIMENSIONS	OTHER SURFACE FINISHES	SCALE	SIZE	DRAWING NO	SHEET	OF	REV
—	—	—			INITIAL RELEASE				22JUN2021	J.G		—	0 R.G 1 R.G 2 R.G 3 R.G	1:1	A3	2375316	7	15	A	

DATE: 22JUN2021

DWG: J.G

APP'D: [Signature]

APPROVED: [Signature]

DIMENSIONS: [Symbol]

OTHER SURFACE FINISHES: [Symbol]

SCALE: 1:1

SIZE: A3

DRAWING NO: 2375316

SHEET: 7

OF: 15

REV: A

DATE: 14MAY2021

DWG: J.G

APP'D: [Signature]

APPROVED: [Signature]

DIMENSIONS: [Symbol]

OTHER SURFACE FINISHES: [Symbol]

SCALE: 1:1

SIZE: A3

DRAWING NO: 2375316

SHEET: 7

OF: 15

REV: A

USED ON: XB



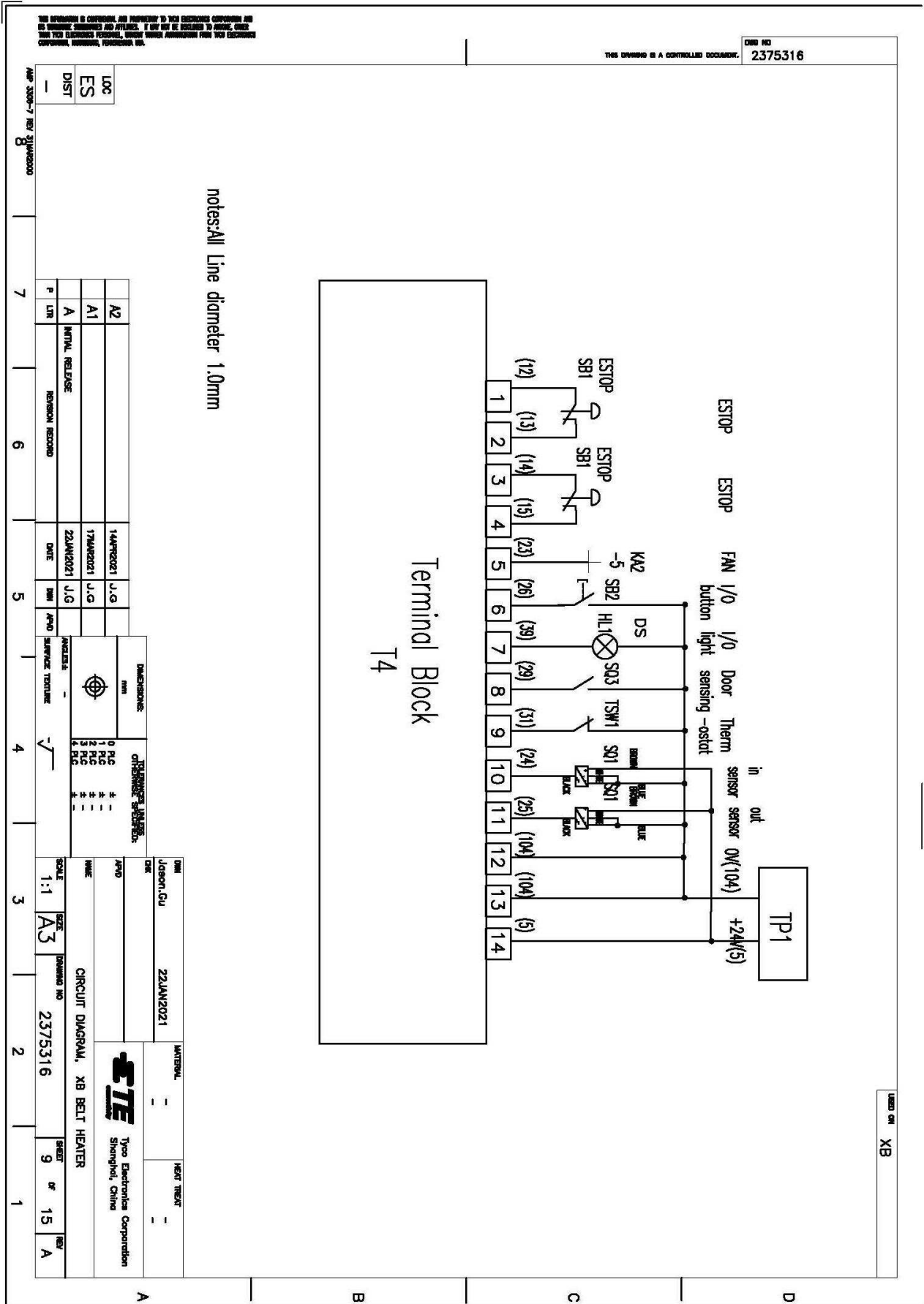



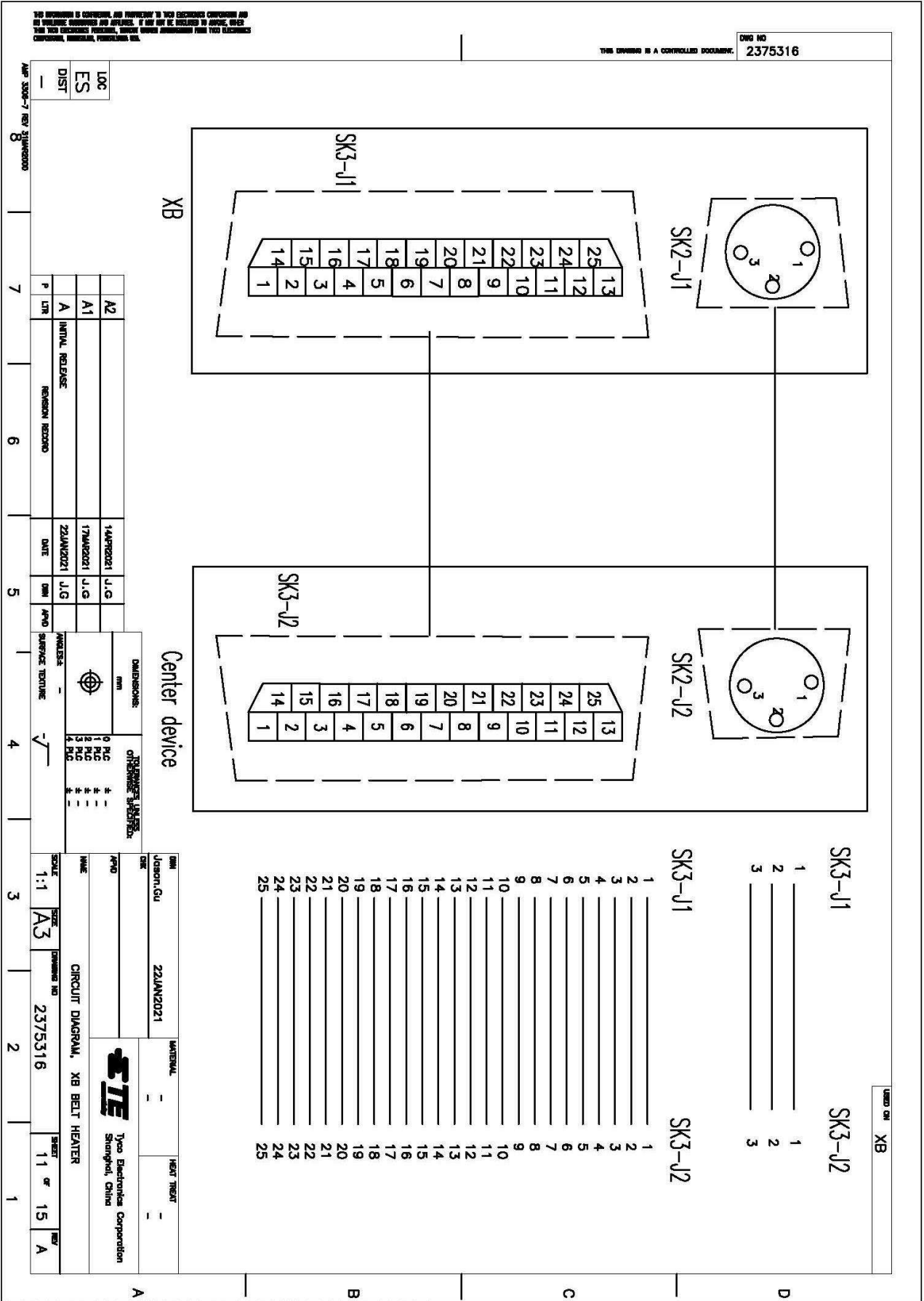

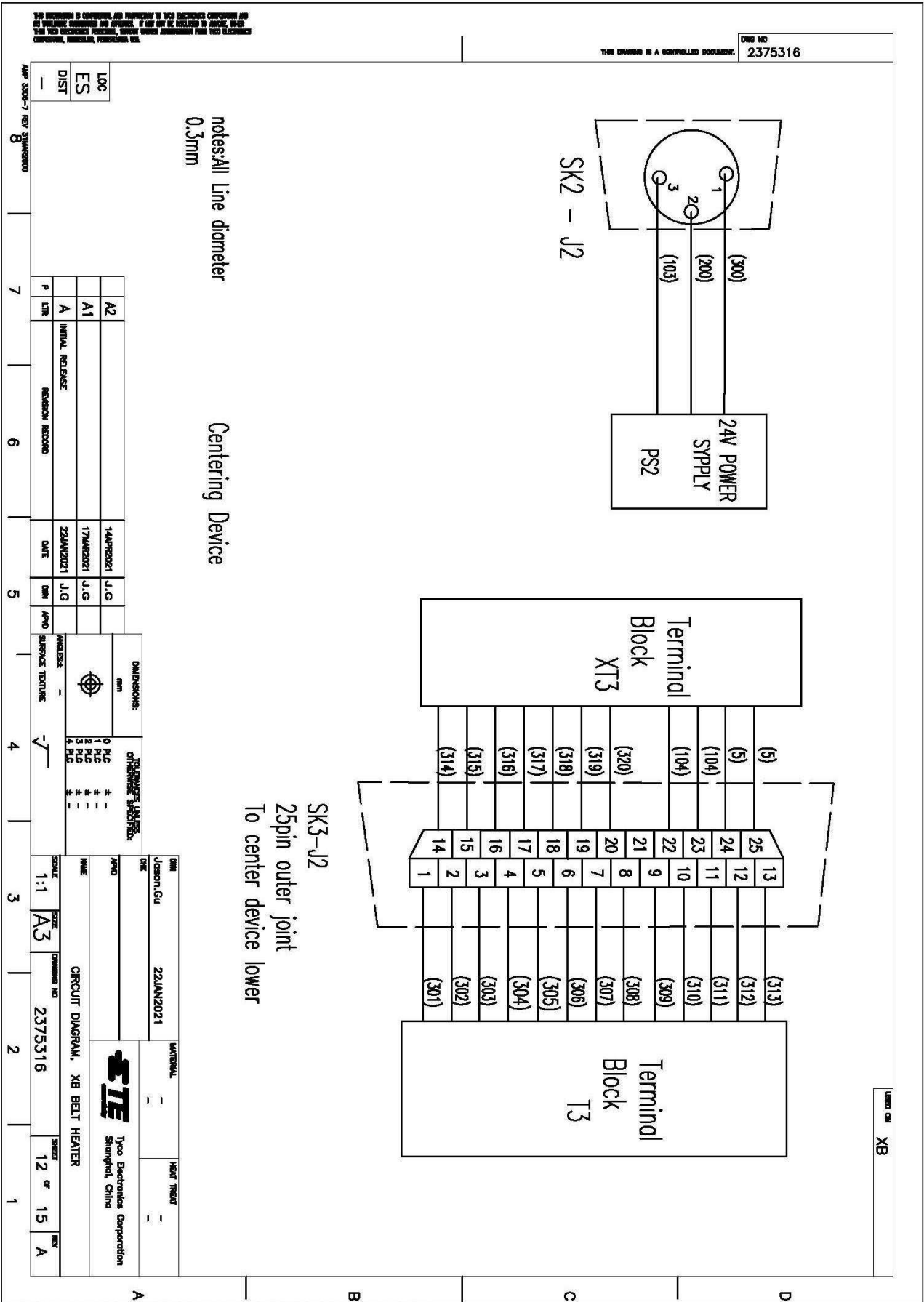



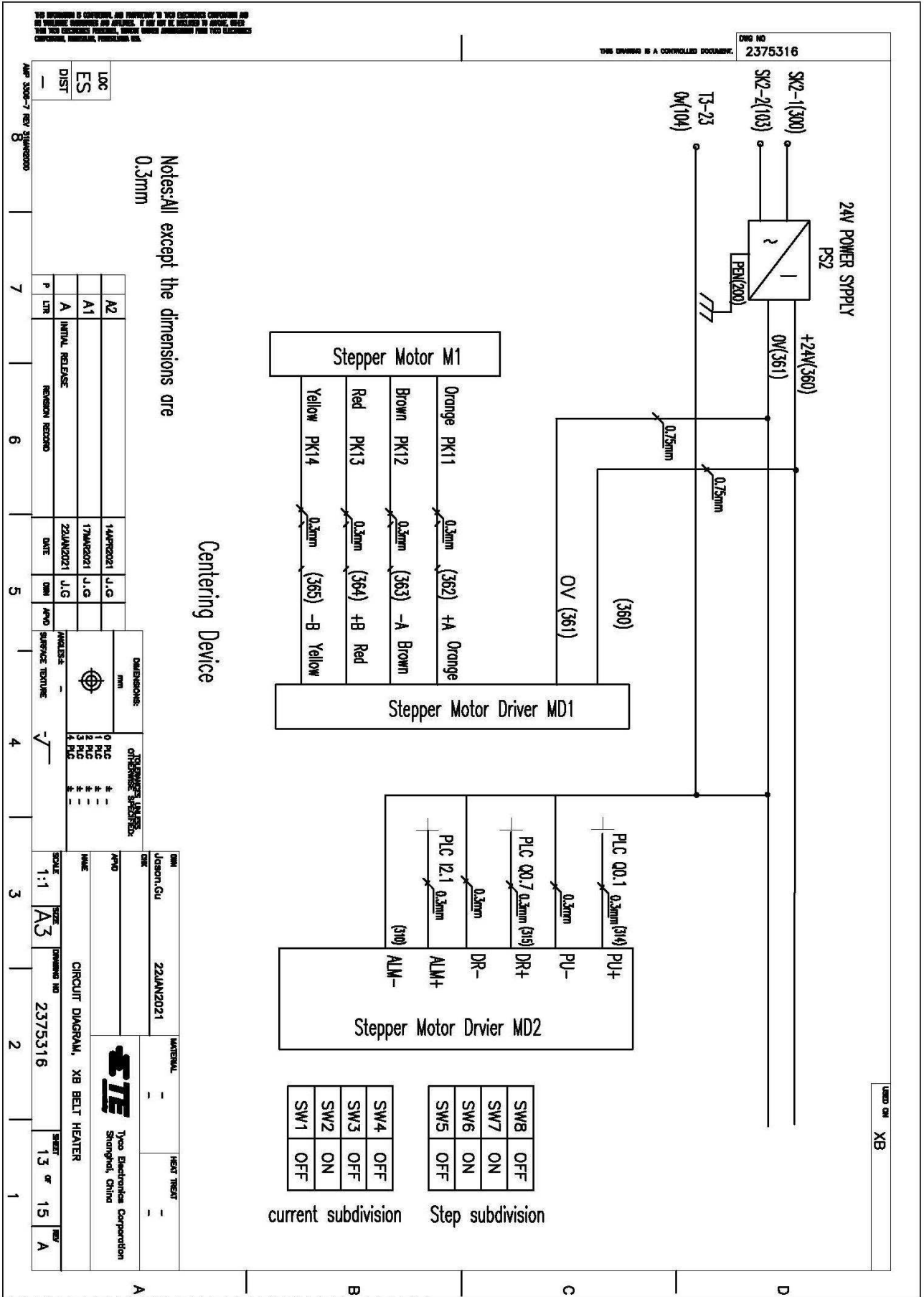

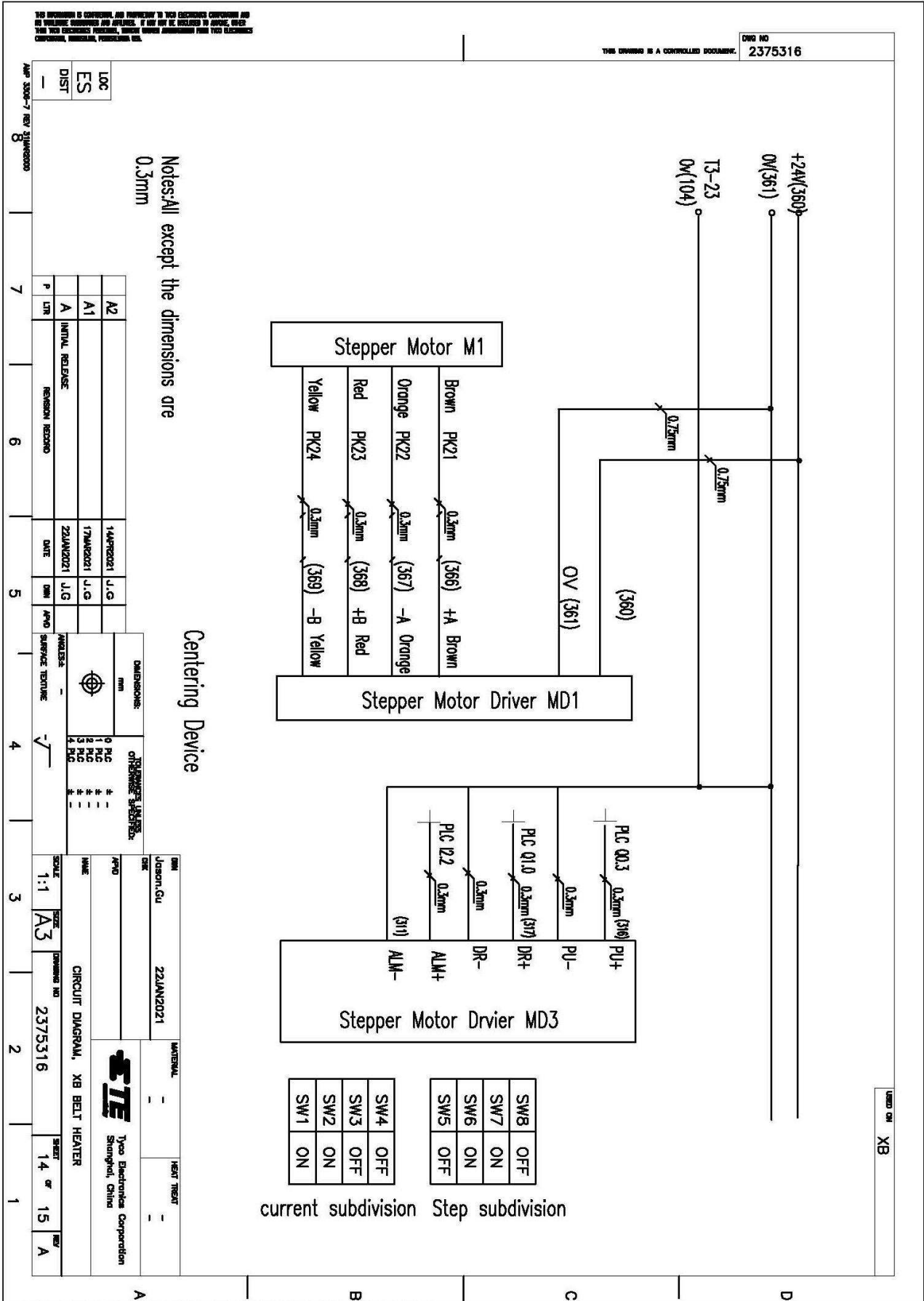

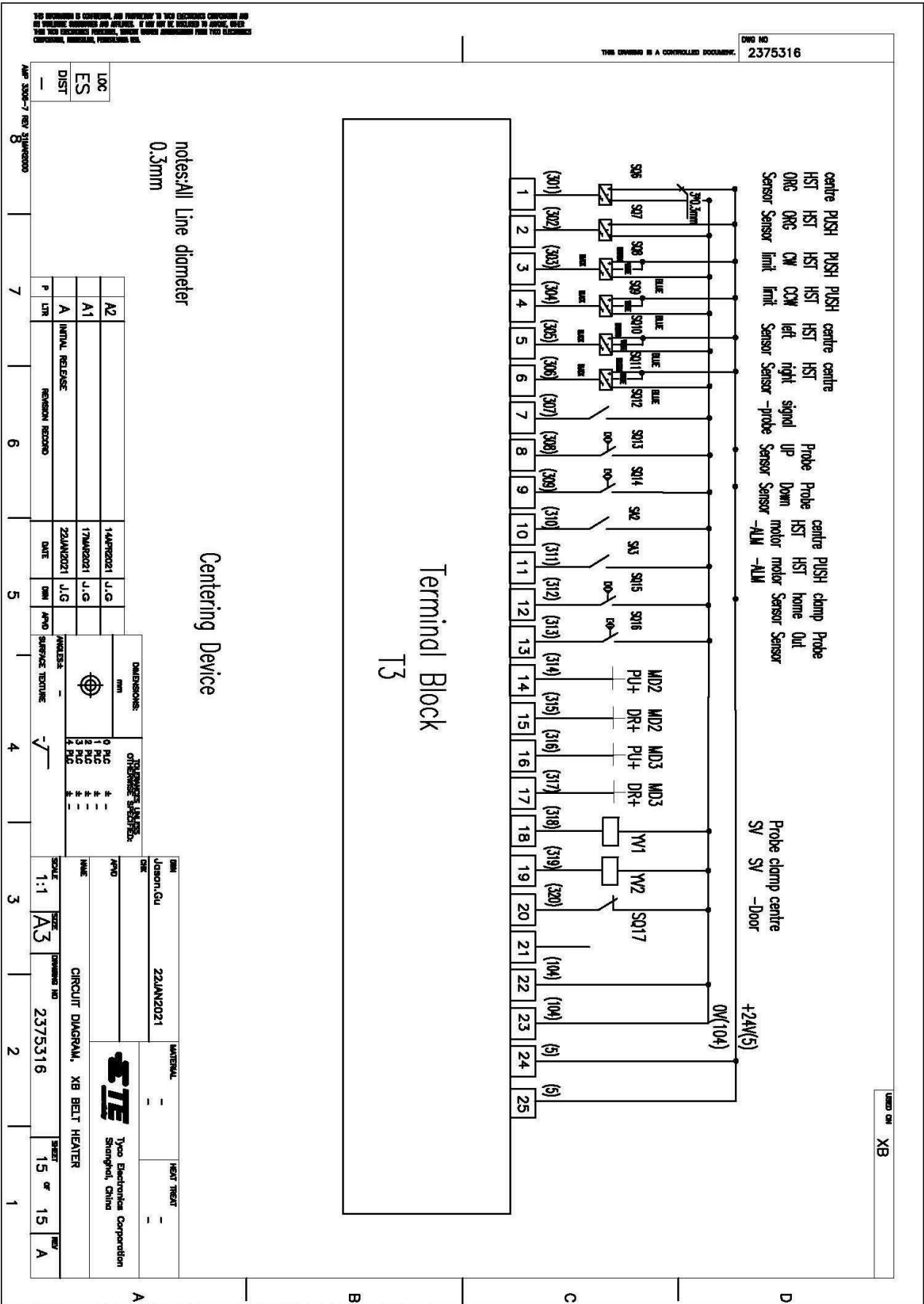

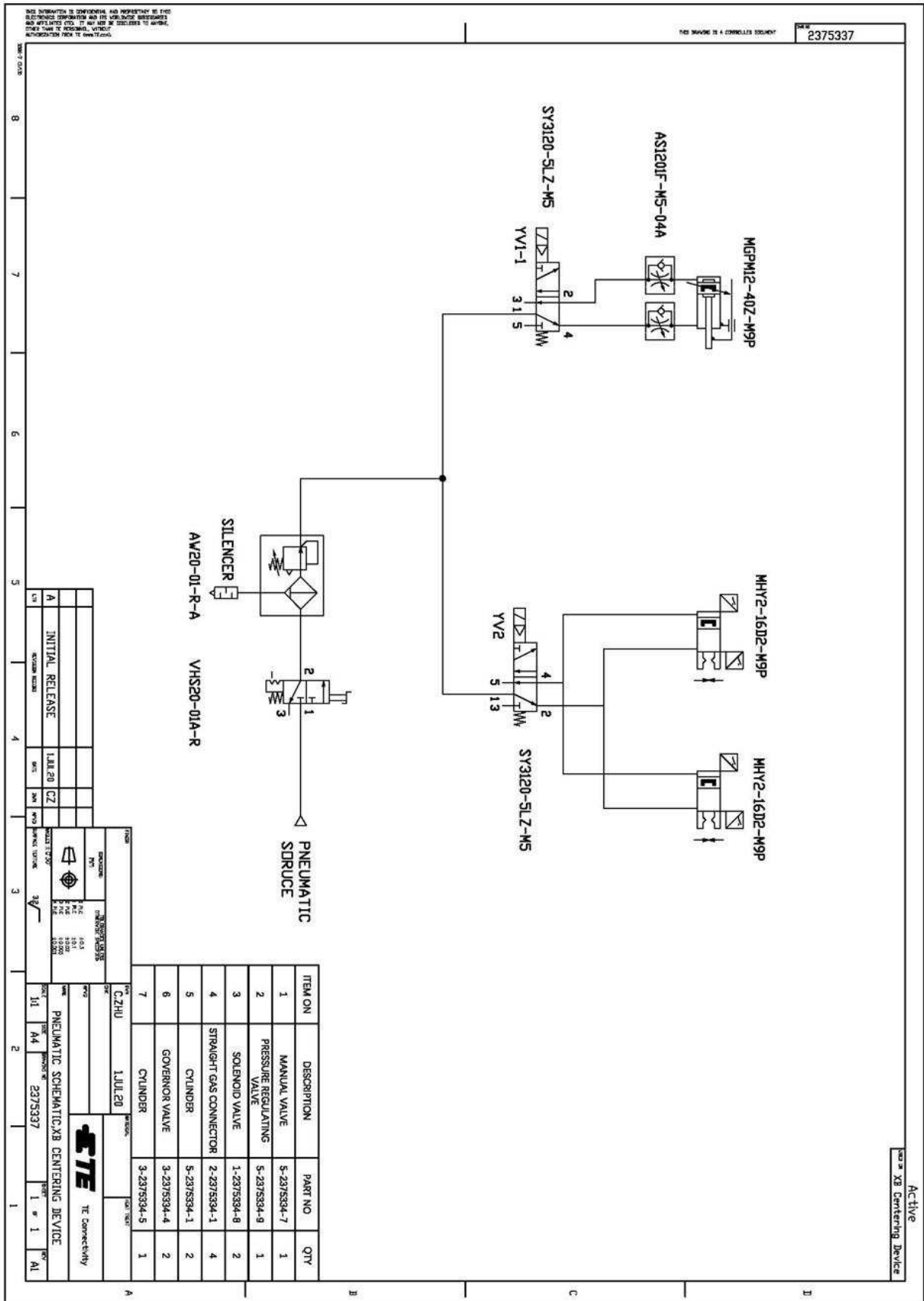

# 11 Pneumatic Diagram (Centering Device)



## 12 Declaration of conformity of CE

	<b>DECLARATION OF CONFORMITY</b>
Tyco Electronics (Shanghai) Co., Ltd. F/G/H Section, 1/F, Building 15, 999 Yinglun Road, (Shanghai) Pilot Free Trade Zone, China	
We declare that the machinery	
<b>XB17, XB19, XB17C, XB19C</b>	
Name, type or model	
<b>2375310-1, 2375310-2, 2375320-1, 2375320-2, 2381120-1, 2381130-1</b>	
Serial number or PN	
on the basis of the design and construction of the version issued by us for circulation is in conformity with the essential Health and Safety requirements of the following EC directives. Any modification made to the machinery without our approval shall invalidate this declaration.	
<ul style="list-style-type: none"><li>• Machinery Directive 2006/42/EC Annex I (EN ISO 12100:2010, EN 60204-1:2018)</li><li>• EMC Directive 2014/30/EU (EN IEC 61000-6-2:2019, EN IEC 61000-6-4:2019)</li></ul>	
The original English version is legally binding	
Name of the authorized Person for documentation:	
<b>TE Connectivity Germany GmbH</b>	
Address of the authorized Person for documentation:	
<b>AMPèrestraße 12-14, D-64625 Bensheim</b>	
<b>11/16/2020</b>	
<b>Middletown Pa. 17057 USA Robert Jakus, Quality Manager, Product Safety Compliance Officer</b>	
Place and date of issue	Name, position and signature
EN	