

customer manual

ORIGINAL INSTRUCTIONS

SAFETY PRECAUTIONS — READ THIS FIRST!	2
SAFETY PRECAUTIONS — AVOID INJURY — READ THIS FIRST!	3
1. INTRODUCTION	4
2. SAFETY	5
2.1.Standards	5
2.2.Ear and eye protection	5
2.3.Safety covers and guards	6
2.4.Power connections	6
2.5.Safety interlocks	11
2.6.Emergency stop switch	14
3. DESCRIPTION	15
3.1.Machine overview	15
3.2.Specifications	17
3.3.Major components	18
4. RECEIVING INSPECTION AND INSTALLATION	30
4.1.Receiving inspection	30
4.2.Installation	37
5. OPERATION	42
5.1.Overview	42
5.2.User interface	43
5.3.Initial startup	62
5.4.Processing	62
6. MAINTENANCE	75
6.1.Daily maintenance	75
6.2.Monthly maintenance	76
6.3.Tooling changeover	76
6.4.Preventive maintenance	85
7. TROUBLESHOOTING	85
8. REPLACEMENT AND REPAIR	86
8.1.Sensor replacement	87
9. DECOMMISSIONING	88
10. REVISION SUMMARY	88

SAFETY PRECAUTIONS — READ THIS FIRST!

IMPORTANT SAFETY INFORMATION

**NOTE**

Keep all decals clean and legible, and replace them when necessary.

**DANGER
ELECTRIC SHOCK HAZARD**

This tool is not insulated. When using this unit near energized electrical lines, use proper personal protective equipment.



Failure to observe this warning could result in severe injury or death.

**DANGER
SKIN INJECTION HAZARD**

Do not use hands to check for oil leaks. Highly pressurized oil punctures the skin, causing serious injury, gangrene, or death. If injured, seek immediate medical help to remove the oil.

**DANGER
FIRE HAZARD**

Do not use solvents or flammable liquids to clean the crimping tool. Solvents or flammable liquids could ignite and cause serious injury or property damage.



Failure to heed these warnings could result in severe injury from harmful fumes or burns from flying debris.

**DANGER**

Inspect the tool and jaws/dies before each use. Replace any worn or damaged parts. A damaged or improperly assembled tool can break and strike nearby personnel.

Failure to observe this warning could result in severe injury or death.

**CAUTION**

— Do not place the tool in a vise. The crimping tool is designed for hand-held operation.

— Protect the crimping tool from rain and moisture. Water damages the crimping tool and battery.

Failure to observe these precautions can result in injury or property damage.

**CAUTION**

— Do not perform any service or maintenance other than as described in this manual. Injury or damage to the tool can result.

Failure to observe these precautions can result in injury or property damage.

SAFETY PRECAUTIONS — AVOID INJURY — READ THIS FIRST!

Safeguards are designed into this application equipment to protect operators and maintenance personnel from most hazards during equipment operation. However, certain safety precautions must be taken by the operator and repair personnel to avoid personal injury, as well as damage to the equipment. For best results, application equipment must be operated in a dry, dust-free environment. Do not operate equipment in a gaseous or hazardous environment.

Carefully observe the following safety precautions before and during operation of the equipment:



Always wear approved eye protection while operating equipment.



Never insert hands into installed equipment. Never wear loose clothing or jewelry that can catch in moving parts of the equipment.



Always wear appropriate ear protection while using equipment.



Never alter, modify, or misuse the equipment.



Moving parts can crush and cut. Always keep guards in place during normal operation.



Do not operate equipment if the guards are removed.



Electrical shock hazard.



Read and understand this entire document before using equipment.



Always turn off the main power switch and disconnect the electrical cord from the power source when performing repair or maintenance on the equipment.

SUPPORT CENTER

CALL TOLL FREE 1-800-522-6752 (CONTINENTAL UNITED STATES AND PUERTO RICO ONLY)

Canada: 1.800.522.6752

China: +86.400.820.6015

Mexico: +52.55.1106.0800

Latin/South America +54.11.4733.2200

Germany: +49.6151.607.1999

UK: +44.0800.267666

France: +33.1.34.20.8686

Netherlands: +31.73.624.6999

The **Support Center** offers a means of providing technical assistance when required. In addition, Field Service Specialists are available to provide assistance with the adjustment or repair of the application equipment when problems arise which your maintenance personnel are unable to correct.

INFORMATION REQUIRED WHEN CONTACTING THE SUPPORT CENTER

When calling the Support Center regarding service to equipment, it is suggested that a person familiar with the device be present with a copy of the manual (and drawings) to receive instructions. Many difficulties can be avoided in this manner.

When calling the Support Center, be ready with the following information:

- Customer name
- Customer address
- Person to contact (name, title, telephone number, and extension)
- Person calling
- Equipment number (and serial number if applicable)
- Product part number (and serial number if applicable)
- Urgency of request
- Nature of problem
- Description of inoperative components
- Additional information or comments that can be helpful

Figure 1: High Voltage Cable Preparation machine



- 1** Left side
- 2** Right side
- 3** Front

1. INTRODUCTION

This manual contains the safety, installation, setup, operation, and maintenance procedures for the TE Connectivity High Voltage Cable Preparation (HV-CP) machine; part number 2335400-1 (Figure 1). Throughout this manual the left, right, and front side of the machine are defined as shown in Figure 1.

The HV-CP is a semi-automatic, programmable, stand-alone machine designed to strip the cable jacket, braid, and dielectric foil from round, multi-layer cables (Figure 2) in preparation for the application of crimped terminals.

Figure 2: Stripping a cable



The machine can process cables with conductor cross-sectional areas ranging from 10mm² to 120mm², (8.8mm to 23mm outside diameter).

The machine and tooling have been designed to allow the processing of many cable types and sizes.

2. SAFETY

When reading this manual, pay particular attention to DANGER, CAUTION, and NOTE statements.



DANGER

Denotes an imminent hazard that can result in moderate or severe injury.



CAUTION

Denotes a condition that can result in product or equipment damage.



NOTE

Highlights special or important information.

2.1. Standards

The HV-CP machine is designed to comply with the following standards:

- [European Machinery Directive 2006/42/EC](#)
- [European EMC Directive 2014/30/EU](#)

2.2. Ear and eye protection



Always wear approved eye and ear protection while operating equipment.

The following applies to the sound level produced by the HV-CP machine:

- The sound pressure levels at the operator position are at the infeed < 69.3 dBA, uncertainty K is 6.3 dBA.
- The sound power level is 74.0 dBA, uncertainty K, 7.4 dBA.



NOTE

Operating conditions and procedures during sound testing are in accordance with EN 1218-4:2004 + A2:2009. Sound pressure level at the operator position have been measured in accordance with EN ISO 11202:2010. The sound power level has been determined in accordance with EN ISO 3746:2010. Uncertainty has been determined in accordance with EN ISO 4871:2009.

2.3. Safety covers and guards



DANGER

Operating the machine with missing or removed components can result in moderate or severe injury, including death.



DANGER

Moving parts can crush and cut.



DANGER

Do not operate the equipment without guards in place.

All safety guards and doors must be in place and securely closed before operating the machine.

2.4. Power connections

A. Main electrical power disconnect

The main electrical power disconnect switch is located on the left side of the machine (Figure 3).

Figure 3: Main electrical power disconnect switch

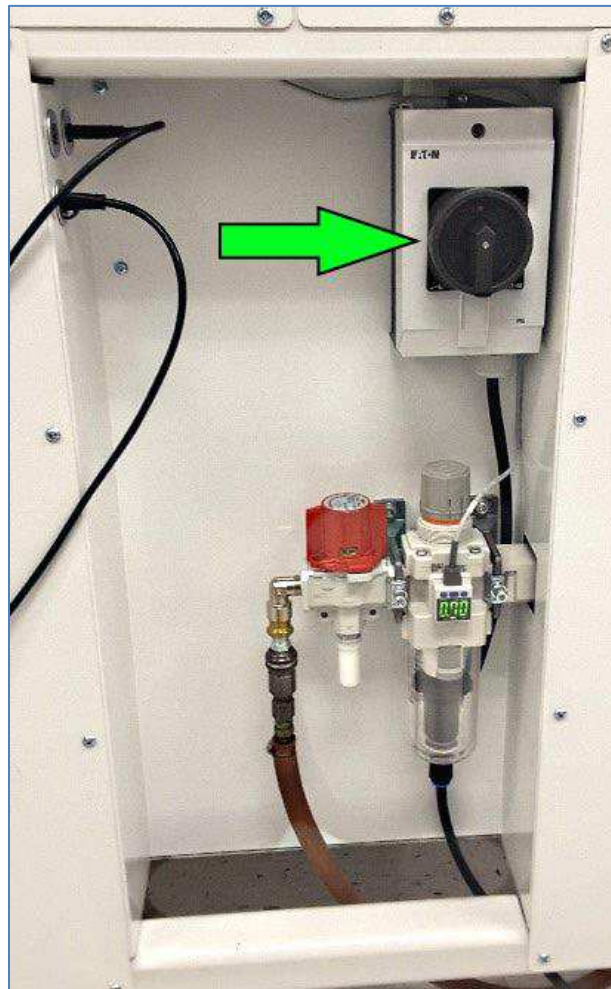

DANGER

Never enter the electrical enclosure immediately after turning OFF the machine power switch and disconnecting the electrical power source. High voltage electrical energy can be present in the electrical enclosure. Read the warning label on the electrical enclosure door before entering the system.

To provide a safe condition for maintenance or repair, rotate the main power switch to the OFF position (as shown in Figure 4) and lock it there by inserting a padlock (not included) into the locking locations.

Figure 4: Locking out electrical power

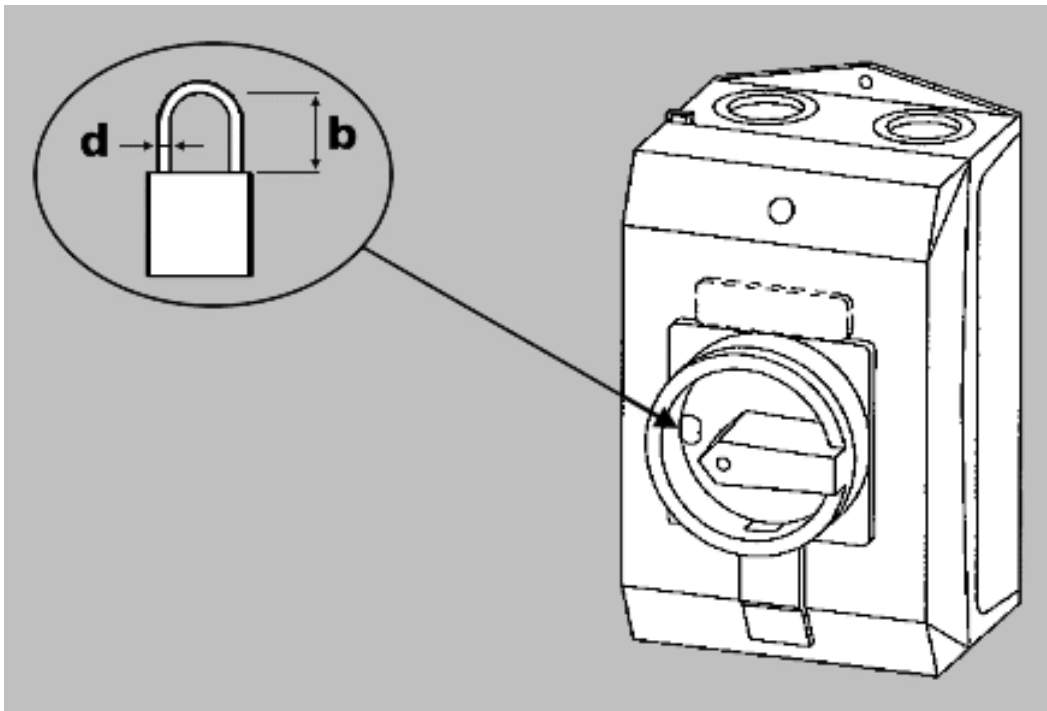

d = 4-8 mm [0.16-0.31 in]

b ≤ 47 mm [1.85 in]



CAUTION

Always turn off the main power switch and disconnect the electrical cord from the power source when performing repair or maintenance on the equipment.



Lock out electrical power when performing maintenance or repair on this equipment.

B. Pneumatic connections

B.1. Pneumatic power disconnect

A manually operated main air disconnect valve is located on the left side of the machine, below the main electrical power switch. The main air valve will exhaust all residual air from the machine when turned from the Supply (SUP) position (Figure 5) to the Exhaust (EXH) position (Figure 6).

Figure 5: Main air disconnect valve in SUP position

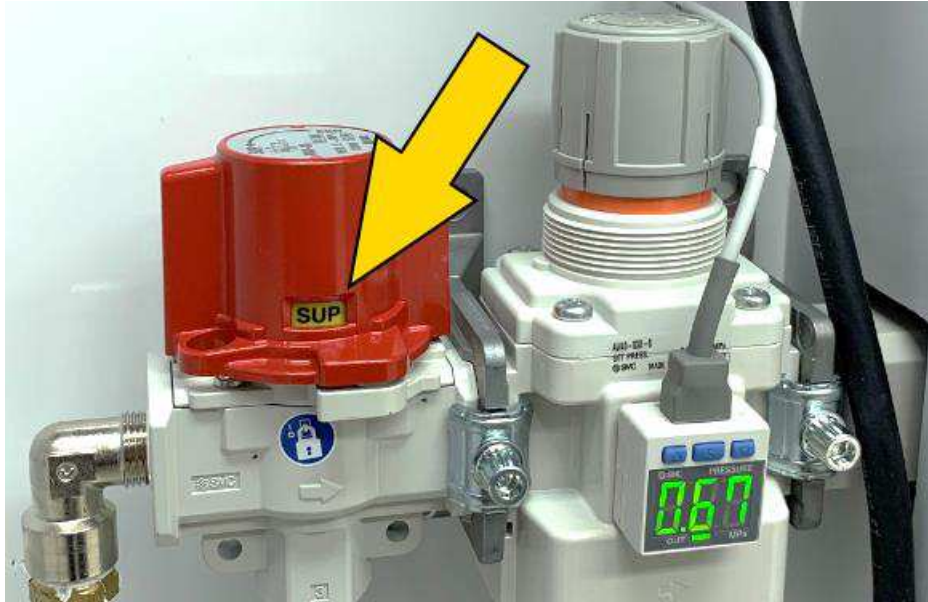

DANGER

Moving parts can crush and cut.



Lock out air supply when performing maintenance or repair on this equipment.



Lock out electrical power when performing maintenance or repair on this equipment.

The valve can be locked in the EXH position (Lock Out/Tag Out) for maintenance or repair by inserting a padlock (not included) into the locking location (Figure 6).

Figure 6: Main air disconnect valve in EXH position

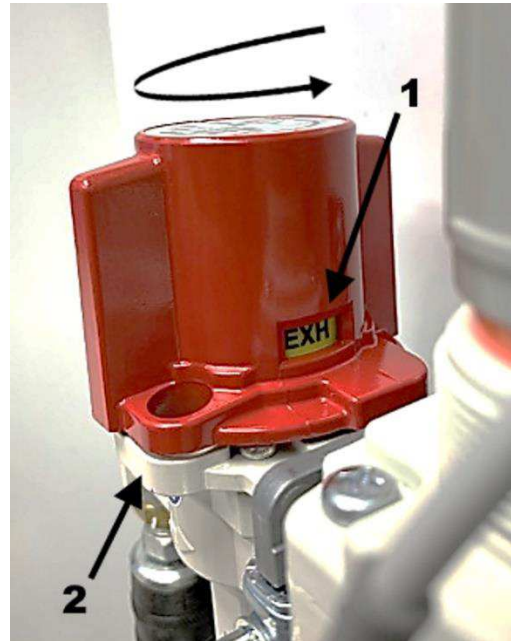

- 1** Indicator shows EXH position
- 2** Install Lock Out/Tag Out padlock here

B.2. Airlock Valve

If the incoming air supply volume is inadequate, the cable grip force can be reduced during the vacuum cycle. The airlock valve maintains the grip pressure to prevent the cable from slipping in the gripper jaws (Figure 7). It also allows the cable grip to be released, if the guard door is opened and the red button on top of the airlock valve is pressed. The airlock valve is located inside the machine's sliding door to the left of the gripper jaws (Figure 7).



CAUTION

The system might be pressurized.

Figure 7: Airlock valve and gripper jaws

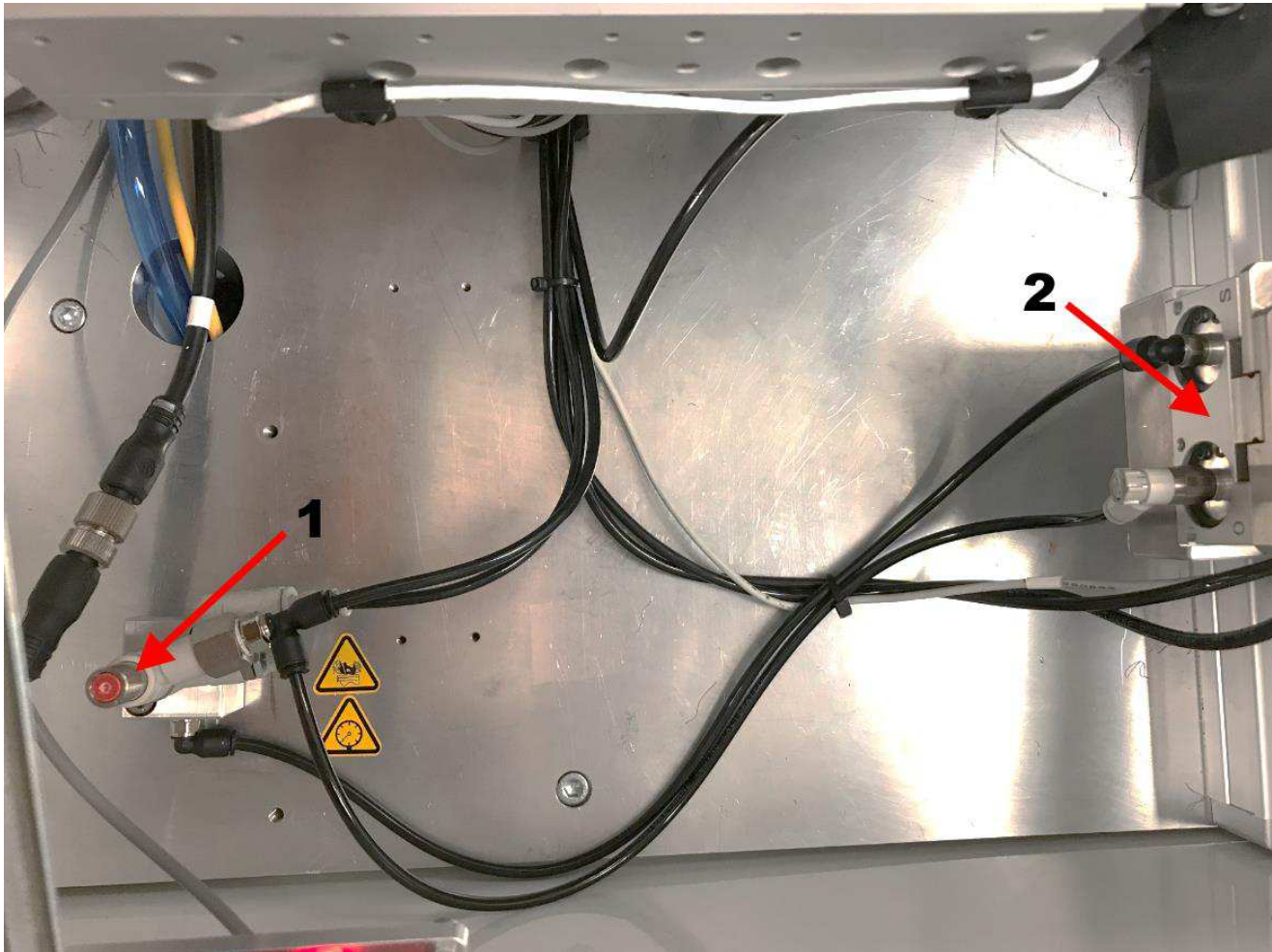

- 1 Airlock valve
- 2 Gripper jaws

2.5. Safety interlocks

The machine has safety interlocks in two locations:

- Under the sliding top guard at the front-left corner of the chassis
- The top-left inside corner of the scrap door

A. Sliding door interlock

The interlock located under the sliding door (Figure 8 and Figure 9) is monitored by a dedicated safety relay. When the sliding door is opened, the four servo-motor axes are disabled through a Safe Torque Off (STO) function. In this state, the drives are still energized, but their motor outputs are disabled, the machine air supply is turned OFF, and residual air pressure is exhausted. This effectively stops all machine motion. When the sliding door is closed, and if the Emergency Stop relay is energized, the Interlock safety relay automatically re-enables the STO outputs and reapplies air pressure.



CAUTION

The machine air supply to the valve controlling the scrap vacuum remains energized when the interlock is interrupted. Disconnect and "Lock Out/Tag Out" the main air supply before performing maintenance or repair.

Figure 8: Top guard interlock closed

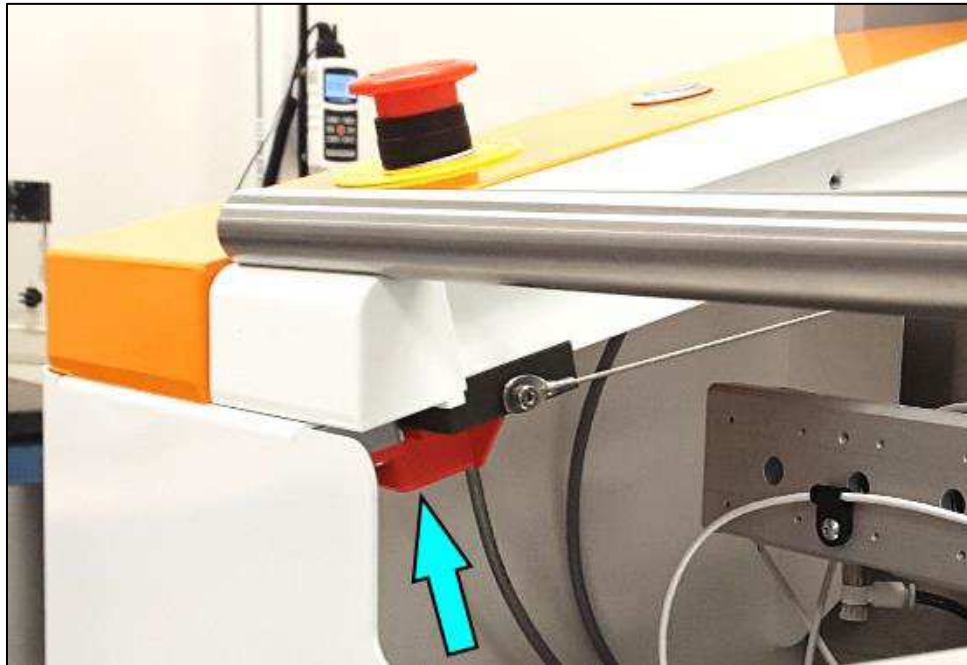
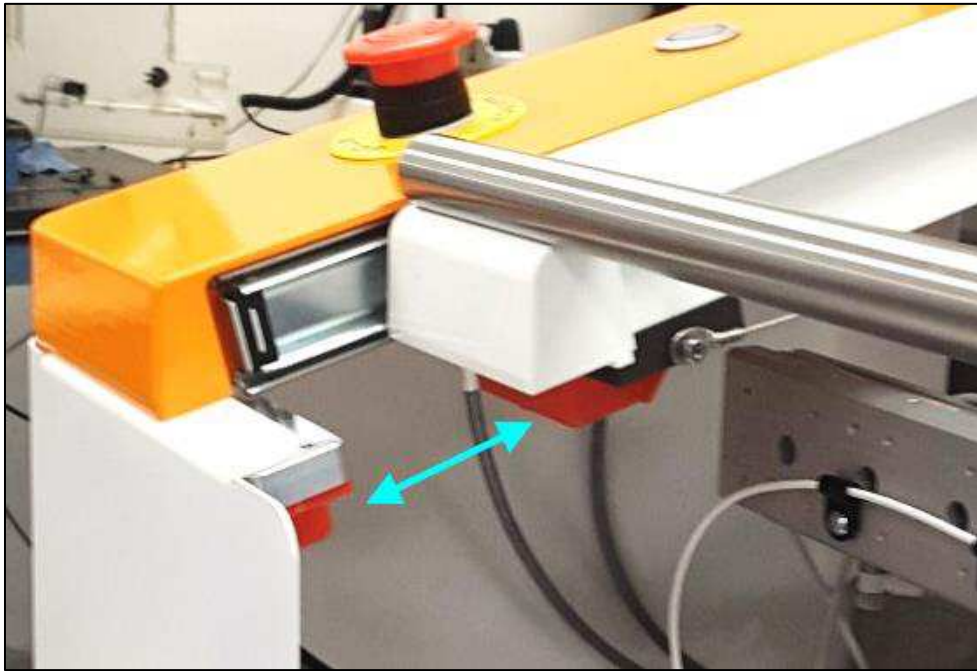

Figure 9: Top guard interlock open



B. Scrap door interlock

Interrupting the scrap door interlock (Figure 10) disables the vacuum system. It does not disable the servos or drop the air pressure.



CAUTION

Do not open or empty the scrap bin while a cable prep cycle is in progress.



NOTE

Resetting an interlock does not automatically restart the machine.

Figure 10: Scrap door safety interlock (open)



2.6. Emergency stop switch

The Emergency Stop (E-STOP) switch is mounted on the top panel of the machine, in the lower left corner (Figure 11). It is clearly visible, but each operator must note the location and understand the operation of the E-STOP control in case of an emergency. Pressing the switch does the following:

- All four servo motor axes are disabled through a Safe Torque Off (STO) function.
- The drives remain powered up, but their motor outputs are disabled.
- The air pressure is evacuated.

This effectively stops all machine motion. The E-STOP switch is monitored by an independently dedicated safety relay.

When pressed, the E-STOP switch latches in the pressed state. In order to continue using the machine, you must reset the Emergency Stop safety relay.

1. Close the sliding door and the scrap door.
2. Turn the Emergency Stop safety relay clockwise to release it.
3. Press and release the white reset button (Figure 11).

Figure 11: Emergency stop controls



- 1 Reset button
- 2 Emergency stop switch

3. DESCRIPTION

3.1. Machine overview

A. Rotating stripping head

The HV-CP is fitted with three blades, three cutting wheels, and a mandrel. This offers many advantages, such as precision centering, braid flaring, and matched toolsets for repeatable processing. The rotating blades cut the entire circumference of the insulation with precision.

B. Multi-step stripping

The HV-CP processes multi-layered conductors in steps that can be programmed in any order. The cut parameters can be independently set and optimized for every level. The stripping machine's memory accommodates different conductors and processing parameters.

C. Operation

The operation of the HV-CP is intuitive. The graphical touchscreen display assists the operator with setting the processing parameters by creating an article: building a cable profile, setting the run parameters, and initiating a production run.

Integrated air jets for automatic blade cleaning and an in-line vacuum to remove slugs keep the processing area clean and efficient. A removable container is located inside the chassis for easy waste disposal.

D. Specifications

Table 1: Specifications

Property	Value
Wire cross section (stripping)	8 mm ² - 120 mm ²
Maximum outer diameter	23.0 mm [0.90 in]
Minimum diameter of inner conductors	6.0 mm [0.24 in]
Maximum outer jacket strip length*	80.0 mm [3.15 in]
Maximum braid strip length*	70.0mm [2.75 in]
Increments for incision diameter	0.01 mm [0.0004 in]
Increment for stripping length	0.01 mm [0.0004 in]
Article library: maximum number of articles	1500
Sequence function: max number of steps	100
Typical cycle time	30 sec

*For information about the increased strip length capabilities of the 2335400-2 HV-CP, contact your TE representative or call the phone number listed in section 8, REPLACEMENT AND REPAIR.

E. Labeling

A label on the left side of the machine (Figure 12) provides the machine part number, serial number, manufacture date, and electrical specifications (Figure 13).

Figure 12: Location of label

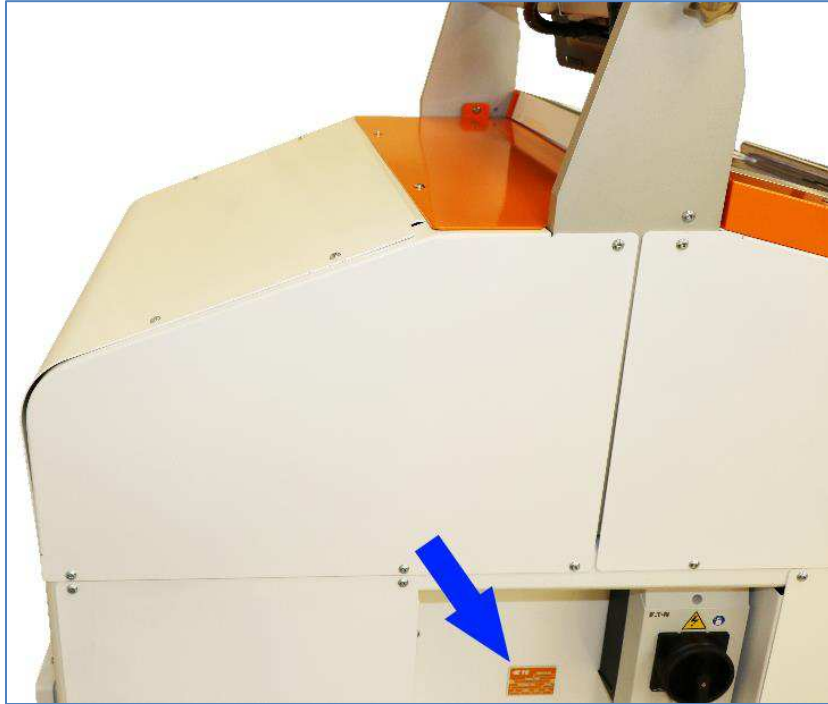
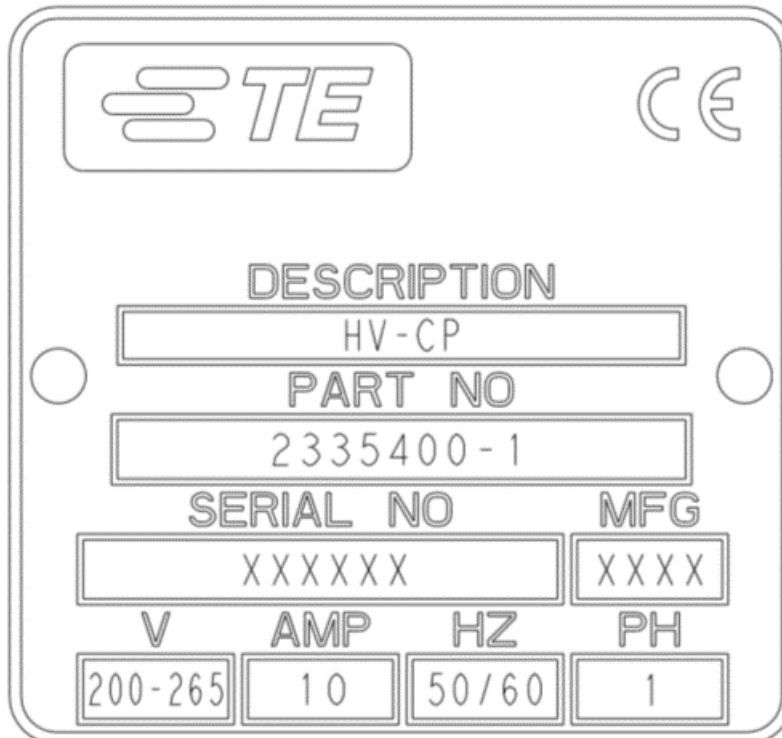

Figure 13: Label



3.2. Specifications

Table 2: Requirements

Electrical	Voltage	200-265VAC
	Frequency	50/60Hz
	Circuit	Single phase
	Current	10 Ampere
Air	Min machine working pressure	0.62 MPa [90 psi]
	Min air volume	570 liters/min [20 cfm]
	Max (preferred) machine working pressure	0.69 MPa [100 psi]
	Max supply line pressure	0.83 MPa [120 psi]
Ambient temperature for operation		5 - 40 deg C (non-condensing)

Table 3: Physical characteristics

Width	690 mm
Height	1500 mm
Depth	1000 mm
Weight	238 kg [524 lbs.]

i **NOTE**
 A customer-supplied 3-conductor power cord, 14 AWG (approx. 2 mm²) is required for the L1, L2, and PE connections. See section 4.2 for directions for connecting the power cord to the machine.

i **NOTE**
 If the minimum air volume requirement of 570 liters/min [20 cfm] cannot be met, then a 225-340 liter accumulator tank can be installed between the air supply line and HV-CP to meet the requirement. Air lines installed between the accumulator tank and HV-CP must have a minimum internal diameter of 9mm.

3.3. Major components

A. Monitor

The touch screen monitor is the key interface with the machine. The viewing angle can be adjusted (see Figure 14) by loosening the knobs on either side of the cross-bar, rotating the bar and then tightening the knobs.

B. Sliding Door

The sliding door (Figure 14) is the main guard for the mechanisms of the machine. The door has a catch at the top of its range, allowing for the door to be held open for the transfer of short cables and tooling changeovers.



NOTE

During the machine cycle, this door must remain fully closed. If the door is opened during a cycle, the cycle stops. This can result in a defective part.

Figure 14: Monitor and sliding door

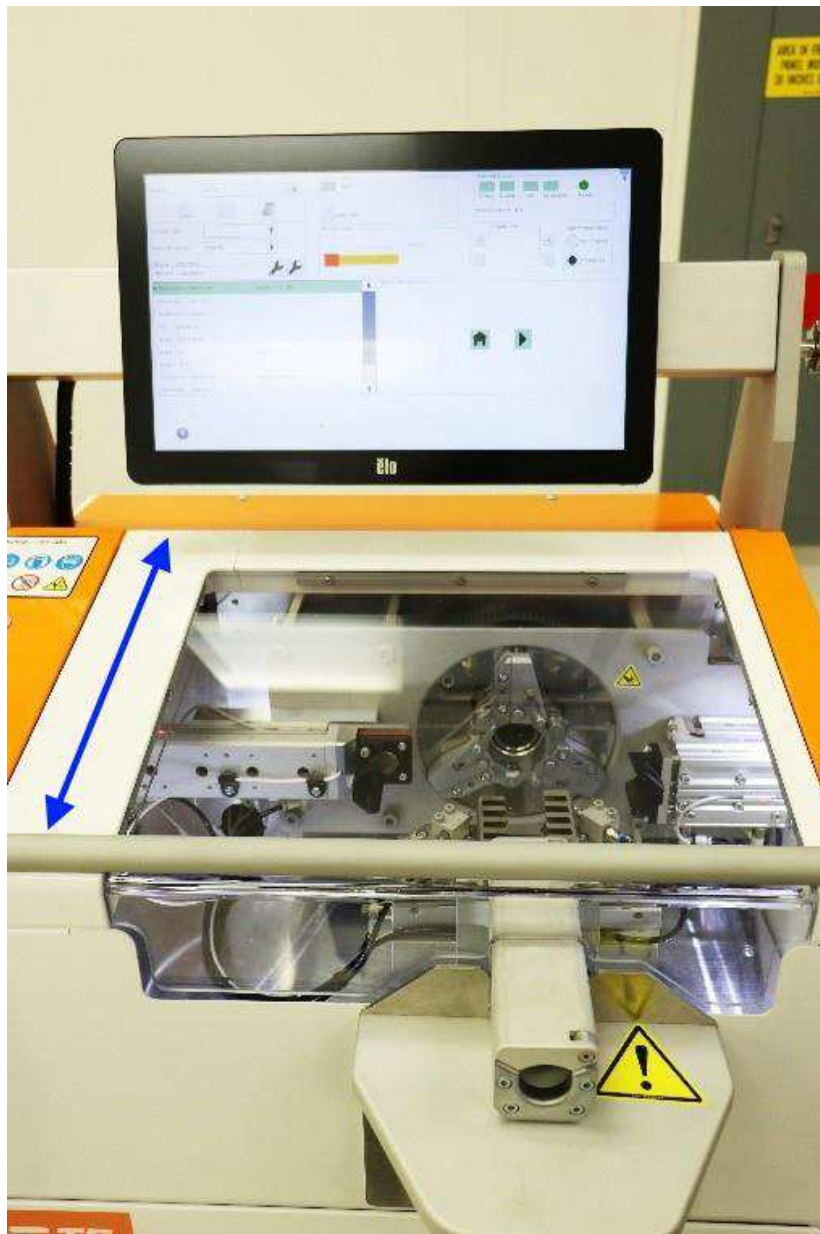

C. Gripper

The gripper clamps and accurately positions the cable during the cycle. After the sequence is initiated, the actuator brings the gripper jaws closer together (Figure 15) until the cable is securely held. In response to the process parameters, the gripper moves the end of the cable to the correct location with respect to the blades and rollers (Figure 16).

**CAUTION**

The gripper moves inward and outward from the machine during the cycle, which causes longer cables to move. This also moves the cable tunnel that extends outside of the machine.

Figure 15: Gripper jaws

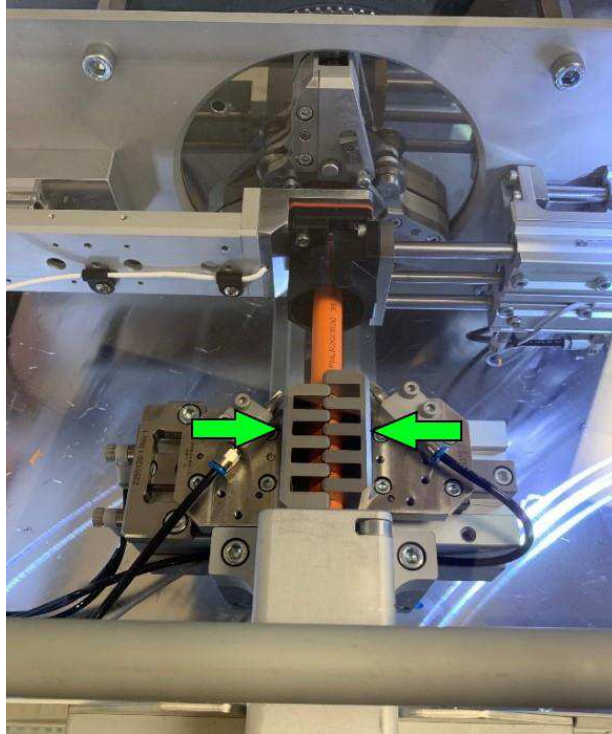
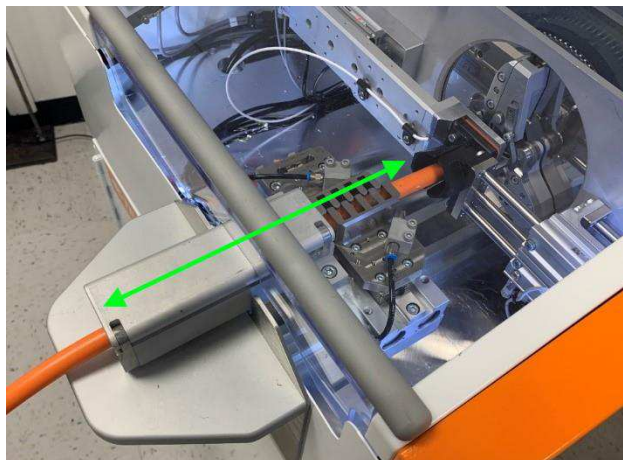

Figure 16: Gripper movement



D. Clamp kit (optional)

The clamp kit assembly 2335410-1 (Figure 17) is an optional tooling package for the HV-CP. It is used when greater cable retention is needed to keep cables from moving during preparation. This is accomplished by using two supplementary pneumatic cylinders to apply additional force to the cable grip jaws. The kit assembly can be installed onto any HV-CP, regardless of the tooling combination or cable size.

Figure 17: HV-CP Clamp Kit Assembly 2335410-1

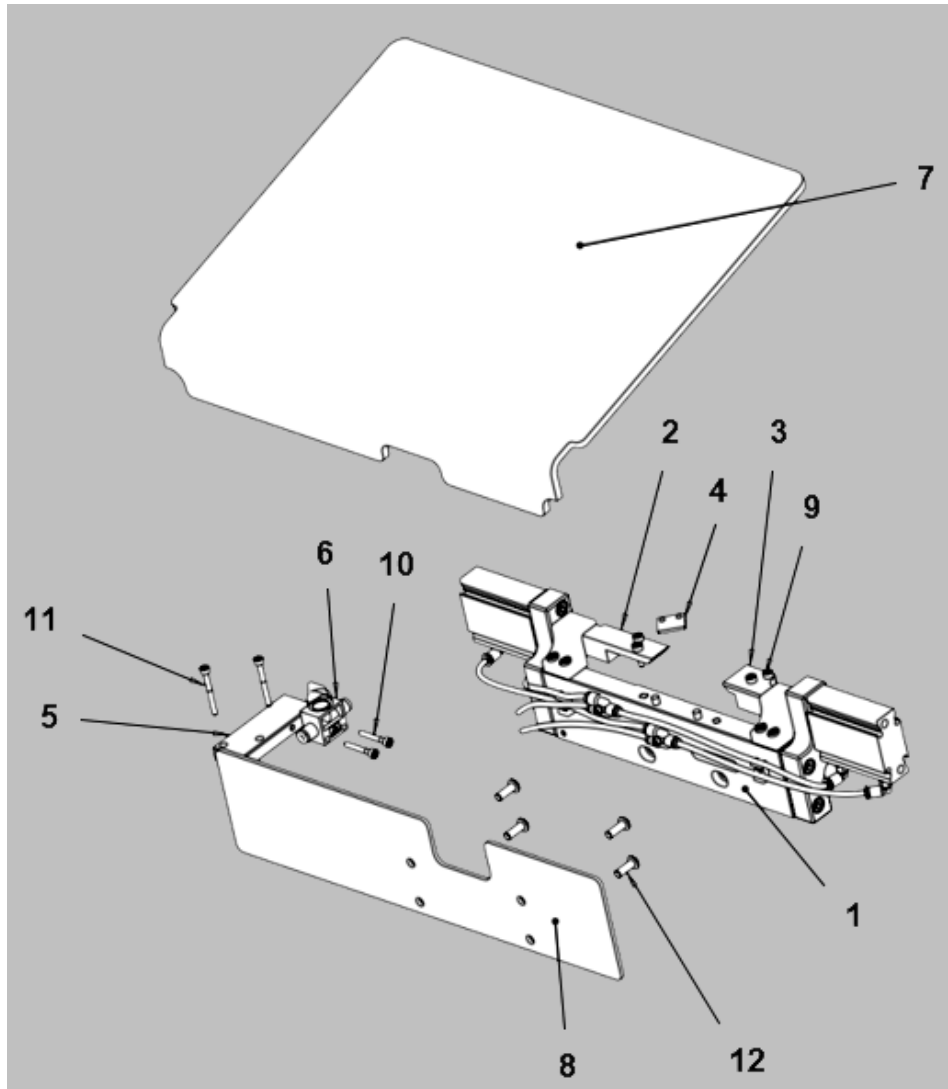

- | | | |
|-------------------------------|----------------------------------|------------------------------|
| 1 Pneumatics clamp kit | 5 Valve mounting base | 9 M4 X 14 screws (4) |
| 2 Left push bracket | 6 Finger valve | 10 M4 X 25 screws (2) |
| 3 Right push bracket | 7 Guard window | 11 M4 X 35 screws (2) |
| 4 Nozzle spacer plate | 8 Scratch-resistant plate | 12 M6 X 16 screws (4) |



NOTE

Consider your application carefully to determine whether the clamp kit is needed. For help deciding whether you need a clamp kit assembly, contact your TE representative or call the phone number listed in section 8, REPLACEMENT AND REPAIR.

The clamp kit has only one mode of operation. To turn the kit ON, rotate the finger valve (Figure 18) a quarter turn clockwise.

- When the clamp kit is turned ON, the machine automatically sends air to the supplementary pneumatic cylinders at the same time as the cable grip jaws.
- When the clamp kit is turned OFF, air is only sent to the primary cable grip jaws.

Figure 18: Finger valve

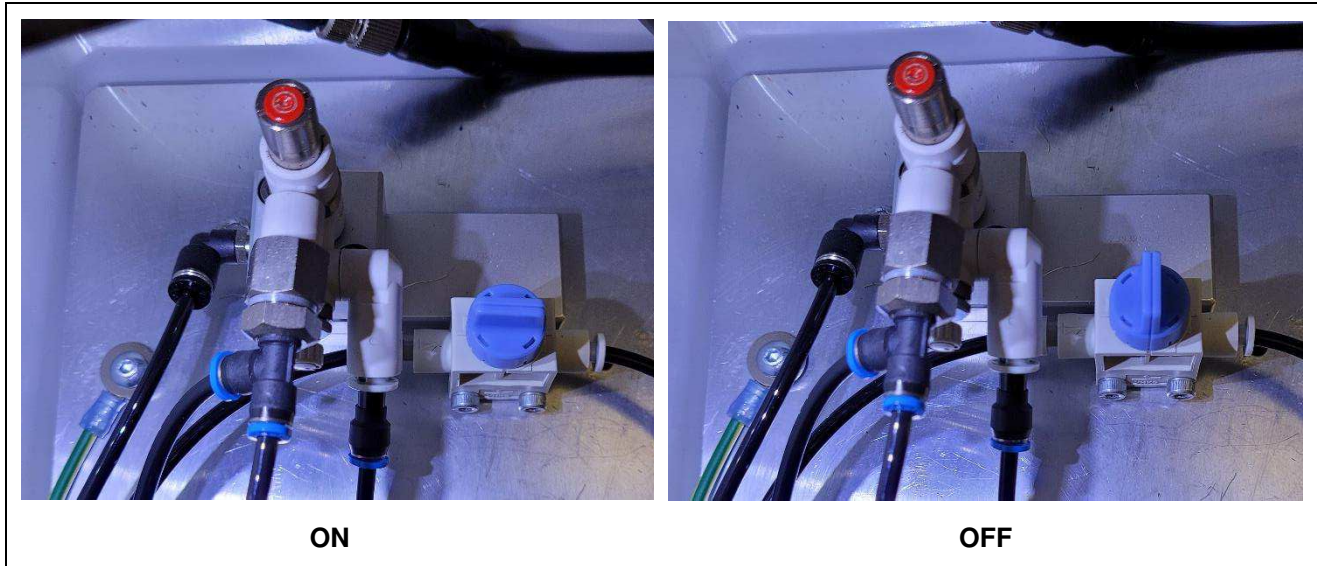

E. Airlock valve

The airlock valve (Figure 7) is designed to improve the performance of the machine by maintaining the grip pressure at all times. If the incoming air supply volume is inadequate, the cable grip force can be reduced during the vacuum cycle. It also allows the cable grip to be released, if the guard door is opened and the red button on top of the airlock valve is pressed.

F. Cutting mechanism

The cutting mechanism is based on relative movement on plates controlled by pulleys and independent motors. The mechanism has two sets of cutting tools: the contour blades and the cutting wheels (see Figure 19).

Quick-change cutting arms: Three arms on the rotating mechanism of the machine hold the contour blades and cutting wheels. These arms rotate to place the blades and wheels for the cutting depth designated in the program.

Contour blades: Three contour blades are used for cutting the insulation and foil layers of the cable. Each blade set is designed for a specific cable size (see Table 4 for tooling specifications). The blades are connected to the cutting arms by a pin and machine screw for easy changeover.

Cutting wheels: Three cutting wheels are used for opening and cutting the braid. The same wheel set can be used for any cable size.

Blade guides (optional): Blade guides are used to limit the cutting depth of the contour blades on certain types of cable that are difficult to process due to insulation hardness or other factors. Blade guides are installed beneath each contour blade. They are generally not required and should only be installed after consulting with TE Connectivity engineering. When using blade guides, the **Blade Guides Installed** selection on the article screen must be set to **YES** to maintain accurate strip lengths. See step 4 on page 65.

Figure 19: Cutting mechanism

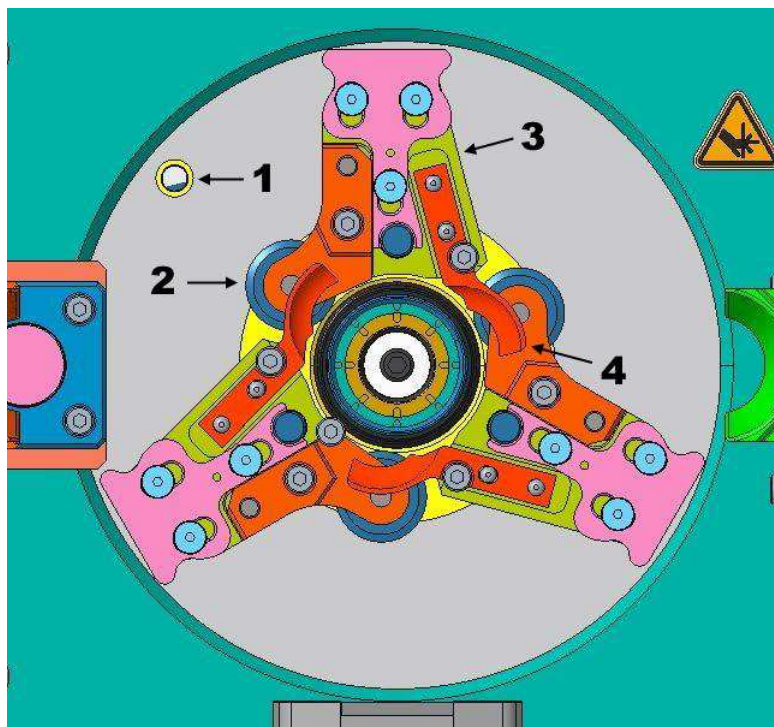

- 1 Calibration hole
- 2 Cutting wheel
- 3 Quick change cutting arm
- 4 Contour blade

G. Mandrel

Providing support for the braid to be cut without affecting the inner insulation is the key function of the mandrel (Figure 20). This component, like the contour blades, is sized specifically for each cable size and should be paired accordingly (see Table 4 for tooling specifications). During a standard cycle, the mandrel is inserted under the braid and over the inner insulation. The cutting wheels move into place against the braid and make a complete cut as the head rotates around the mandrel. The mandrel is a wear item. The machine warns the user when the mandrel is nearing the end of its life expectancy. This is determined by the braid cut depth when it reaches its maximum allowable value. The machine does not allow a user to use a mandrel past this allowable value, preventing the mandrel from breaking during operation.

Figure 20: Mandrel

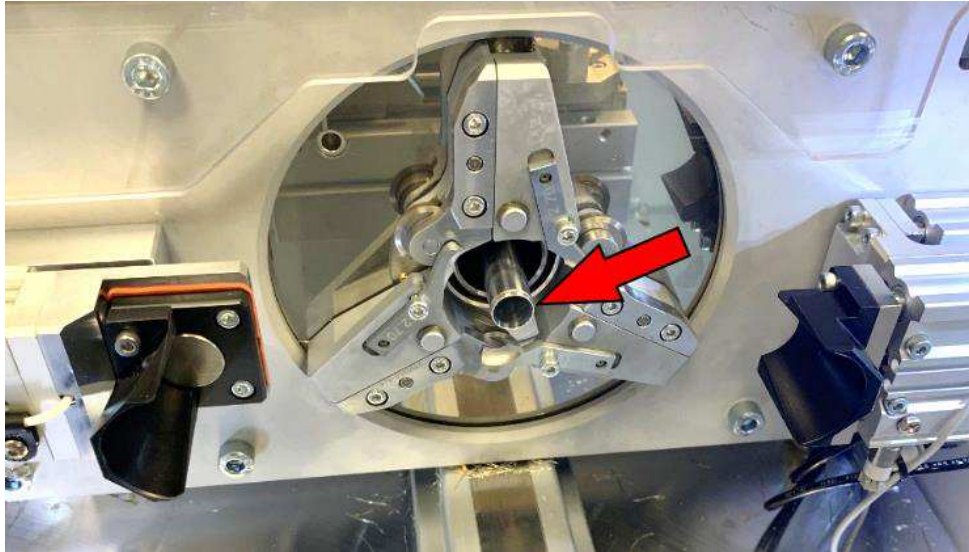

H. Cable sensor

When touched by the cable to be processed (Figure 21), the cable sensor initiates machine function. This feature ensures consistent strip lengths of the cable. It can also be set to automatically run a sequence or run by operator initiation (button on the user interface).

Figure 21: Cable sensor

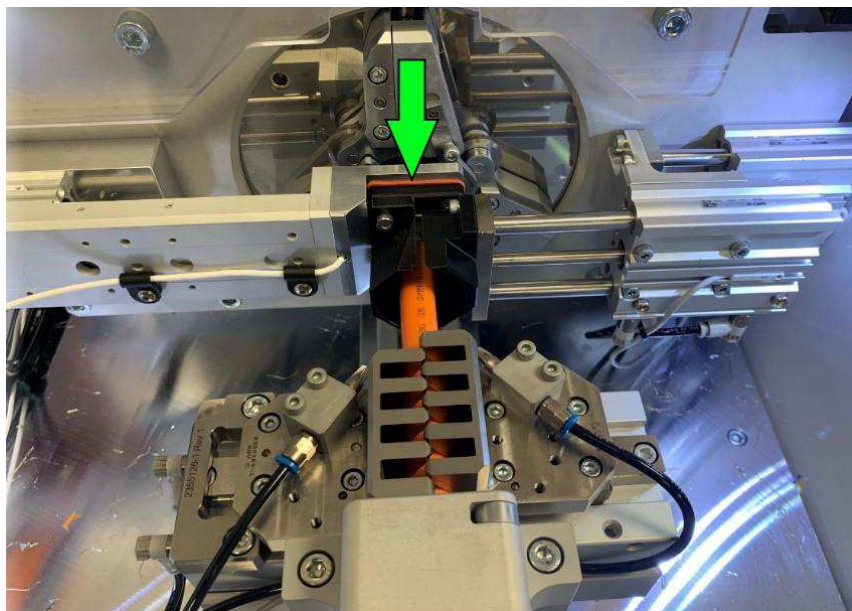

I. Cable Tunnel

This feature of the machine ensures that the cable is centered in the grippers during the cycle and directs the end of the cable to the cable sensor. It consists of top and bottom portions to direct the cable end fully (Figure 22). The cable tunnel's top portion hinges open (Figure 23) to allow shorter leads to be placed. When using the cable tunnel in this manner, operate the machine with Auto Start turned off.

Figure 22: Cable tunnel (closed)



Figure 23: Cable tunnel (open)



J. Scrap bin

The machine has an integral vacuum that draws the process scrap (insulation, foil, braid) into a removable scrap bin (Figure 24). During routine processing, the scrap bin must be removed and emptied to prevent blockage of the vacuum duct. A warning message and the **Trash Full** indicator on the machine status screen indicate when the scrap bin is full. How often the scrap bin must be emptied depends on wire size, strip length, and number of cables processed.

Figure 24: Scrap bin



K. Scrap bin sensor

The machine is equipped with an ultrasonic sensor (Figure 25) that alerts the operator when the scrap bin is nearing maximum capacity. This alert changes the **Trash Full** status indicator to red, and displays a warning that the **SCRAP BIN IS NEARLY FULL**. In order to complete a batch or reach a convenient time to halt production, the operator can select **OK** to return to the production screen and continue production for up to 50 cycles. During this time, the status indicator remains red. If the scrap bin has not been emptied after 50 cycles, a second warning message notifies the operator that the **SCRAP BIN IS FULL**. At this point, the machine does not allow the operator to **HOME** or restart the machine until the scrap bin is emptied.



CAUTION

Failure to empty the scrap bin when alerted can cause clogging and result in scraped cables.

Figure 25: Scrap bin sensor

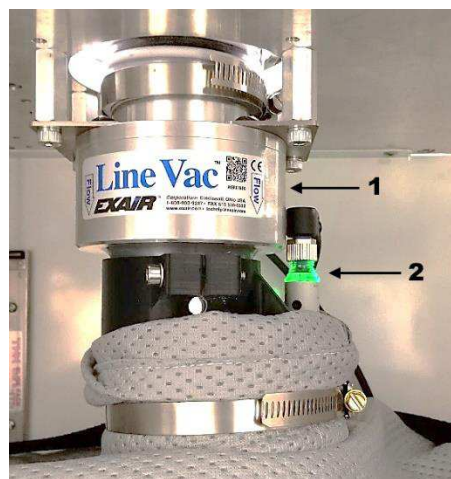

- 1 Vacuum
- 2 Ultrasonic sensor

L. Electrical enclosure and panels

The electrical enclosure and panels (Figure 26) contains all of the electrical components (servo motor drives, logic controllers, safety relays, etc.) for controlling the machine.



DANGER

The electrical enclosure contains no user-serviceable parts. **Do not open the door.** Opening this door **always** presents the danger of electrical shock and must be performed **only** by qualified personnel. Call field service for assistance.

Figure 26: Electrical enclosure

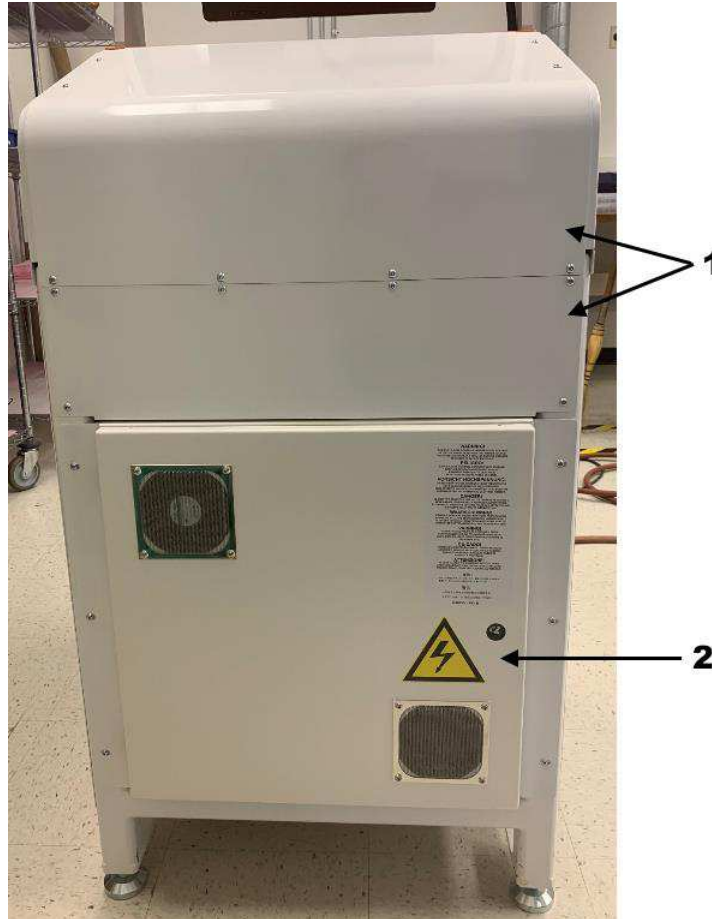

- 1 Panels
- 2 Electrical enclosure

M. Utility alcove

On the left side panel of the machine (Figure 27), a recessed area (utility alcove) contains the pneumatic supply assembly, main disconnect and power cord, two USB 3.0 ports and one RJ-45 connector (Figure 28).

Figure 27: Location of utility alcove



Figure 28: Contents of utility alcove

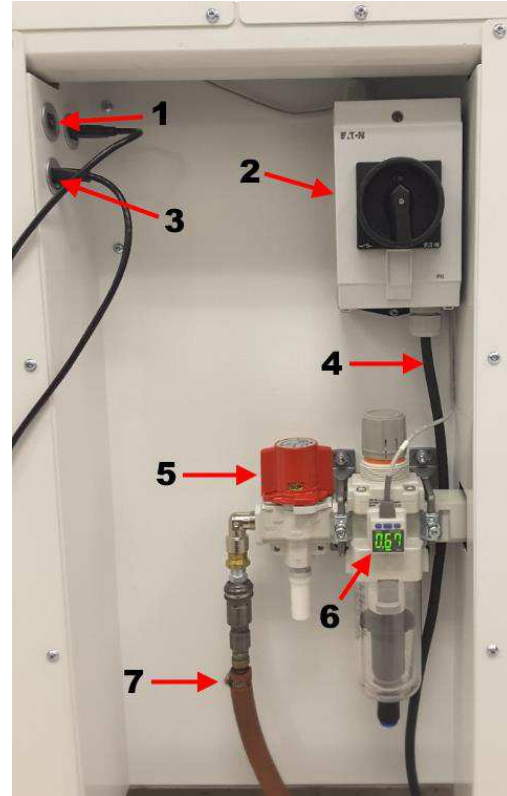

- 1 USB 3.0 ports (2)
- 2 Main power disconnect
- 3 RJ45 connector
- 4 Power cord
- 5 Main pneumatic disconnect
- 6 Digital pressure switch
- 7 Pneumatic supply

Main power disconnect and power cord: Turning the switch to the ON position supplies AC power to the machine. Turning the switch to the OFF position disconnects the incoming AC power. It can be locked in the OFF position for safety and security purposes.

Main pneumatic disconnect: Provides oil-free and water-free air for machine operation. This assembly contains a pneumatic lock out valve and a digital pressure switch.

i NOTE
The digital pressure switch is factory set. Do not modify the setting of the switch.

USB port: Two USB 3.0 receptacles are available for connection to USB flash drives for data backup and software updates.

RJ-45 connector: The RJ-45 connection provides access to the Local Area Network (LAN) for Manufacturing Execution System (MES) connectivity.

This machine transmits data over the ethernet using Message Queuing Telemetry Transport (MQTT), a publish-subscribe based messaging protocol. By implementing an MQTT message reader, a customer can have everything needed to track the process in many ways and permanently store that data for future reference.

i **NOTE**
Contact Application Tooling engineering for details regarding implementation of an MQTT message reader.

N. Tooling

Instructions for a tooling changeover (different cable) or tooling replacement (worn or broken tooling) are presented in section 6.3. Cutting wheels, contour blades, and mandrels are wear items. Order several sets of tooling and keep them on hand at all times.

Use Figure 29 to understand how to choose the appropriate tooling from Table 4. The core diameter listed for the tooling must be greater than the core diameter of the cable to be prepared.

Figure 29: Cable diameters

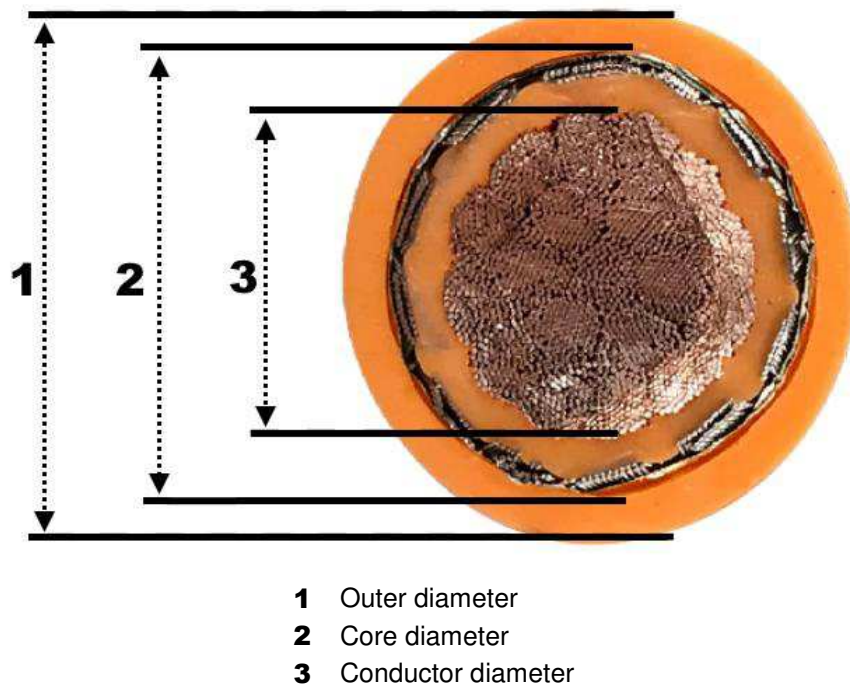

Table 4: Tooling specifications

Cable size mm ²	Core diameter mm	Manual override mm	Mandrel	Contour blade kit	Cutting wheel kit
8	5.3	-	1-2360456-0	2364113-1	2364114-1
10	6.0	-	2360456-1	2364113-1	
16	7.2	-	2360456-2	2364113-2	
25	8.8	-	2360456-3	2364113-3	
35	10.5	-	2360456-4	2364113-4	
50	12.1	12.09 - 12.20	2360456-5	2364113-5	
60	13.0	12.99 - 13.30	2360456-6	2364113-6	
70	14.4	-	2360456-7	2364113-7	
95	17.2	-	2360456-8	2364113-8	
120	19.0	-	2360456-9	2364113-9	



NOTE

For the part numbers of blade guides and long strip mandrels, contact your TE representative or call the phone number listed in section 8, REPLACEMENT AND REPAIR.



NOTE

Table 4 lists the correct tooling needed for each cable size. The manual override column only applies to two of these sizes. Due to variances in cable brands, some cable sizes have overlapping core diameters. In these cases, the operator must select the appropriate tooling. The manual override column shows the possible overlapping ranges.

4. RECEIVING INSPECTION AND INSTALLATION

4.1. Receiving inspection

The machine is thoroughly inspected during and after assembly. Before it is packed for shipment, a final series of tests and inspections are made to ensure proper functioning.

1. After the machine is received at the facility of use, compare it to Figure 30. Make note of any differences.
 - If tooling, blades, mandrels, etc. are shipped separately, they must be inspected separately.
 - Examine the Tip(N)Tells™ and photograph them if they indicate tipping or mishandling during shipment.

Figure 30: How a newly-received HV-CP should look



2. Uncrate the machine where the light is sufficient for careful examination.
3. Remove the heat seal bag.
4. Remove the four lag bolts securing the mounting plates to the pallet.
5. Examine the machine for any signs of damage during shipping. Document your findings.
6. Carefully move the machine to the location where it will be used.

**NOTE**

Lift from the bottom of the machine. Keep forks spread as wide as possible for better stability.

7. Remove the bubble wrap protecting the monitor (Figure 31).

Figure 31: Removing the bubble wrap



8. Remove the two zip ties holding the monitor adjustment knobs (Figure 32).

Figure 32: Removing the zip ties

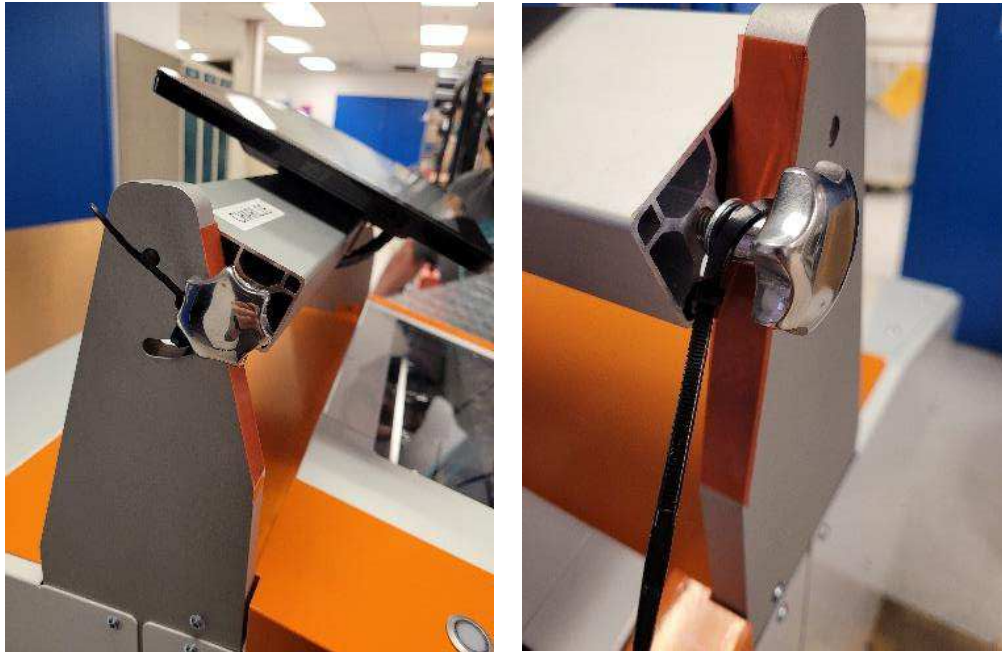

9. Reinstall the monitor adjustment knobs through the slots of the monitor support bars (Figure 31).

Figure 33: Reinstalling monitor adjustment knobs



10. Remove the corrugated cardboard inserts securing the scrap bin (Figure 34).



DANGER

To prevent static shock, the cardboard inserts must be removed before operation. The scrap bin must sit directly on the floor of the enclosure to prevent static build-up.

Figure 34: Removing the corrugated cardboard inserts



11. Remove the tie-wraps from the door weights on the left side (Figure 35) and the right side (Figure 36).

Figure 35: Left door weight

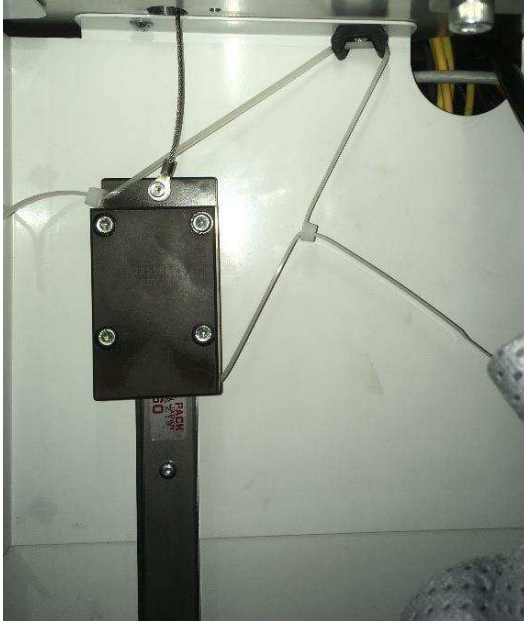
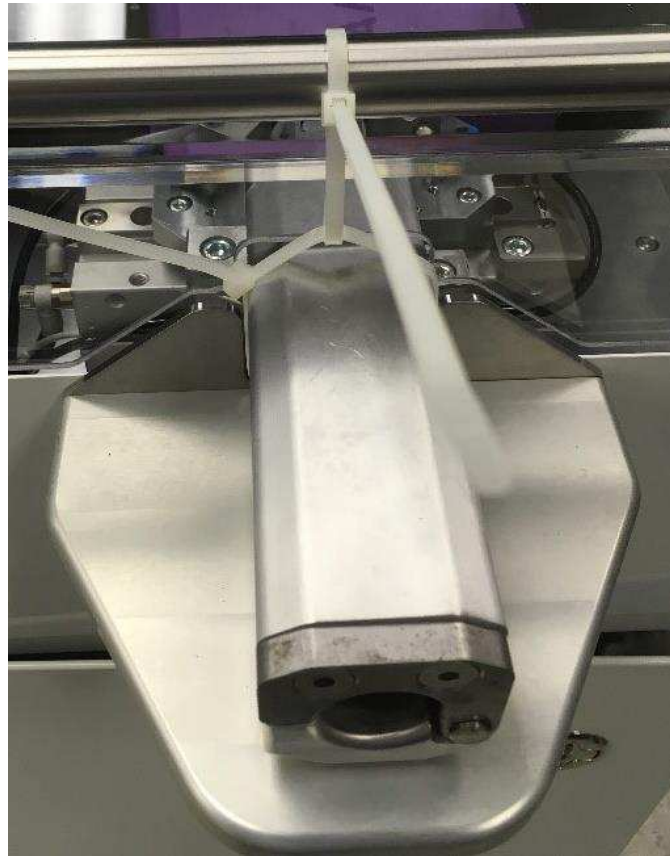

Figure 36: Right door weight



12. Remove the tie-wraps holding the top guard in place (Figure 37).

Figure 37: Top guard tie-wraps



13. Remove the tie-wrap holding the wire pull actuator in place (Figure 38 and Figure 39).

Figure 38: Cable tunnel (top view)

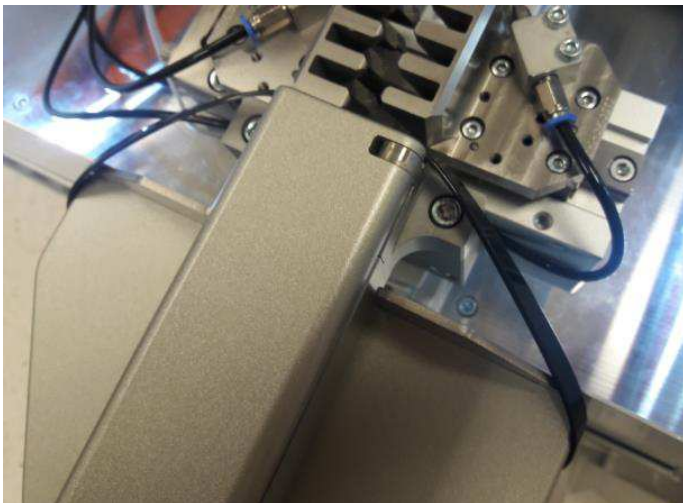

Figure 39: Cable tunnel (side view)



14. Remove the tie-wrap holding the electrical enclosure key in place (Figure 40). Store the key in a safe location.
15. Remove the tie-wrap holding the main air disconnect valve in the EXH position (Figure 40).

Figure 40: Electrical enclosure key and main air disconnect valve



- 1** Main air disconnect valve
- 2** Electrical enclosure key

16. Remove the tie-wrap holding the gripper jaws together (Figure 41).

Figure 41: Gripper jaws

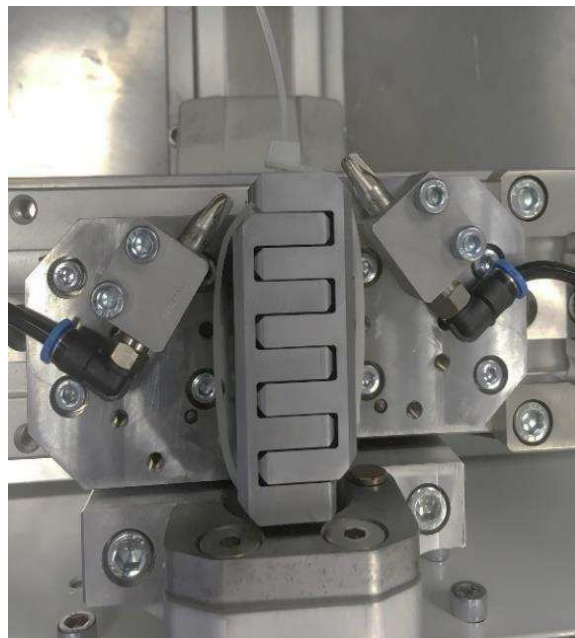

17. Remove tie-wraps holding the left and right cable gate cylinders in fixed positions (Figure 42 and Figure 43).

Figure 42: Left cable gate cylinder



Figure 43: Right cable gate cylinder



18. Verify that all components are secure.
19. Check all wiring for loose connections, frayed or broken wires and damaged insulation.
20. Verify that all components and parts listed in the Bill of Lading are accounted for.

4.2. Installation

1. With the machine in the production location, use a bubble level to level the machine by adjusting the four supplied foot levelers.
2. Connect the pneumatic supply to the port provided in the utility alcove in the left side panel of the machine. Any supply pressure in the .552-.827 MPa [80-120 psi] range is acceptable.
3. Install a quick disconnect onto the customer-supplied industrial air line and connect it to the machine port. The final connection should resemble Figure 44.



NOTE

The digital pressure switch and the air regulator are set at the factory. Do not modify their settings.

Figure 44: Connecting the pneumatic supply

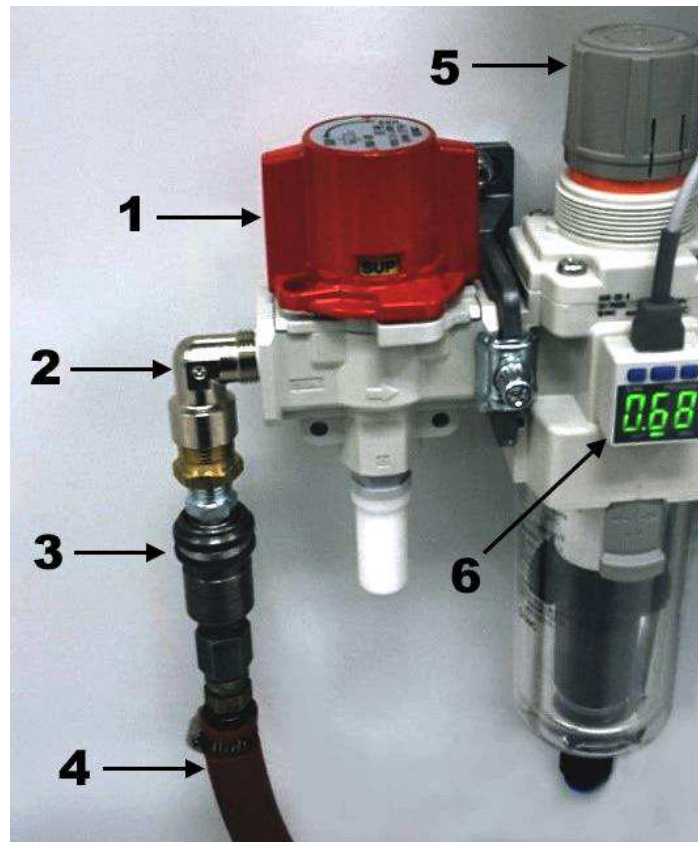

- 1 Pneumatic lockout valve
- 2 Main supply port
- 3 Quick disconnect (customer supplied)
- 4 Air line (customer supplied)
- 5 Machine air regulator
- 6 Digital pressure switch

4. Ensure that the electrical supply meets the requirements shown on the machine ID label (Figure 13):
 - 200 to 265V AC
 - 50/60Hz
 - Single phase (L-N or L-L)
 - 10 Ampere
 - Protected by a breaker rated for at least 10,000 IAC

5. At the main disconnect, install a customer-supplied three-conductor power cord rated for the supply voltage and current capacity.

Before connecting the power cord, you must disassemble the main disconnect (Figure 45)

Figure 45: Main power disconnect switch

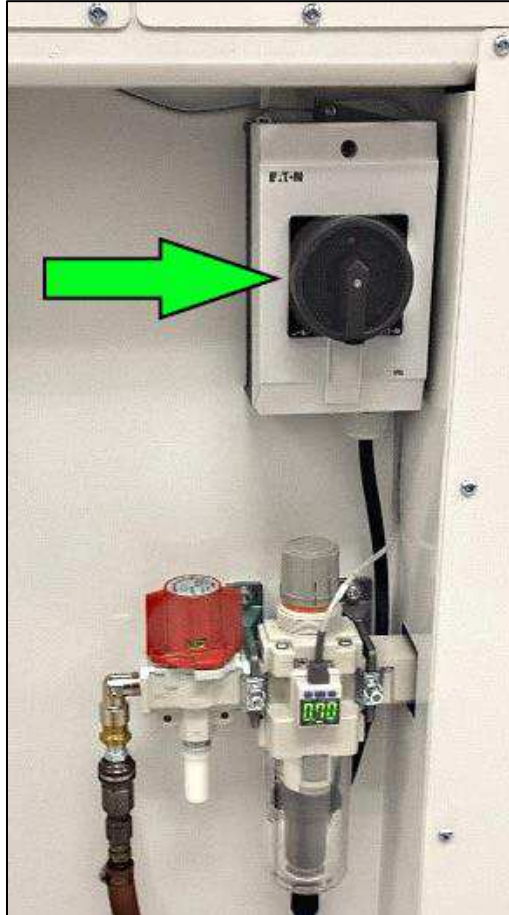

6. Open the disconnect enclosure as shown in Figure 46.
 - a. Remove the dial screw.
 - b. Remove the dial.
 - c. Remove the two faceplate screws.
 - d. Remove the faceplate.
 - e. Remove the two cover screws.
 - f. Remove the cover.

Figure 46: Disassembling the disconnect enclosure

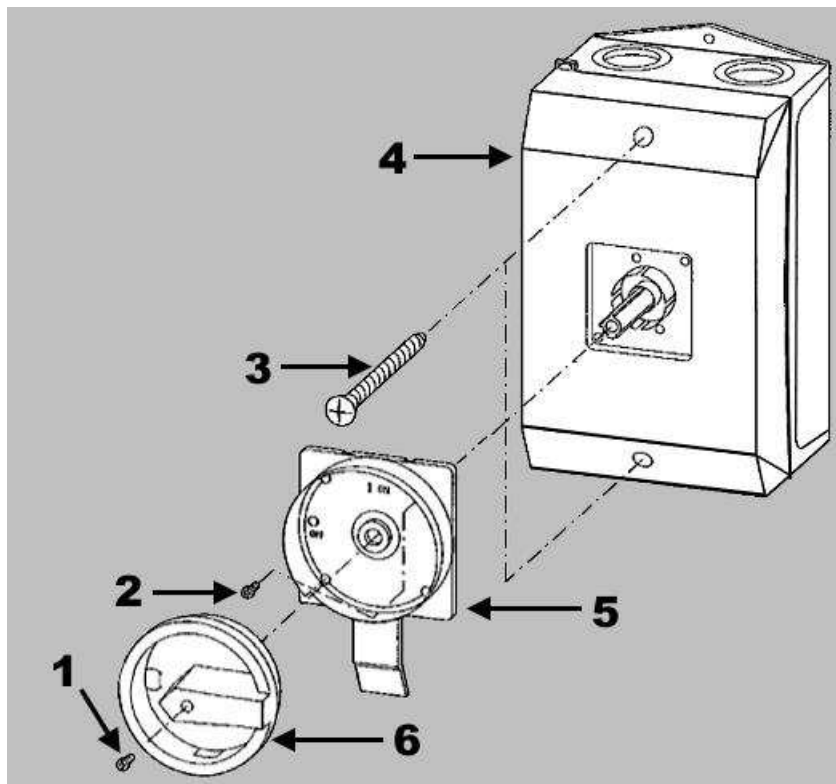

- 1** Dial screw, 0.6 Nm [5.31 lb-in]
- 2** Faceplate screws (x2), ST 3.9 x 19, 1 Nm [8.85 lb-in]
- 3** Cover screws (x2), 1.2 Nm [10.62 lb-in]
- 4** Cover
- 5** Faceplate
- 6** Dial

7. Feed the power cord through the cable gland at the bottom of the disconnect enclosure (Figure 47).
8. Connect line conductors to main disconnect switch terminals (Figure 47).

Figure 47: Interior of disconnect enclosure



- 1** L1
- 2** N or L2
- 3** Ground
- 4** Power cord cable gland

9. After installing the power cord (Figure 48), tighten the cable gland to secure the cord.

Figure 48: Disconnect enclosure with power cord installed



10. Reassemble the disconnect enclosure by reversing step 6.

5. OPERATION

5.1. Overview

Standard operation includes a series of automated functions:

1. Cutting and stripping the outer insulation
2. Flaring the braid
3. Inserting the mandrel
4. Cutting and stripping the braid
5. Cutting and stripping the inner insulation

Before the machine can operate, at least one article must be created. These functions can be created and modified by means of the User Interface (see section 5.2).

1. The cycle starts when a cable is inserted through the cable tunnel and moved forward until the cable end contacts the auto sensor.
 - If Auto Start is enabled, the cycle initiates when the cable contacts the sensor.
 - If Auto Start is not enabled, the operator must press the manual cycle start button to start the cycle.



CAUTION

Verify that the cable size you are using matches the article on the machine. Using the wrong size cable can result in damage to tooling, machine, and cable.

2. The cable grip jaws close around the cable. The cable sensor and cable tunnel move out of the way. The cable is moved automatically into the blade area. The machine executes the Articles process steps.
3. After the cycle is complete, the gripper moves the cable toward the front of the machine and opens the gripper jaws, allowing the cable to be removed from the machine.

5.2. User interface

The HV-CP monitor displays the software for creating and using different articles. The user interface (UI) software has one main screen, identified as the Production Screen (Figure 49). This screen is most-used when operating the HV-CP.

A. Toolbar

To expand the toolbar in the UI, touch the menu expand/collapse arrow (Figure 49). Touch the arrow again to collapse the toolbar.

Figure 49: Production screen

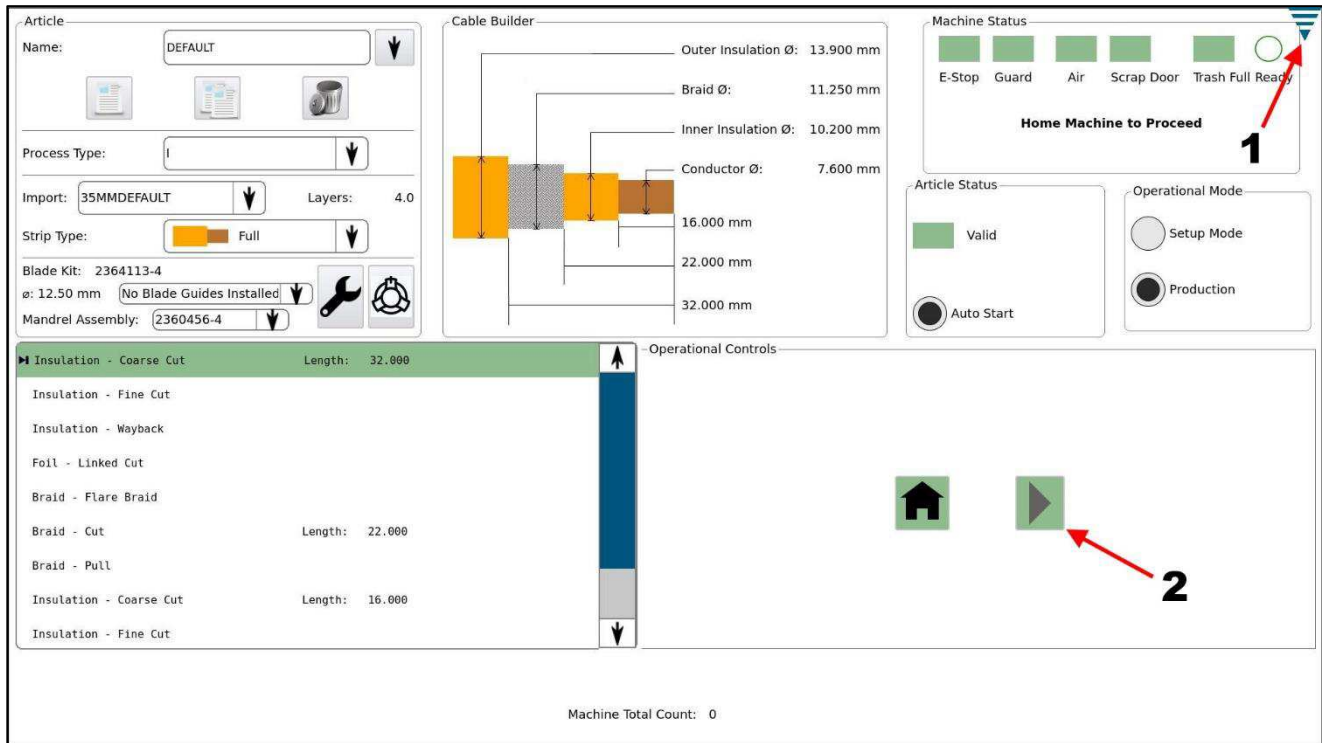

- 1 Menu expand/collapse arrow
- 2 Manual cycle start button

- Touch the **Back-Arrow** button to return to the previous screen.
- Touch the **Home** button to display the Production screen.
- The **Help** button is not used with this model.
- Touch the **Control Panel** button to display the control panel.

Figure 50: Toolbar



- 1 Back arrow
- 2 Home button
- 3 Help button
- 4 Control Panel button

Touching the Control Panel icon on the toolbar (Figure 50) displays the Control Panel. Figure 51 shows the control panel icons that are used by the HV-CP administrator.

Figure 51: Control panel



B. Selecting a language

To pick a language, complete the following steps.

1. On the control panel, touch the language icon. The language dialog is displayed (Figure 52).

Figure 52: Selecting a language

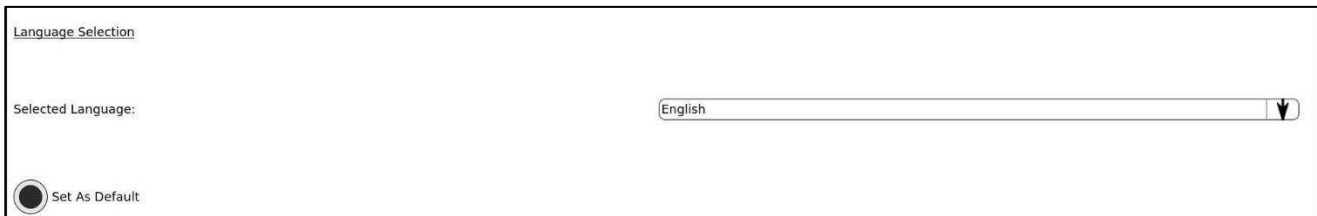

2. Touch the down-arrow button to the right of the language field. A list of available languages is displayed.
3. Touch the language you want to use.
4. If you want the selected language to be automatically selected when the unit powers ON, touch the Set as Default button. Your settings are automatically saved when you leave this screen.

C. Setting the date and time

1. To set the time, touch the **Date/Time** icon. The clock is displayed (Figure 53).

Figure 53: Setting the time

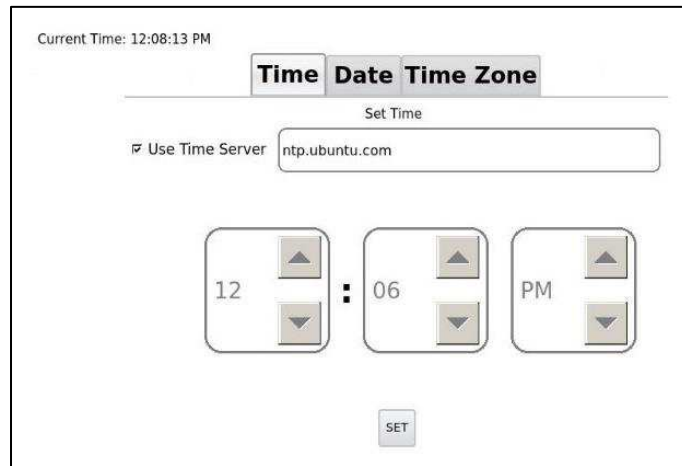

2. Use the up and down arrow buttons (Figure 53) to set the time.
3. Touch the **SET** button to save.
4. To change the date, touch the **Date** tab. The calendar is displayed (Figure 54).

Figure 54: Setting the date

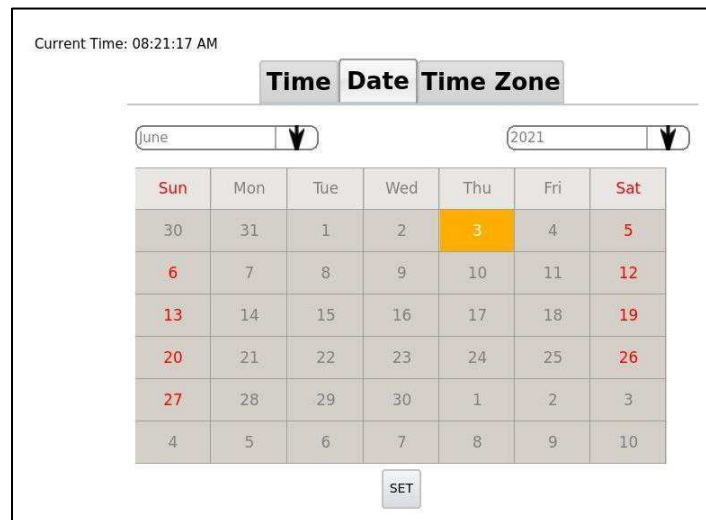

5. Change the month, day, and year to the correct value.
6. Touch the **SET** button to save.

7. To set the time zone, touch the Time Zone tab. The time zone is displayed (Figure 55).

Figure 55: Setting the time zone



8. Touch the drop-down arrow and select a time zone from the menu.
9. Touch the **SET** button to save.

D. Adding users

Administrators can add new users on the Users screen (Figure 56). This screen can be accessed by touching Users on the Control Panel (Figure 51).

Figure 56: Users screen

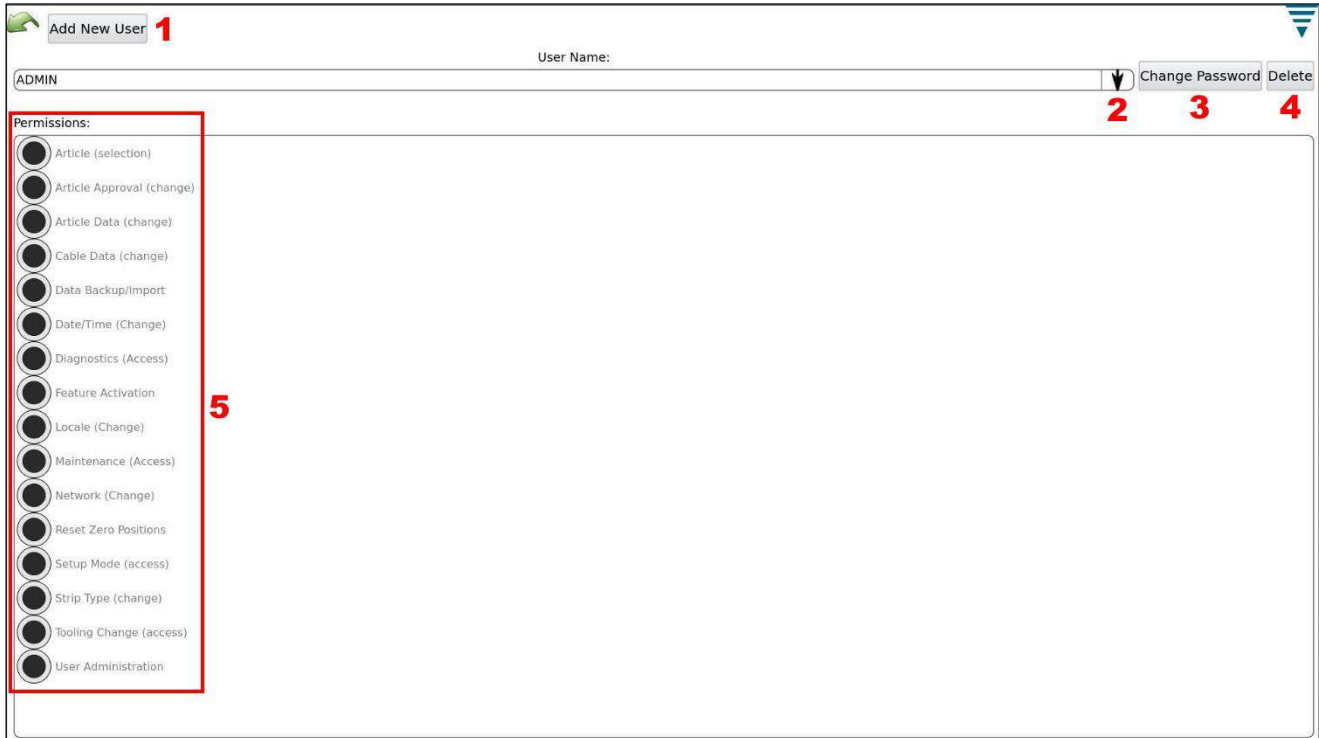

- 1 Add New User button
- 2 Down-arrow button
- 3 Change Password button
- 4 Delete button
- 5 Permissions buttons

1. In the upper left corner, touch the **Add New User** button. A new user form is displayed (Figure 57).

Figure 57: New user form

The screenshot shows the 'New user form' interface. At the top left, there is a green arrow icon. Below it is a text box with the prompt 'Enter the user name and password'. Below this are three input fields: 'User Name:', 'Password:', and 'Verify Password:'. Each input field has a corresponding label to its left.

- 2. Enter the username.
- 3. Enter the password.
- 4. Verify the password by entering it again.

5. Touch the **Add User** button.

E. Changing passwords and deleting users

From the Users screen, you can also change a user's password or delete a user.

1. Touch the down-arrow button to the right of the **User Name** field (Figure 56). A list of users is displayed.
2. Touch the name of the user you want to modify. That user is selected.
3. In the upper right corner, touch the **Change Password** button or the **Delete User** button (Figure 56).
 - **Change password:** Enter a new password and then verify the password by entering it again.
 - **Delete user:** The selected user is deleted.

F. Setting user permissions

Administrators can set permission levels for each operator using the Permissions buttons on the Users screen (Figure 56).

1. Touch the down-arrow button to the right of the **User Name** field (Figure 56). A list of users is displayed.
2. Touch the name of the user you want to modify. That user is selected.
3. Touch the buttons for the permissions that you want to grant to the selected user (Table 5).

Table 5: Permission settings

Setting	Operator can . . .
Article	Change articles.
Article Approval	Not used with model. Turn this permission off for all users.
Article Data	Access “new,” “copy,” “delete,” “process type”
Cable Data	Import and modify cables (for example, cable layer diameters and strip lengths).
Data Backup/Import	Back up or import articles with a USB flash drive.
Date/Time	Change the date, time, and time zone.
Diagnostics	Access the Diagnostics screen.
Feature Activation	Used with model 2335400-2 only.
Locale	Change the Thousands Separator, Decimal Symbol, Time Format, Date Format, and Units.
Maintenance	Access the Maintenance screen.
Network	Access the Network screen.
Reset Zero Positions	Reset the zero positions of the blades, gripper, and mandrel.*
Setup Mode	Process parameters for each of the different sequence steps.
Strip Type	Switch between three strip types: Full, Slice, and None.
Tooling Change	<ul style="list-style-type: none"> • Move the machine to the tooling position using the Tool Change button • Change the mandrel assembly kit • Choose whether to install blade guides
User Administration	Add new users and edit their permissions.

* **Reset Zero Positions** settings are located on the Maintenance screen. To use these features, users must also have **Maintenance** permission.

Table 6 lists recommended permission levels, based on operator and administrator needs.

Table 6: Recommended permissions

User	Permissions	Operator can . . .
Operator A	No permissions	<ul style="list-style-type: none"> Use the HV-CP in production mode Turn Auto Start on and off
Operator B	<ul style="list-style-type: none"> Article Strip type 	Same permissions as Operator A plus: <ul style="list-style-type: none"> Switch between articles of the same cable size Change Strip Type
Operator C	<ul style="list-style-type: none"> Article Strip Type Tooling Change 	Same permissions as Operator B plus: <ul style="list-style-type: none"> Switch between articles of different cable sizes
Operator D	<ul style="list-style-type: none"> Article Article Data Cable Data Data Backup/Import Setup Mode Strip Type Tooling Change 	Same permissions as Operator C plus: <ul style="list-style-type: none"> Create, modify, import, and back up articles
Operator E	All permissions	Access the full functionality of the HV-CP (administrator-level access)

G. Configuring remote support

Remote support gives engineers full access and functionality of the machine over the network. It is used only with machines on the TE network.

1. On the Control Panel, touch the **Network** icon (Figure 58).

Figure 58: Remote Support and Network icons



1. The **Network** page is displayed with the **Configuration** tab selected..
2. Touch the Status tab. An IP address is displayed. Record this address.
3. Navigate back to the Control Panel.

Figure 59: IP address on Status tab

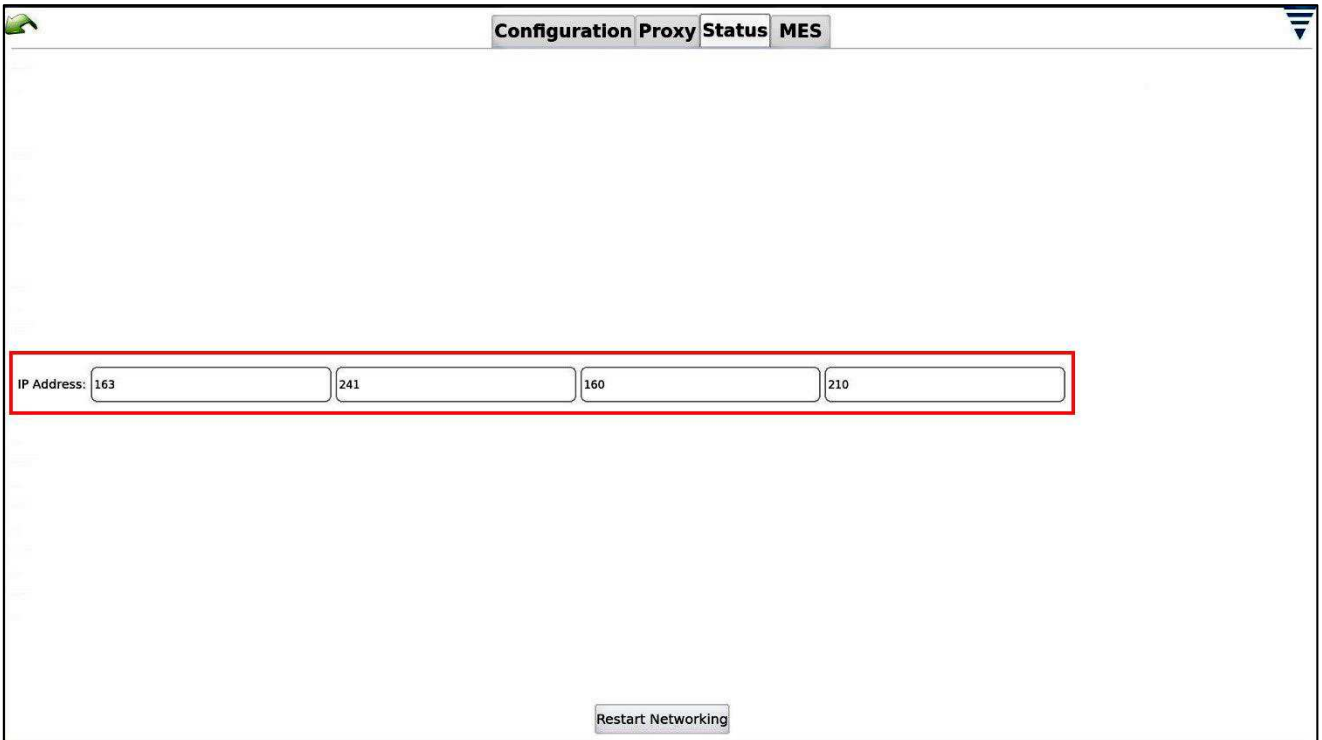

4. On the Control Panel, touch the **Remote Support** icon (Figure 58). A page with a Remote Support button in the center is displayed.
5. Touch the **Remote Support** button.
6. Give the IP address to the person who will be accessing your HV-CP machine remotely.

H. Configuring locale settings

Touch the **Locale** icon on the Control Panel to configure the locale settings (Figure 60).

Figure 60: Locale settings dialog

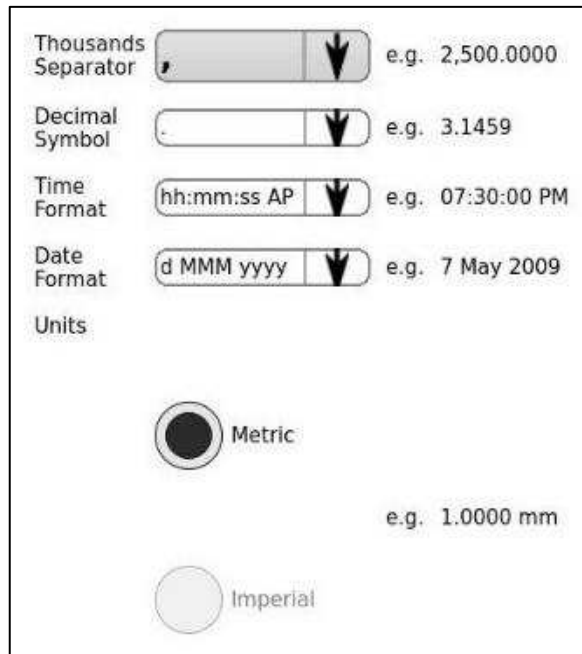

Table 7 describes the locale settings.

Table 7: Locale settings

Setting	Description
Thousands separator	Selects the character displayed between groups of digits in large numbers.
Decimal symbol	Selects the character displayed between the ones digit and the tenths digit.
Time format	Selects the format used to display times.
Date format	Selects the format used to display times.
Units	Two radio buttons select whether metric or imperial units are used.

I. Maintenance

Touching Maintenance icon on the Control Panel displays the Maintenance screen (Figure 61). The tabs on this screen enable authorized users to view information about the system and perform data maintenance.

Figure 61: Maintenance screen

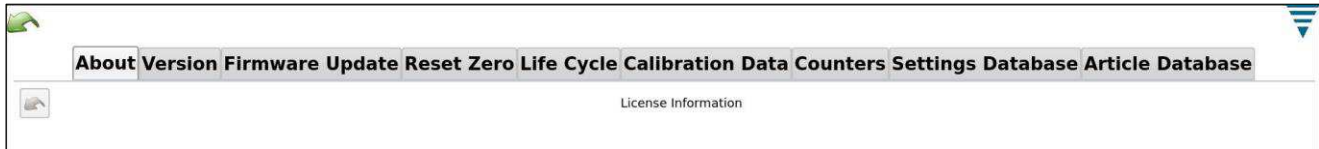

Table 8 describes the tabs on the Maintenance screen.

Table 8: Maintenance tabs

Tab	Description
About	Selected by default. Displays license information.
Version	Displays important software versions for the different types of systems used by the HV-CP. The version information can be exported to a USB flash drive as text files (see Exporting version information on page 54).
Firmware Update	Used by TE field service for updating the firmware.
Reset Zero	Used to reset the zero positions for the blades, gripper, and mandrel (see Resetting zero positions on page 55).
Life Cycle	Used for initial machine setup. For life cycling the machine enter in the number of dry cycles you would like the machine to perform and touch Run Life Cycles.
Calibration Data	Used for initial machine setup and is not needed for normal operation.
Counters	Displays the total cycle count of the machine. This counter cannot be reset.
Settings Database	Reserved for TE field service.
Article Database	Used with a USB flash-drive to export and import articles (see Article database on page 57).

I.1. Inserting a USB flash drive

The Version and Article Database tabs require the use of a USB flash drive. To use these features, insert the flash drive into one of the USB ports located in the utility alcove (Figure 62).

Figure 62: Location of USB ports

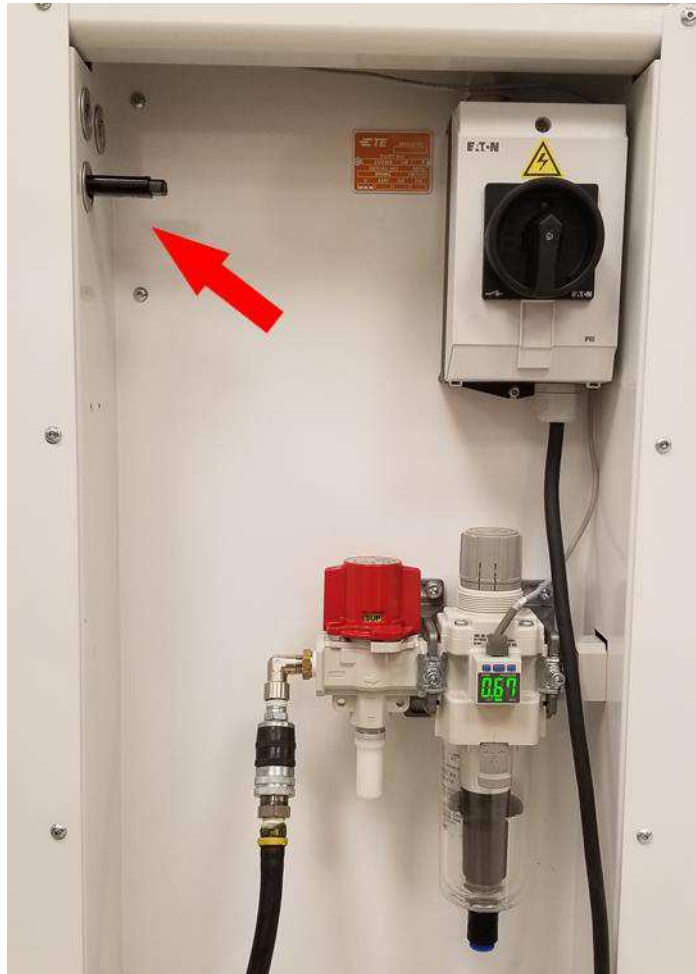

1.2. Exporting version information

You can export software version information to a USB flash drive.

1. Insert a flash drive into one of the USB ports (see **Inserting a USB flash drive** on page 53).
2. On the Control Panel, touch the **Maintenance** icon. The Maintenance screen is displayed with the About tab selected.
3. Touch the **Version** tab. The Version controls are displayed (Figure 63).
4. Touch the **Save to File** button at the bottom. The version information is exported to the flash drive as text files.

Figure 63:Version tab

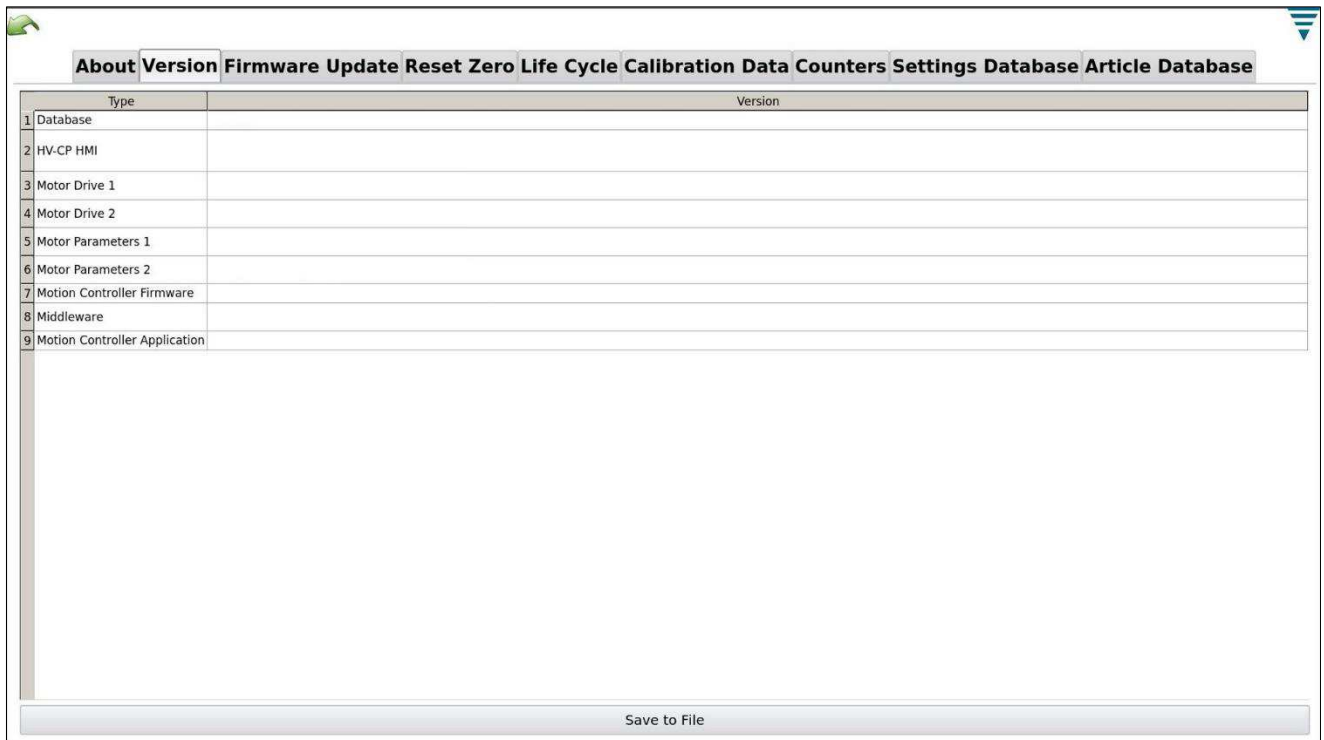

1.3. Resetting zero positions

This tab has buttons that reset the zero positions for the blades, gripper, and mandrel (Figure 64). Touch the appropriate button and follow the on-screen instructions.

Figure 64: Reset Zero tab

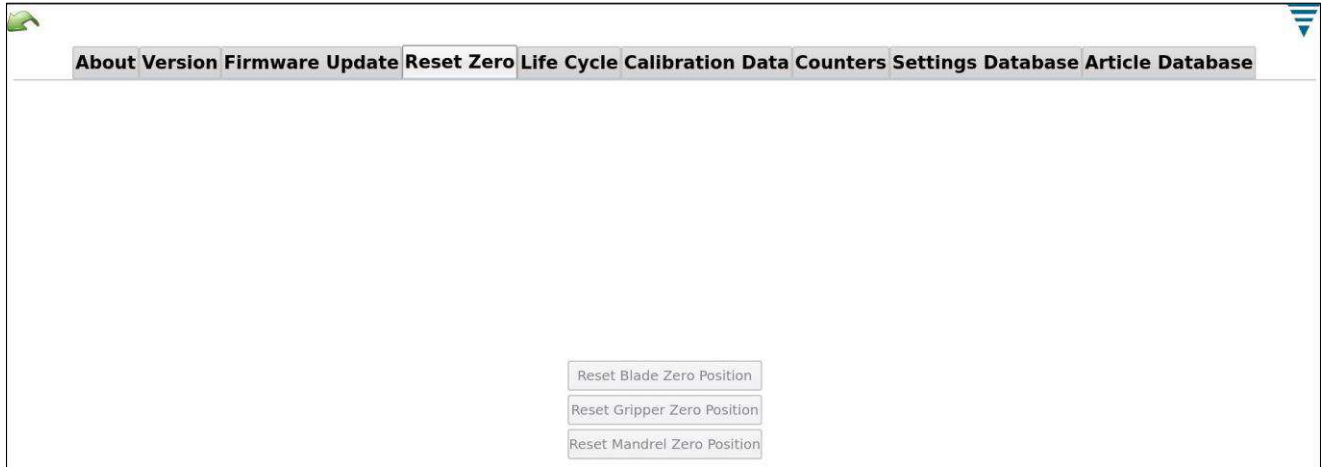

The tooling change tool (Figure 65) is required for the Reset Zero process. Insert the pin into the calibration hole (Figure 66).

Figure 65: Tooling change tool (PN 2361560-1)

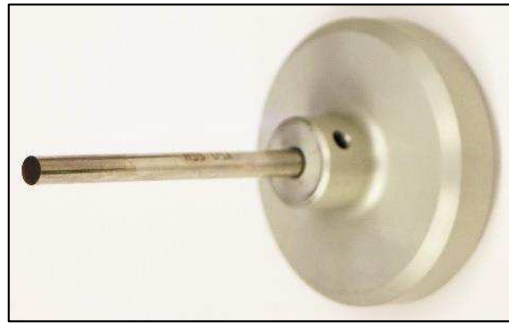
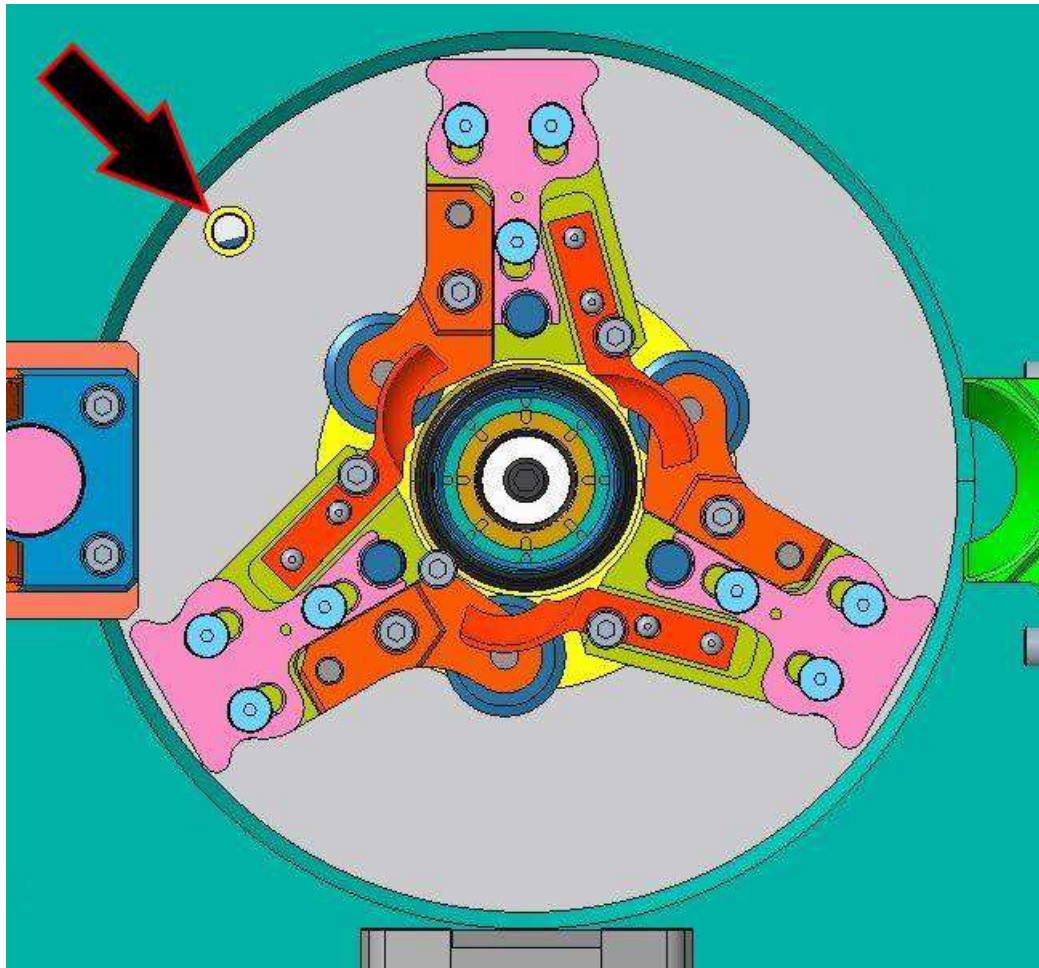

Figure 66: Calibration hole



I.4. Article database

Articles can be exported from the HV-CP to a USB flash-drive and then imported to other HV-CP machines. This allows you to save all process parameters for a given article. The files can also be emailed and copied to other USB flash-drives, allowing for quick transfer of programs from machine to machine.

Exporting an article

To export an article, complete the following steps.

5. Insert a flash drive into one of the USB ports (see **Inserting a USB flash drive** on page 53).
6. On the Control Panel, touch the **Maintenance** icon. The Maintenance screen is displayed with the About tab selected.
7. Touch the **Article Database** tab. The Article Database controls are displayed (Figure 67).

Figure 67: Article Database controls

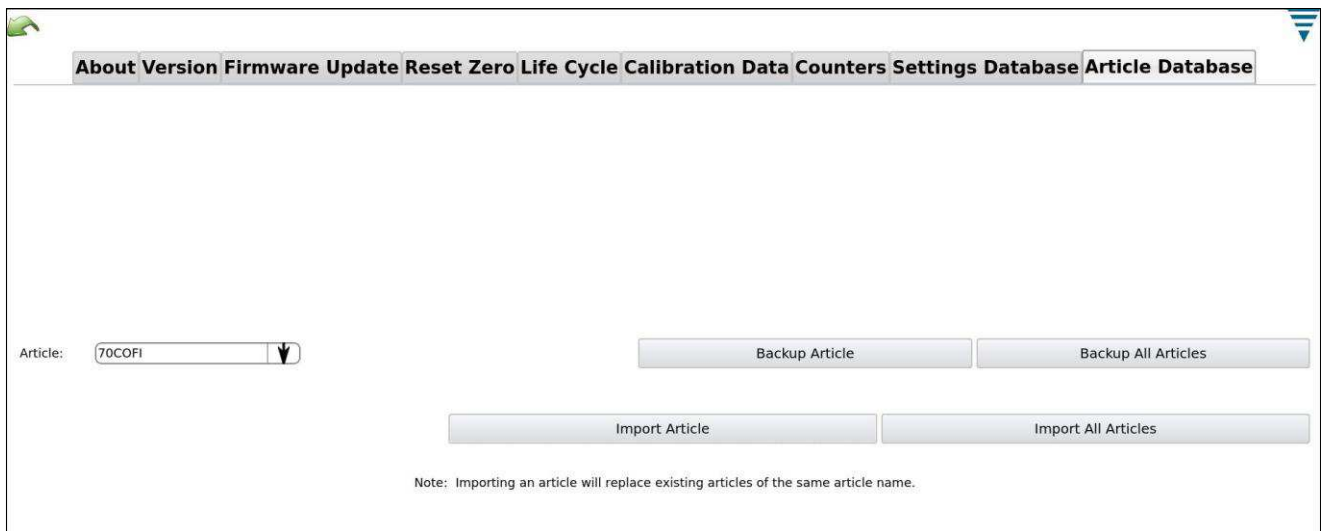

8. Select what you want to export.
 - To select all existing articles, touch the **Backup All Articles** button.
 - To select a single article:
 - a. Touch the down-arrow icon to the right of the **Article** field. A list of articles is displayed.
 - b. Touch the article you want to export.
 - c. Touch the **Backup Article** button.

The export controls are displayed (Figure 68).

Figure 68: Export controls

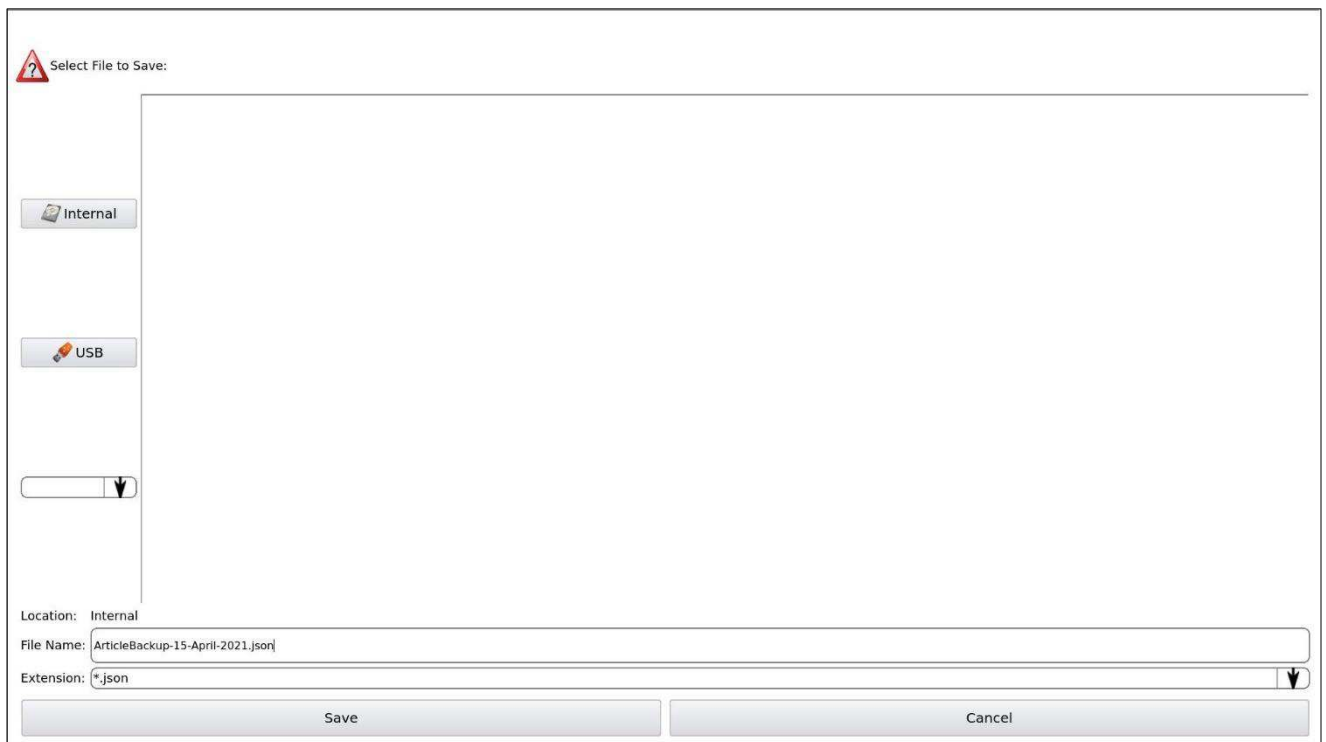

9. Touch the **USB** button.
10. Touch the **File Name** field.

11. Enter the name of the file on the flash drive where the article data will be saved (Figure 69).

**NOTE**

The file name **must** end with the JSON extension. For example, if you want to export the article data to a file named Example, you **must** enter: Example.json

**CAUTION**

A date stamp is automatically added to the filename, as shown in Figure 69. If you save to the same file more than once on the same day, the existing file is overwritten. To avoid this, enter a different filename.

Figure 69: Entering the filename

Location:	USB
File Name:	ArticleBackup-15-April-2021.json
Extension:	*.json
Save	

12. Touch the **Save** button. The article data is exported. A message confirms that the export is completed.

13. At the top of the screen, touch the **Eject** button. A message confirms that the flash drive has been ejected and can be safely removed from the USB port.

**CAUTION**

Failure to eject the flash drive before removing it can cause file corruption and data loss.

Importing an article

To import an article, complete the following steps.

1. Insert the flash drive containing the exported article into one of the USB ports (see **Inserting a USB flash drive** on page 53).
2. On the **Article Database** tab (Figure 67), touch the **Import Article** button.
 - To import all articles stored on the flash drive, touch the **Import All Articles** button.
 - To import a single article, touch the **Import Article** button.

The import controls are displayed (Figure 70).

Figure 70: Import controls

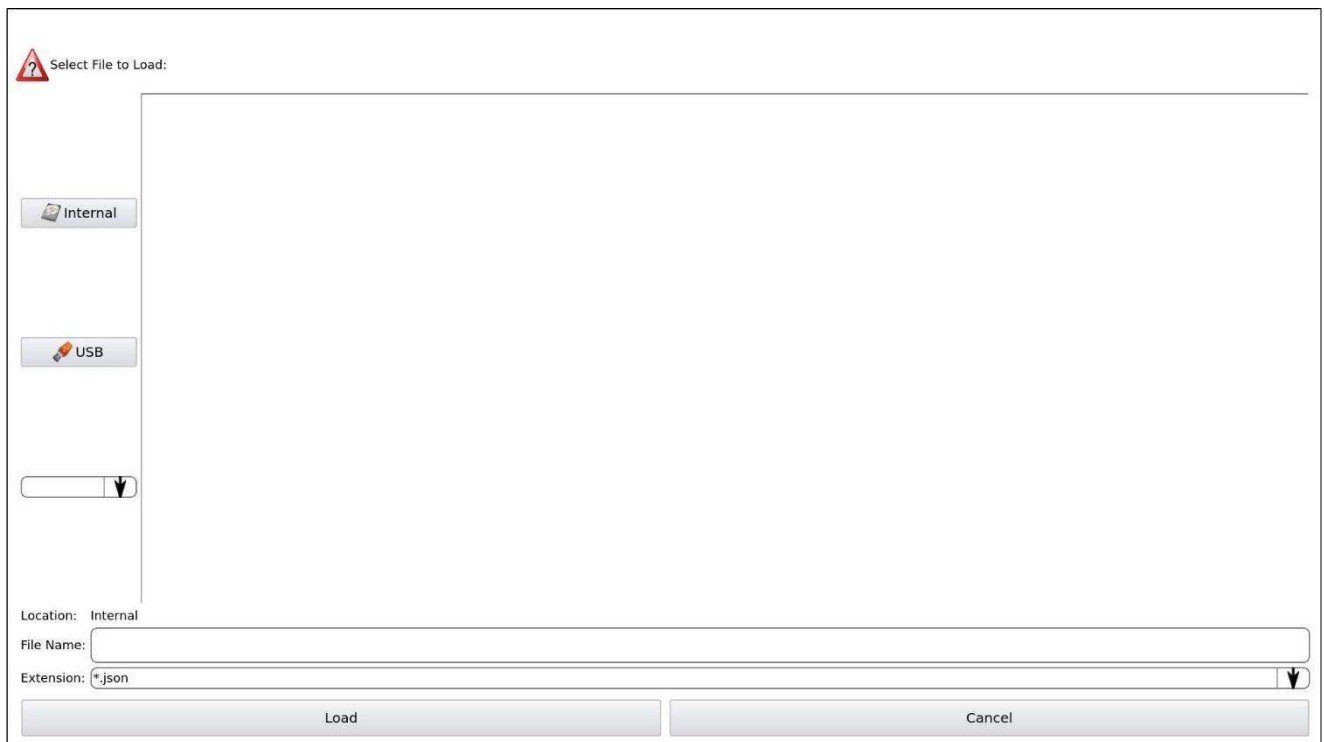

3. Touch the **USB** button. A list of the JSON files on the flash drive is shown.
4. If you are importing a single article, select the JSON file for that article.



CAUTION

If the machine already has an article with the same name as the one you are importing, the existing article is overwritten and cannot be recovered.

14. Touch the **Load** button. The article data is imported. A message confirms that the import is completed.
15. At the top of the screen, touch the **Eject** button. A message confirms that the flash drive has been ejected and can be safely removed from the USB port.



CAUTION

Failure to eject the flash drive before removing it can cause file corruption and data loss.

J. Configuring network settings

Touching the **Network** tab on the Tool Bar displays the network configuration screen. This screen has four tabs

- **Configuration** (selected by default)
- **Proxy**
- **Status**
- **MES**

These tabs are used to configure the HV-CP on your LAN. Features of the HV-CP that require this functionality are

- Manufacturing Execution System (MES)
- Network time server
- Remote troubleshooting components

Consult your Information Technology provider for details on configuring the HV-CP on your network.



NOTE

The machine's IP address is needed for remote support (see **Configuring remote support** on page 50). To view the IP address, click the **Status** tab.

K. Feature activation

Used with model 2335400-2 only.

L. Login/Logout

This screen is used for switching between users.

1. Touch the icon to select the Login/Logout screen. The user that is logged on will be displayed.
2. Choose Logout to select a new user.
3. Choose the new user from the dropdown list.
4. Enter the password for that user. If no password is selected, none is needed to Login/Logout of the system.



NOTE

The system initially has only a single User (the Administrator), and no password is required. After other users are added, or a password is entered for the Administrator, a password is required to Login/Logout of the system. If the password is lost, contact TE Tooling at (800) 522-6752.

M. Diagnostics

The Diagnostics screen provides access to the options listed in Table 9.

Table 9: Diagnostics options

Option	Description
CANopen Nodes	Reserved for TE field service.
Process Options	Touch any of the buttons to turn systems off or on. When a button is solid, the system is on. Turn off all systems when operating the machine normally.
System I/O	Tests different functionalities of the machine. Provides information on the positions of the three axes for troubleshooting purposes.

5.3. Initial startup

A. Powering up

The main power disconnect is mounted on the left side of the machine (see Figure 4). Turning the switch to the OFF position disconnects the incoming power. It can be locked out for safety and security purposes. Turn it to the ON position to start the machine. The machine powers up accordingly. With electricity to the machine, the pneumatic pressure switch reads the pressure entering the machine. The machine does not run if the pressure value on the pneumatic pressure switch is too high or too low. Refer to Table 2 for the correct pressure.

B. Logging in

To log into the machine, complete the following steps.

1. On the Control Panel (Figure 51), select **Login/Logout**. A login dialog is displayed (Figure 71).

Figure 71: Login dialog

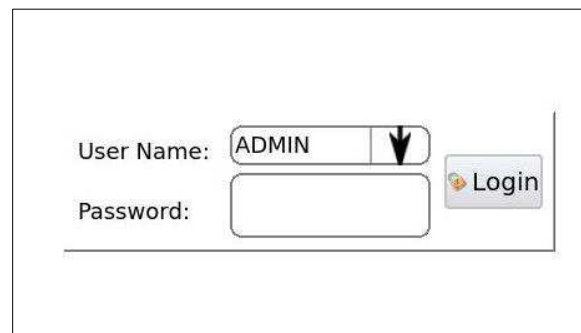

The login dialog box is a rectangular window with a white background and a thin black border. It contains two input fields and a button. The first field is labeled 'User Name:' and contains the text 'ADMIN'. To the right of this field is a small dropdown menu with a downward-pointing arrow. The second field is labeled 'Password:' and is currently empty. To the right of the password field is a button labeled 'Login' with a small icon to its left.

2. Touch the menu button and select the appropriate user name.
3. Enter the password and touch the **Login** button.

5.4. Processing

Typically, day-to-day processing consists of the following operations:

- Selecting an article
- Creating an article
- Modifying an article
- Standard operation (production)
- Importing/exporting articles via USB flash drive

A. Selecting an article

To select an article, complete the following steps.

1. In the upper left corner of the screen, touch the menu button to the left of the **Name** field (Figure 72). A menu is displayed, listing the names of existing cables on the machine.
2. Touch a name to select that article. The machine updates parameters and is ready for production use.

Figure 72: Article dialog

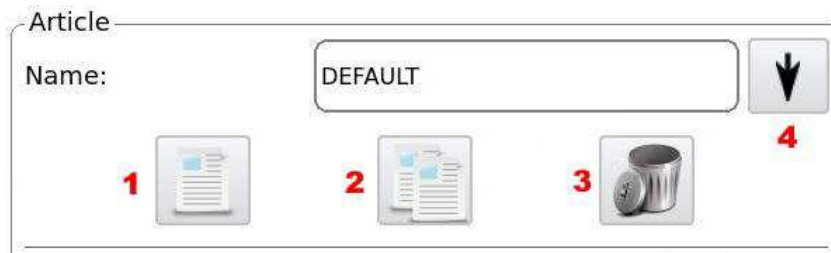

- 1** New article button
- 2** Copy article button
- 3** Delete article button
- 4** Menu button

B. Creating an article

A user must have Operator D permissions (see Table 6) to create an article. You can create an article by specifying all the parameters, or by copying an existing article and changing only the parameters that are different.

1. On the right side of the Production screen, in the Operational Mode box, touch the Setup Mode radio button (Figure 73).

Figure 73: Operational Mode radio buttons

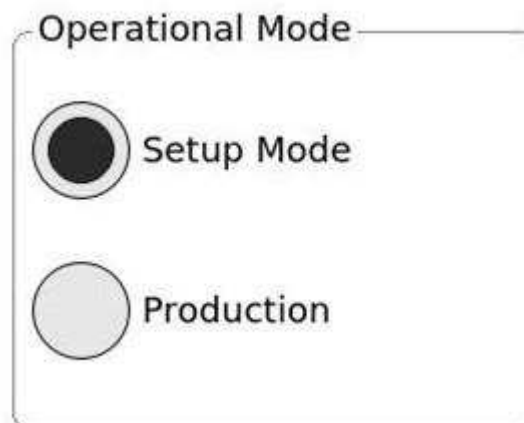

2. In the upper left corner of the screen (Figure 72), do one of the following:
 - Touch the **New Article** button.
 - Select an existing article and touch the **Copy Article** button.

In the steps that follow, enter or change values as needed. If a field has a menu button (see Figure 72), touch that button to display a menu of available values.

3. Enter a unique name for the article (up to 25 characters).

4. In the **Process Type** field, touch the menu button and select a process type.
 - **Process Type I** is the default value. Use this process type if possible. It provides a shorter cycle time than Process Type II.
 - Use **Process Type II** with cables containing a foil layer that does not adhere to the insulation. This process type performs an additional insulation cut in a sacrificial portion of the braid, ensuring that the foil is completely cut through. This enables the machine to more easily flare the braid in the next step to prepare it for cutting.
5. In the **Import** field, select a type of cable (Figure 74). This value determines the type of cable that is displayed in the Cable Builder.

Figure 74: Selecting the cable type

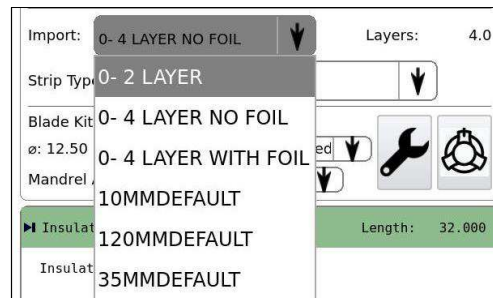

- Use **0-2 LAYER** for single insulation, single core cables.
 - Use **0-4 Layer NO FOIL** or **0-4 Layer WITH FOIL** for cables that contain two insulations, a core, and a braided shield.
3. In the **Strip Type** field, select **Full**, **Slice**, or **None** (Figure 75). These values refer to the core of the cable.

Figure 75: Selecting strip type

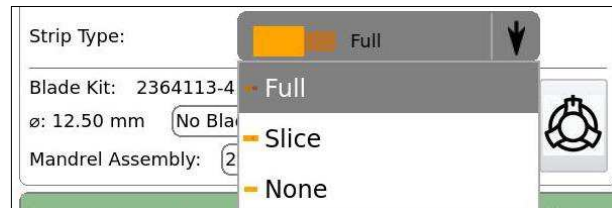

- **Full** removes the insulation completely.
- **Slice** cuts the insulation, but does not remove it.
- **None** does not process the cable core.

- In the **Blade Guides** field (Figure 76), select **No Blade Guides Installed**.

Figure 76: Blade Guides field



NOTE

Blade Guides are for specific applications. Do not use them unless TE engineering recommended doing so. Contact TE Application Tooling Engineering for questions regarding Blade Guides.

- In the Cable Builder, enter the cable layer diameters and strip lengths (Figure 77).

Figure 77: Cable Builder for Process Type I

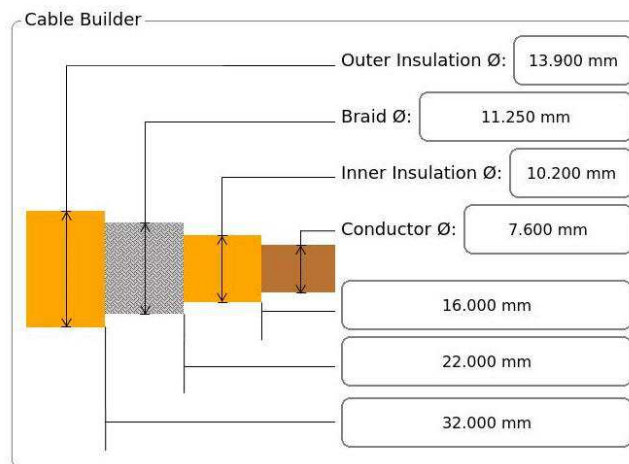

If you selected Process Type II, the Cable Builder has an additional field where you can enter the Type II cut length (Figure 78).

Figure 78: Cable Builder for Process Type II

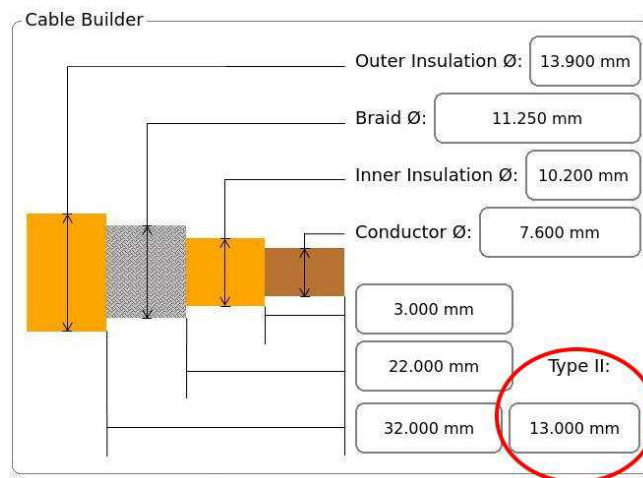

CAUTION

To avoid damaging the braid, specify a Type II cut length that is **less** than the braid cut length.

6. Calculate the **Final Braid Length** by subtracting the **Braid Strip Length** from the **Outer Insulation Strip Length**. This is shown in the on-screen keyboard when the **Braid Length** field is selected (Figure 79).

- The **Final Braid Length** must be 3 mm or greater.
- A **Final Braid Length** between 3 and 7 mm reduces the life of the mandrel.
- A **Final Braid Length** greater than 7 mm increases the mandrel wear life.

Figure 79: Entering the strip length

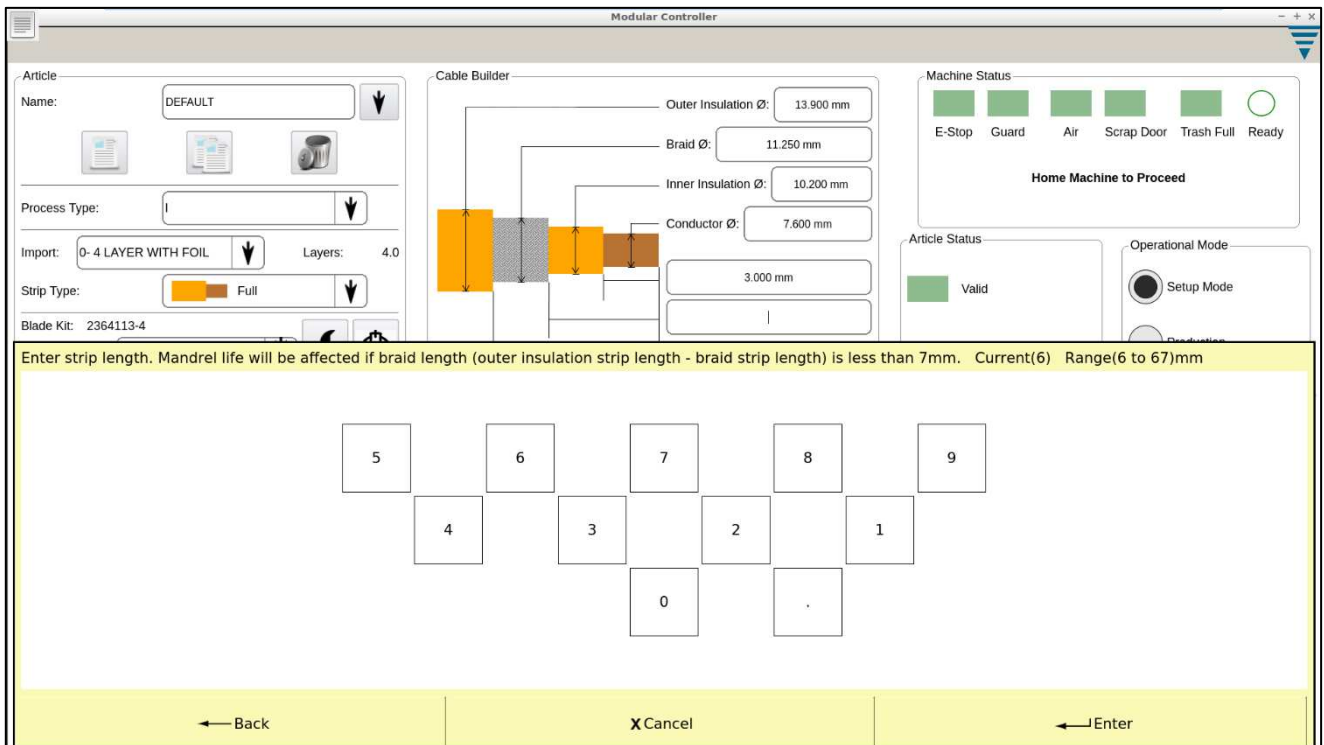

The mandrel has two independent wear zones (Figure 80) that are used depending on the **Process Type** chosen and the **Final Braid Length**. The two wear zones are needed to prevent damage to the outer insulation during the mandrel insertion step.



NOTE

The machine automatically calibrates if the operator switches between the two wear zones. This calibration is necessary for the machine to detect the differences in wear between the two zones. With this new calibration data, the machine automatically updates the braid cut depth adjustment.

Figure 80: Mandrel wear zones

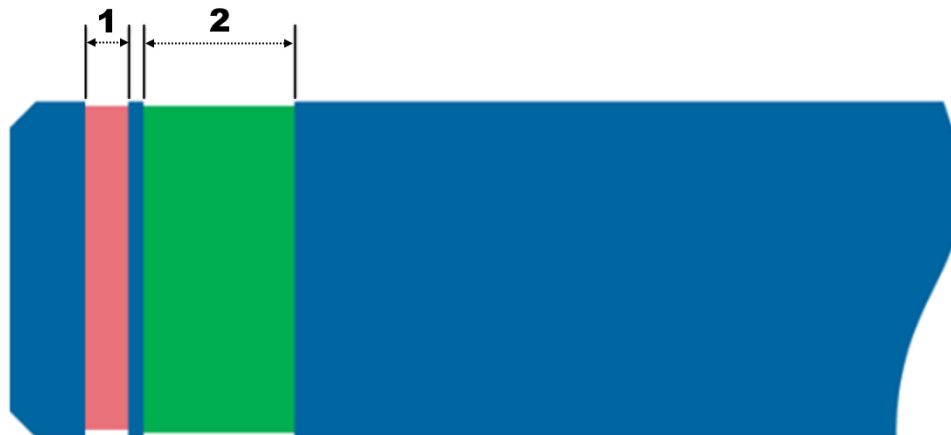

- 1 Zone A (1.0 mm)
- 2 Zone B (2.5 mm)

Table 10 indicates when each wear zone is used.

Table 10: Wear zone usage

Zone	Final Braid Length mm	Process Type
A	3-7	II
B	> 7	I

7. The Mandrel Assembly field is automatically populated with the appropriate mandrel kit, based on the cable diameters listed in the Cable Builder. In some cases, this kit can be changed if the diameters are within the range of the manual override diameters (see Table 4). Touch the menu button (Figure 81) to change the kit.

Figure 81: Menu button for Mandrel Assembly field

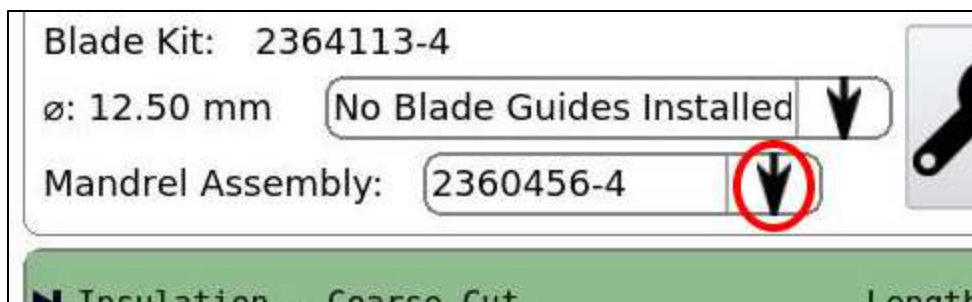

CAUTION

Selecting the wrong mandrel assembly can damage the machine or tooling.

C. Adjusting an article

Articles may require adjustment to improve the quality of the preparation. Users must have Operator D level permissions (see Table 6) to adjust an article. Use Setup Mode (Figure 78) to test adjustments to articles.

- In Setup Mode, the machine requires user input to proceed to the next step in the Process Steps (see Figure 79).
- In Production Mode, the steps are automatically started and followed sequentially.

After the cable is inserted, you can touch the Manual Start button (Figure 46) to begin the cycle. The machine always pauses after completes a step. This pause between process steps gives you the opportunity to eject the cable if the step was not completed to satisfaction.

Example: If the insulation scrap isn't completely removed from the cable during the Insulation – Wayback step, it can interfere with the Braid – Flare Braid step. The pause allows you to determine that the scrap was not completely removed and eject the cable, preventing possible damage.

1. On the right side of the Production screen, in the Operational Mode box, touch the radio button to select **Setup Mode** (Figure 82).

Figure 82: Operational Mode buttons

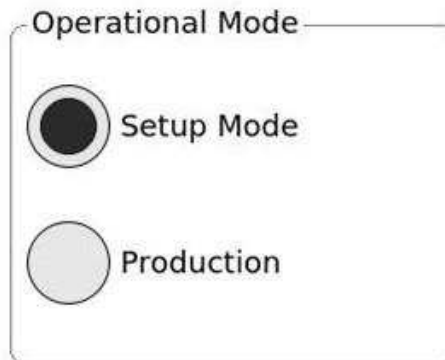

2. On the left side, in the Process Step box (Figure 83), touch the process step you want to adjust.

Figure 83: Process steps

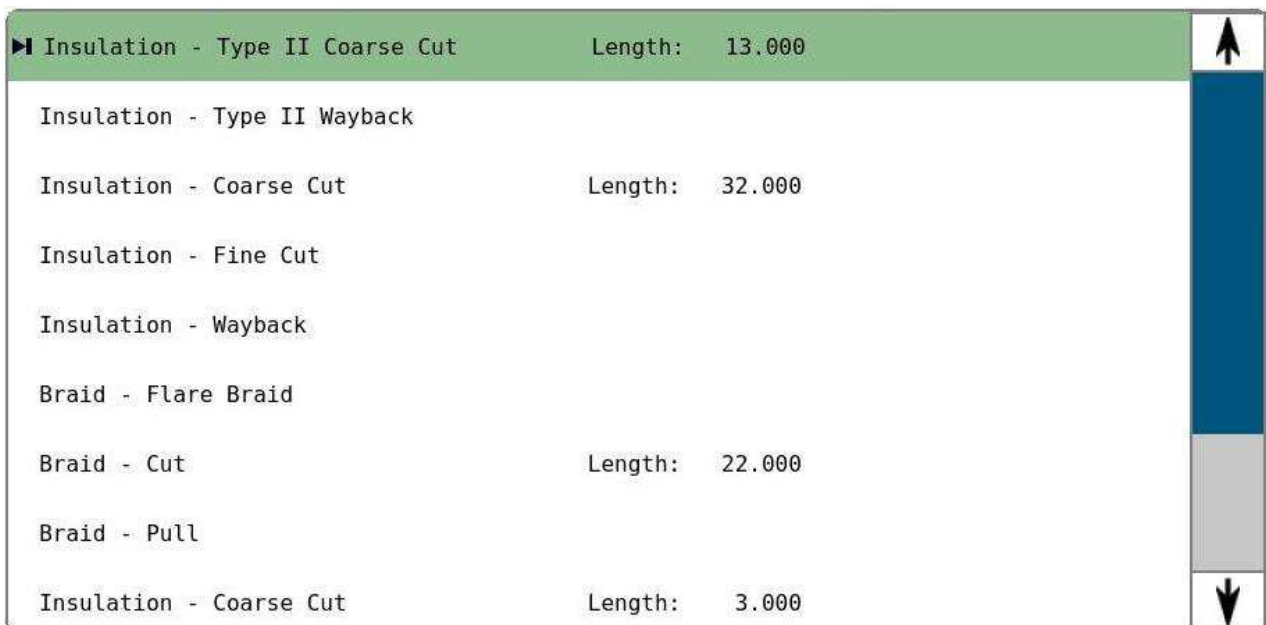

- On the right side, use the up and down Diameter Adjustment arrows (Figure 84) to set the blade and cutting wheel depths.

Figure 84: Standard settings

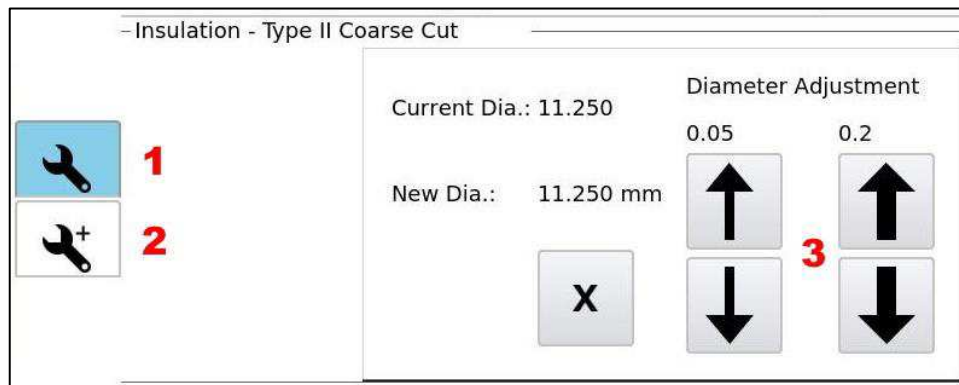

- Standard settings
- Advanced settings
- Diameter adjustment arrows



NOTE

The wrench icon with no + is highlighted in blue, indicating that Standard Settings is selected (and Advanced Settings is not).

- When the Braid – Cut step is selected, you can also select an Auto Adjust Type (Figure 85). The machine automatically adjusts the braid cut depth based on the Type selected. The frequency of the automatic adjustments is determined by the machine, based on the type selected and other article data. If **None** is selected, the machine does not make any automatic adjustments.

Figure 85: Braid Auto Adjust Type

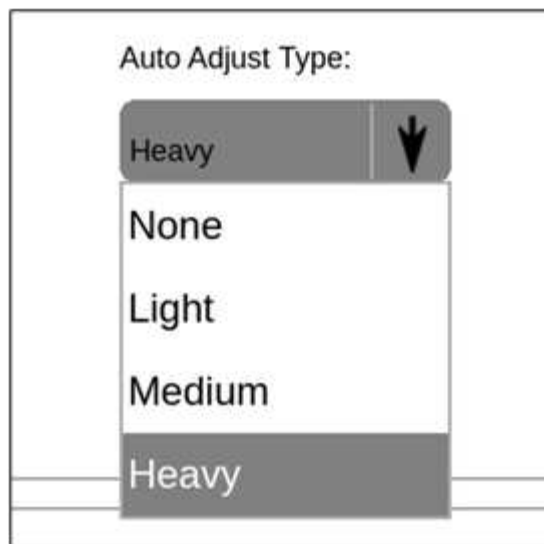

- When changes are complete, switch the Operational Mode to Production (Figure 82).



NOTE

The machine must be Homed before it allows another cycle to run.



NOTE

When tooling is changed, an article adjustment/verification will need to be performed to ensure the parameters have not changed to continue with the production run of the article. Verification is automatic, and status is displayed on the production screen.



NOTE

You can adjust the strip lengths by editing the fields in the Cable Builder (Figure 77 and Figure 78).



NOTE

Insulation – Type II Coarse Cut, Insulation – Coarse Cut (outer insulation), and Insulation – Coarse Cut (inner insulation) all use independent Diameter Adjustments identical to the one shown in Figure 84.



CAUTION

Scrap can get stuck in the machine or scrap tube, especially when testing a new cycle. If this happens, you must stop the cycle, shut off and lock out the main power switch (Figure 4) and air valve (Figure 6), and then clear the scrap from the machine area, the blades, or the scrap tube to ensure nothing jams or causes damage to the blades, wheels, or cutting arms.

D. Advanced Settings

The Advanced Settings option if additional adjustments are necessary after all adjustments in the standard setup mode have been attempted. The parameters that can be edited for each step in the process are displayed when that step is selected in the Process Steps box (Figure 83).

To select Advanced Settings, touch the **Wrench +** icon. The icon is highlighted in blue (Figure 86) to indicate that the Advanced Settings are selected.

D.1. Insulation – Type II Coarse Cut

Figure 86 shows the advanced settings for Insulation – Type II Coarse Cut.

Figure 86: Advanced settings for Insulation – Type II Coarse Cut

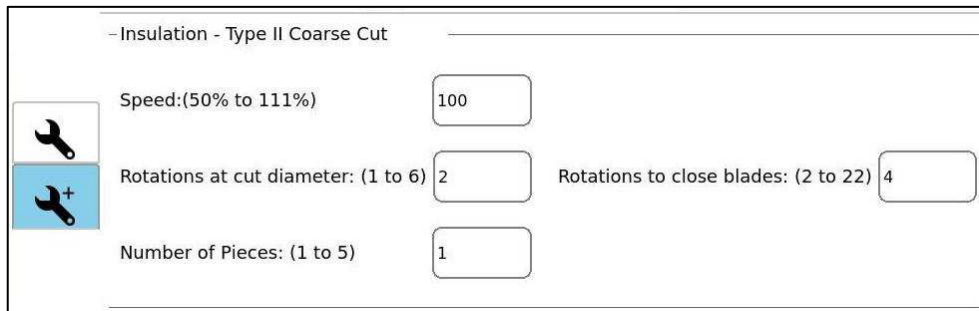

The advanced settings for Insulation – Type II Coarse Cut are listed in Table 11. These settings all relate to the current diameter, which is controlled by the Settings for each process step (Figure 84).

Table 11: Advanced settings for Insulation – Type II Coarse Cut

Setting	Description
Speed	The speed at which the cutting arms rotate around the cable.
Rotations at cut diameter	The number of times the cutting arms rotate at the current diameter.
Rotations to close blades	The number of rotations the cutting arms take to reach the current diameter from their home position.
Number of pieces	<p>The number of cutting operations the machine performs on each layer.</p> <ul style="list-style-type: none"> • Set to 1 for the best cycle time. • Increase the value when scrap pieces become too large to successfully remove, or when scrap removal becomes an issue.

D.2. Insulation – Fine Cut

Figure 87 shows the advanced settings for Insulation – Fine Cut.

Figure 87: Advanced settings for Insulation – Fine Cut

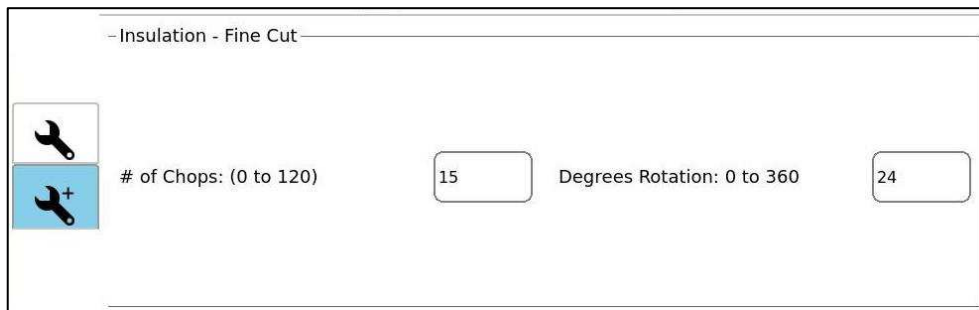

The advanced settings for Insulation – Fine Cut are listed in Table 12. These settings all relate to the current diameter, which is controlled by the Settings for each process step (Figure 84).

Table 12: Advanced settings for Insulation – Fine Cut

Setting	Description
# of Chops	The number of times the blades move towards the central axis of the cable in a chopping motion. This unique cutting motion prevents the countour blades from damaging conductor strands.
Degrees Rotation	The angle distance between chops.

D.3. Insulation – Wayback

Figure 88 shows the advanced settings for Insulation – Wayback.

Figure 88: Advanced settings for Insulation – Wayback

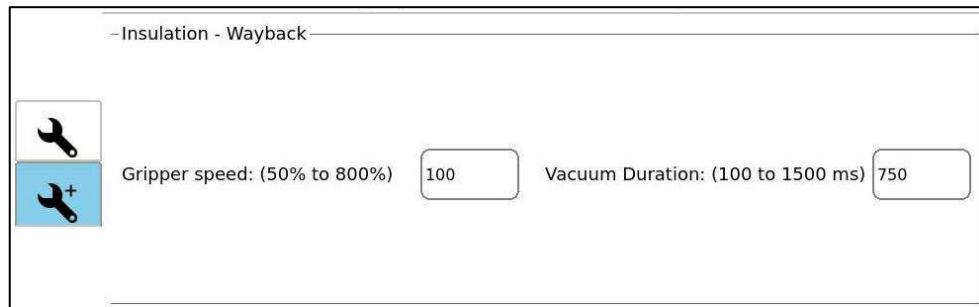

The advanced settings for Insulation – Wayback are listed in Table 13. These settings all relate to the current diameter, which is controlled by the Settings for each process step (Figure 84).

Table 13: Advanced settings for Insulation – Wayback

Setting	Description
Gripper speed	The speed at which the gripper pulls the insulation jacket off the cable.
Vacuum duration	The amount of time that the vacuum is turned on. Increase this value if scrap pieces are larger.

D.4. Braid – Flare Braid

Figure 89 shows the advanced settings for Braid – Flare Braid.

Figure 89: Advanced settings for Braid – Flare Braid

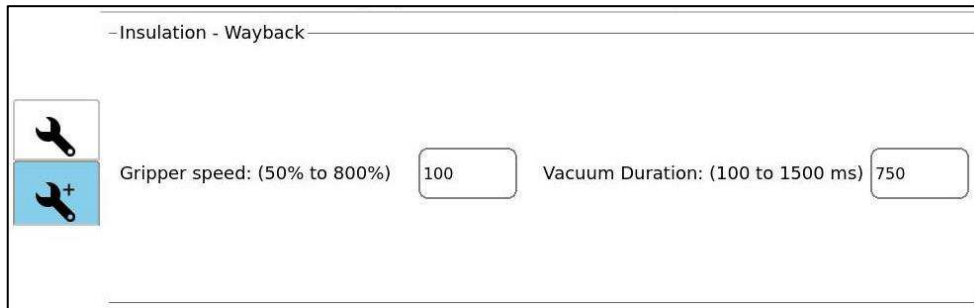

The advanced settings for Braid – Flare Braid are listed in Table 14. These settings all relate to the current diameter, which is controlled by the Settings for each process step (Figure 84).

Table 14: Advanced settings for Braid – Flare Braid

Setting	Description
Speed	The speed at which the cutting wheels rotate around the cable.
Rotations to close blades	The number of rotations the cutting wheels take to reach the current diameter from their home position.
Rotations at flare diameter	The number of times the cutting wheels rotate at the current diameter.
Gripper move	The amount the gripper translates during the flaring operation.

D.5. Braid – Cut

Figure 90 shows the advanced settings for Braid – Cut.

Figure 90: Advanced settings for Braid – Cut

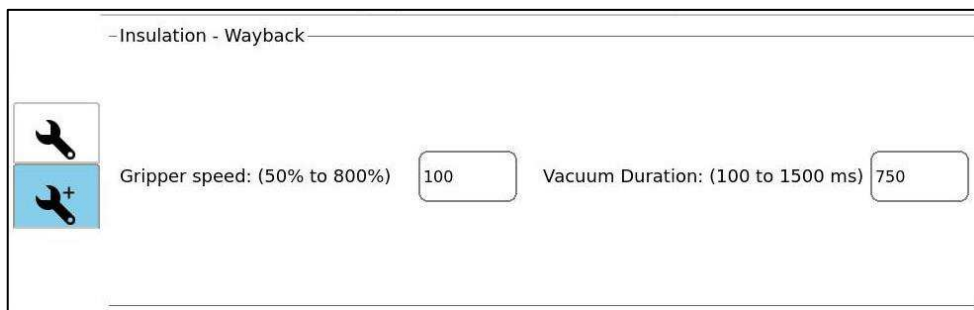

The advanced settings for Braid – Cut are listed in Table 15. These settings all relate to the current diameter, which is controlled by the Settings for each process step (Figure 84).

Table 15: Advanced settings for Braid – Cut

Setting	Description
Speed	The speed at which the cutting wheels rotate around the cable.
Rotations to close blades	The number of rotations the cutting wheels take to reach the current diameter from their home position.
Rotations at flare diameter	The number of times the cutting wheels rotate at the current diameter.
Gripper move	The amount the gripper translates during the flaring operation.

D.6. Braid – Pull

Figure 91 shows the advanced settings for Braid – Pull.

Figure 91: Advanced settings for Braid – Pull

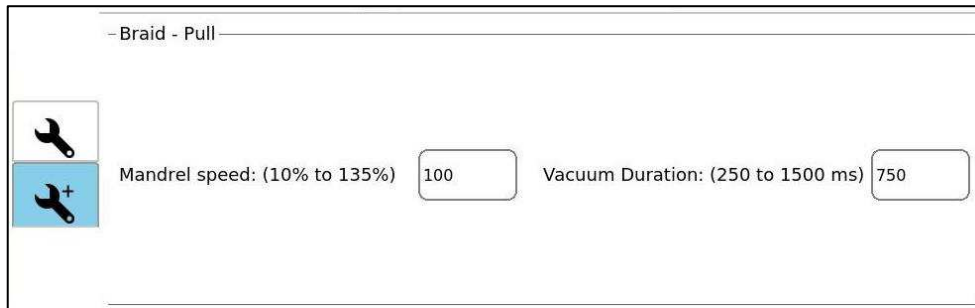

The advanced settings for Braid – Pull are listed in Table 16. These settings all relate to the current diameter, which is controlled by the Settings for each process step (Figure 84).

Table 16: Advanced settings for Braid – Pull

Setting	Description
Mandrel speed	The speed at which the mandrel is removed from underneath the braided shield.
Vacuum duration	The amount of time that the vacuum is turned on. Increase this value if scrap pieces are larger.

D.7. Partial Pull

Figure 92 shows the advanced settings for Partial Pull.

Under the final Insulation – Wayback Advanced Settings, operators can select Partial Pull by touching the radio button (Figure 92). When Partial Pull is selected, the inner insulation is cut at the inner insulation strip length and removed by the amount entered in the **Length** field. This is useful in production lines where the core strands need protection between stations.

Figure 92: Advanced settings for Partial Pull

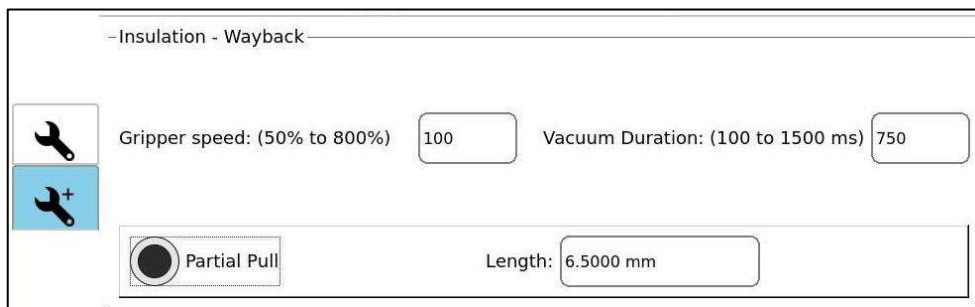

NOTE

When Partial Pull is activated, post-touch verification is automatically disabled.

E. Deleting an article

To delete an article, complete the following steps.

1. Touch the menu button.
2. Select the article.
3. Touch the **Delete Article** button.



NOTE

Deleting an article is not reversible.

F. Production status

In the upper right corner of the Production screen, the Article Status and Machine Status areas (Figure 93) provide individual status indicators for key functions of the machine and the article. If all functions are in good standing, all indicators are green and the circular indicators are filled for **Valid** and **Ready**. The indicators for Article Status ensure that the machine is capable of processing that article with the current settings. The machine status indicators ensure that the machine has the proper air, interlocks, and guarding, and has been properly homed.

Figure 93: Production status

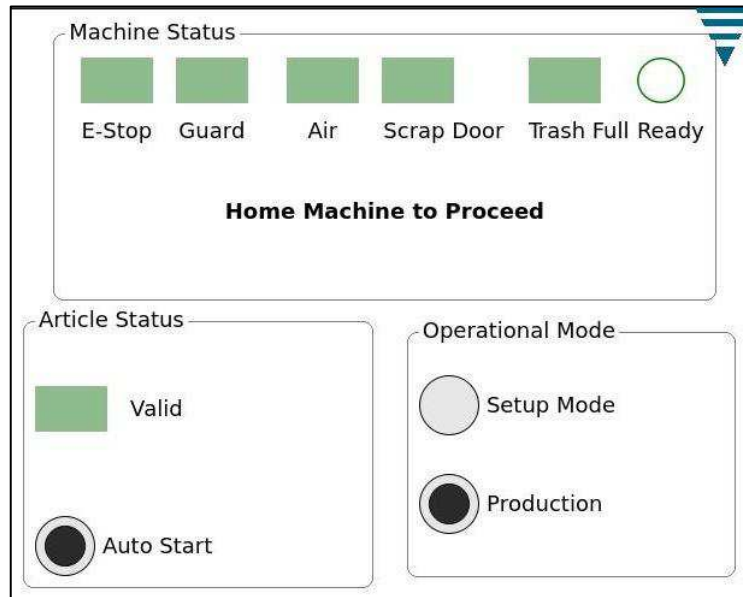

6. MAINTENANCE

6.1. Daily maintenance

- All surfaces should be kept clean and free of dust buildup. Remove accumulated dirt and debris with a soft brush. Use a vacuum to remove accumulated dirt and debris from the left and right linear actuators (Figure 94). Wipe all exposed flat surfaces with a soft cloth.

Figure 94: Linear actuators

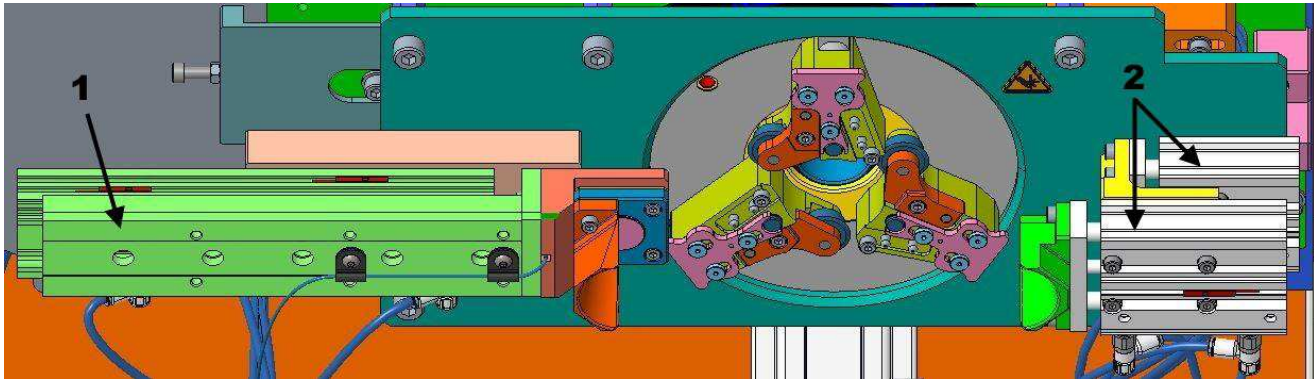

- 1** Left linear actuator
- 2** Right linear actuators

- Periodically examine the scrap bin. If the bin is full or scrap is not being removed from the work area, remove the cover on the bin and empty the scrap.



Always wear approved eye protection when removing the cover on the scrap bin and emptying the scrap.



DANGER

Always wear appropriate personal protective equipment when removing loose debris.

- Inspect contour blades for nicks, gouges, or burrs. Blades must be changed between different cable types and after a certain amount of usage. For contour blade removal and replacement, refer to section 6.3.C.



DANGER

Contour blades are extremely sharp. Handle with caution.

- Inspect cutting wheels for nicks, gouges, or burrs. Wheels must be changed after a significant amount of usage (but **not** between different cable types). For cutting wheel removal and replacement, refer to section 6.3.D.



DANGER

Cutting wheels are extremely sharp. Handle with caution.

- Inspect the mandrel for nicks, gouges, or burrs. The mandrel must be changed between different cable types and after changes in the mandrel affect the quality of the braid cut. The mandrel is considered a recommended spare part (see Table 4 for mandrel part numbers). For mandrel removal and replacement, refer to section 6.3.E.



DANGER

The end of the mandrel is sharp. Handle with caution.

6.2. Monthly maintenance

Clean and lubricate the following components with NLGI#2 EP grease:

- Sliders (door counterweights)
- Change arm assemblies

6.3. Tooling changeover



DANGER

Tightening or loosening bolts on the face of the pulleys can cause the mechanism to move. Be careful where you place your hands when changing tooling.



Complete the Lock Out/Tag Out procedure before you begin the tooling changeover.

Changeover tooling is stored in the tooling holder, which is located inside the machine behind the scrap door (Figure 95).

Figure 95: Location of tooling holder



The mandrel changeover tool (2359204-1) is kept in the tooling holder (Figure 96).

Figure 96: Mandrel changeover tool in the tooling holder



A. Preparing the machine for tooling changeover

1. Touch the **Tool Change** button (Figure 97). The machine retracts the wire clamp and cable sensor. The mandrel moves forward to its farthest outward position.

Figure 97: Tool change button

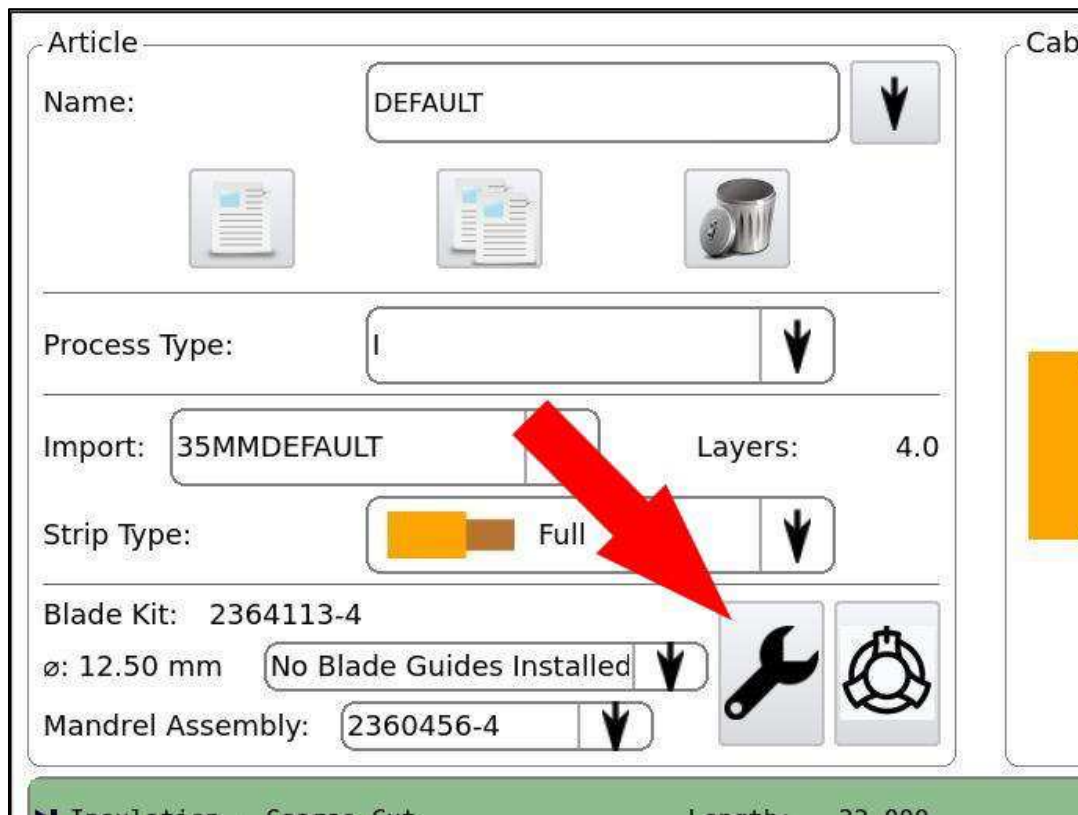

2. Rotate the main power switch to the OFF position (as shown in Figure 4) and lock it there by inserting a padlock into the locking locations.

3. Rotate the main air valve to the EXH position (as shown in Figure 6) and lock it there by installing a padlock in the locking location.



Complete the Lock Out/Tag Out procedure (steps 2 and 3) before you begin the tooling changeover.

B. Removing a quick-change arm assembly

4. Prepare the machine (see **Preparing the machine for tooling changeover** on page 77).
5. Rotate one of the quick-change arm assemblies clockwise until the installed contour blades are clear of the other arm assemblies (Figure 98).

Figure 98: Rotating a quick-change arm assembly

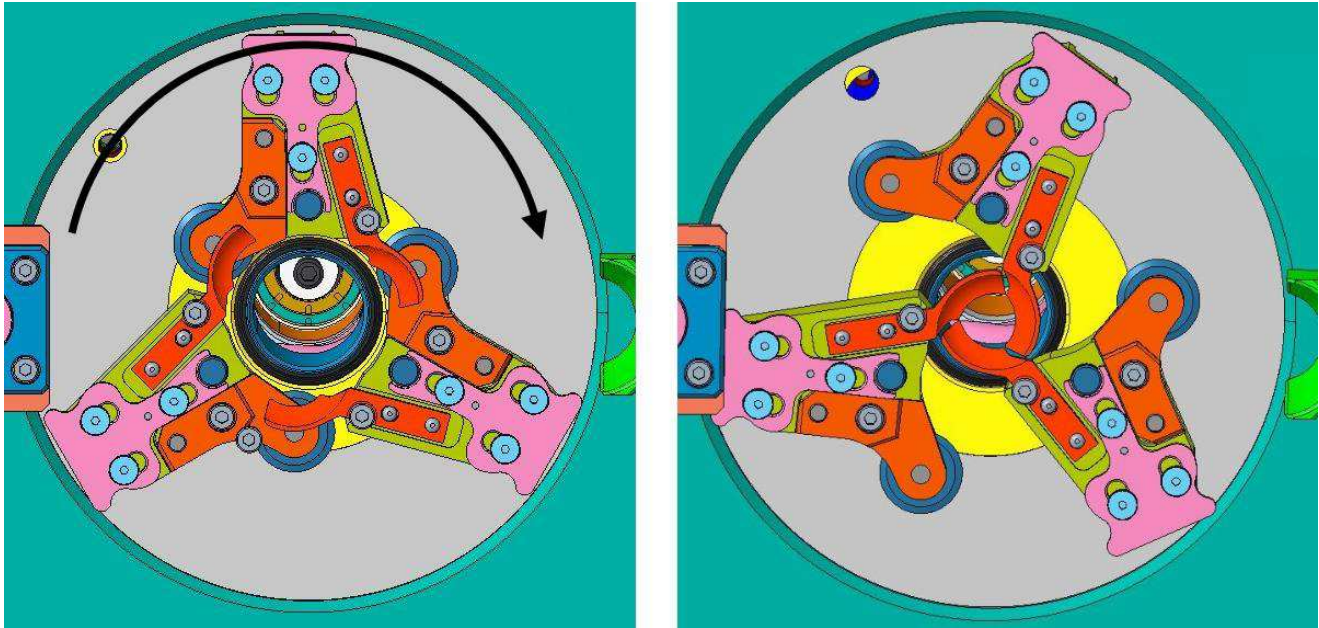

6. With one hand, grasp the locking slide (Figure 99) and pull it away from the pivot pin (Figure 100).

Figure 99: Quick-change arm assembly

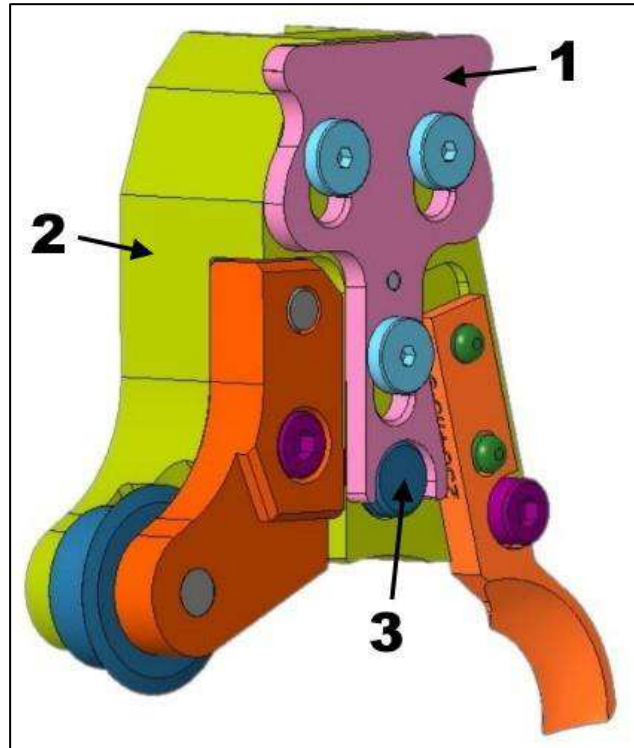

- 1 Locking slide
- 2 Cutting arm
- 3 Pivot pin

Figure 100: Pulling the locking slide

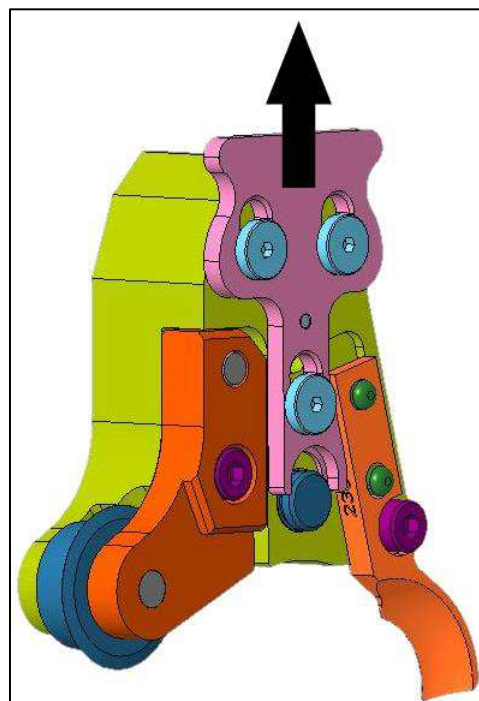

7. With the other hand, carefully pull on the cutting arm to slide the quick-change arm assembly off the pivot pin (Figure 101).

Figure 101: Sliding the assembly off the pivot pin

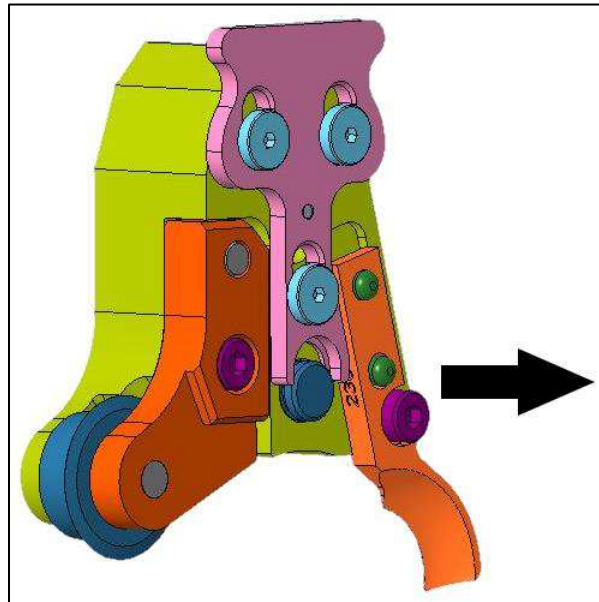

C. Replacing the contour blades



DANGER

The contour blades are extremely sharp. Handle with caution.

1. Prepare the machine (see **Preparing the machine for tooling changeover** on page 77).
2. Remove the quick-change arm assembly from the machine (see **Removing a quick-change arm assembly** on page 78).
3. While holding the cutting arm in place to prevent rotation, use a 3 mm hex-head wrench to loosen the M4 socket head cap screw (Figure 102). Do not remove the screw.

Figure 102: Removing the contour blade

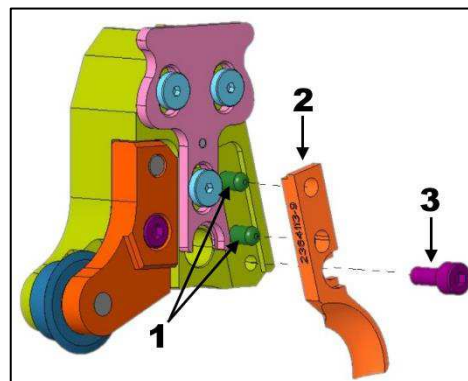

- 1** Dowel pins
- 2** Contour blade
- 3** M4 socket head screw

4. Pull the blade straight off the dowel pins and remove it from the face of the cutting arm.

**NOTE**

The rear of the contour blade has a small notch. You can help lift the rear of the contour blade by using a small screwdriver to pry at that notch.

5. Place a new blade over the dowel pins and tighten the screw securely.
6. Repeat for the other two blades.

D. Replacing the cutting wheels

1. Prepare the machine (see **Preparing the machine for tooling changeover** on page 77).
2. Remove the quick-change arm assembly from the machine (see **Removing a quick-change arm assembly** on page 78).
3. Using a 3 mm hex-head wrench, remove the M4 socket head cap screw that holds the cutting arm cap in place (Figure 103).

Figure 103: Removing the cutting wheel

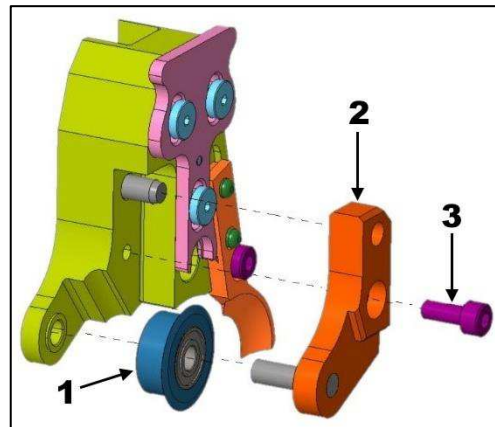

- 1 Cutting wheel
- 2 Cutting arm cap
- 3 M4 socket head screw

4. Remove the cutting wheel assembly, taking note of the wheel orientation.
5. Place the new cutting wheel assembly onto the cutting arm cap in the correct orientation.

**NOTE**

The cutting wheel can only be installed in one orientation. If cutting arm cap does not fit, check the orientation of the cutting wheel.

6. Carefully install the cutting arm cap onto the cutting arm.
7. Insert the M4 socket head cap screw and tighten securely.
8. Repeat for the other two wheels.

E. Replacing the mandrel

1. Prepare the machine (see **Preparing the machine for tooling changeover** on page 77).
2. Retrieve the mandrel changeover tool (Figure 104) from the tooling holder (Figure 96)

Figure 104: Mandrel changeover tool (2359204-1)

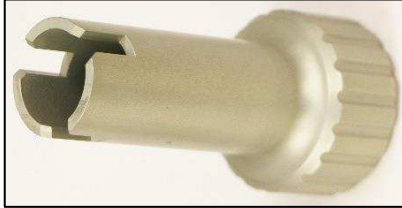

3. Place the mandrel changeover tool onto the mandrel (Figure 105). You will feel engagement as the wings of the tool go into the slots in the machine.

Figure 105: Mandrel

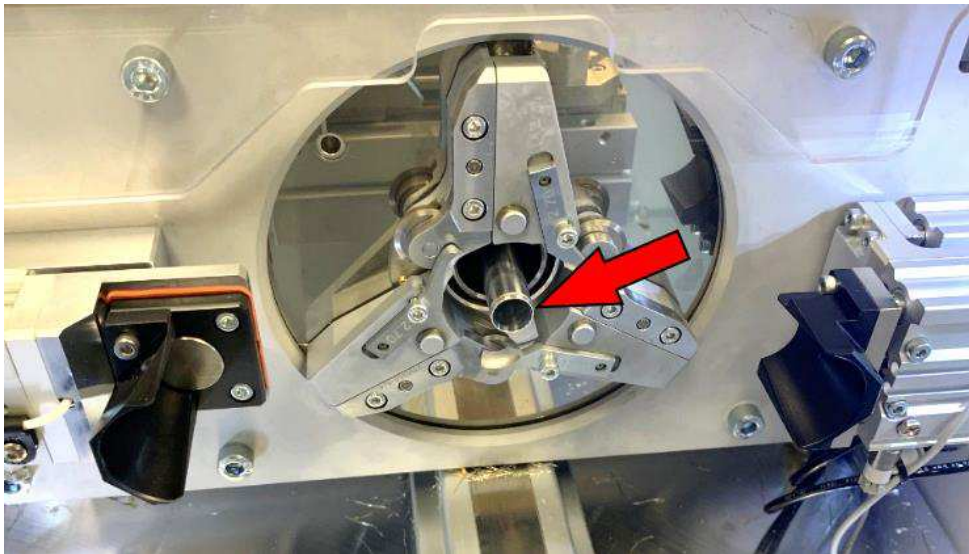

DANGER

The mandrel tip and contour blades represent dangerous cut and puncture hazards. Use **extreme** caution when working in their vicinity.

4. Turn the tool counterclockwise to loosen the mandrel.
5. Carefully remove the mandrel.
6. Place the new mandrel into the changeover tool.
7. Insert the tool and mandrel into the mandrel shaft
8. Using a torque wrench, turn the tool clockwise to tighten the mandrel to 4 Nm. Do not overtighten.

F. Replacing the blade guides

1. Prepare the machine (see Preparing **the machine for tooling changeover** on page 77).
2. Remove the quick-change arm assembly from the machine (see **Removing a quick-change arm assembly** on page 78).
3. Use a 3 mm hex-head wrench to loosen the M4 socket head cap screw (Figure 106). Do not remove the screw.

Figure 106: Replacing the blade guides

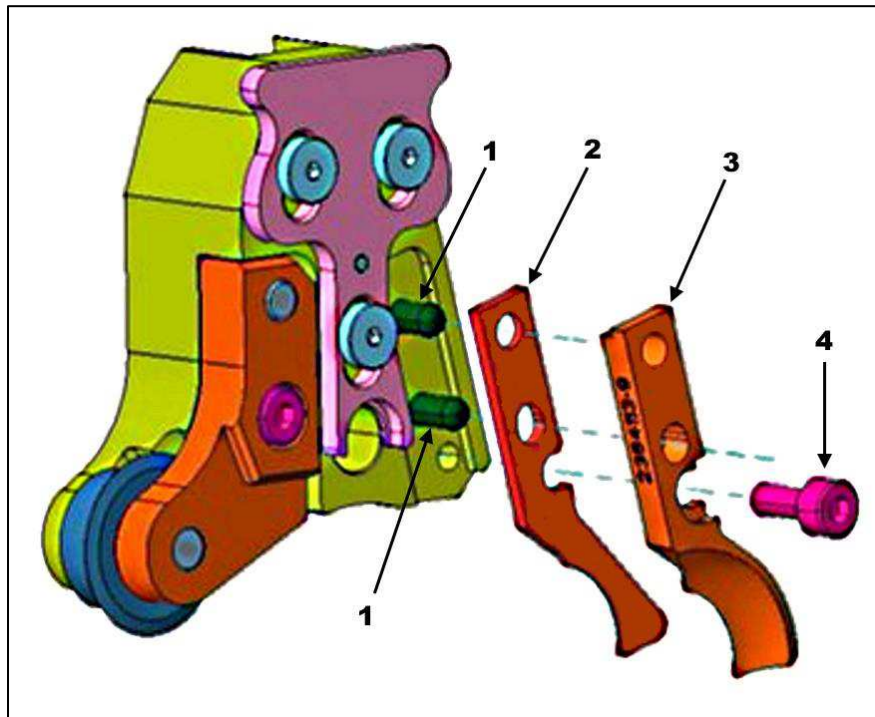

- 1** Dowel pin
- 2** Blade guide
- 3** Contour blade
- 4** M4 socket head screw

4. Pull the blade straight off the dowel pins and remove it from the face of the cutting arm.
5. Pull the blade guide straight off the dowel pins and remove it from the face of the cutting arm.
6. Place a new blade guide and contour blade over the dowel pins.
7. Tighten the screw securely.
8. On the Production screen, select **Blade Guides Installed** (Figure 76).



NOTE

Blade Guides are for specific applications. Do not use them unless TE engineering recommends doing so. Contact TE Application Tooling Engineering for questions regarding Blade Guides.

G. After tooling changeover

1. Remove the padlock from the main power switch (Figure 4) and turn the switch back to the ON position.
2. Remove the padlock from the main air valve (Figure 6) and turn the switch back to the ON position.
3. Restore power to the machine.
4. Perform a calibration cycle. To begin the cycle, press the calibration button on the UI. The HV-CP automatically calibrates the tooling to ensure that the proper tooling set for the application is installed.

Figure 107: Calibration button

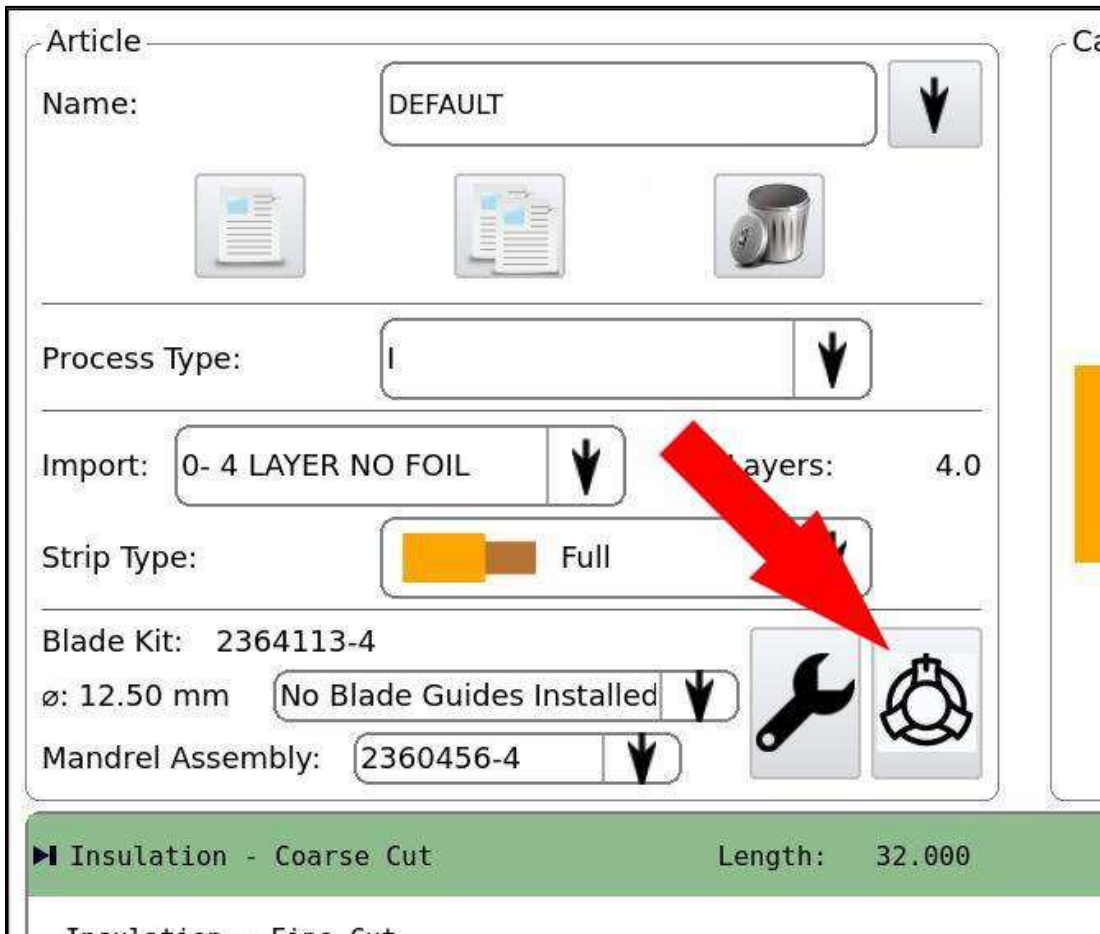

5. Dispose of removed parts in compliance with the standards in force in the country where the tool is used.

H. Tooling changeover for 50-60 mm² size cables

Due to the variance in the cable diameters, the machine selects the most appropriate tooling for the diameters provided. However, you can select another set of tooling if necessary (refer to the Manual Override column of Table 4).

Some smaller 60 mm² cables are in the 50 mm² tooling range and can work with both sets of tooling.



CAUTION

Selecting the wrong tool can cause a tooling crash or scrapped cables.

6.4. Preventive maintenance

Inspect the belts for cracks, missing teeth, or missing pieces every 250,000 cycles.



DANGER

Always turn off and lock out the main power disconnect and the pneumatic shutoff before performing maintenance on the machine.

7. TROUBLESHOOTING

Perform troubleshooting in accordance with Table 17.

Table 17: Troubleshooting

Problem	Probable cause	Solution
Cable not feeding properly	Cable end out of round	Cut the end of the cable again if the cable is severely out of round. Otherwise, squeeze the cable in your hands to return the cable to a round shape.
	Cable not straight enough – not touching sensor	Remove cable and restraighten. Re-insert cable and point any bend upwards if possible. Gravity will help straighten the cable.
Scrap tube clog	Bin full or an obstruction in tube	Empty bin or clear obstruction from the scrap tube by removing the bin and clearing the scrap above.
Misshapen or poor cuts	Dull tooling	Replace tooling.
Improper cut	Rotary head not homing	Verify homing performance by inserting tooling change tool 2361560-1 into the hole in the pulleys when homed. If the machine has properly homed, the pin will smoothly slide into the pulleys.
Sequence not correctly performed	—	Contact TE Field Service Engineering for assistance.
Loss of cycle data	—	Back up on flash drive or contact TE Field Service Engineering for assistance.

8. REPLACEMENT AND REPAIR

The parts listed in Table 18 are customer-replaceable. Stock and control a complete inventory to prevent lost time when replacement of parts is necessary. Order replacement parts through your TE representative. You can also order parts by any of the following methods:

- Go to TE.com and click the **Shop TE** link at the top of the page.
- Call 800-522-6752.
- Write to:

CUSTOMER SERVICE (038-035)
 TE CONNECTIVITY CORPORATION
 PO BOX 3608
 HARRISBURG PA 17105-3608

For customer repair services, call 800-522-6752.

Table 18: Customer-replaceable parts

Part number	Description	Number per assembly
2079454-1	Sensor	5
2030531-1	Sensor	1
2364113-1	Kit, contour blade	1
2360456-1	Mandrel assembly	1
2364114-1	Kit, cutter wheel (includes 3 cutting wheels)	1
2401200-1	Kit, quick change arm (includes 3 arms)	1

8.1. Sensor replacement

Six sensors monitor the position of the various actuators in the machine. Five of the sensors (Figure 108) are customer-replaceable. (The Braid Wiper Retract sensor is located inside the machine and is not customer-replaceable.) You might have to remove the top rear cover of the machine to replace these sensors.

Figure 108: Sensor locations

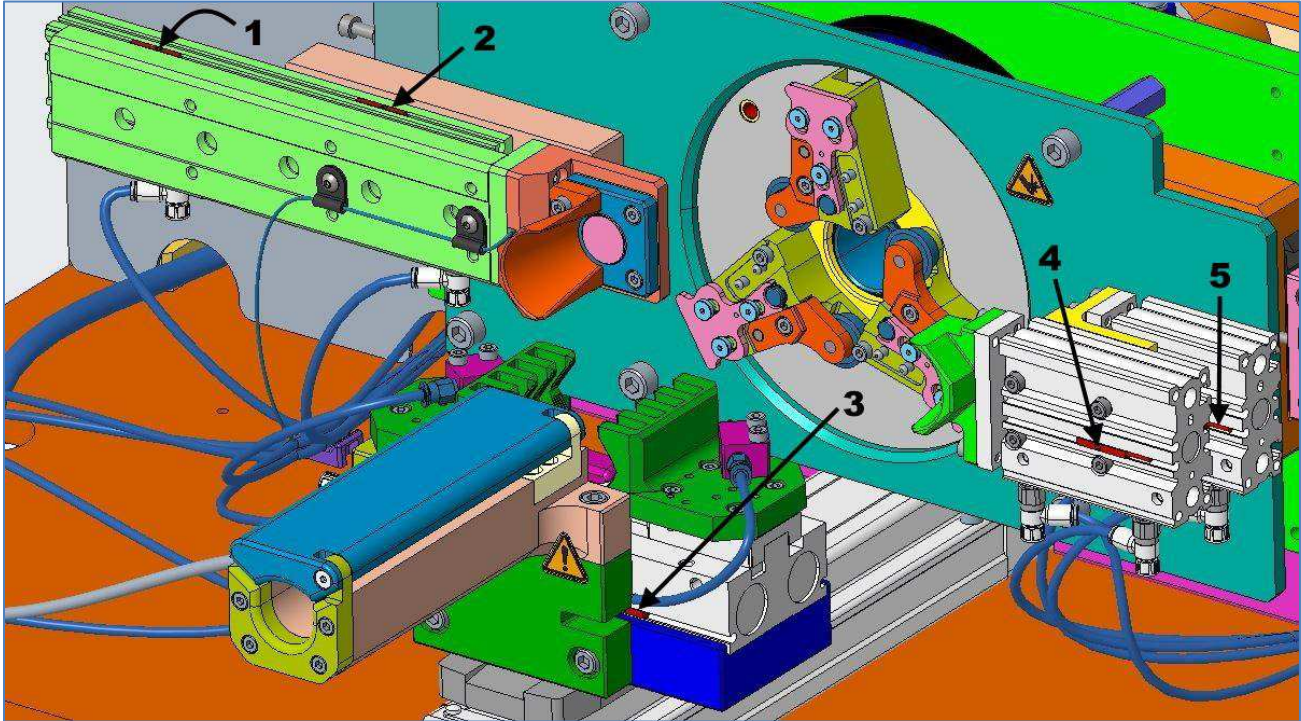

- 1 Cable gate open sensor #1
- 2 Cable gate closed sensor
- 3 Gripper open sensor
- 4 Cable gate open sensor #2
- 5 Cable gate open sensor #3



DANGER

Always turn off and lock out the Main Disconnect and the Pneumatic shutoff when performing maintenance on the machine.

1. Disconnect the sensor from the main wiring harness by unscrewing the M8 connector at the end of the sensor wire. Remove the top rear cover to gain access to the end of the sensor wire, if necessary.
2. Use a small screwdriver to loosen the sensor mounting screw.
3. Slide the sensor out of the slot in the actuator.
4. Install and connect the new sensor.
5. Re-install the top rear cover (if removed).
6. Connect power and turn on the machine.
7. Open the sliding door.
8. Move the actuator to Full OPEN or Full CLOSED position.
9. Adjust the sensor until the LED indicator is ON.
10. Tighten the sensor mounting screw to lock the sensor into position.



NOTE

The cable gate open sensors must be adjusted in numerical order (starting with #1 and ending with #3). The LED for sensor #1 must be **on** when adjusting sensor #2. The LEDs for sensors #1 **and** #2 must be **on** when adjusting sensor #3.

9. DECOMMISSIONING

A decommissioned machine must be returned to TE Connectivity for proper disposal. In compliance with the regulations in force in the country where the machine is used, the user must make sure that waste produced during operation is correctly disposed. Disposal of lubricants and removed parts must be carried out in compliance with the standards in force in the country where the tool is used.

10. REVISION SUMMARY

- Updated title.
- Updated Table 1.
- Added note about accumulator tank option on page 17.
- Added **Clamp kit (optional)** on page 20.
- Updated **Tooling** on page 28.
- Updated Table 4 and added note about part numbers.
- Updated step 7 and Figure 31 on page 31 because the foam hat is no longer used.
- Added steps 8 and 9 on page 32.
- Deleted step about plate for securing cutting arms from page 34.
- Updated information about Feature Activation in Table 5 and in section 5.2.K.
- Updated **Creating an article** on page 63.
- Added information about mandrel wear zones on page 67.
- Updated **Adjusting an article** on pages 68 and 69.
- Renamed Figure 103.
- Added **Replacing the blade guides** on page 83.
- Updated Table 18.