

HVSH-1580D-MOD 15kV Class

Splice for PILC-to-PILC or
PILC-to-Extruded Dielectric
(Poly/EPR) Power Cable

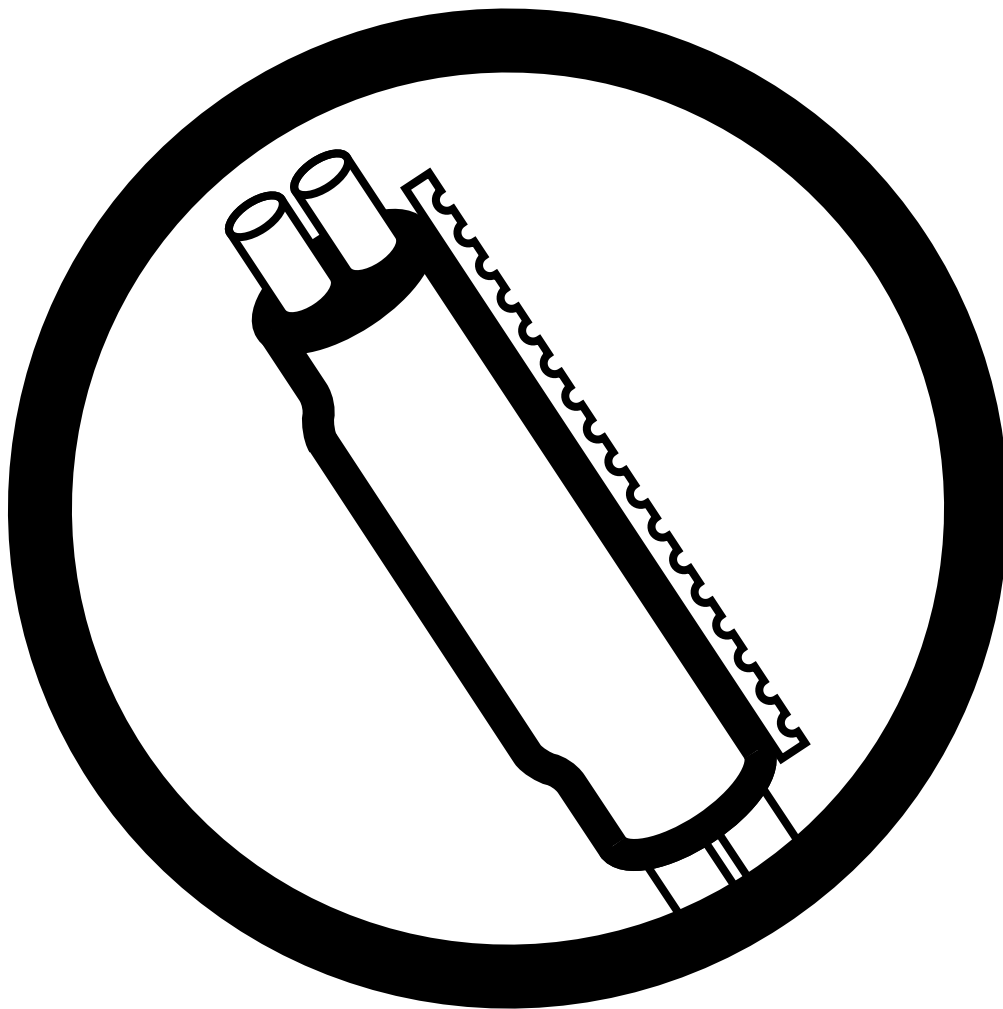

UniShield is a registered trademark of Cablec Corporation.

General Instructions

Suggested Installation Equipment (not supplied with kit)

- Cable preparation tools
- Raychem P63 cable preparation kit or cable manufacturer approved solvent
- Clean, lint-free cloths
- Non-conducting abrasive cloth, 120 grit or finer
- Electrician's tape
- Connector(s) and installation tools
- Raychem recommended torch

Recommended Raychem Torches

Install heat-shrinkable cable accessories with a "clean burning" torch, i.e., a propane torch that does not deposit conductive contaminants on the product.

Clean burning torches include the Raychem FH-2609, FH-2629 (uses refillable propane cylinders) and FH-2616A1 (uses disposable cylinder).

Safety Instructions

Warning: When installing electrical power system accessories, failure to follow applicable personal safety requirements and written installation instructions could result in fire or explosion and serious or fatal injuries.

To avoid risk of accidental fire or explosion when using gas torches, always check all connections for leaks before igniting the torch and follow the torch manufacturer's safety instructions.

To minimize any effect of fumes produced during installation, always provide good ventilation of confined work spaces.

As Raychem has no control over field conditions which influence product installation, it is understood that the user must take this into account and apply his own experience and expertise when installing product.

Adjusting the Torch

Adjust regulator and torch as required to provide an overall 12- inch bushy flame. The FH-2629 will be all blue, the other

torches will have a 3- to 4-inch yellow tip. Use the yellow tip for shrinking.

Regulator Pressure

FH-2616A1	Full pressure
FH-2609	5 psig
FH-2629	15 psig

Cleaning the Cable

Use an approved solvent, such as the one supplied in the P63 Cable Prep Kit, to clean the cable. Be sure to follow the manufacturer's instructions. Failure to follow these instructions could lead to product failure.

Some newer solvents do not evaporate quickly and need to be removed with a clean, lint-free cloth. Failure to do so could change the volume resistivity of the substrate or leave a residue on the surface.

Please follow the manufacturer's instructions carefully.

General Shrinking Instructions

- Apply outer 3- to 4-inch tip of the flame to heat-shrinkable material with a rapid brushing motion.
- Keep flame moving to avoid scorching.
- Unless otherwise instructed, start shrinking tube at center, working flame around all sides of the tube to apply uniform heat.

To determine if a tube has completely recovered, look for the following, especially on the back and underside of the tube:

1. Uniform wall thickness.
2. Conformance to substrate.
3. No flat spots or chill marks.
4. Visible sealant flow if the tube is coated.

Note: When installing multiple tubes, make sure that the surface of the last tube is still warm before positioning and shrinking the next tube. If installed tube has cooled, re-heat the entire surface.

Installation Instructions

HVSH-1580D-MOD KIT

This kit is intended to convert the standard HVSY-1580D series kits into HVSH-1580D kits for use on PILC-to-PILC or PILC-to extruded dielectric cables.

The short red shim tube and installation instruction included in the HVSY kit should be discarded.

1. Product selection.

Check kit selection with cable diameter dimensions in Table 2.

Note: Table is for 100% insulated cable. For 133% insulated cable, check actual cable dimensions.

2. Check ground braid.

Verify that ground braid(s) or bond wire have equivalent cross-section to cable metallic shield. Additional braid may be required for LC shield cables, or if external grounding or shield interrupting is required.

The Raychem HVS-EG kit supplies ground braid, spring clamp and suggested modifications to make an external ground or shield interrupt.

Table 2

Raychem Kit Required	Nominal Conductor Size		Insulation Diameter		Maximum Connector Length
	Main AWG/kcmil	Tap AWG/kcmil	Main Min-Max	Tap Min-Max	
HVSY-1582D HVSH-1582D-MOD	#2-4/0	#2-4/0	0.65-1.05" (17-27mm)	0.65-1.05" (17-27mm)	3.00" (75mm)
HVSY-1583D HVSH-1583D-MOD	250-750	#2-750*	0.85-1.45" (22-37mm)	0.65-1.45" (17-37mm)	3.50" (90mm)

*Check cable insulation diameter to ensure proper fit.

PILC Cable Preparation

Follow Steps 3-10 to prepare the PILC cable(s).

3. Prepare PILC cable(s).

Prepare the cable(s) as shown.

***Note:** If unjacketed, mark cable at 12" dimension.

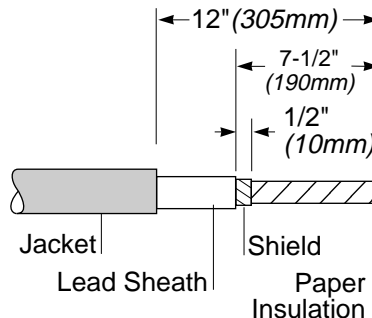

1430

4. Prepare lead sheath and paper insulation.

Remove lead oxide from the lead sheath and clean with an approved solvent.

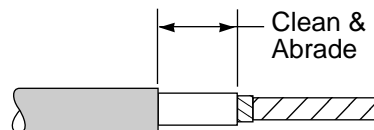

Remove conductive material from the paper insulation.

1431

5. Mark lead sheath.

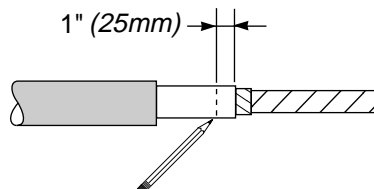

1432

6. Apply Stress Relief Material (SRM) at lead sheath cutback.

Remove backing from one side of a *long strip* of SRM. Roll the SRM and remaining backing strip into a convenient size.

Remove the remaining backing strip and tightly wrap SRM around the shield. Continue wrapping to the mark on the lead sheath, then back across the shield onto the paper insulation as shown.

Note: Apply a maximum thickness of 1/8" (3mm) of SRM over the lead sheath to prevent excessive diameter build-up. Save the remaining SRM.

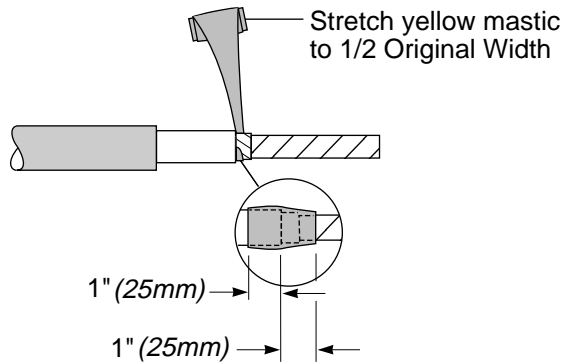

1433

7. Position Oil Barrier Tube (OBT); shrink in place.

Note: If using HVSH-1583D kit and tap cable is smaller than 250kcmil, install the smallest diameter OBT on the tap cable.

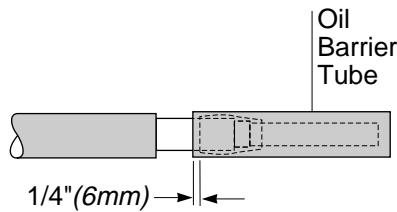

1434

Place the OBT over the cable as shown. Shrink in place starting at the SRM. Work around the tube with a smooth brushing motion.

To achieve a smooth wrinkle-free installation, use a reduced flame to install the thin-walled OBT.

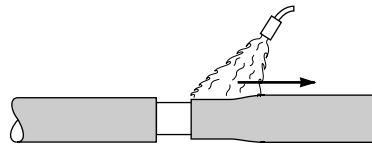

1435

8. Inspect OBT.

The OBT should have a smooth, wrinkle-free surface after shrinking. Reheat to smooth any wrinkled areas.

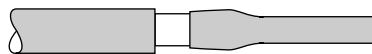

1435a

9. Position Black Stress Control Tube; shrink in place.

Note: If using HVSH-1583D kit and tap cable is smaller than 250 kcmil, install the smaller diameter stress control tube on the small tap cable.

Place a black stress control tube over the installed OBT at dimension "X" as shown in Table 3 at right.

Begin shrinking from "X" dimension toward the lead sheath end. Work the torch around all sides of the tube toward the other end of the tube.

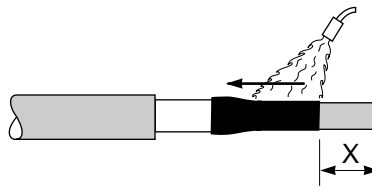

Table 3

Kit	X
HVSH-1582D-MOD	3-1/4" (83mm)
HVSH-1583D-MOD	3-3/4" (95mm)

1436

10. Cut back OBT/Insulation.

Remove OBT/Insulation to dimension "C" from Table 4 below.

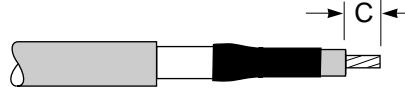

1437

11. Prepare remaining PILC cables.

Repeat Steps 3-10 to prepare remaining PILC cables.

12. Prepare Poly Cables

Find the cable type (Choice 1-3) and use the dimensions shown in Table 3 to prepare the cables.

Table 4 Kit	Jacket Cutback A	Semi-con Cutback B	Insulation Cutback C
HVSH-1582D-MOD	12.0" (305mm)	7.0" (180mm)	2.5" (65mm)
HVSH-1583D-MOD	12.0" (305mm)	7.0" (180mm)	3.0" (75mm)

CHOICE 1	CHOICE 2	CHOICE 3
<p>If Metallic Tape Shield or Lead Sheath Cable</p> <p>1300</p>	<p>If Drain Wire Shield Cable</p> <p>1301</p>	<p>If UniShield Cable</p> <p>1302</p>

13. Abrade insulation.

Abrade the insulation, as necessary to remove imbedded semi-con, and clean.

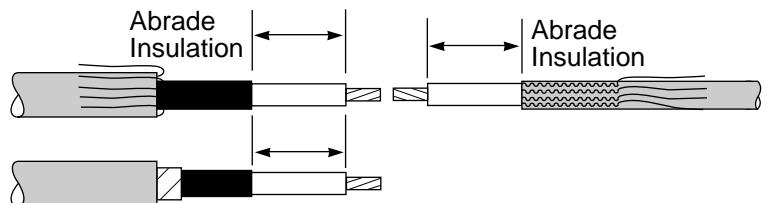

5147

14. Apply Stress Relief Material (SRM) at semi-con cutbacks.

Remove indicated backings from the short angle-cut piece of SRM. Place tip of SRM at semi-con cutback, stretch and tightly wrap to fill semi-con step. Overlap semi-con and insulation as shown. Taper SRM down to meet insulation. Repeat on other three cables.

Note: If using UniShield cable, apply SRM as shown to fill conductive jacket step.

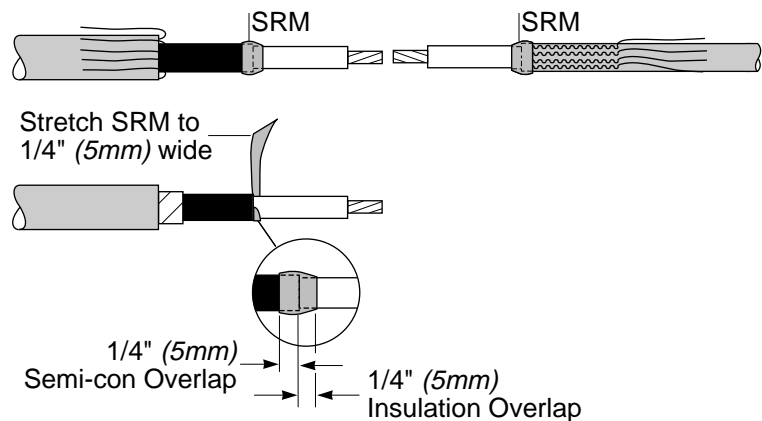

5148

15. Position Black Stress Control Tube; shrink in place.

Note: For HVSH-1583D with cable smaller than 250 kcmil.

Replace larger stress control tube with smaller stress control tube for cables smaller than 250 kcmil.

Place a black stress control tube over each cable 1/4" (5mm) from the insulation cutback as shown.

Begin shrinking from the exposed conductor. Work the torch around all sides toward the other end of the tube.

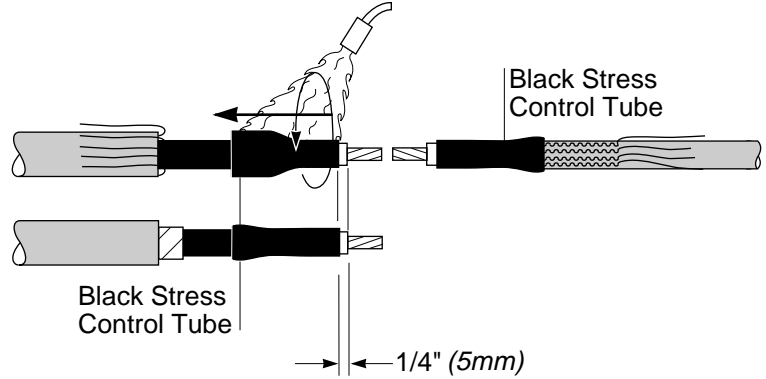

5149

16. Clean cable jacket.

Clean cable jackets as shown.

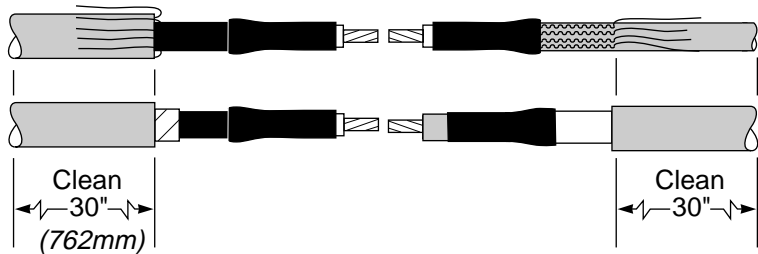

5150

17. Position nested tubes; install connector.

Note: Nested tubes must be kept clean during the installation procedure.

Nest the red insulating tube within the black/red dual layer tube and place over one side of splice. **For the HVSH-1583D, there will be 2 red insulating tubes.** Join conductors using a soldered half-duplex connector.

Note: Protect installed tubes from burning & solder splatter by wrapping them with cloth tape (or equivalent). Remove protection after connection is complete.

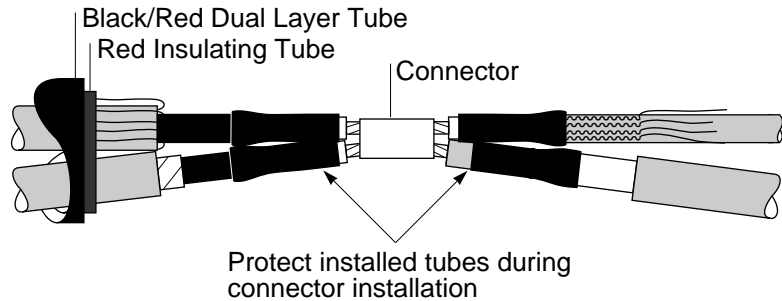

5151

18. Apply SRM.

Thoroughly clean all splice surfaces. Cut short pieces of SRM [about 1-1/2" (35mm) long]. Remove backing strips and roll the SRM up tightly. Pack the pieces between the two conductors making sure that **ALL AIR GAPS BETWEEN THE ENDS OF THE INSULATION AND CONNECTOR ARE COMPLETELY FILLED WITH SRM.** Repeat on other side of splice.

Remove indicated backing from one side of a strip of SRM. Roll the SRM and remaining backing strip into a convenient size. Removing the remaining backing strip, stretch and tightly wrap the SRM around the connector and exposed conductor.

ENSURE THAT THE COMPLETE CIRCUMFERENCE OF ANY EXPOSED OIL BARRIER TUBE IS COMPLETELY COVERED BY THE SRM TO CREATE AN EFFECTIVE OIL BLOCK.

Continue to wrap SRM onto the insulation and installed tubes, building up a smooth profile as shown. The SRM should extend onto the black tubings by 1/4" (5mm).

Be sure to fill the gaps and low spots around the connector.

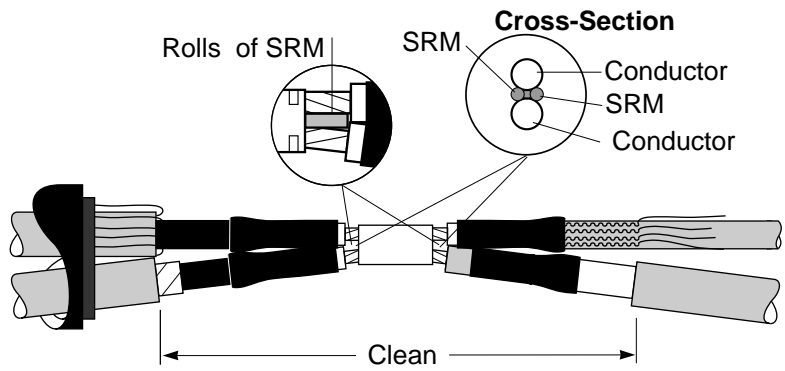

5152

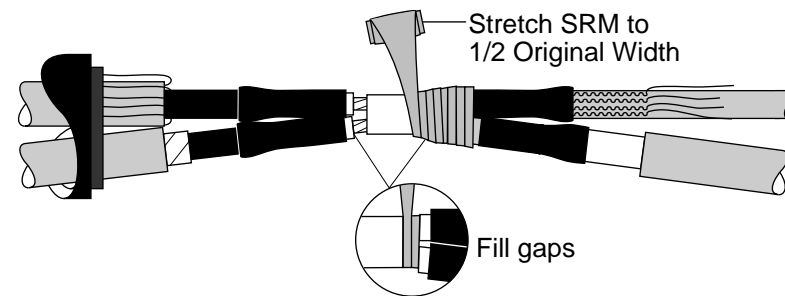

5153

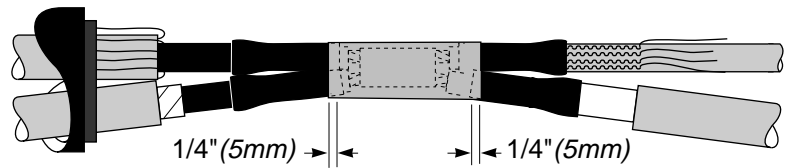

5154

19. Position red Insulating Crotch Profiles (ICP).

Remove the backing paper from the ICP. Also, remove the release paper from the red mastic on the ICP

Note: To ease positioning of the ICP, apply a thin layer of silicon grease to the leading edge of the ICP only. DO NOT OVERAPPLY!

Position the first ICP between the two cables (red mastic inward) on the side of the joint without the nested tubes. Push the ICP up against the SRM. Move the nested tubes to the other side of the joint and position the second ICP in a similar manner to the first (red mastic inward). Train the cables to lay parallel to each other and flat against the ICPs.

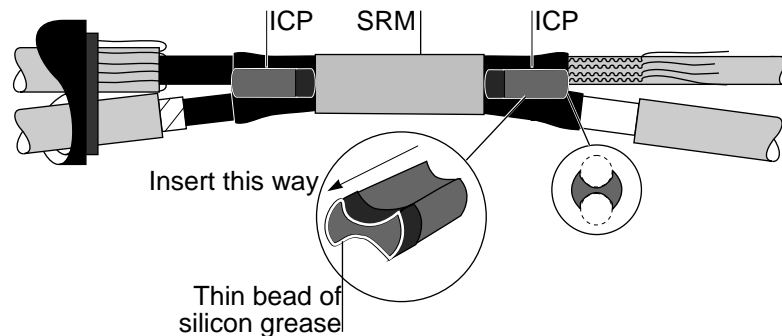

5155

20. Bind cables. Position red insulating tube; shrink in place.

Note: For the HVSH-1583D, the smaller red insulating tube is shrunk first.

Bind the cables together with a cable tie.

Center red insulating tube between jacket cutbacks. Begin shrinking at center of tube (1), working torch with a smooth brushing motion around all sides of the tube to avoid scorching.

When the center has shrunk, work the torch as before toward one end of the tube. (2) Apply enough heat to shrink the tube and soften the ICP.

Note: The ICP is designed to melt and fill the gaps between the main and tap cables. Sufficient heat has been applied when the ICP shoulders have rounded off and started to melt. (Check for melting by looking inside the ends of the red tube.)

When one end has shrunk and the ICP has started to melt, work the torch as before toward the opposite end (3), making sure that the ICP has started to melt on that side.

Apply enough heat to shrink the tube and smooth the underlying profiles of the ICPs and SRM over the connector. After shrinking, tighten cable ties as necessary.

20a For HVSH-1583D only!

Center the second red insulating tube and shrink as described in step 20.

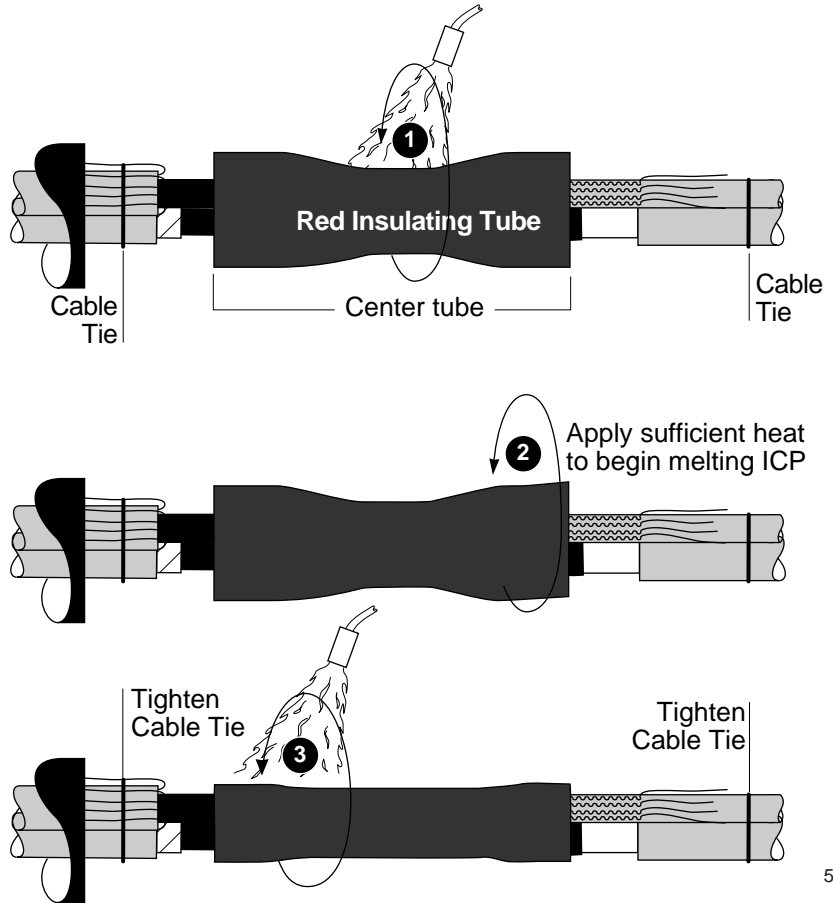

5162

21. Position black/red dual layer tube; shrink in place.

While red insulating tube is still hot, center black/red dual layer tube over the red tube and shrink in place using method described in Step 20.

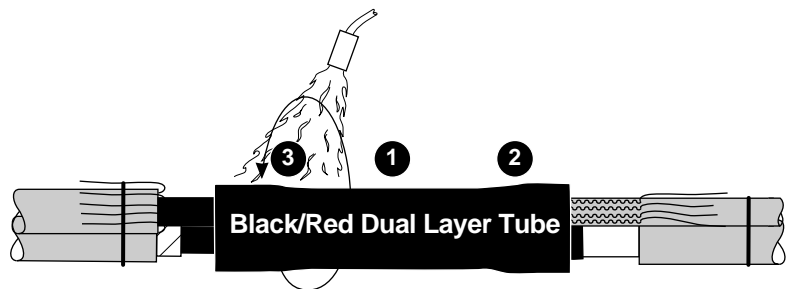

5163

22. Apply red sealant to both sides of joint.

Remove both backing strips from a length of red sealant and fill in gaps between the two cables with short pieces of rolled up sealant. Push the sealant into all spaces as shown, to form a good base for moisture seal. Repeat on other side of splice.

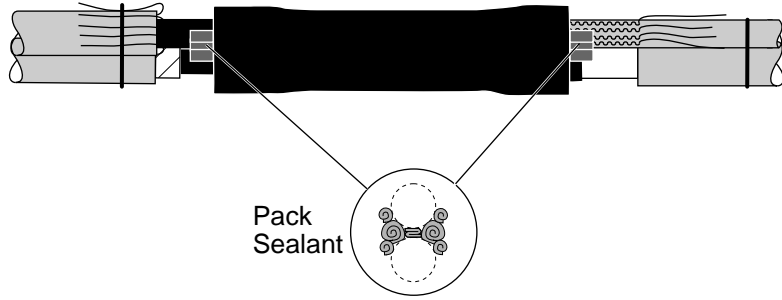

5164

Wrap red sealant around both cables as shown, covering packed sealant. Continue to wrap the sealant 1/2" (10mm) onto the black/red dual layer tube. Push the sealant into all gaps. Repeat on other side of splice.

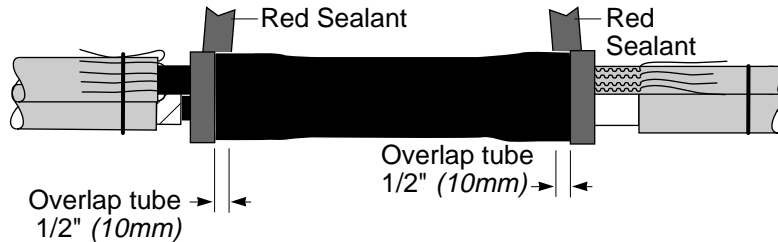

5165

Remove cable ties.

23. Install ground braid.

Find the appropriate cable combination (Choice 1-2) and follow the directions given.

CHOICE 1	CHOICE 2
----------	----------

If one or both of the cables on side 1 are Metallic Tape Shield cable, Go to Step 24.

If neither of the cables on side 1 are Metallic Tape Shield cable, Go to Step 26, Page 10.

CHOICE 1, SIDE 1

If one or both of the cables on side 1 are Metallic Tape Shield .

24. Connect ground braid to metallic tape shield cable.

Note: for HVSH-1583D kits.

If cable is smaller than 250kcmil, use the smallest spring clamp to install the ground braid. If the cable is 250 kcmil or greater, use the larger clamp.

Lay ground braid across the shield with approximately 4" (102mm) extending toward the center of the splice as shown. Attach the braid to the shield by placing two wraps of the spring clamp over the braid.

Fold the long part of the braid back over the spring clamp toward the center of the splice. Continue to wrap the remaining clamp over the braid. Tighten clamp by twisting it in the direction it is wrapped and secure with copper foil tape provided.

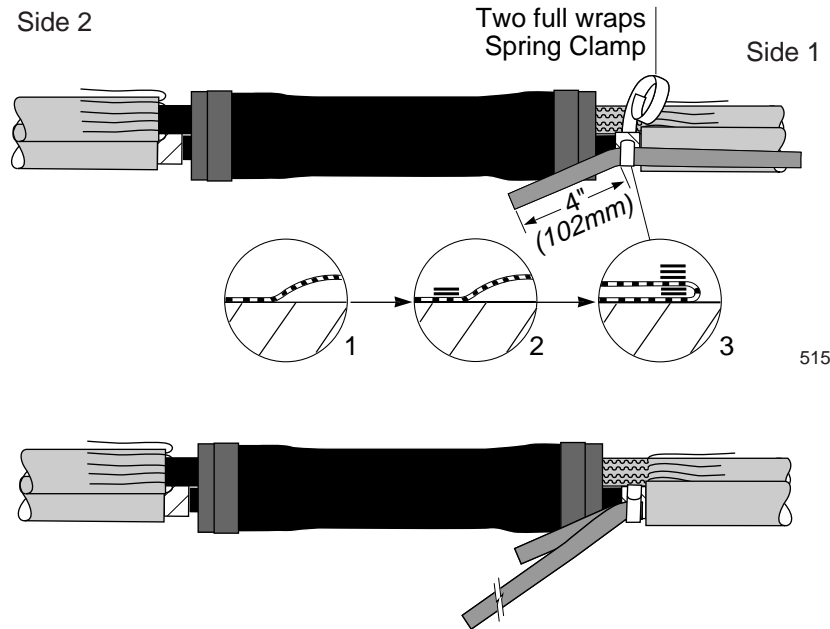

5156

5157

25. Attach braid to tap cable on side 1

Find the appropriate cable configuration (25a-25c) and follow the instructions given.

25a. If Metallic Tape Shield cable.

Metallic Tape Shield

Lay the shorter length of braid across the tape shield. Attach braid to the shield by placing two wraps of the spring clamp over the braid.

Fold braid back over spring clamp toward center of the splice. Complete clamp installation as shown in Step 13. Trim excess braid.

Two full wraps
Spring Clamp

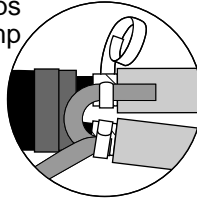

Trim excess
braid

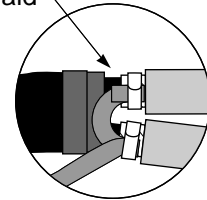

5158

5159

25b. If Drain Wire or UniShield cable.

Drain Wire or UniShield

Twist the drain wires to form a pigtail. Connect pigtail to shorter length of braid using a compression connector or other approved method. Trim excess braid and drain wires.

Install compression
connector

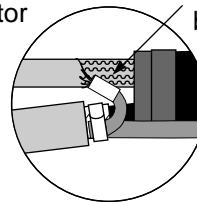

Trim excess
braid & wires

5160

Go to Step 27, Page 11.

16c. If Lead Sheath cable.

Lead Sheath

Solder the shorter length of braid to the lead sheath as shown. Trim excess braid.

Solder braid to
lead sheath

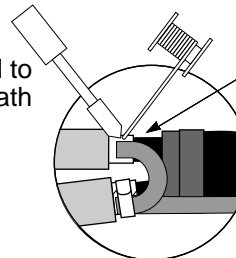

Trim excess
braid

5161

Go to Step 27, Page 11.

CHOICE 2, SIDE 1

If neither of the cables on side 1 are Metallic Tape Shield.

26. Find the appropriate cable configuration (26a-26c) and follow the directions given.

26a. If both cables are Wire Shield or UniShield.

Twist the drain wires to form a pigtail. Connect pigtail to the ground braid using a compression connector or other approved method. Trim excess braid and drain wires.

Install compression
connector

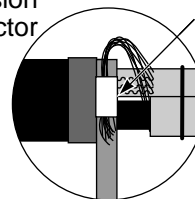

Trim excess
braid & wires

5170

Go to Step 27, Page 11.

26b. If one cable is Lead Sheath and other is Wire or UniShield.

Twist the drain wires to form a pigtail. Connect pigtail to the ground braid using a compression connector or other approved method.

Lay the ground braid across the lead sheath of the other cable and solder in place. Trim excess braid and drain wires.

Install compression connector

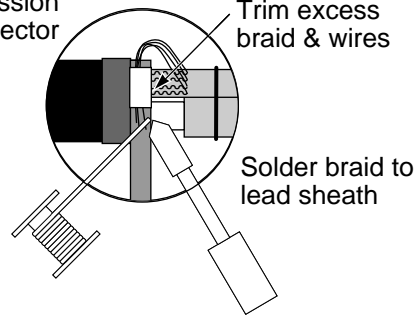

5171

Go to Step 27.

26c. If both cables are Lead Sheath.

Lay one end of ground braid across the lead sheath of both cables. Solder in place.

Continue to Step 27.

Solder Braid to Lead Sheaths

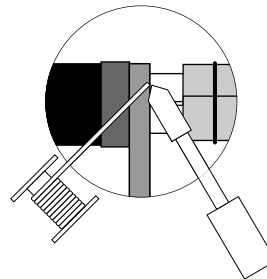

5172

27. Install ground braid to side 2.

Find the appropriate cable configuration (Choice 1-2) and follow the instructions given.

CHOICE 1

If one or both of the cables on side 2 are Metallic Tape Shield cable, Go to Step 28.

CHOICE 2

If neither of the cables on side 2 are Metallic Tape Shield cable, Go to Step 30, Page 12.

CHOICE 1, SIDE 2

If one or both of the cables on side 2 are Metallic Tape Shield .

28. Connect ground braid to metallic tape shield cable.

Note: For HVSH-1583D kits.

If cable is smaller than 250kcmil, use the smallest spring clamp to install the ground braid. If the cable is 250 kcmil or greater, use the larger clamp.

Lay ground braid across the shield with approximately 4" (102mm) extending away from the center of the splice as shown. Attach the braid to the shield by placing two wraps of the spring clamp over the braid.

Fold the remainder of the braid back over the spring clamp toward the center of the splice. Continue to wrap the remaining clamp over the braid. Tighten clamp by twisting it in the direction it is wrapped and secure with copper foil tape provided.

Side 2

Two full wraps Spring Clamp

Side 1

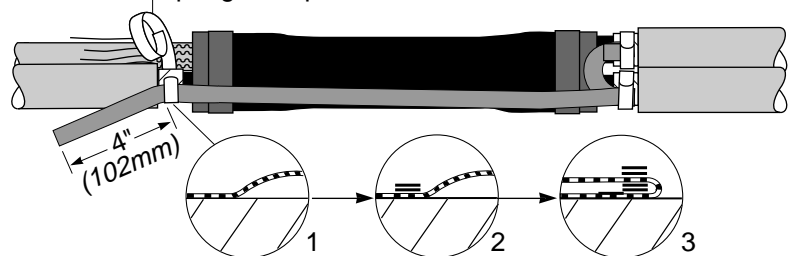

5175



5176

29. Attach braid to tap cable on side 2.

Find the appropriate cable configuration (29a-29c) and follow the instructions given.

29a. If Metallic Tape Shield cable.

Lay the short length of braid across the tape shield. Attach braid to the shield by placing two wraps of the spring clamp over the braid.

Fold braid back over spring clamp toward center of the splice. Complete clamp installation as shown in Step 19. Trim excess braid.

Go to Step 31, Page 13.

Metallic Tape Shield

Two full wraps
Spring Clamp

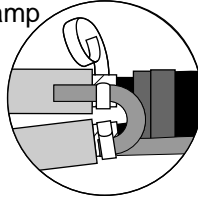

5177

Trim excess
braid

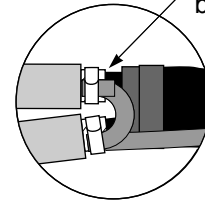

5178

29b. If Drain Wire or UniShield cable.

Twist the drain wires to form a pigtail. Connect pigtail to short length of braid using a compression connector or other approved method. Trim excess braid and drain wires.

Go to Step 31, Page 13.

Drain Wire or UniShield

Install compression
connector

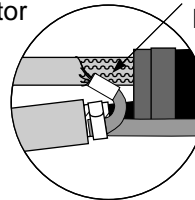

Trim excess
braid & wires

5160

29c. If Lead Sheath cable.

Solder the short length of braid to the lead sheath as shown. Trim excess braid.

Go to Step 31, Page 13.

Lead Sheath

Solder braid to
lead sheath

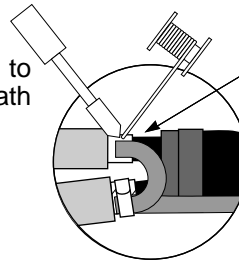

Trim excess
braid

5161

CHOICE 2, SIDE 2

If neither of the cables on side 2 are Metallic Tape Shield.

30. Find the appropriate cable configuration (30a-30c) and follow the directions given.

30a. If both cables are Wire Shield or UniShield.

Twist the drain wires to form a pigtail. Connect pigtail to the ground braid using a compression connector or other approved method. Trim excess braid and drain wires.

Go to Step 31, Page 13.

Install compression
connector

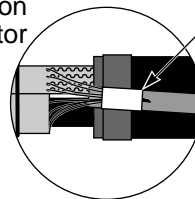

Trim excess
braid & wires

5173

30b. If one cable is Lead Sheath and other is Wire or UniShield.

Twist the drain wires to form a pigtail. Connect pigtail to the ground braid using a compression connector or other approved method.

Lay the ground braid across the lead sheath of the other cable and solder in place. Trim excess braid and drain wires.

Go to Step 31.

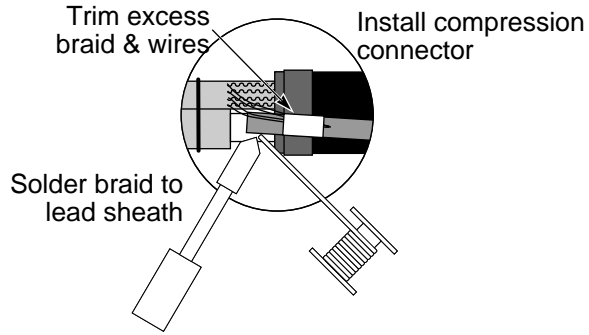

5174

30c. If both cables are Lead Sheath.

Lay ground braid across the lead sheath of both cables. Solder in place. Trim excess braid.

Continue to Step 31.

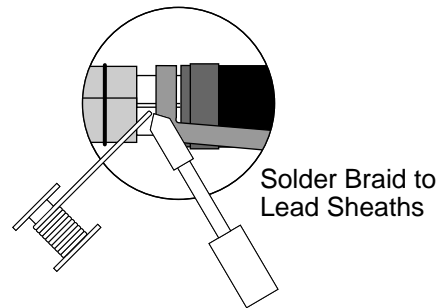

5181

31. Apply shielding mesh.

Begin wrapping the shielding mesh on the one side of the splice. Half-lap the mesh over the entire length of the outer tube. Tie off with a half hitch.

Half-lapped Shielding Mesh

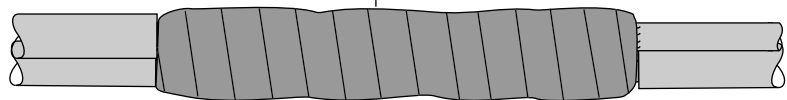

5166

32. Clean and abrade cable jackets.

Solvent clean and abrade all cable jackets for approximately 6" (152mm) from mesh as shown.

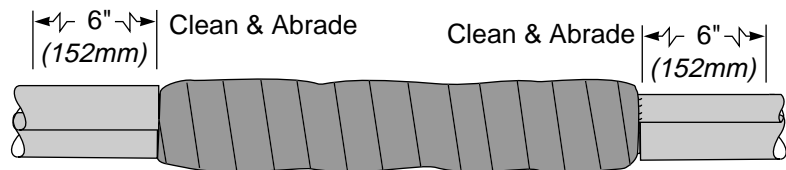

5167

33. Position wraparound sleeve.

Remove or tape over all sharp points to prevent puncture of wraparound sleeve. Remove backing from wraparound sealing sleeve and center sleeve over splice. Slide metal channel onto the butted rails.

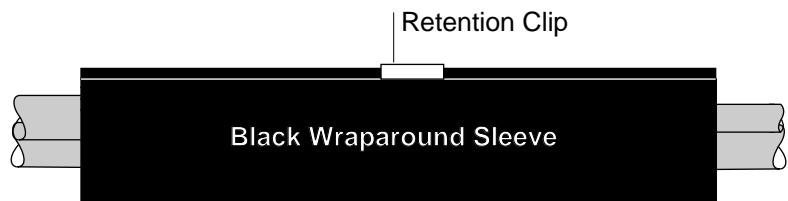

5168

34. Install channels; install breakout clips.

Rotate sleeve so that channel is positioned as shown.

Slide the channels toward the center from each end of the sleeve and over the retention clip. A minimum of 1/2 inch (10mm) of channel should be extended beyond the edges of the sleeve.

On the both sides of the splice, insert the break-out clip between the two cables, clipping together the walls of the wraparound sleeve.

Using cable ties provided, bind the cables together approximately 3" (76mm) from ends of the sleeve.

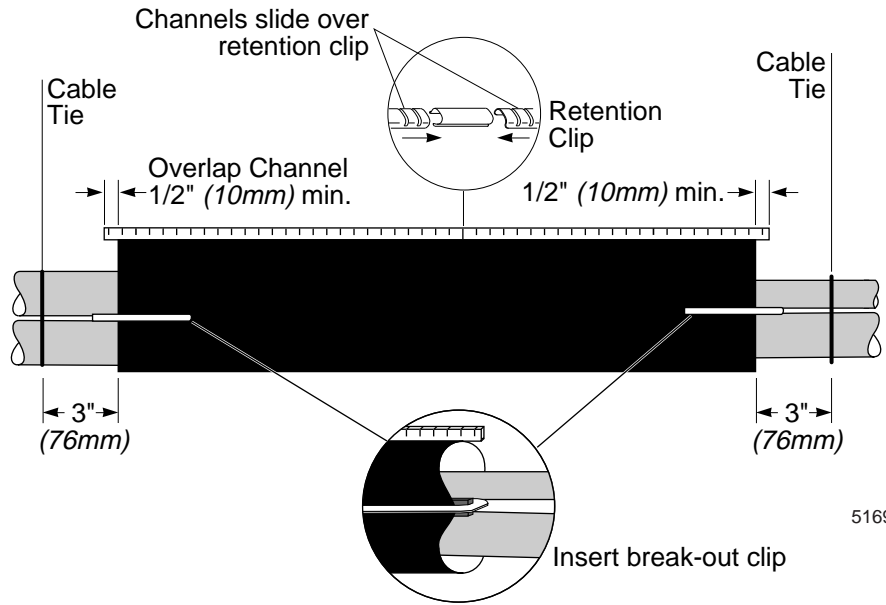

5169

35. Check flap for pinching.

As shown in illustration A, make sure flap is not pinched between the rails. Push the sleeve up from the bottom and down from the top while sliding on channel as shown in illustration B. This causes rails to flatten together and prevents channels from binding installation.

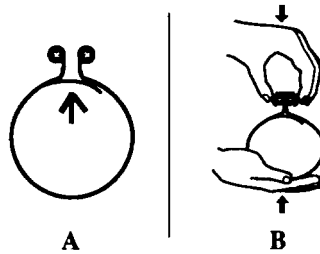

36. Shrink the wraparound sleeve.

Preheat evenly along both sides of the rail/channel area until this area begins to shrink. To achieve uniform heating, move the flame back and forth from one side of the channel to the other as shown in illustration "A" while moving flame along the entire length of the channel as shown in illustration "B" until the sleeve starts to shrink. This technique will assure a properly preheated rail and channel area.

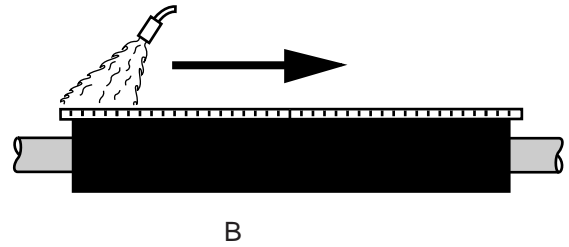
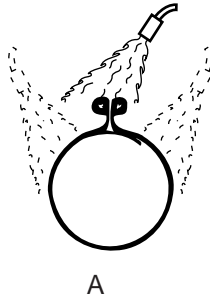

Begin shrinking at the center of the sleeve and work toward each end. Apply heat until the sleeve is fully shrunk and the heat-sensitive green paint is completely converted to black. Continue heating the rail/channel area for another 5 seconds per foot. A white line should be visible in the channel gaps indicating sufficient heating.

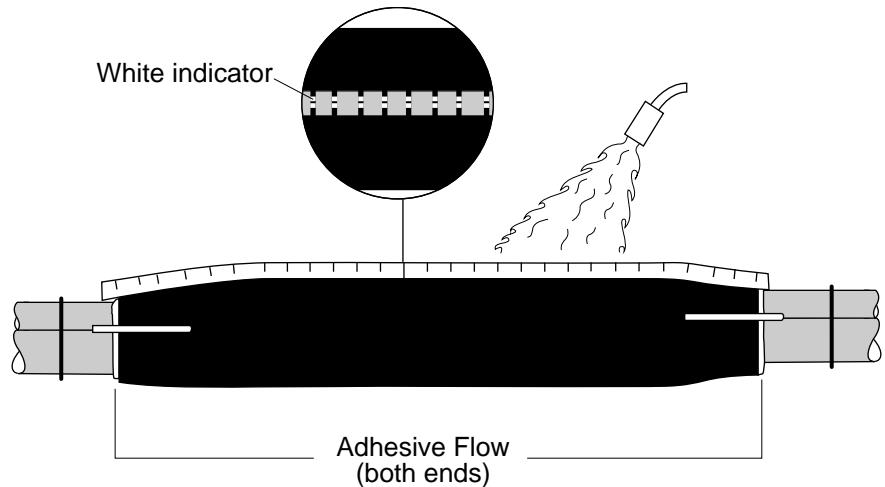

Note: Green heat-sensitive paint will turn black as sleeve shrinks in place.

This completes the splice.

Note: Allow to cool before moving or placing in service.

5182