

# TFT-150R-G

5-15kV Cold Applied Indoor (5 - 8kV Indoor and Outdoor)  
Termination for Copper Tape, Wire Shield, Lead Sheath, and  
UniShield Cable

## ENERGY DIVISION

### Suggested Installation Equipment (not supplied with kit)

- Cable preparation tools
- Tyco Electronics P63 cable preparation kit or cable manufacturer approved solvent
- Clean, lint-free cloths
- Non-conducting abrasive cloth, 120 grit or finer
- Electrician's tape
- Connector(s) and installation tools

### Safety Instructions

**Warning:** When installing electrical power system accessories, failure to follow applicable personal safety requirements and written installation instructions could result in fire or explosion and serious or fatal injuries.

*As Tyco Electronics has no control over field conditions which influence product installation, it is understood that the user must take this into account and apply his own experience and expertise when installing product.*

**Note:** There are separate instructions for each cable type addressed in this instruction. Turn to the page denoted at the right for your cable type.

### Tape Shield Cable (page 2)



1

### Wire Shield Cable (page 7)



2

### UniShield Cable (page 11)



3

### Lead Sheath Cable (page 15)



4

### Cleaning the Cable

Use an approved solvent, such as the one supplied in the P63 Cable Prep Kit, to clean the cable. Be sure to follow the manufacturer's instructions. Failure to follow these instructions could lead to product failure.

Please follow the manufacturer's instructions carefully.

Some newer solvents do not evaporate quickly and need to be removed with a clean, lint-free cloth. Failure to do so could change the electrical characteristics of the cable or leave a residue on the surface.

### Kit Contents

- 1 Installation Instruction
- 1 Silicone housing on holdout
- 1 Stress control patch
- 1 Roll spring
- 1 Solder blocked ground braid
- 2 Adhesive backed copper tape strips
- 1 Cloth tape
- Sealant tape strips

# Installation Instructions

## 1. Select product

Check kit selection with cable diameter dimensions in table 1 below.

Table 1

Kit	Nominal Conductor Size			Min/max Insulation ODs*
	5kV (in/outdoor)	8kV (in/outdoor)	15kV (indoor only)	
TFT-150R-G	#2-3/0 AWG	#2-3/0 AWG	#2-3/0 AWG	0.53-0.80" (13-20mm)
TFT-151R-G	2/0-500 kcmil	1/0-350 kcmil	#2-250 kcmil	0.64-1.09" (16-28mm)
TFT-152R-G	350-1000 kcmil	250-750 kcmil	4/0-500 kcmil	0.85-1.45" (22-37mm)
TFT-153R-G	750 - 1250 kcmil	500-1000 kcmil	500-750 kcmil	1.06-1.70" (27-43mm)

Note: 15kV Insulation ODs and nominal conductor sizes are based on 100 and 133% compact and concentric stranded cable dimensions. 5-8kV ODs are based on 100% and 133% compact stranded cable dimensions.

## Tape Shield Cables

### 2. Prepare cables

Determine insulation cutback length Z.



Figure 1: Insulation Cutback (Z)

Note: If no lug is used, Z = 2" (50mm)

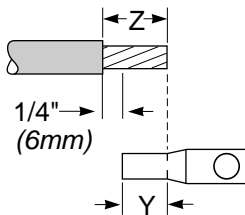

$$\text{"Z" Insulation Cutback} = \text{"Y" Length of Lug Barrel} + \frac{1}{4} \text{ (6mm)}$$

481

Refer to Figure 1 and adjacent drawing to prepare the cable as shown.

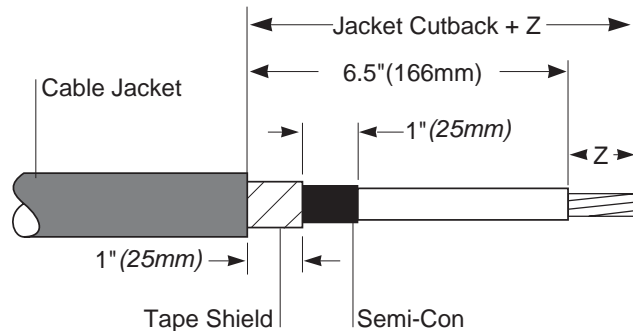

512

Remove the backing from a piece of copper foil provided and tape over the end of the shield as shown.

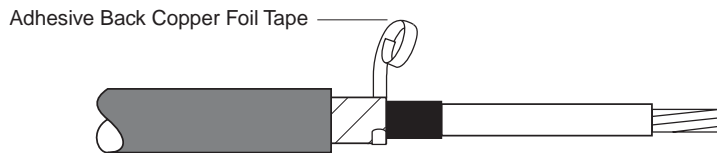

512b

### 3. Install ground braid

Flare the moisture blocked end of the ground braid and place it onto the tape shield butted up to the cable jacket. Attach the braid to the shield by placing two wraps of the spring clamp over the braid 1/4" from the jacket cutback. Fold the braid back over the spring clamp wraps. Continue to wrap the remaining clamp over the braid. Tighten clamp by twisting it in the direction it is wrapped.

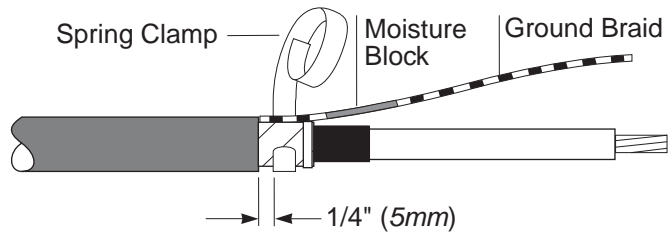

516



516a

Apply a small piece of copper adhesive tape foil on top of the spring clamp as shown.

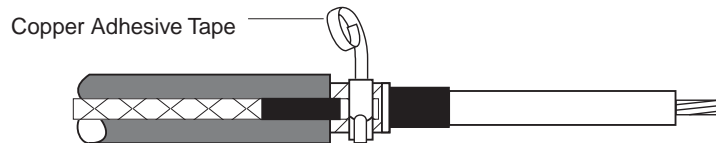

**Note:** Wrap the copper adhesive tape foil in the same direction as the spring clamp to tighten the wrap.

516b

### 4. Make Lug Connection

Crimp the connector using proper die and tool. Clean lug barrel of inhibitor and dirt and file off any sharp edges.

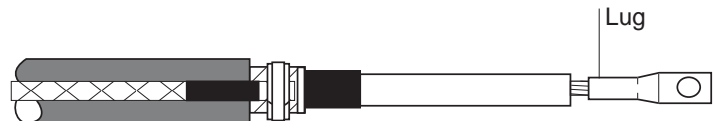

518

### 5. Abrade (sand) and clean insulation

Abrade and clean the surface of the primary insulation using the solvent supplied with the termination or any other approved solvent. Be sure to remove any conductive particles or contamination.

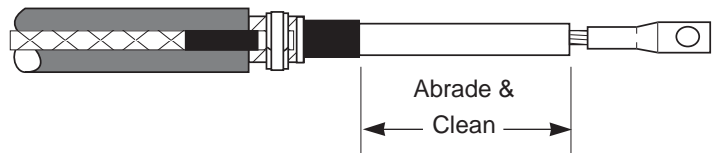

518a

**Note:** Use aluminum oxide abrasive strip only.

## 6. Install sealant

Start wrapping sealant at end of lug barrel. Continue wrapping (no "half laps") until sealant is same thickness as insulation (at least two wraps).

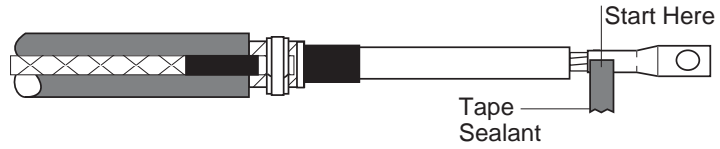

500

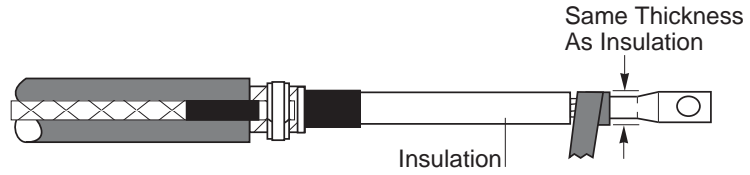

501

Continue wrapping on to the cable insulation for 1/2". Snap off any additional mastic.

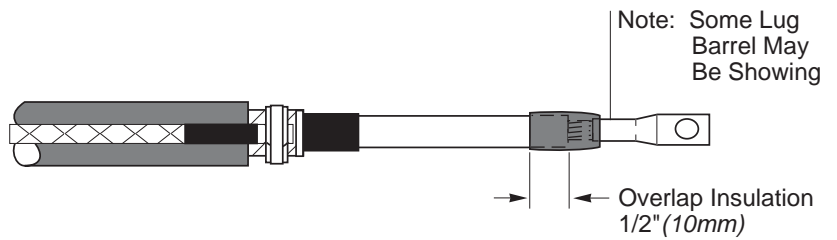

518c

Solvent clean and abrade (sand) jacket. Using light tension, wrap one layer of sealant onto the cable jacket, even with the jacket cutback as shown.

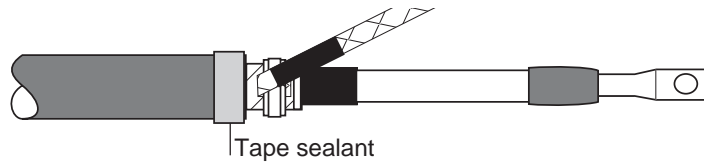

515

Press the solder-blocked portion of the braid into the sealant. Wrap an additional layer of sealant over the braid solder block, sandwiching the solder-block between layers of sealant.

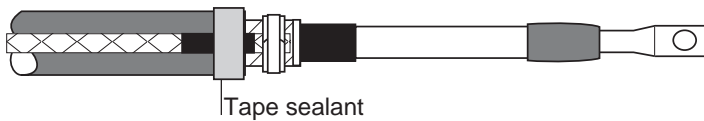

515a

## 7. Apply Stress Patch

**Note:** The stress patch easily sticks to itself and loose particles.

**Note:** The patch may be rectangular. Follow the direction of the arrow on the backing paper of the stress patch. Longer dimension goes around the cable.

Remove backing paper from the patch. Using light tension and overlapping the semi-con by 1" (25mm), wrap the entire patch around the semi-con as shown. Avoid wrinkles and creases.

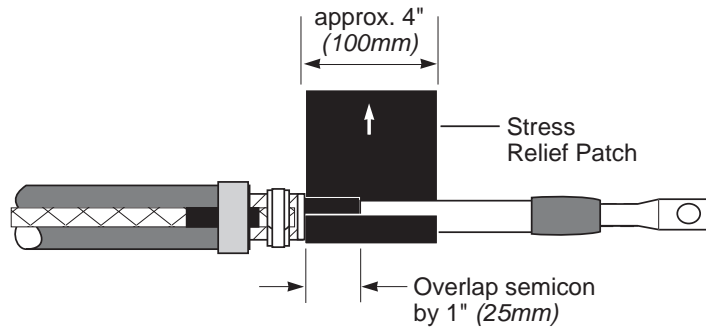

519

## 8. Tape over sharp edges

Using cloth tape provided, tape over all sharp edges of the ground clamp assembly.

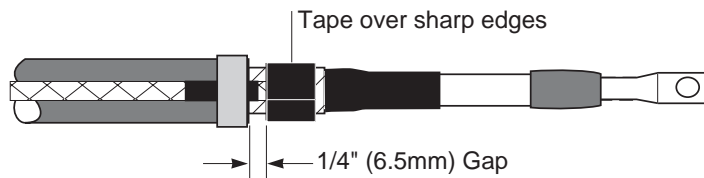

519a

## 9. Loosening Termination

***This operation is vital to the simple installation of the product.***

Hold the termination in one hand and the holdout in the other. Gripping firmly, twist the termination and holdout in opposite directions. Repeat twisting the termination and holdout, moving the hand in short increments up the termination until the entire termination is felt to move on the holdout. Slide the termination until it lines up with the end of the holdout tube as shown.

**Note:** Take care not to slide the termination off the end of the holdout. Stop the termination about 1/4" from the end of the holdout.

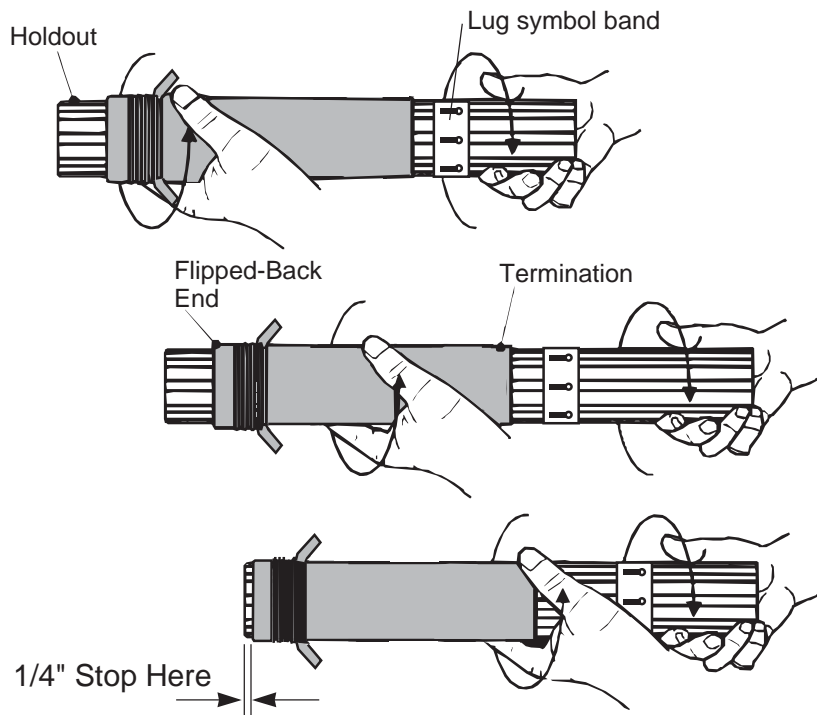

523ca

## 10. Installing termination

Position the holdout over the cable until it meets the jacket cutback. Twist the termination and slowly push it to the end of the holdout.

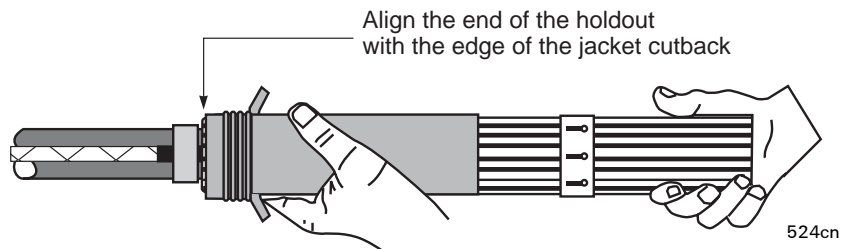

Slide the termination off the holdout with a twisting motion holding the termination that is on the holdout in one hand and pulling the holdout with the other.

Twist clockwise and counterclockwise while pulling out

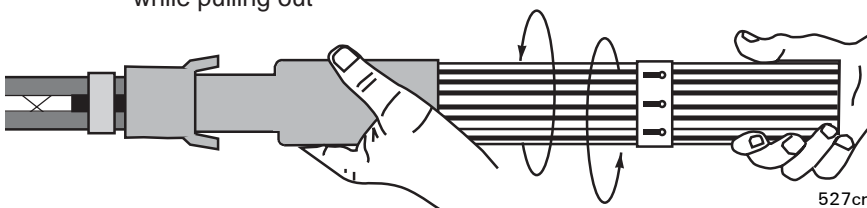

**Note: Do NOT stretch the termination.**

Do NOT hold the termination that is partially installed and attempt to pull the remaining termination off the holdout, as this will stretch the termination and generate an improperly installed termination if not repositioned.

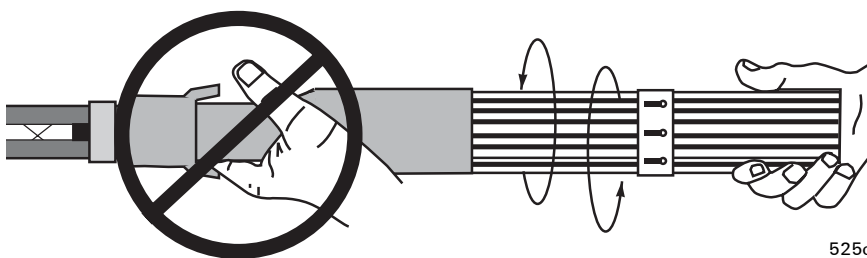

Using the pull tabs, pull the flip-back portion away from the main termination, at the same time working the first two fingers of each hand between the flip-back and main termination. Pull the stretched out flip-back over the cable jacket and sealant.

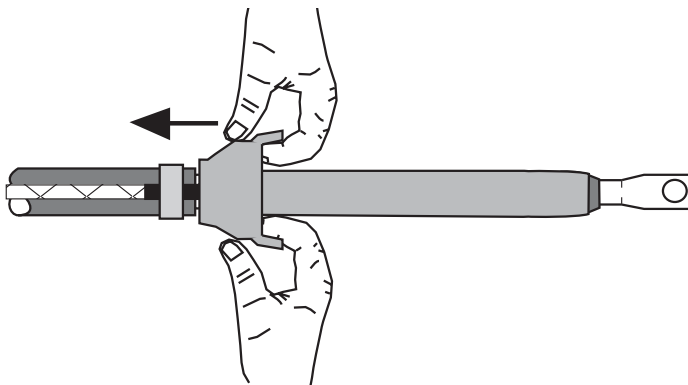

If the termination is not correctly positioned after installation, it is possible to gently slide it into place so that the final assembly is positioned as shown in the drawing in step 11.

## 11. Clean termination

534lc

Wipe over the surface of the termination to remove any dirt or grease.

The finished length of the termination should be approximately 10.0" (255mm) as shown.

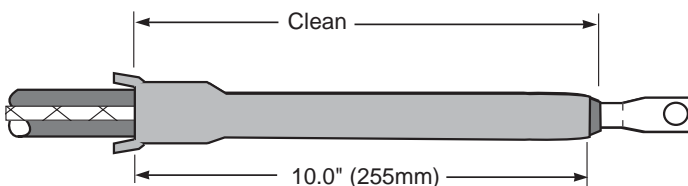

**This completes the installation.**



# Wire Shield Cables

## 1. Prepare cables

Determine insulation cutback: length Z.



Figure 1: Insulation Cutback (Z)

Note: If no lug is used, Z = 2" (50mm)

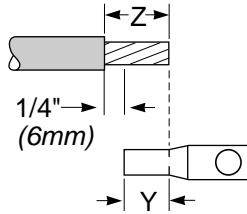

$$\text{"Z" Insulation Cutback} = \text{"Y" Length of Lug Barrel} + \frac{1}{4} \text{ (6mm)}$$

481

Refer to Figure 1 and adjacent drawing to prepare the cable as shown. Pull back drain wires as shown. Do not pigtail wires at this time.

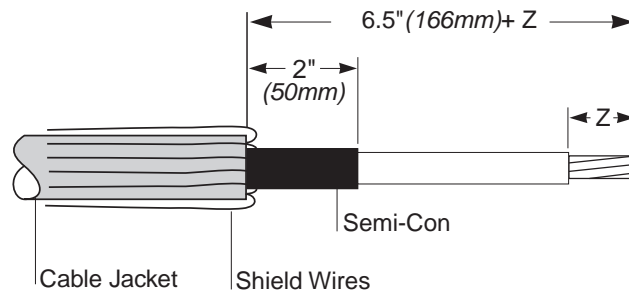

513

## 2. Make Lug Connection

Crimp the connector using proper die and tool. Clean lug barrel of inhibitor and dirt and file off any sharp edges.



518k

## 3. Abrade (sand) and clean insulation

Abrade and clean the surface of the primary insulation using the solvent supplied with the termination or any other approved solvent. Be sure to remove any conductive particles or contamination.



518l

Note: Use aluminum oxide abrasive strip only.

**4. Install sealant**

Start wrapping sealant at end of lug barrel. Continue wrapping (no "half laps") until sealant is same thickness as insulation (at least two wraps).

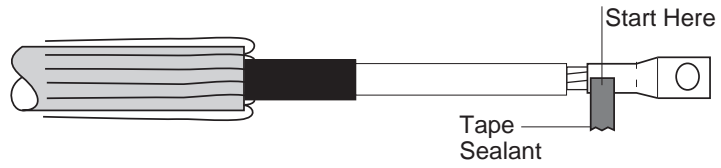

500d

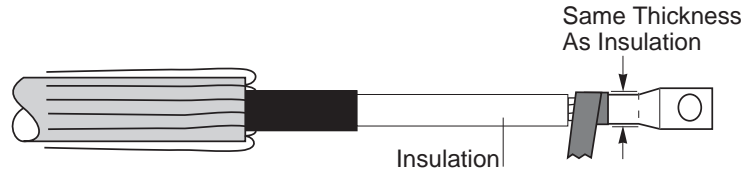

501d

Continue wrapping on to the cable insulation for 1/2". Snap off any additional mastic.

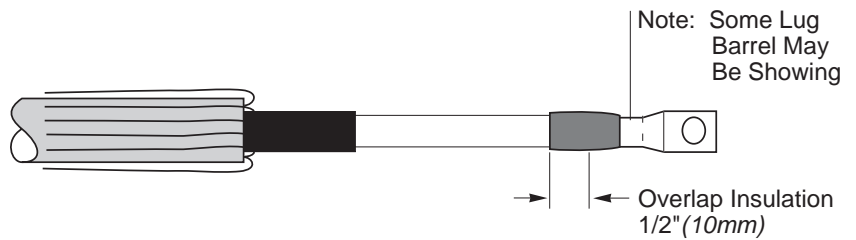

518m

**5. Apply tape sealant**

Lift the drain wires away from the cable jacket. Solvent clean and abrade jacket. Using light tension, wrap one layer of sealant onto the cable jacket as shown.

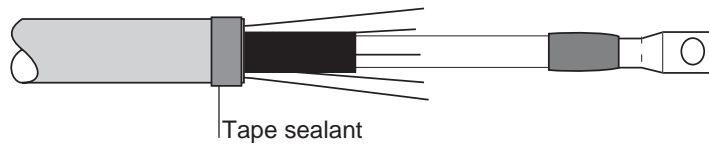

521b

Lay the drain wires evenly back over the jacket and press them into the sealant.

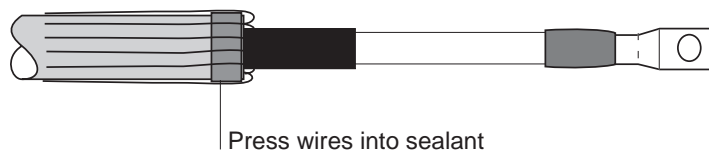

533b

Wrap an additional layer of sealant over the drain wires and previously applied sealant.



533c



## 6. Apply Stress Patch

**Note:** The stress patch easily sticks to itself and loose particles.

**Note:** The patch may be rectangular. Follow the direction of the arrow on the backing paper of the stress patch. Longer dimension goes around the cable.

Remove backing paper from the patch. Using light tension and overlapping the semi-con by 1" (25mm), wrap the entire patch around the semi-con as shown. Avoid wrinkles and creases.

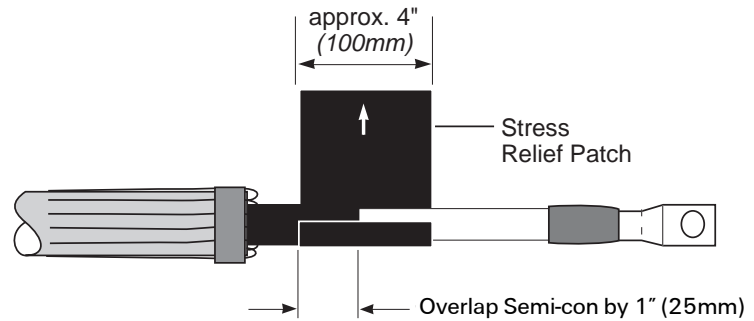

519f

## 7. Loosening Termination

***This operation is vital to the simple installation of the product.***

Hold the termination in one hand and the holdout in the other. Gripping firmly, twist the termination and holdout in opposite directions. Repeat twisting the termination and holdout, moving the hand in short increments up the termination until the entire termination is felt to move on the holdout. Slide the termination until it lines up with the end of the holdout tube as shown.

**Note:** Take care not to slide the termination off the end of the holdout. Stop the termination about 1/4" from the end of the holdout.

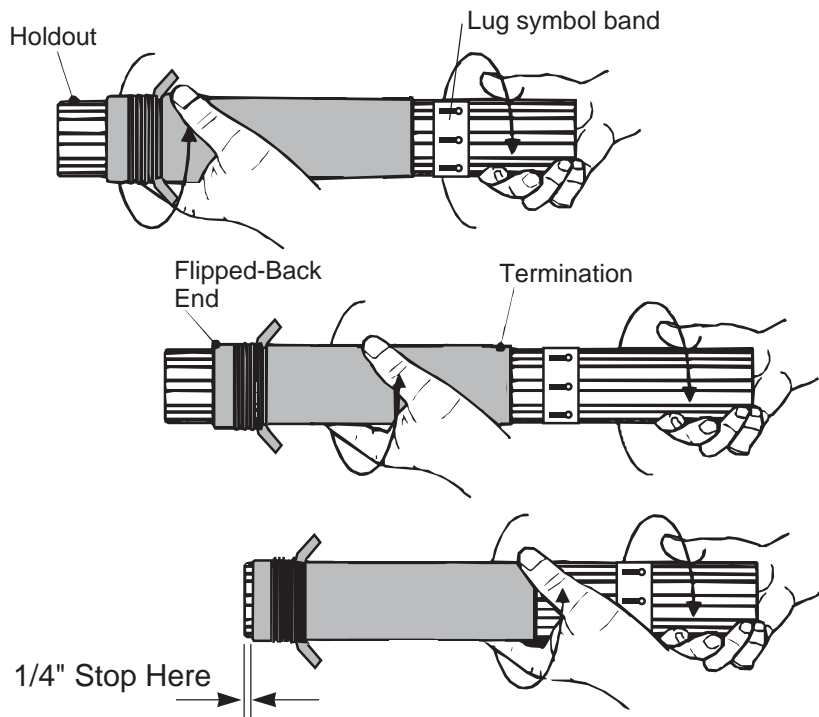

523ca

## 8. Installing termination

Position the holdout over the cable until it meets the jacket cutback. Twist the termination and slowly push it to the end of the holdout.

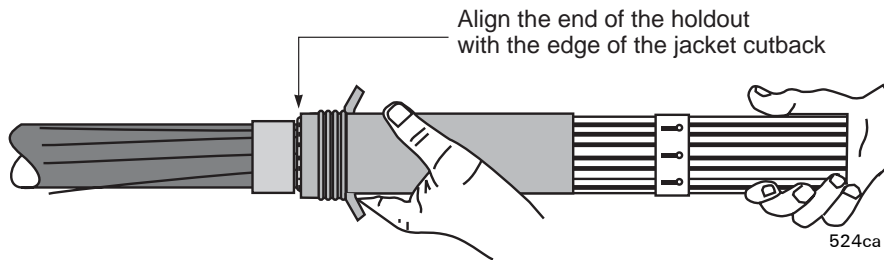

Slide the termination off the holdout with a twisting motion holding the termination that is on the holdout in one hand and pulling the holdout with the other.

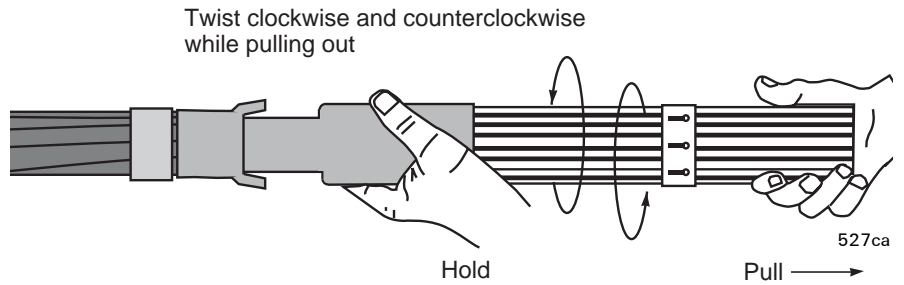

**Note: Do NOT stretch the termination.**

Do NOT hold the termination that is partially installed and attempt to pull the remaining termination off the holdout, as this will stretch the termination and generate an improperly installed termination if not repositioned.

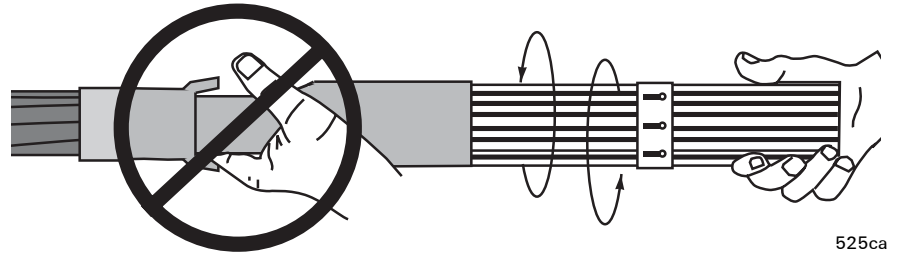

Using the pull tabs, pull the flip-back portion away from the main termination, at the same time working the first two fingers of each hand between the flip-back and main termination. Pull the stretched out flip-back over the cable jacket and sealant.

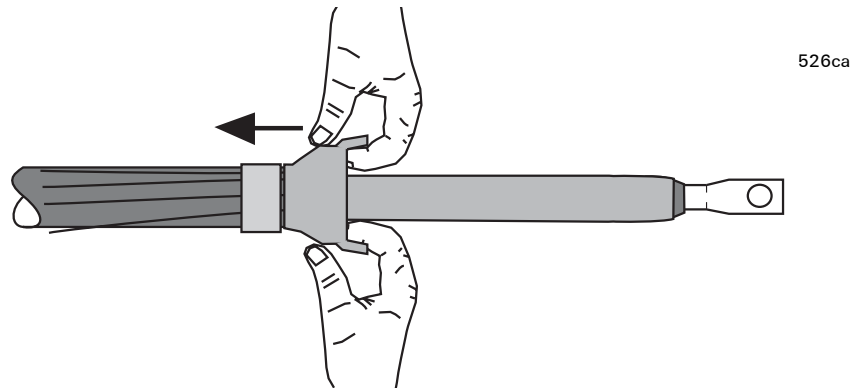

If the termination is not correctly positioned after installation, it is possible to gently slide it into place, so that the final assembly is positioned as shown in the drawing in step 9.

## 9. Clean termination

534la

Wipe over the surface of the termination to remove any dirt or grease.

The finished length of the termination should be approximately 10.0" (255mm) as shown.

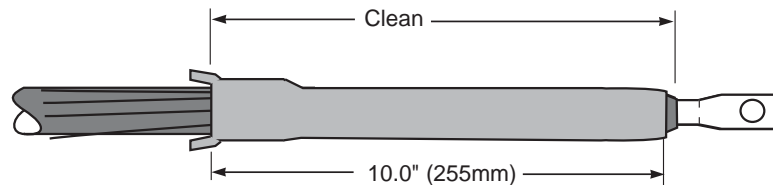

**This completes the installation.**



# UniShield Cables

## 1. Prepare cables

Determine insulation cutback length Z.



**Figure 1: Insulation Cutback (Z)**

**Note:** If no lug is used, Z = 2" (50mm)

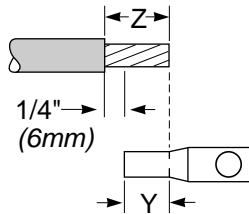

$$\text{"Z" Insulation Cutback} = \text{"Y" Length of Lug Barrel} + \frac{1}{4} \text{ (6mm)}$$

481

Refer to Figure 1 and adjacent drawing to prepare the cable as shown. Pull back drain wires as shown before cutting semi-con/jacket.

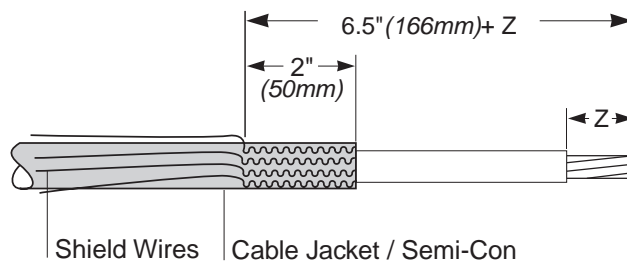

514

## 2. Make Lug Connection

Crimp the connector using proper die and tool. Clean lug barrel of inhibitor and dirt and file off any sharp edges.

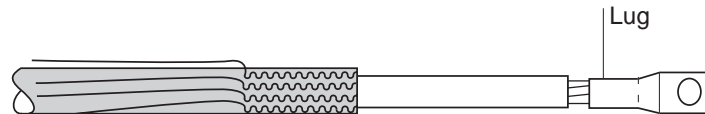

518g

## 3. Abrade (sand) and clean insulation

Abrade and clean the surface of the primary insulation using the solvent supplied with the termination or any other approved solvent. Be sure to remove any conductive particles or contamination.

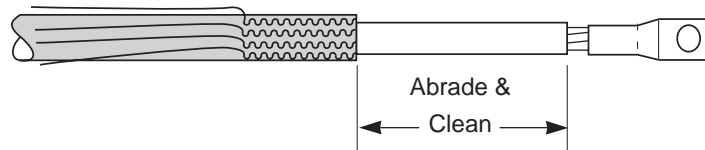

518h

**Note:** Use aluminum oxide abrasive strip only.

#### 4. Install sealant

Start wrapping sealant at end of lug barrel. Continue wrapping (no "half laps") until sealant is same thickness as insulation (at least two wraps).

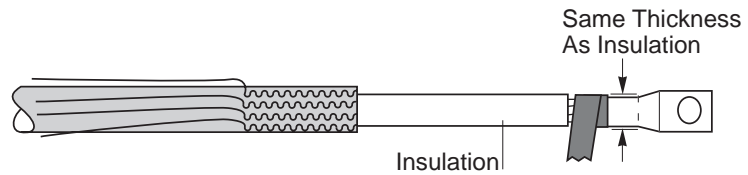
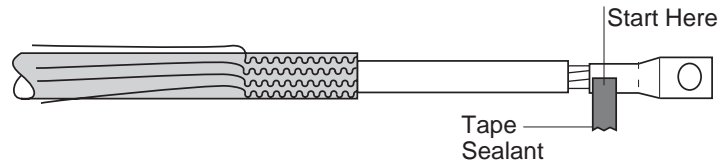

Continue wrapping on to the cable insulation for 1/2". Snap off any additional mastic.

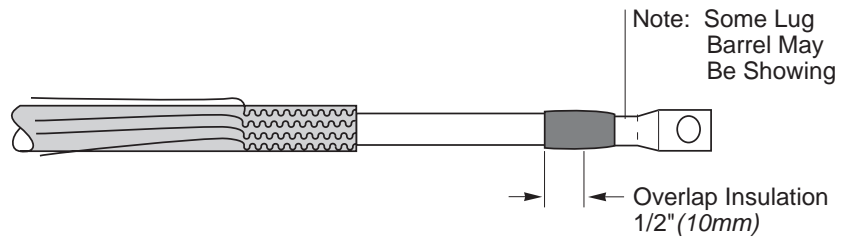

#### 5. Apply tape sealant

Lift the drain wires away from the cable jacket. Solvent clean and abrade jacket. Using light tension, wrap one layer of sealant onto the jacket as shown.

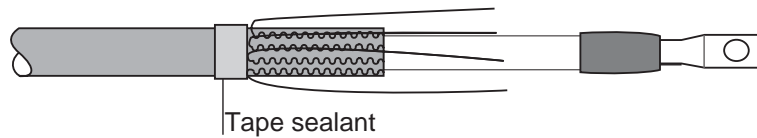

Lay the drain wires evenly back over the jacket and press them into the sealant.

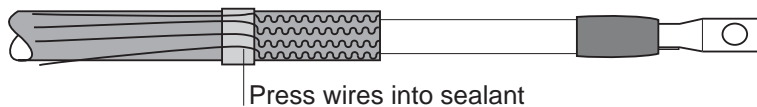

Wrap an additional layer of sealant over the drain wires and previously applied sealant.

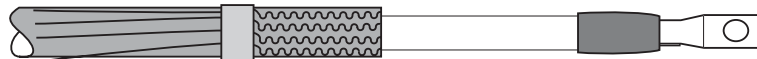

## 6. Apply Stress Patch

**Note:** The stress patch easily sticks to itself and loose particles.

**Note:** The patch may be rectangular. Follow the direction of the arrow on the backing paper of the stress patch. Longer dimension goes around the cable.

Remove backing paper from the patch. Using light tension and overlapping the semi-con by 1" (25mm), wrap the entire patch around the semi-con jacket as shown. Avoid wrinkles and creases.

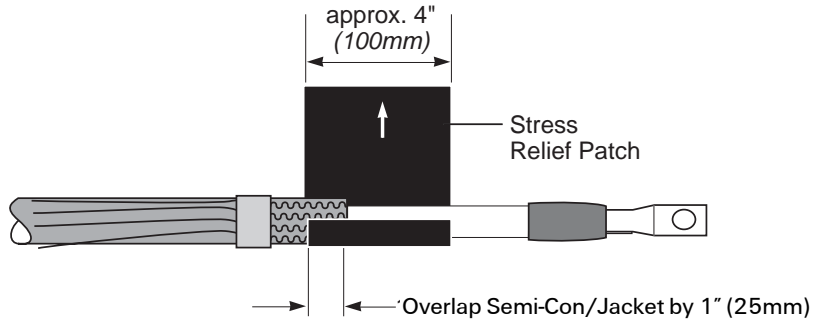

519e

## 7. Loosening Termination

***This operation is vital to the simple installation of the product.***

Hold the termination in one hand and the holdout in the other. Gripping firmly, twist the termination and holdout in opposite directions. Repeat twisting the termination and holdout, moving the hand in short increments up the termination until the entire termination is felt to move on the holdout. Slide the termination until it lines up with the end of the holdout tube as shown.

**Note:** Take care not to slide the termination off the end of the holdout. Stop the termination about 1/4" from the end of the holdout.

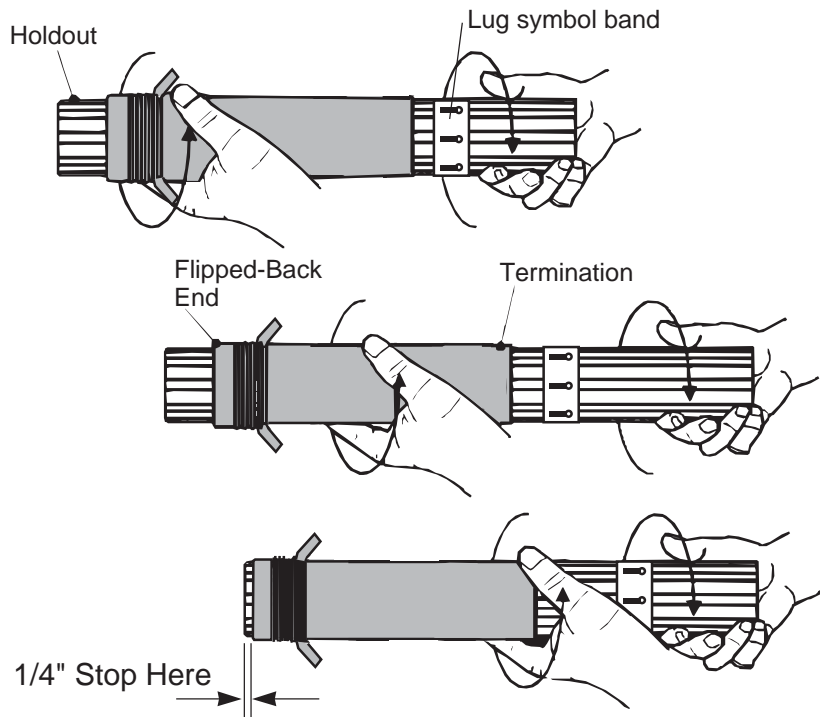

523ca

## 8. Installing termination

Position the holdout over the cable until it meets the jacket cutback. Twist the termination and slowly push it to the end of the holdout.

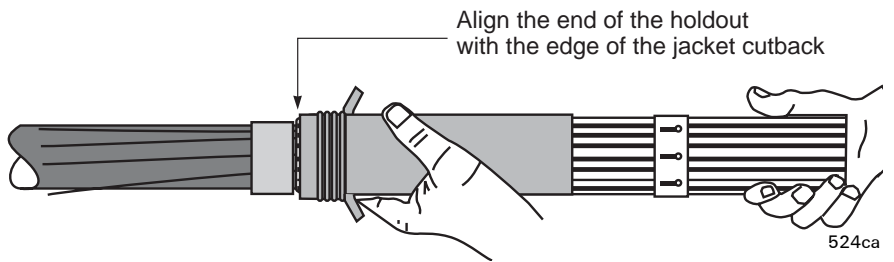

Slide the termination off the holdout with a twisting motion holding the termination that is on the holdout in one hand and pulling the holdout with the other.

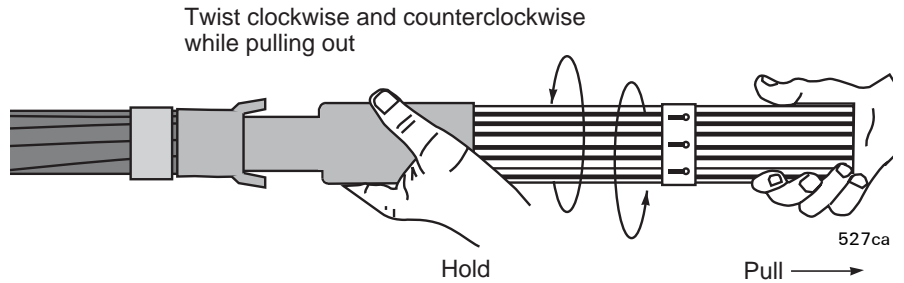

**Note: Do NOT stretch the termination.**

Do NOT hold the termination that is partially installed and attempt to pull the remaining termination off the holdout, as this will stretch the termination and generate an improperly installed termination if not repositioned.

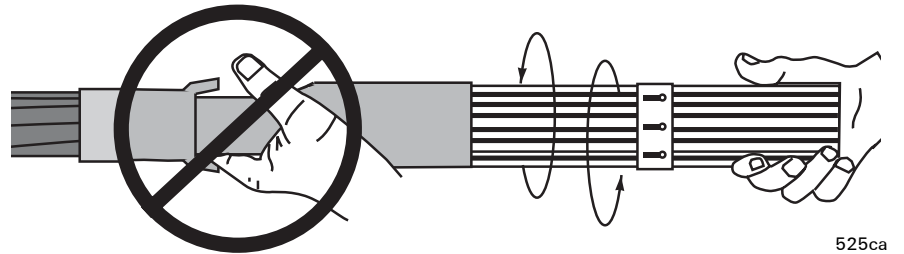

Using the pull tabs, pull the flip-back portion away from the main termination, at the same time working the first two fingers of each hand between the flip-back and main termination. Pull the stretched out flip-back over the cable jacket and sealant.

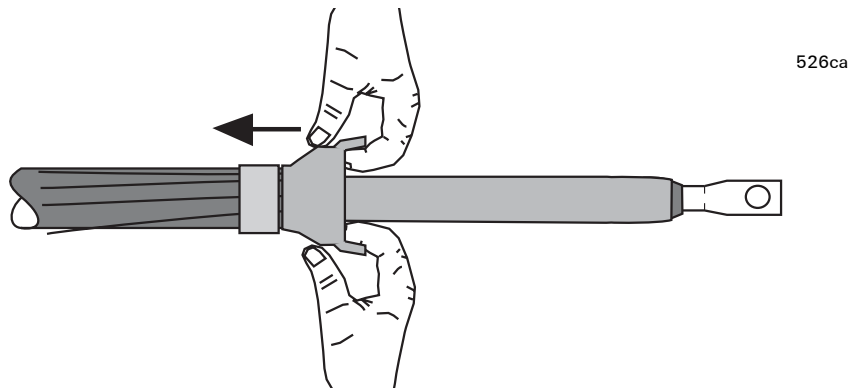

If the termination is not correctly positioned after installation, it is possible to gently slide it into place, so that the final assembly is positioned as shown in the drawing in step 9.

## 9. Clean termination

534la

Wipe over the surface of the termination to remove any dirt or grease.

The finished length of the termination should be approximately 10.0" (255mm) as shown.

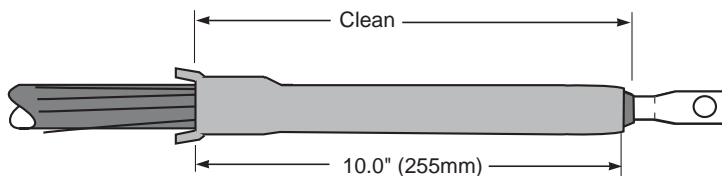

**This completes the installation.**



# Lead Sheath Cables

## 1. Prepare cables.

Determine insulation cutback length Z.



**Figure 1: Insulation Cutback (Z)**

**Note:** If no lug is used, Z = 2" (50mm)

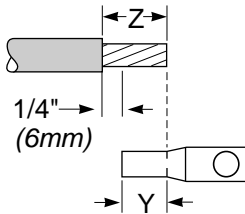

$$\text{"Z" Insulation Cutback} = \text{"Y" Length of Lug Barrel} + \frac{1}{4}'' (6\text{mm})$$

481

Refer to Figure 1 and adjacent drawing to prepare the cable as shown.

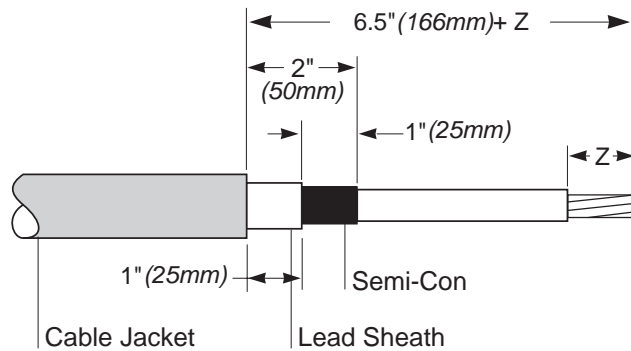

512a

## 2. Install ground braid

Flare the moisture blocked end of the ground braid and place it onto the lead sheath butted up to the cable jacket and solder to the lead sheath.

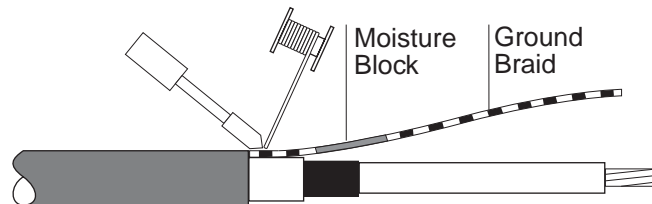

519y

## 3. Make Lug Connection

Crimp the connector using proper die and tool. Clean lug barrel of inhibitor and dirt and file off any sharp edges.



518b

## 4. Abrade (sand) and clean insulation

Abrade and clean the surface of the primary insulation using the solvent supplied with the termination or any other approved solvent. Be sure to remove any conductive particles or contamination.

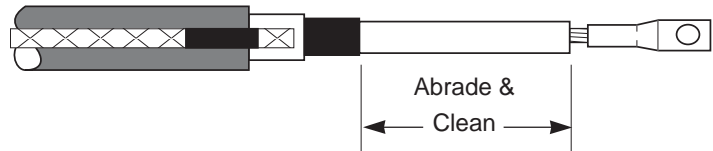

518d

**Note:** Use aluminum oxide abrasive strip only.

## 5. Install sealant

Start wrapping sealant at end of lug barrel. Continue wrapping (no "half laps") until sealant is same thickness as insulation (at least two wraps).

Continue wrapping on to the cable insulation for 1/2". Snap off any additional mastic.

Solvent clean and abrade (sand) jacket. Using light tension, wrap one layer of sealant onto the cable jacket, even with the jacket cutback as shown.

Press the solder-blocked portion of the braid into the sealant. Wrap an additional layer of sealant over the braid solder block, sandwiching the solder-block between layers of sealant.

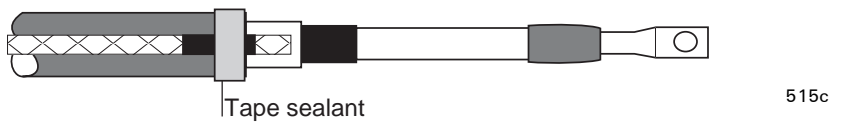
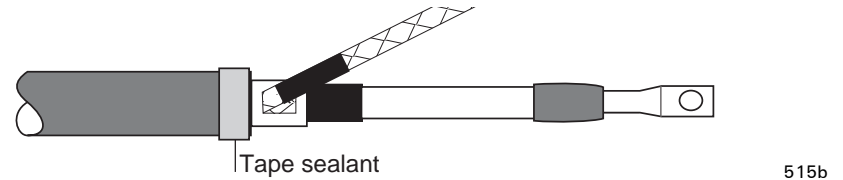
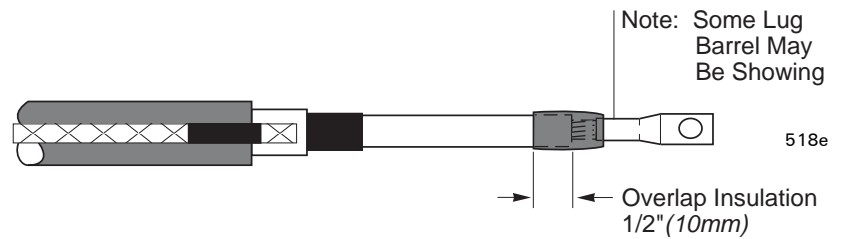
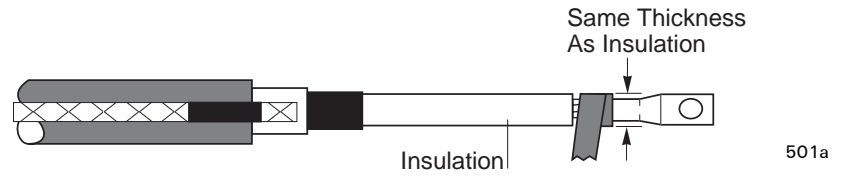
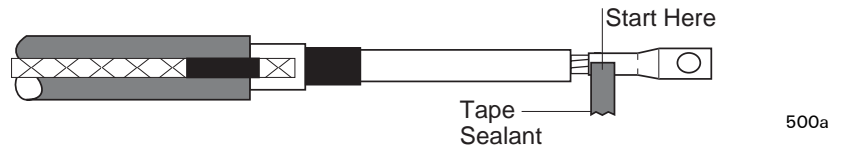

## 6. Apply Stress Patch

**Note:** The stress patch easily sticks to itself and loose particles.

**Note:** The patch may be rectangular. Follow the direction of the arrow on the backing paper of the stress patch. Longer dimension goes around the cable.

Remove backing paper from the patch. Using light tension and overlapping the semi-con by 1" (25mm), wrap the entire patch around the semi-con as shown. Avoid wrinkles and creases.

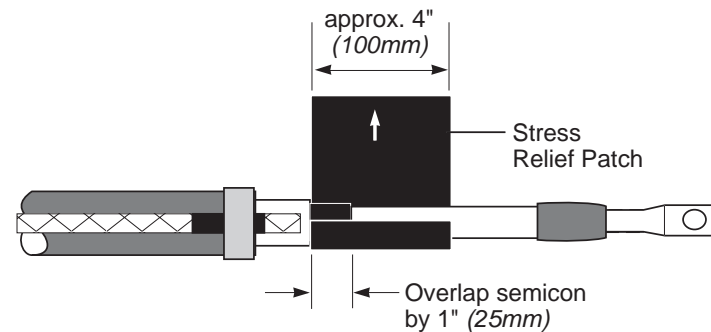



## 7. Loosening Termination

*This operation is vital to the simple installation of the product.*

Hold the termination in one hand and the holdout in the other. Gripping firmly, twist the termination and holdout in opposite directions. Repeat twisting the termination and holdout, moving the hand in short increments up the termination until the entire termination is felt to move on the holdout. Slide the termination until it lines up with the end of the holdout tube as shown.

**Note:** Take care not to slide the termination off the end of the holdout. Stop the termination about 1/4" from the end of the holdout.

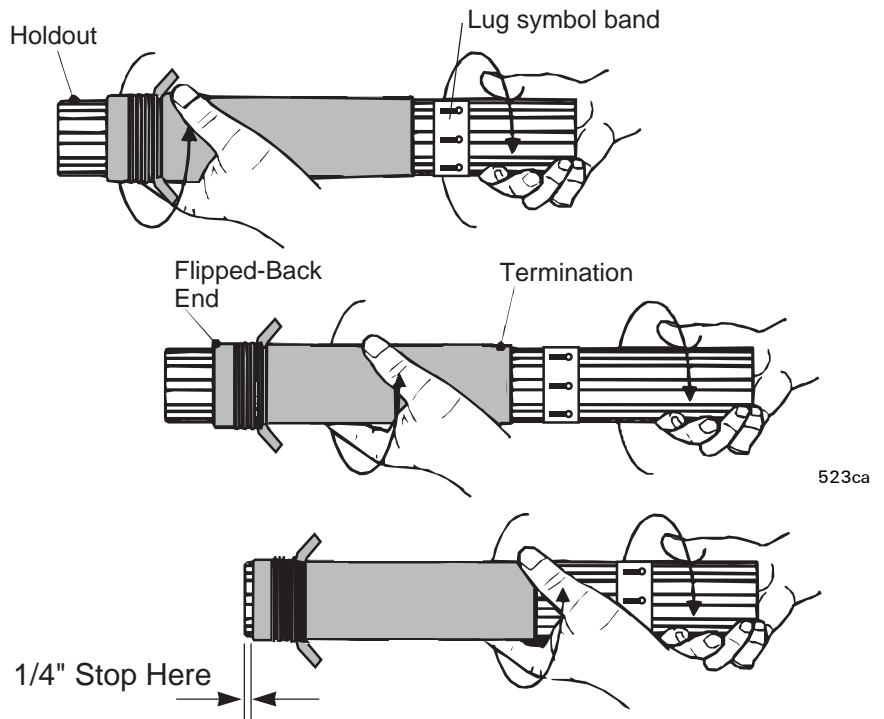

## 8. Installing termination

Position the holdout over the cable until it meets the jacket cutback. Twist the termination and slowly push it to the end of the holdout.

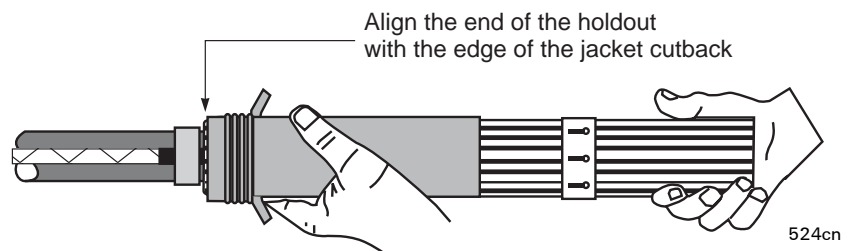

Slide the termination off the holdout with a twisting motion holding the termination that is on the holdout in one hand and pulling the holdout with the other.

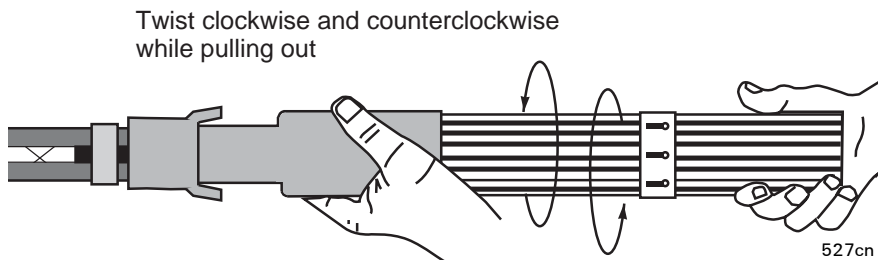

**Note:** Do NOT stretch the termination.

Do NOT hold the termination that is partially installed and attempt to pull the remaining termination off the holdout, as this will stretch the termination and generate an improperly installed termination if not repositioned.

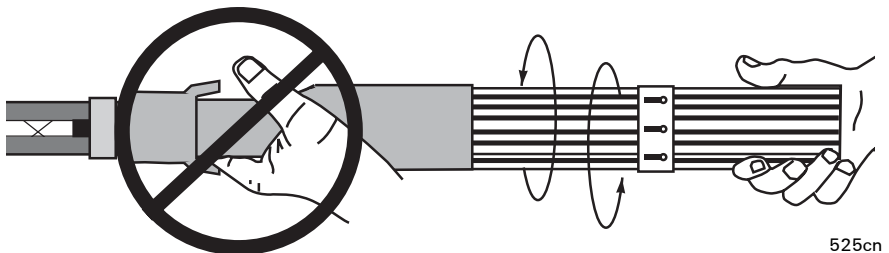

Using the pull tabs, pull the flip-back portion away from the main termination, at the same time working the first two fingers of each hand between the flip-back and main termination. Pull the stretched out flip-back over the cable jacket and sealant.

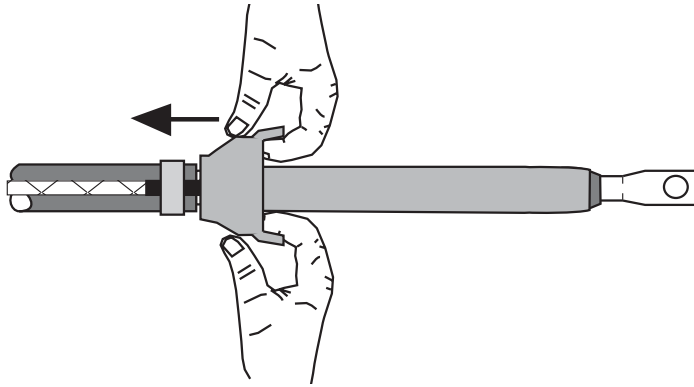

If the termination is not correctly positioned after installation, it is possible to gently slide it into place, so that the final assembly is positioned as shown in the drawing in step 9.

## 9. Clean termination

Wipe over the surface of the termination to remove any dirt or grease.

The finished length of the termination should be approximately 10.0" (255mm) as shown.

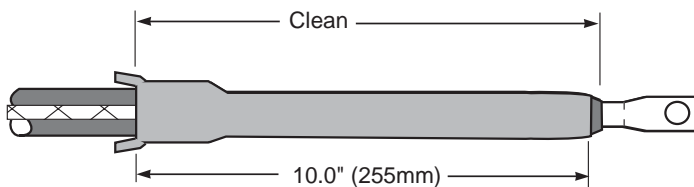

**This completes the installation.**

Unishield is a trademark of BICC General Cable Industries, Inc.



The Information contained in these installation instructions is for use only by installers trained to make electrical power installations and is intended to describe the correct method of installation for this product. However, Tyco Electronics has no control over the field conditions which influence product installation. It is the user's responsibility to determine the suitability of the installation method in the user's field conditions. Tyco Electronics' only obligations are those in Tyco Electronics' standard Conditions of Sale for this product and in no case will Tyco Electronics be liable for any other incidental, indirect or consequential damages arising from the use or misuse of the products. Raychem is a trade mark of Tyco Electronics Corporation.