

tyco

Electronics

Energy Division

Product Installation Instructions

HVS-3-1520S 15kV Class

Splice for 3/C Extruded
Dielectric (Poly/EPR) Power
Cable: Metallic Tape,
WireShield, or UniShield[®]*
Cable

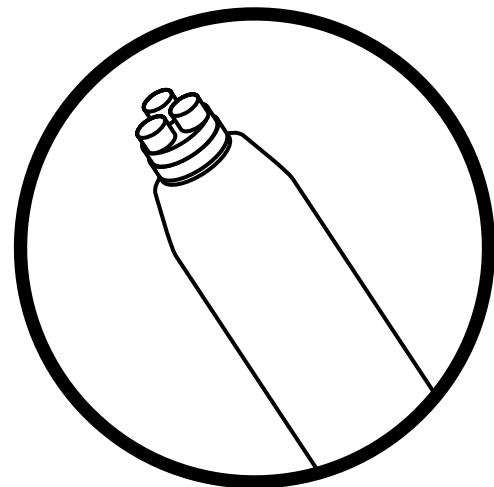

* UniShield is a registered trademark of BICC General Cable Industries, INC.

Raychem

Tyco Electronics Corporation
Energy Division
8000 Purfoy Road
Fuquay-Varina, NC 27526

PII- 53176, Rev AE
PCN 366825-000
Effective Date: October 4, 2002

Suggested Installation Equipment (not supplied with kit)

- Cable preparation tools
 - Tyco Electronics P63 cable preparation kit or cable manufacturer approved solvent
 - Clean, lint-free cloths
 - Non-conducting abrasive cloth, 120 grit or finer
 - Electrician's tape
 - Connector(s) and installation tools
 - Tyco Electronics recommended torch
-

Recommended Tyco Electronics Torches

Install heat-shrinkable cable accessories with a "clean burning" torch, i.e., a propane torch that does not deposit conductive contaminants on the product.

Clean burning torches include the Tyco Electronics FH-2629 (uses refillable propane cylinders) and FH-2616A1 (uses disposable cylinder).

Safety Instructions

Warning: When installing electrical power system accessories, failure to follow applicable personal safety requirements and written installation instructions could result in fire or explosion and serious or fatal injuries.

To avoid risk of accidental fire or explosion when using gas torches, always check all connections for leaks before igniting the torch and follow the torch manufacturer's safety instructions.

To minimize any effect of fumes produced during installation, always provide good ventilation of confined work spaces.

As Tyco Electronics has no control over field conditions which influence product installation, it is understood that the user must take this into account and apply his own experience and expertise when installing product.

Adjusting the Torch

Adjust regulator and torch as required to provide an overall 12- inch bushy flame. The FH-2629 will be all blue, the other

torches will have a 3- to 4-inch yellow tip. Use the yellow tip for shrinking.

Regulator Pressure

FH-2616A1	Full pressure
FH-2629	15 psig

Cleaning the Cable

Use an approved solvent, such as the one supplied in the P63 Cable Prep Kit, to clean the cable. Be sure to follow the manufacturer's instructions. Failure to follow these instructions could lead to product failure.

Some newer solvents do not evaporate quickly and need to be removed with a clean, lint-free cloth. Failure to do so could change the volume resistivity of the substrate or leave a residue on the surface.

Please follow the manufacturer's instructions carefully.

General Shrinking Instructions

- Apply outer 3- to 4-inch tip of the flame to heat-shrinkable material with a rapid brushing motion.
- Keep flame moving to avoid scorching.
- Unless otherwise instructed, start shrinking tube at center, working flame around all sides of the tube to apply uniform heat.

To determine if a tube has completely recovered, look for the following, especially on the back and underside of the tube:

1. Uniform wall thickness.
2. Conformance to substrate.
3. No flat spots or chill marks.
4. Visible sealant flow if the tube is coated.

Note: When installing multiple tubes, make sure that the surface of the last tube is still warm before positioning and shrinking the next tube. If installed tube has cooled, re-heat the entire surface.

Installation Instructions

1. Product selection.

Check kit selection with cable diameter dimensions in Table 1.

Note: Table is for 100% insulated cable. For 133% insulated cable, check actual cable dimensions.

2. Check ground braid.

Verify that ground braid(s) or bond wire have equivalent cross-section to cable metallic shield. Additional braid may be needed for LC shield, lead sheath cables, or if external grounding or shield interrupting is required.

Tyco Electronics HVS-EG-3 supplies ground braid, spring clamp and suggested modifications to make an external ground or shield interrupt.

Table 1

Kit	Nominal Cable Range	Minimum Jacket Diameter	Insulation Diameter Range	Maximum Connector Dimensions	
				Diameter	Length
Dimensions in inches					
HVS-3-1521S	#2-4/0 AWG	1.30	0.65-1.05	0.90	4.25
HVS-3-1522S	250-350 kcmil	1.55	0.90-1.30	1.15	5.5
HVS-3-1523S	500-750 kcmil	1.55	1.10-1.60	1.60	8.0
HVS-3-1524S	750-1000 kcmil	2.40	1.25-1.80	1.85	8.0
Dimensions in millimeters					
HVS-3-1521S	#2-4/0 AWG	33	17-27	23	108
HVS-3-1522S	250-350 kcmil	39	23-33	29	140
HVS-3-1523S	500-750 kcmil	39	28-41	41	203
HVS-3-1524S	750-1000 kcmil	61	32-46	47	203

3. Prepare cables.

Choose the cable type (Choice 1-3) and use the dimensions shown in Table 2 to prepare the cables.

Table 2

Kit	Jacket Cutbacks		Metallic Shield Cutback/ Wire Pullback		Semi-con Cutback
	A1	A2	B		C
HVS-3-1521S	28" (711mm)	19-1/2" (495mm)	8" (203mm)		4-1/2" (115mm)
HVS-3-1522S	29" (737mm)	22" (559mm)	9" (230mm)		5" (125mm)
HVS-3-1523S	31" (787mm)	24" (610mm)	10" (255mm)		6-1/2" (165mm)
HVS-3-1524S	34" (864mm)	25" (635mm)	10-1/2" (265mm)		6-1/2" (165mm)

CHOICE 1

If Metallic Tape Shield Cable

Refer to Table 2 and prepare the cables as shown. Remove any fillers to the armor cutback. Bend back the grounding conductor(s) over the jacket as shown.

Go to Step 4, page 5.

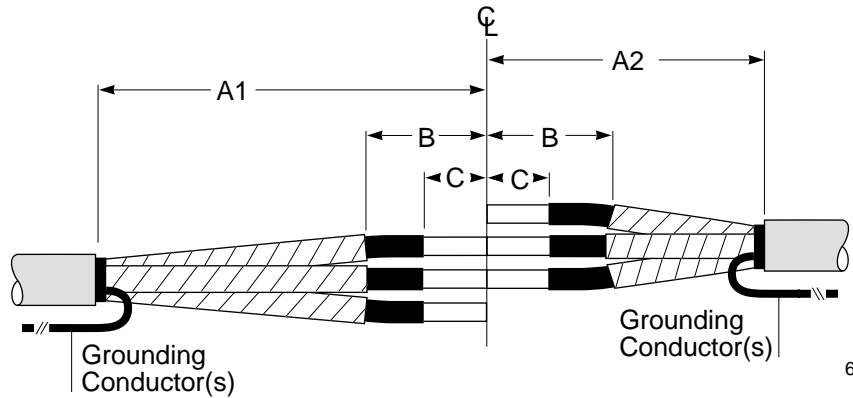

694

CHOICE 2

If Drain Wire Shield Cable

Refer to Table 2 and prepare the cables as shown. Remove any fillers to the armor cutback. Pull drain wires back to Dimension B and temporarily tape over ends as shown. Bend back the grounding conductor(s) over the jacket as shown.

Go to Step 4, page 5.

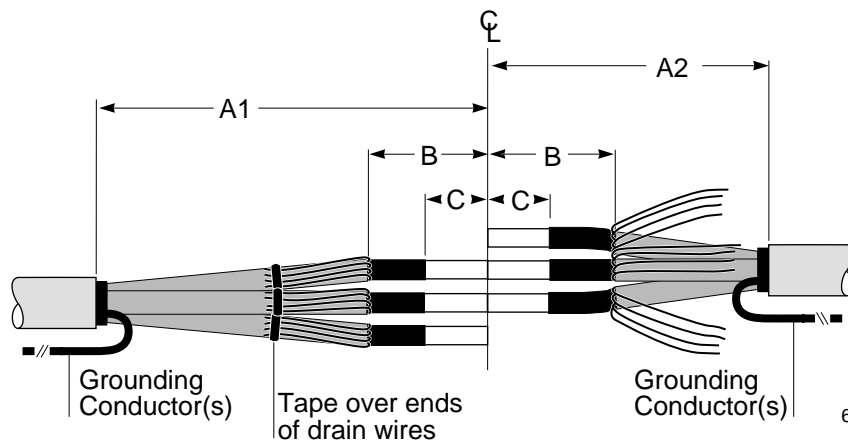

695

CHOICE 3

If UniShield Cable

Refer to Table 2 and prepare the cables as shown. Remove any fillers to the armor cutback. Pull drain wires back to Dimension B and temporarily tape over ends as shown. Bend back the grounding conductor(s) over the jacket as shown.

Go to Step 4, page 5.

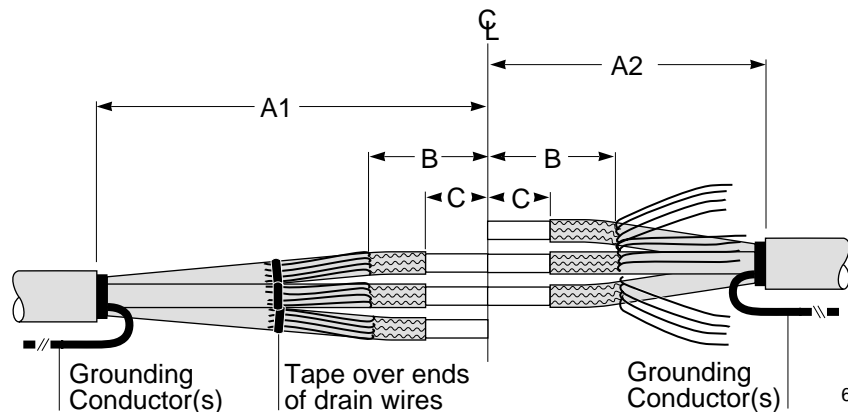

696

4. Remove insulation.

Refer to Table 3 and Figure 1; cutback insulation as shown.

Table 3

Kit	Maximum Connector Dimensions		Expansion Gap "X"
	Length	Diameter	
HVS-3-1521S	4-1/4" (108mm)	1.00" (25mm)	1/4" (5mm)
HVS-3-1522S	5-1/2" (140mm)	1.35" (34mm)	1/4" (5mm)
HVS-3-1523S	8" (203mm)	1.60" (41mm)	1/2" (10mm)
HVS-3-1524S	8" (203mm)	1.85" (47mm)	1/2" (10mm)

Figure 1: Insulation Cutback

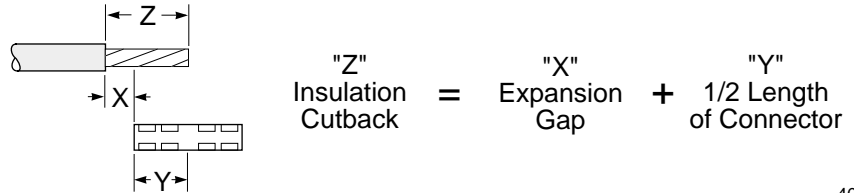

400

5. Abrade insulation.

Abrade the insulation, if necessary, to remove imbedded semi-con and clean as shown.

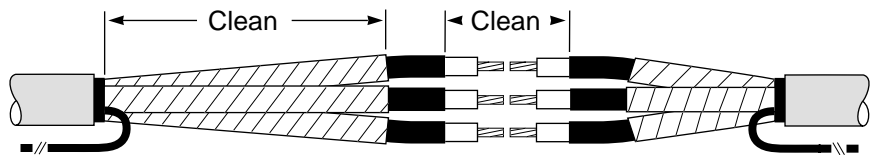

697

6. Place nested tubes over phases.

Place one set of nested tubes over each phase as shown.

Protect tubes from end of conductor as they are placed over cable end.

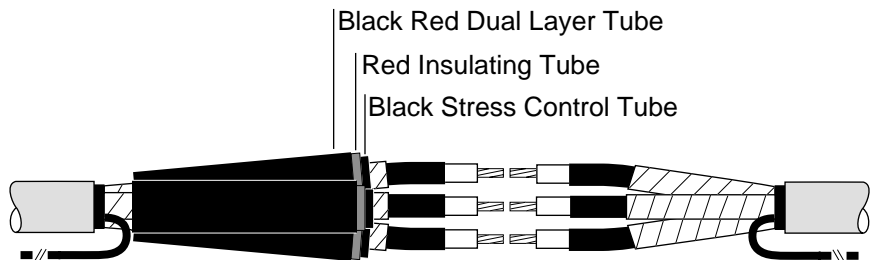

698

7. Install connector.

After installation, deburr connector.

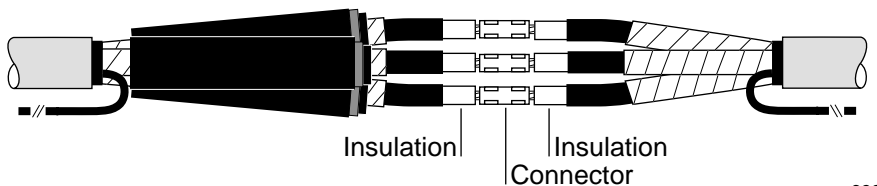

699

Installation Instructions

8. Apply SRM over connector.

Complete Steps 8-11 working on one phase at a time.

Clean connector area and insulation, as shown, using an approved solvent.

Remove backing from one side of the *long strip* of Stress Relief Material (SRM). Roll the SRM and remaining backing strip into a convenient size. Remove the remaining backing strip and tightly wrap the SRM around the connector and exposed conductor. Be sure to fill the gaps and low spots around the connector.

Continue to wrap SRM onto the solvent cleaned insulation as shown.

Note: If connector diameter is larger than insulation diameter, apply two half-lapped layers of SRM over the entire connector. Discard any excess SRM (long strips).

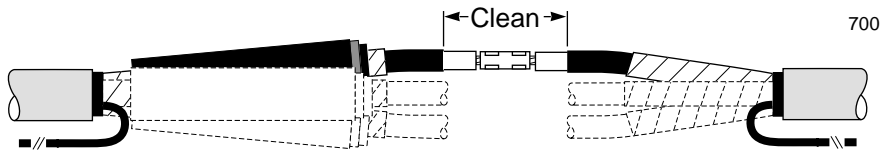

700

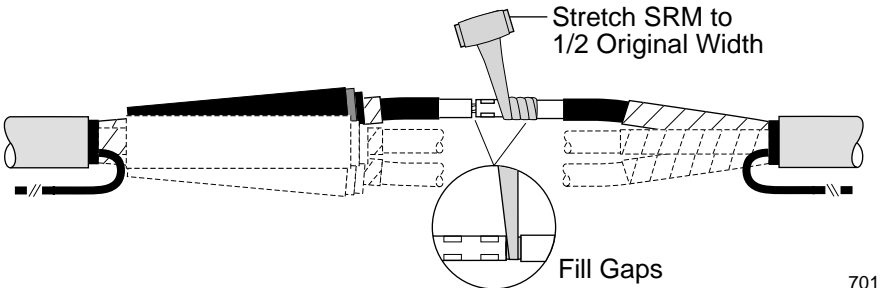

701

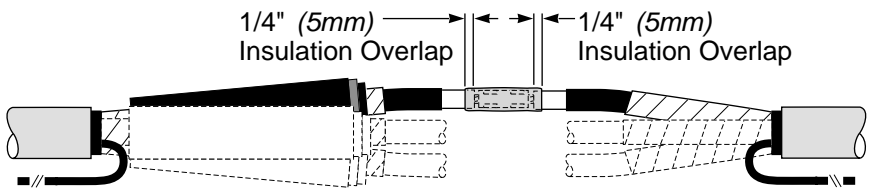

702

9. Apply SRM at semi-con cutback.

Remove backings from the *short angle-cut piece* of SRM. Place tip of SRM at semi-con cutback and tightly wrap to fill semi-con step. Overlap semi-con and insulation as shown. Taper SRM down to meet insulation.

Note: If using UniShield cable, apply SRM as shown to fill conductive jacket step.

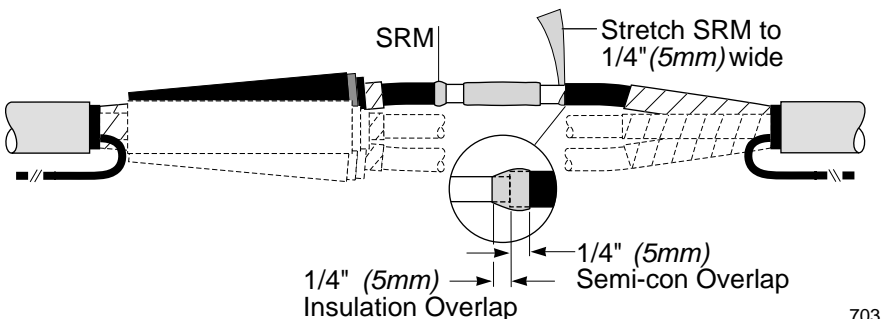

703

10. Apply Discharge Control Compound (DCC).

Snip open the end of the DCC ampule and apply a thin film of compound over the three applications of SRM.

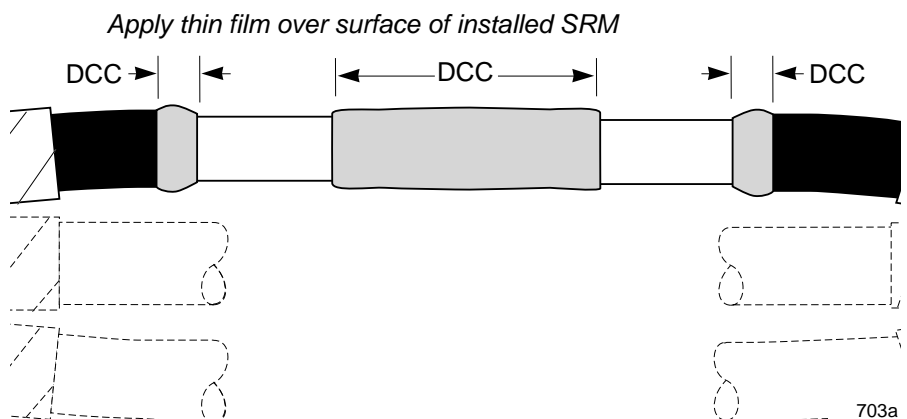

703a

11. Position tube over connection.

Center black stress control tube over completed connector area.

Repeat Steps 8-11 on the remaining phases.

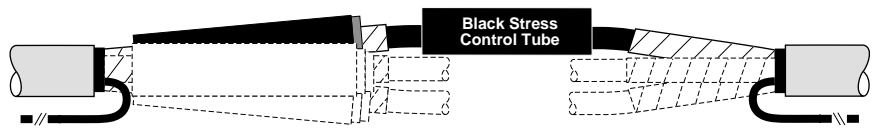

12. Check position of Black Stress Control tubes; shrink in place.

Center the tubes over the splice. Begin shrinking at the center (1) of the tubes, working the torch around all sides of the tubes. After the center portion shrinks, work towards one end (2), then to the opposite end (3).

Note: Do not point the flame at the cable semi-con.

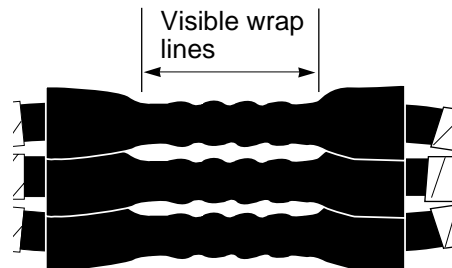
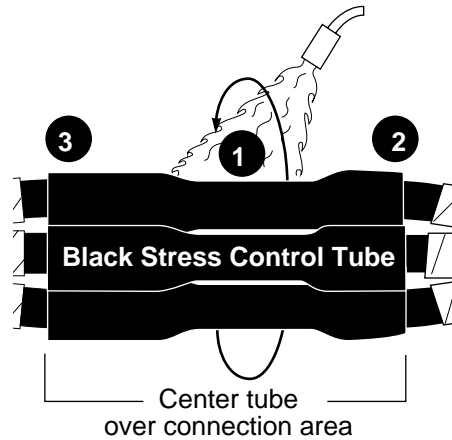

The rings from the SRM wraps may be visible as the tubing shrinks.

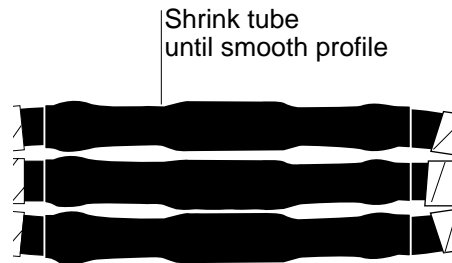

Post heat the connector area until the tube surface is smooth and the underlying SRM wraps are no longer visible.

13. Position Red Insulating tubes; shrink in place.

Center the red insulating tubes over the black stress control tubes. Shrink all three tubes in place at the same time, using the same method as in Step 12.

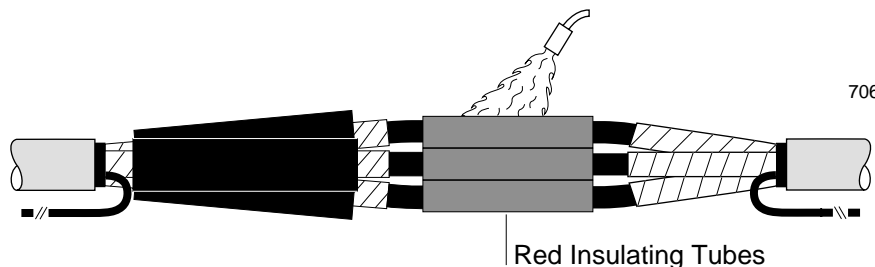

14. Apply red sealant.

Remove backing from red sealant. Using light tension, wrap sealant over each cable phase, butted against the tubes as shown. Build the sealant to the level of the red insulating tube.

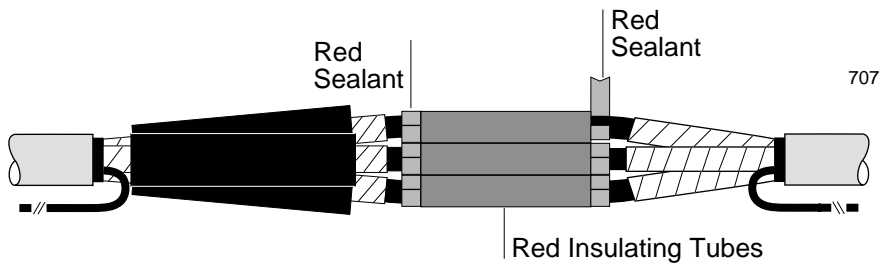

707

15. Position Black/Red Dual Layer tubes; shrink in place.

Center black/red dual layer tubes over red insulating tubes. Shrink all three tubes in place at the same time, using the same method as in Step 12.

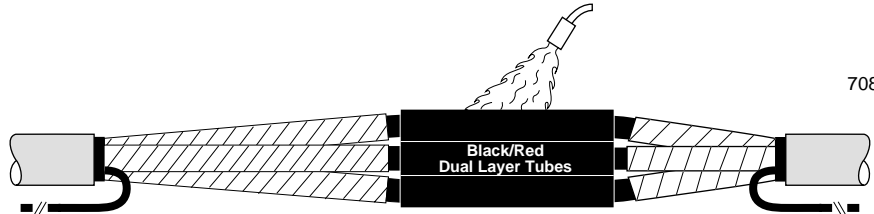

708

16. Install ground.

Choose the appropriate cable type (Choice 1 and 2) and follow the directions given.

Note: If External Grounding.

Refer to Tyco Electronics HVS-EG-3, "Guide for External Grounding of Power Cable Splices" for modifications to these instructions.

CHOICE 1

If Metallic Tape Shield Cable

(1) Flare one end of the ground braid and place it onto the metallic tape butted up to the installed splice tube. (2) Attach the braid to the shield by placing two wraps of the spring clamp over the braid. (3) Fold the braid back over the spring clamp wraps. Continue to wrap the remaining clamp over the braid. Tighten clamp by twisting it in the direction it is wrapped and secure with copper foil tape provided.

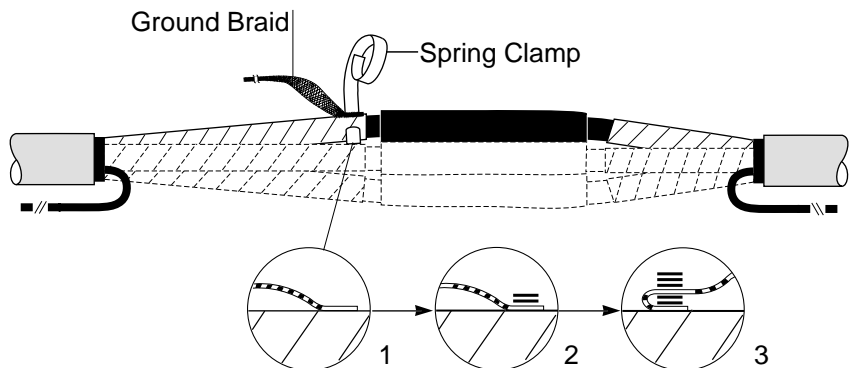

709

(4) Lay the braid across the splice tube and onto the exposed tape shield on the other side. (5) Make two wraps of the clamp over the braid. (6) Fold the braid back toward the splice and finish wrapping the clamp. Tighten and secure. Cut off excess braid. Repeat Choice 1 for remaining phases.

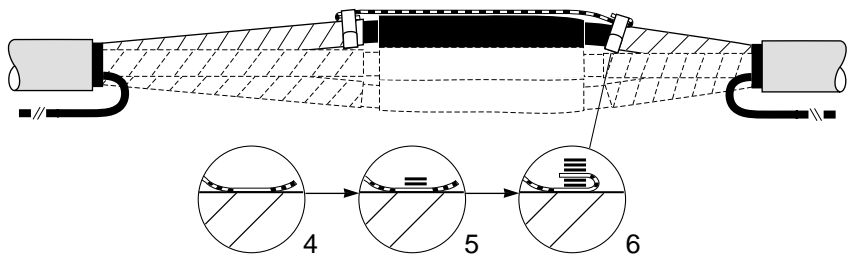

Discard connectors.

Go to Step 17, page 9.

710

CHOICE 2

If Drain Wire or UniShield Cable

Pigtail the wires on each side.
Crimp the ground braid onto one pigtail with the connector provided.

Lay braids across splice tubes and attach to pigtail on the other side.
Cut off excess braid and trim pigtailed wires. Repeat Choice 2 for remaining phases.

Discard spring clamps and foil tape.

Go to Step 17.

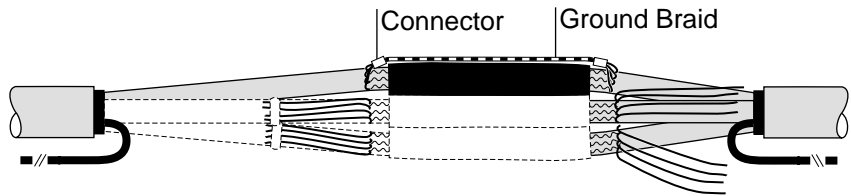

711

17. Connect grounding conductor(s).

Bend the grounding conductor(s) back over the tubes and splice with a suitable connector.

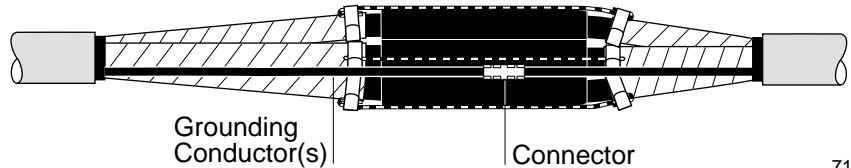

712

18. Install the shielding mesh.

Starting on the cable shields, wrap a half-lapped layer of the mesh around all three phases across the length of the tubes and tie off on the shields at the other side of the splice.

Abrade and solvent clean cable jackets as shown to provide an oil-free surface.

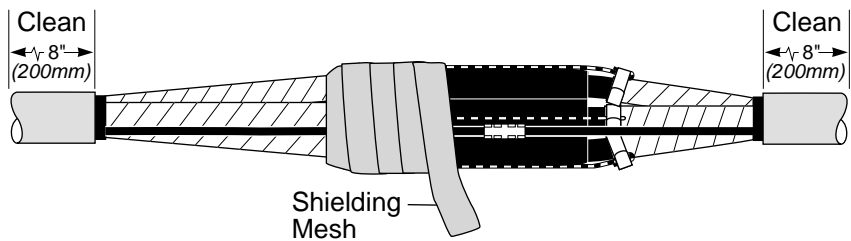

713

19. Position wraparound sleeve.

Remove or tape over all sharp points to prevent puncture of wraparound sleeve.

Remove backing from the wraparound sealing sleeve and center sleeve over splice. Slide metal channels onto the butted rails.

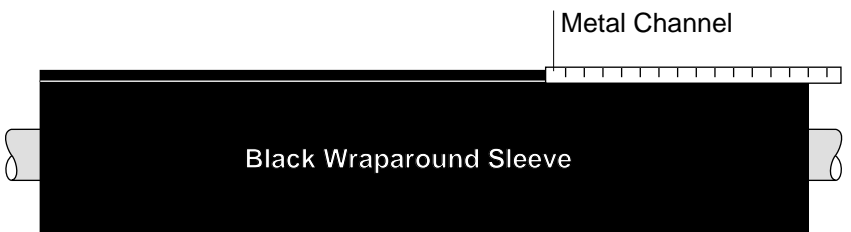

714

20. Install channel clip.

Use channel retention clips to connect channels. Use pliers to install clip(s).

Note: Channels must overlap sleeve edge by 1/4" (5mm) minimum.

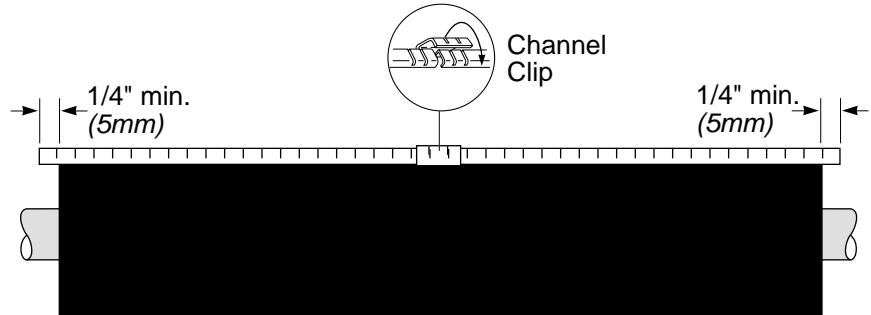

715

21. Shrink the wraparound sleeve.

Begin shrinking at the center and work toward each end. Post heat the entire sleeve (concentrating on metal channel area) for 30 seconds after completely shrunk.

This completes the splice.

Note: Allow to cool before moving or placing in service.

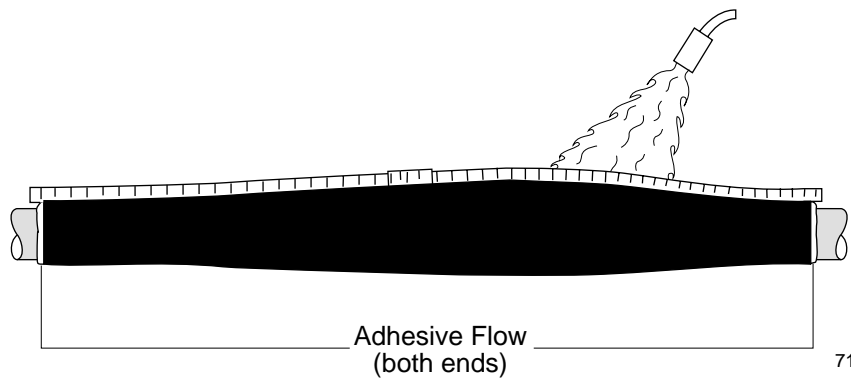

716

The Information contained in these installation instructions is for use only by installers trained to make electrical power installations and is intended to describe the correct method of installation for this product. However, Tyco Electronics has no control over the field conditions which influence product installation. It is the user's responsibility to determine the suitability of the installation method in the user's field conditions. Tyco Electronics' only obligations are those in Tyco Electronics' standard Conditions of Sale for this product and in no case will Tyco Electronics be liable for any other incidental, indirect or consequential damages arising from the use or misuse of the products. Raychem is a trademark of Tyco Electronics Corporation.