

# HVS-T-1580E-S

15kV Class Trifurcating Transition Splice for 3/C PIL to 3 1/C Extruded Dielectric (Poly/EPR) Power Cables

## ENERGY DIVISION

### Suggested Installation Equipment (not supplied with kit)

- Cable preparation tools
- Tyco Electronics P63 cable preparation kit or cable manufacturer approved solvent
- Clean, lint-free cloths
- Non-conducting abrasive cloth, 120 grit or finer
- Electrician's tape
- Connector(s) and installation tools
- Tyco Electronics recommended torch

### Safety Instructions

**DANGER:** When installing electrical power system accessories, failure to follow applicable personal safety requirements and written installation instructions could result in fire or explosion and serious or fatal injuries.

To avoid risk of accidental fire or explosion when using gas torches, always check all connections for leaks before igniting the torch and follow the torch manufacturer's safety instructions.

To minimize any effect of fumes produced during installation, always provide good ventilation of confined work spaces.

*As Tyco Electronics has no control over field conditions which influence product installation, it is understood that the user must take this into account and apply his own experience and expertise when installing product.*

### Recommended Tyco Electronics Torches

Install heat-shrinkable cable accessories with a "clean burning" torch, i.e., a propane torch that does not deposit conductive contaminants on the product.

Clean burning torches include the Tyco Electronics FH-2629, FH-2649 (uses refillable propane cylinders) and FH-2618A (uses disposable cylinder).

### Adjusting the Torch

Adjust regulator and torch as required to provide an overall 12-inch bushy flame. The FH-2629 will be all blue, the other torches will have a 3- to 4-inch yellow tip. Use the yellow tip for shrinking.

### Regulator Pressure

FH-2618A	Full pressure
FH-2649	25 psig
FH-2629	15 psig

### General Shrinking Instructions

- Apply outer 3- to 4-inch tip of the flame to heat-shrinkable material with a rapid brushing motion.
- Keep flame moving to avoid scorching.
- Unless otherwise instructed, start shrinking tube at center, working flame around all sides of the tube to apply uniform heat.

To determine if a tube has completely recovered, look for the following, especially on the back and underside of the tube:

1. Uniform wall thickness.
2. Conformance to substrate.
3. No flat spots or chill marks.
4. Visible sealant flow if the tube is coated.

*Note: When installing multiple tubes, make sure that the surface of the last tube is still warm before positioning and shrinking the next tube. If installed tube has cooled, re-heat the entire surface.*

# Installation Instructions

## 1. Product selection.

Check kit selection with cable diameter dimensions in Table 1.

## 2. Check ground braid.

Verify that ground braid(s) or bond wire have equivalent cross-section to cable metallic shield. Additional braid may be needed for LC shield, lead sheath cables, or if external grounding or shield interrupting is required.

Tyco Electronics HVS-EG supplies ground braid, spring clamp and suggested modifications to make an external ground or shield interrupt.

Kit	PILC/Poly Nominal Cable Range	PILC Insulation Diameter Range	Poly Insulation Diameter Range	Poly Maximum Jacket Diameter	Maximum Connector Dimensions	
					Length	Diameter
HVS-T-1581E-S	1/0-4/0	0.65-1.00" (17-25mm)	0.70-1.05" (18-27mm)	1.40" (36mm)	2.50" (63mm)	0.90" (23mm)
HVS-T-1582E-S	250-500	0.85-1.20" (22-30mm)	0.90-1.20" (23-30mm)	1.50" (38mm)	4.50" (114mm)	1.35" (34mm)
HVS-T-1583E-S	500-1000	1.10-1.50" (28-38mm)	1.15-1.75" (29-44mm)	2.20" (56mm)	5.00" (127mm)	1.85" (47mm)

## 3. Prepare cables

Choose the splice type (Choice 1-5) and follow the directions given.

Kit	Poly Jacket Cutback A	Poly Semi-con Cutback B	PILC Lead Sheath Cutback C*
HVS-T-1581E-S	10" (254mm)	4-1/2" (114mm)	15" (381mm)
HVS-T-1582E-S	11" (279mm)	5-1/2" (140mm)	16" (406mm)
HVS-T-1583E-S	11" (279mm)	6" (152mm)	17" (432mm)

\*If the 3/C PILC cable has an outer jacket, remove the jacket to dimension "C" plus 5.0" (127mm).

### CHOICE 1

If PILC to Metallic Tape Shield, Lead Sheath or LC Shield Cable

Refer to Table 2 and prepare the cables as shown.

Go to Step 4.

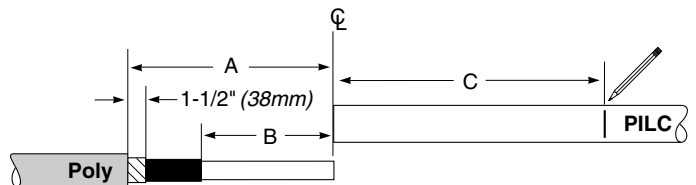

### CHOICE 2

#### If PILC to Drain Wire Shield Cable

Refer to Table 2 and prepare the cables as shown.

Go to Step 4.

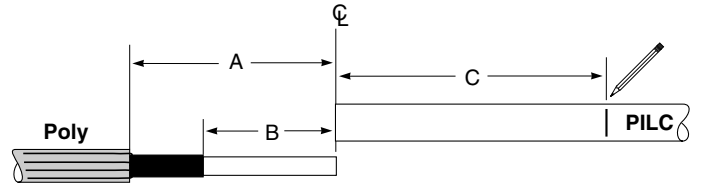

177

### CHOICE 3

#### If PILC to UniShield Cable

Refer to Table 2 and prepare the cables as shown. Pull back the drain wires to Dimension A.

Go to Step 4.

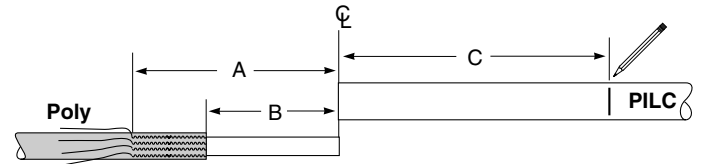

178

UniShield is a registered trademark of BICC General Cable Industries, INC.

### CHOICE 4

#### If PILC to Jacketed Concentric Neutral Cable

Refer to Table 3 and prepare the cables as shown. Cut neutral wires to dimension E and temporarily tape over ends.

Go to Step 4.

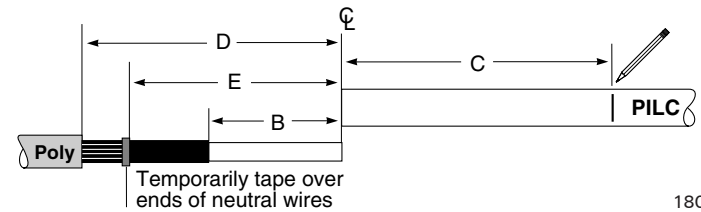

180

Table 3

Kit	Poly Jacket Cutback D	Poly Wire Cutback E	Poly Semi-con Cutback B	PILC Lead Sheath Cutback C*
HVS-T-1581E-S	14" (356mm)	9" (229mm)	4-1/2" (114mm)	15" (381mm)
HVS-T-1582E-S	15" (381mm)	10" (254mm)	5-1/2" (140mm)	16" (406mm)
HVS-T-1583E-S	16" (406mm)	10" (254mm)	6" (152mm)	17" (432mm)

\*If the 3/C PILC cable has an outer jacket, remove the jacket to dimension "C" plus 5.0"(127mm).

### CHOICE 5

#### If PILC to Concentric Neutral Cable

Refer to Table 4 and prepare the cables as shown. Cut neutral wires to Dimension F and temporarily tape over ends.

Go to Step 4.

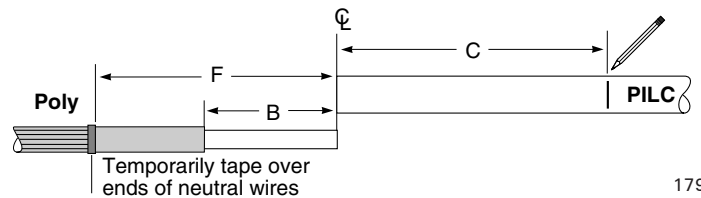

179

**Table 4**

Kit	Poly Wire Cutback F	Poly Semi-con Cutback B	PILC Lead Sheath Cutback C
HVS-T-1581E-S	12" (305mm)	4-1/2" (114mm)	15" (381mm)
HVS-T-1582E-S	13" (330mm)	5-1/2" (140mm)	16" (406mm)
HVS-T-1583E-S	14" (356mm)	6" (152mm)	17" (432mm)

\*If the 3/C PILC cable has an outer jacket, remove the jacket to dimension "C" plus 5.0"(127mm).

**4. Prepare lead sheath.**

Remove lead oxide from the lead sheath and clean with oil-free solvent.

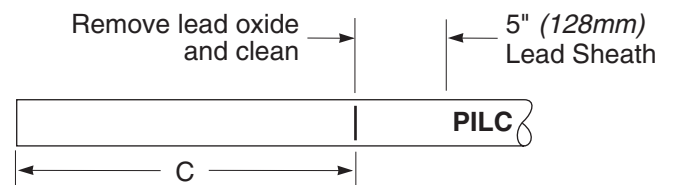

653

**5. Remove lead sheath as shown.**

Kit	Lead Sheath Cutback C
HVS-T-1581E-S	15" (381mm)
HVS-T-1582E-S	16" (406mm)
HVS-T-1583E-S	17" (432mm)

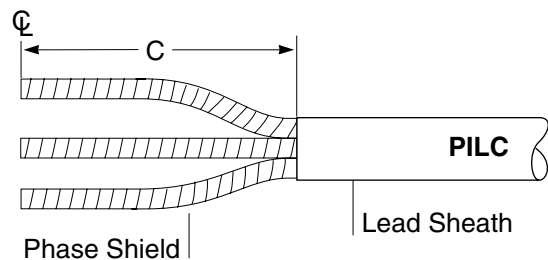

101

**6. Cut back shield or belt papers.**

Choose the cable type and follow the directions given.

**CHOICE 1**

**If Shielded PILC Cable**

Cut back any bedding and/or shielding tapes over all three phases to lead sheath cutback. Cut back phase shields and remove any conductive material from paper insulation as shown.

Tack solder metal tape shields to prevent unwrapping and tape over sharp edges with one wrap of electrician's tape.

Go to Step 7.

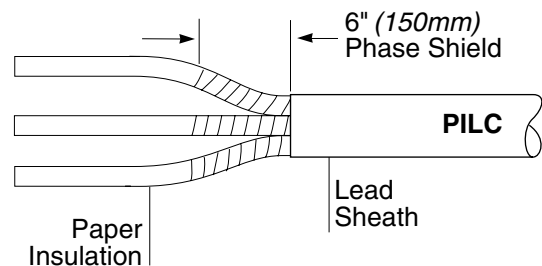

102

**CHOICE 2**

**If Belted PILC Cable**

Remove belt papers as shown.

Go to Step 7.

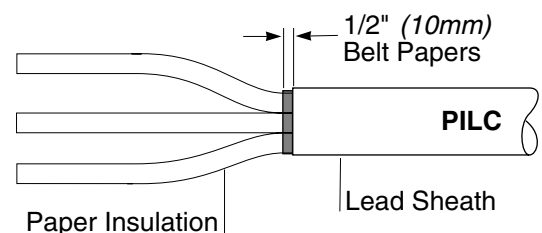

103

**7. Position OBT; shrink in place.**

Place a CLEAR Oil Barrier Tube (OBT) over each phase, butted to the lead sheath (or belt paper) cutback. Shrink the three OBTs in place starting at the lead sheath cutback.

**Note:** To achieve a smooth, wrinkle-free installation, use a reduced flame to install the thin-walled OBT.

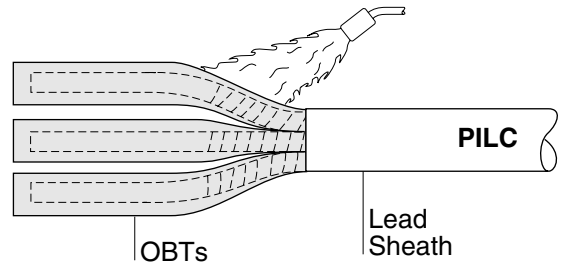

394

**8. Inspect OBTs.**

The installed OBTs should have a smooth, wrinkle-free surface after shrinking. Reheat to smooth any wrinkled areas.

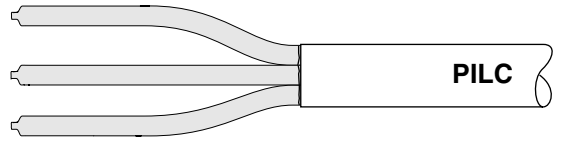

395

**9. Mark OBT/ Insulation at G.**

Kit	G
HVS-T-1581E-S	5-1/2" (140mm)
HVS-T-1582E-S	6-1/2" (165mm)
HVS-T-1583E-S	7" (178mm)

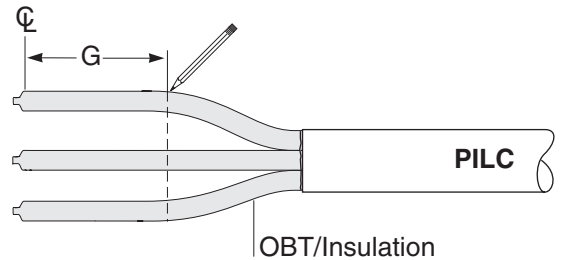

220

**10. Position black conductive tubes; shrink in place.**

Place black conductive tube over each phase and position at dimension G.

Shrink in place starting at the end nearest to the center of the splice.

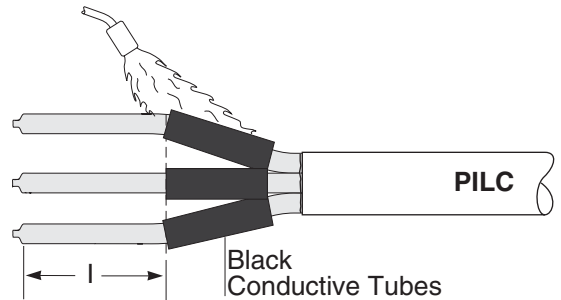

221

**11. Clean OBTs.**

Using an oil-free solvent, clean the OBT/Insulation, as shown.

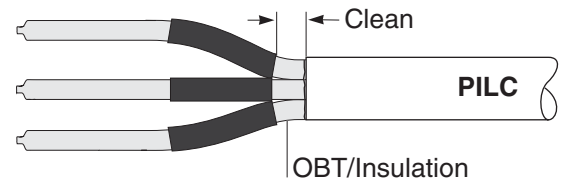

222

**12. Install SRM insert.**

Assemble SRM insert per box instructions. Spread the phases and position the insert as shown.

**Note:** The SRM insert is packaged inside the conductive breakout.

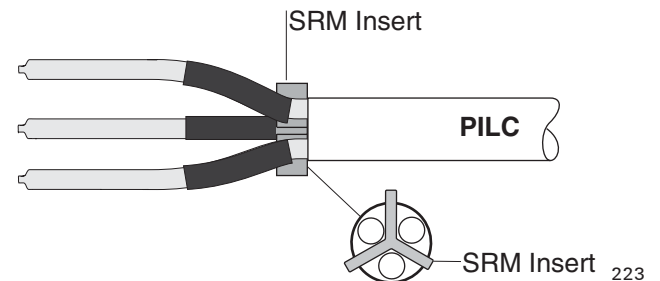

223

**13. Trim excess SRM insert.**

Trim SRM insert to extend 1/8" (3mm) beyond each phase.

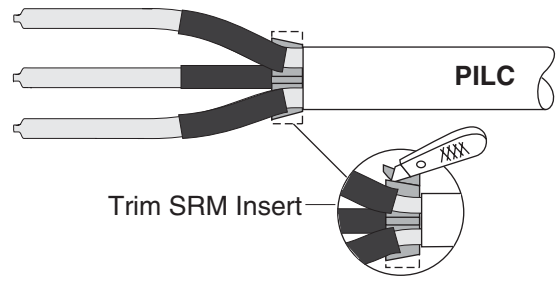

224

**14. Clean lead sheath.**

Reclean lead sheath as shown using an approved solvent

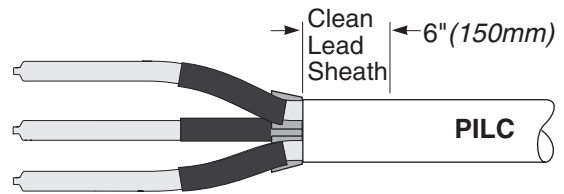

225

**15. Mark lead sheath as shown.**

**Note:** To ensure SRM to OBT adhesion, gently heat the SRM insert and adjacent OBT before moving on to the next step.

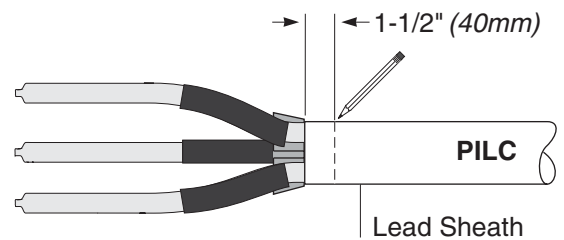

357

**16. Install oil seal.**

Remove backing from one side of a *long strip* of SRM. Roll the SRM and remaining backing strip into a convenient size. Removing the remaining backing strip, tightly wrap the SRM from the mark on the lead sheath to the outer edge of the SRM insert. Four to six strips of SRM should be used to build the SRM to the shape shown.

**Note:** Do not over apply. The finished SRM diameter should not exceed that of the breakout installed in the next step.

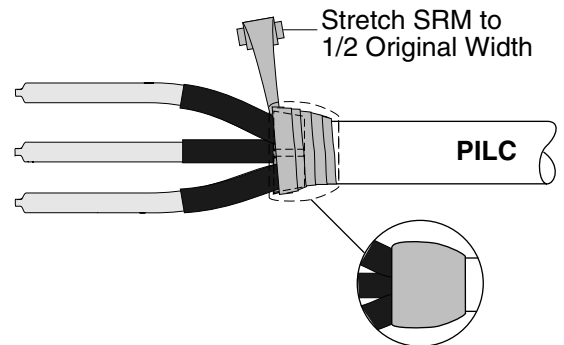

358

**17. Position conductive breakout; shrink in place.**

Position the conductive breakout over the SRM so that the inside butts up hard against the SRM.

Shrink in place starting at the fingers and working toward the other end.

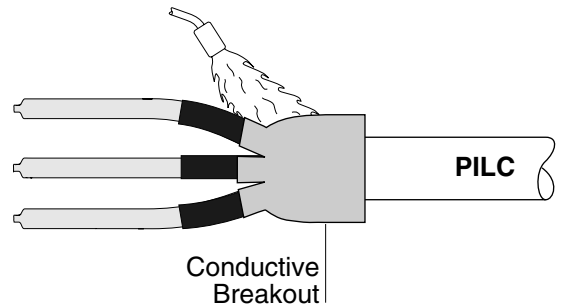

359

**18. Inspect breakout.**

After the breakout has shrunk, continue to apply heat until the breakout has a smooth, uniform surface.

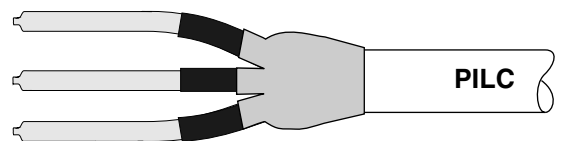

360

### 19. Position splice components.

Abrade insulation, if necessary, to remove imbedded semi-con. Clean Poly cable jackets for 30" (760mm).

Place sealing breakout over the Poly cables with the fingers pointing away from the splice center.

Place one set of nested tubes over each clean Poly cable.

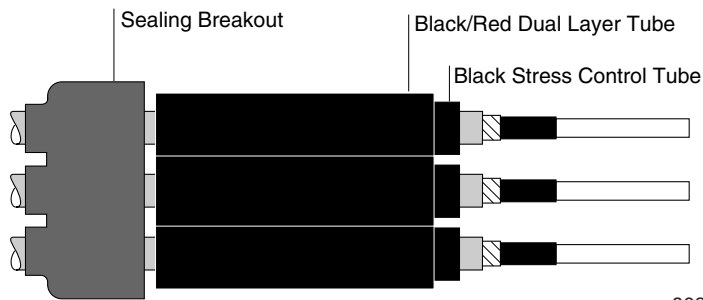

208

### 20. Remove insulation.

Refer to Table 5 and cutback the insulation as shown.

**Note:** If using Tyco Electronics CSBS ShearBolt connectors, refer to the installation instruction packaged with the connector for insulation cutback dimensions.

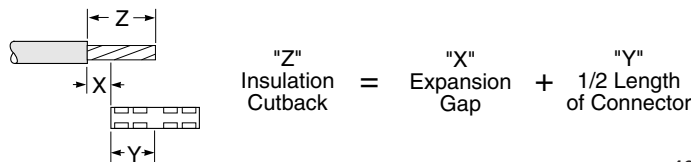

400

**Table 5: Connector Dimensions**

Kit	Max Length	Max O.D.	Expansion Gap "X"
HVS-T-1581E-S	2-1/2" (63mm)	1.00" (25mm)	1/4" (6mm)
HVS-T-1582E-S	4-1/2" (114mm)	1.40" (36mm)	1/4" (6mm)
HVS-T-1583E-S	5" (127mm)	1.85" (47mm)	1/2" (13mm)

### 21. Install connectors.

If soldering, protect OBT by wrapping it with cotton or glass fiber tape.

If crimping, make sure connector has center oil stop.

After installation, deburr connections.

**Note:** A Poly tape shield to PILC splice is shown in this instruction as an example. Any cable combination discussed earlier can be used.

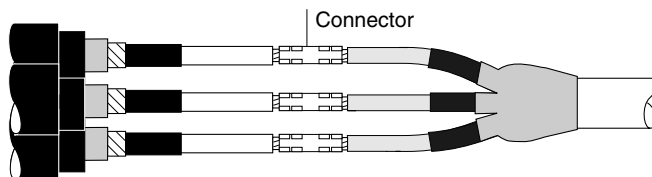

303

### 22. Clean connector area.

**Complete Steps 22-26 working on one phase at a time.**

Using an approved solvent, clean the insulation as shown, paying particular attention to the OBT/insulation surface.

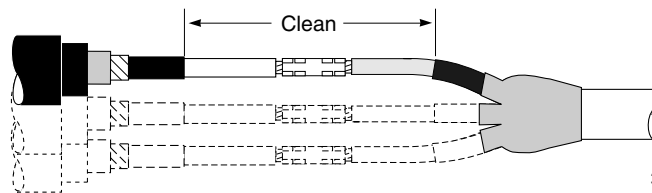

304

### 23. Apply SRM over connector.

Remove backing from one side of a *long strip* of SRM. Roll the SRM and remaining backing strip into a convenient size. Removing the remaining backing strip, tightly wrap the SRM around the connector and exposed conductor. Be sure to fill the gaps and low spots around the connector.

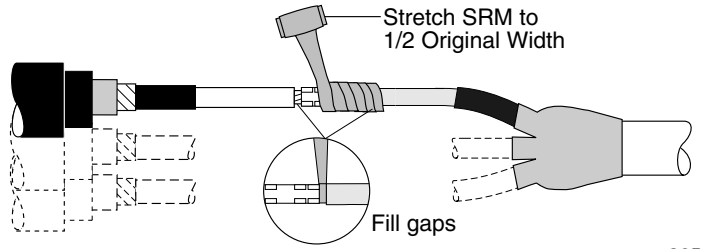

305

Continue to wrap the SRM onto the insulation as shown.

**Note:** If the connector diameter is larger than the insulation diameter, apply two half-lapped layers of SRM over the entire connector. Discard any excess SRM (long strips).

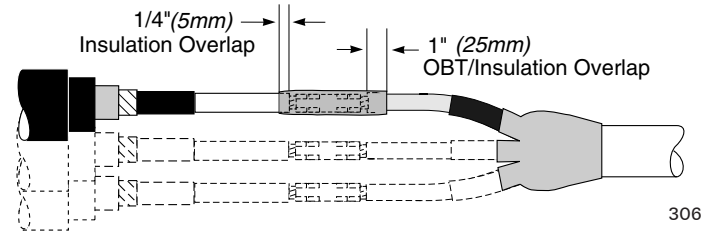

306

### 24. Apply SRM at black conductive tube step.

Remove backings from the *short angle-cut piece* of SRM. Place tip of SRM at black conductive tube step and tightly wrap to fill the step. Overlap black conductive tube and OBT/Insulation and taper down to meet OBT/Insulation as shown.

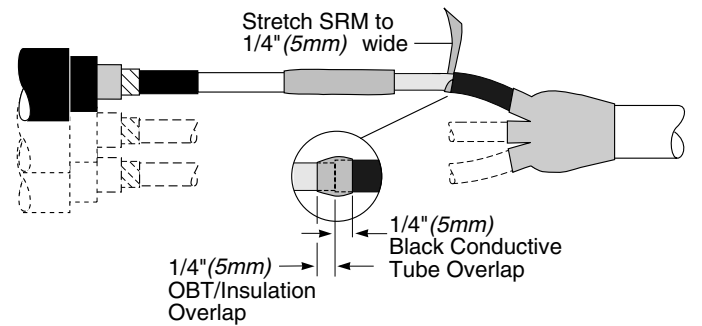

307

### 25. Apply SRM at semi-con cutback; apply Discharge Control Compound (DCC).

Remove backings from the *short angle-cut piece* of SRM. Place tip of SRM at semi-con step and tightly wrap to fill the step. Overlap semi-con and insulation and taper down to meet insulation as shown. Apply a thin film of silicon grease over the applied SRM.

**Note:** If using UniShield cable, apply SRM as shown to fill conductive jacket step.

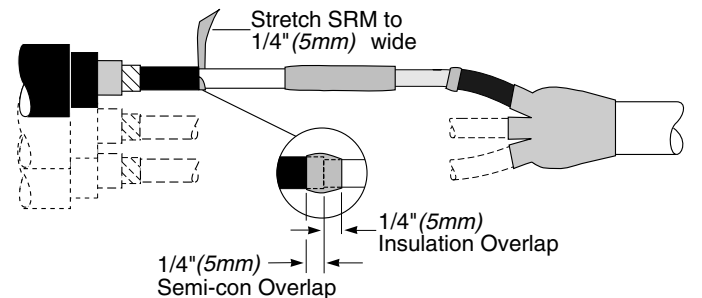

308

Snip open the end of the DCC ampule and apply a thin film of compound on the SRM over the connector and semi-con steps.

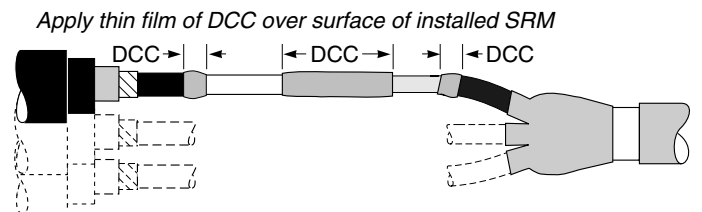

\*UniShield is a registered trademark of BICC General Cable Industries, Inc.



**26. Position black stress control tube.**

Center black stress control tube over the completed connector area. Be sure to equally overlap the Poly cable semi-con and the PILC cable black conductive tube.

Repeat Steps 22-26 for the remaining two phases.

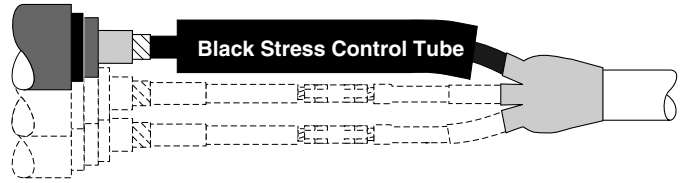

309

**27. Check position of black stress control tubes; shrink in place.**

Center the tubes over the splice. Begin shrinking at the center (1) of the tubes, working the torch around all sides of the tubes. After the center portion shrinks, work towards one end (2), then to the opposite end (3).

**Note:** Do not point the flame at the cable semi-con.

The rings from the SRM wraps may be visible as the tubing shrinks.

Post heat the connector area until the tube surface is smooth and the underlying SRM wraps are no longer visible.

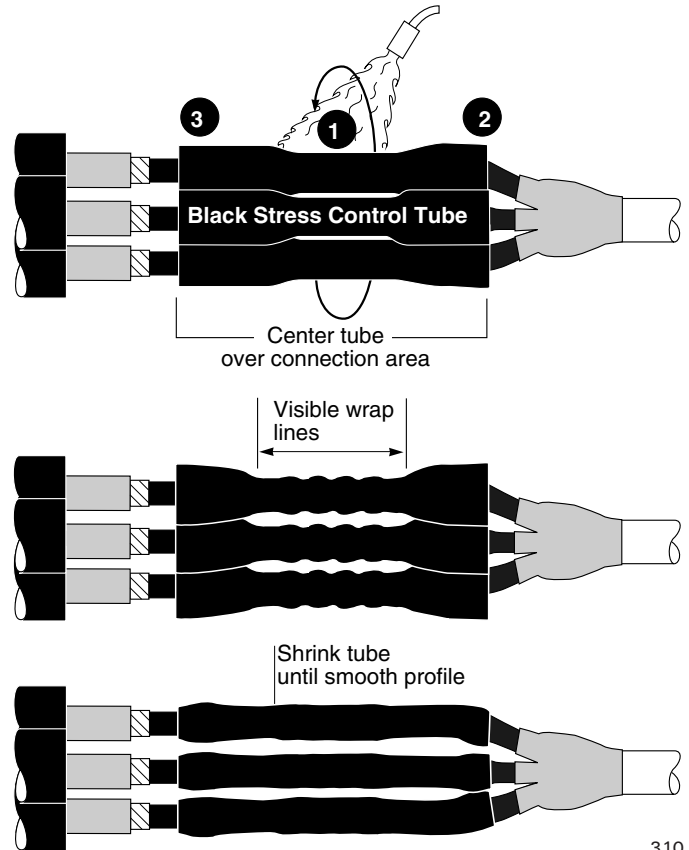

310

**28. Apply red sealant.**

Remove backing from red sealant. Using light tension, wrap one layer of red sealant over the cable, butted against the black stress control tube as shown.

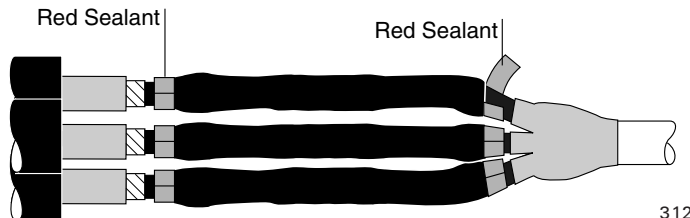

312

### 29. Position black/red dual layer tubes; shrink in place.

**Note:** Black/red dual layer tubes take longer to shrink than previous tubes.

Center tubes over joint.

(1) Begin shrinking in center of tubes, working torch around all sides of the tubes. *Pay particular attention to the back and underside of the tubes.*

(2) Before continuing, gently twist the unshrunk end of the tubes to feel for resistance to movement in center indicating the center is shrunk.

(3) Shrink from the center toward one end and stop about 5" (125mm) from the end of the tubes.

(4) Return to the center and shrink toward the other end, again stopping about 5" (125mm) from the end of the tubes.

(5) Go back to first end and shrink the remaining 5" (125mm) of tubes.

(6) Go back to second end and shrink the remaining 5" (125mm) of tubes.

(7) After completing these steps, heat the entire tubes for approximately 1 minute.

**Note:** (8) The raised ridges should disappear. Absence of ridges can be observed by visual inspection and by feeling surface with a gloved hand.

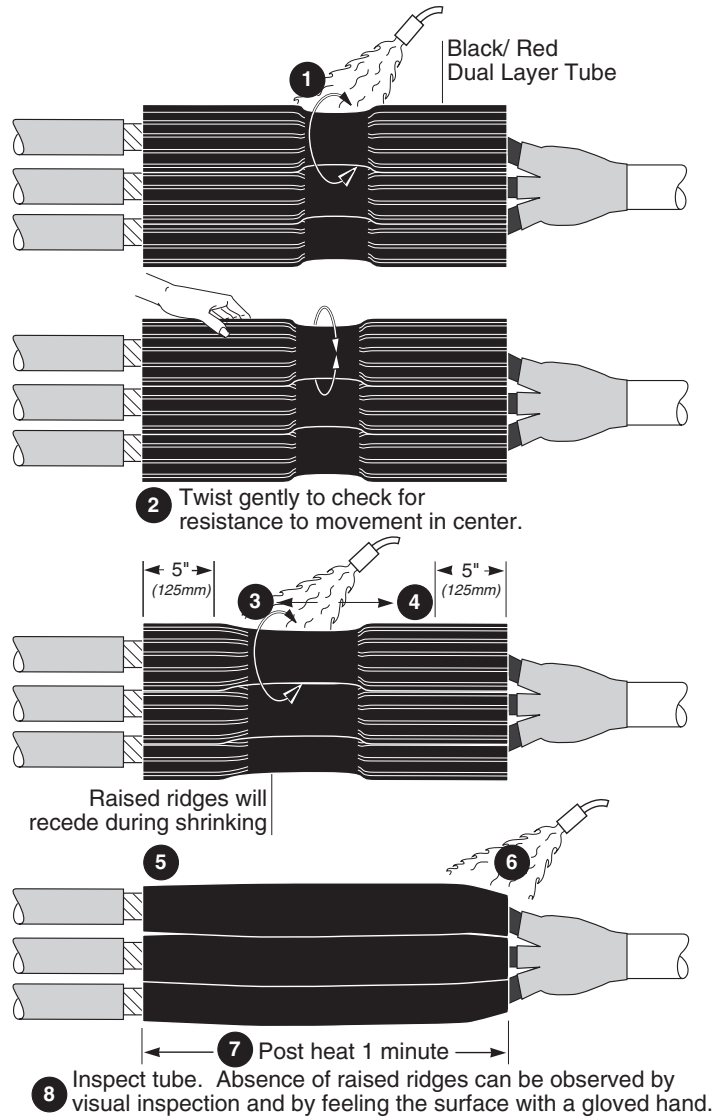

313

### 30. Install ground on single core side of splice.

Choose the appropriate cable type (Choice 1-5) and follow the directions given to ground each phase.

**Note:** Use smaller spring clamps on 1/C cables. The 2.0" spring clamp is for use on the 3/C PILC cable.

#### CHOICE 1

If Unjacketed Concentric Neutral Cable

Go to Step 1 on Page 16.

## CHOICE 2

### If Drain Wire or UniShield Cable

Pigtail the shield wires and crimp on to the ground braid using the connectors provided.

Go to Step 31.

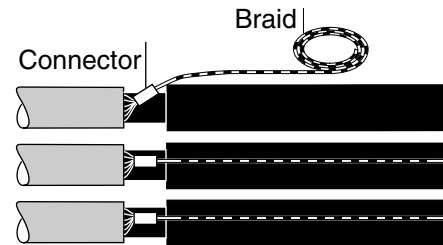

315

## CHOICE 3

### If Metallic Tape or LC Shield Cable

#### 1/C SIDE ONLY

(1) Flare one end of the ground braid and place it onto the metallic tape, butted up to the end of the tubes.  
(2) Attach the braid to the shield by placing two wraps of the SMALLER spring clamp over the braid. 3) Fold the braid back over the spring clamp wraps. Continue to wrap the remaining clamp over the braid. Tighten clamp by twisting it in the direction it is wrapped and secure with copper foil tape provided.

Repeat for remaining phases.

Discard drain wire connectors.

Go to Step 31.

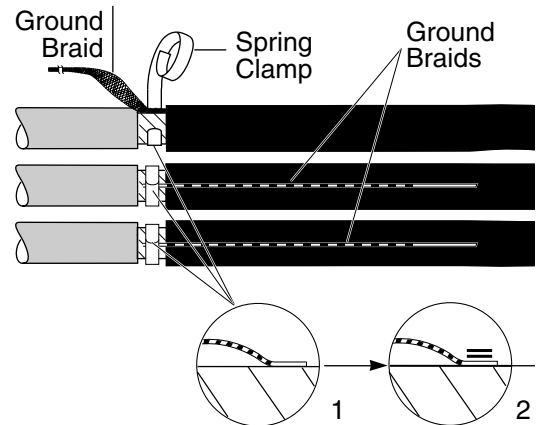

317

## CHOICE 4

### If Lead Sheath Cable

#### 1/C SIDE ONLY

Wrap three layers of 2" wide copper mesh around the lead sheath as shown. Tie off with a half-hitch.

(1) Flare one end of the ground braid and place it onto the metallic tape, butted up to the end of the tubes.  
(2) Attach the braid to the shield by placing two wraps of the spring clamp over the braid. 3) Fold the braid back over the SMALLER spring clamp wraps. Continue to wrap the remaining clamp over the braid. Tighten clamp by twisting it in the direction it is wrapped and secure with copper foil tape provided.

Repeat for remaining phases.

Go to Step 31.

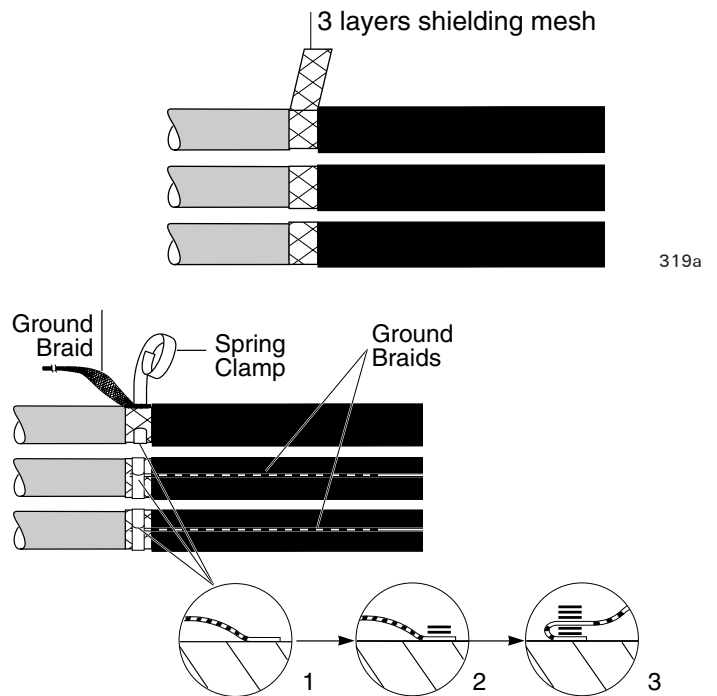

319a

319b

## CHOICE 5

### If Jacketed Concentric Neutral Cable

Pigtail the neutral wires and crimp or solder to the ground braid.

Go to Step 31.

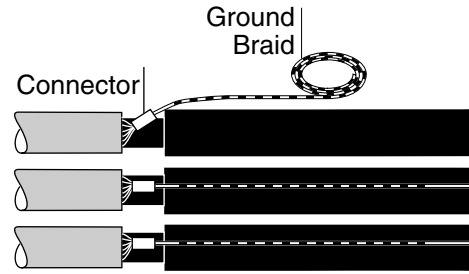

\*Not supplied in kit.

315

### 31. Install ground on 3/C PILC side of splice.

Choose the application (Choice 1-2) and follow the directions given.

## CHOICE 1

### 32. Install ground braids without external grounding

Wrap three layers of 2" wide copper mesh around the lead sheath on the 3/C side. Tie off with a half-hitch.

Lay the three braids across the joint evenly spaced around the joint circumference so that the braids overlap the mesh and temporarily tape the braids in position.

Make two wraps of the LARGE spring clamp over the braids and mesh.

Remove the temporary tape.

Fold back the overlapping braids over the spring clamp and wrap the remaining spring clamp. Tighten and secure the spring clamp. Cut off excess braids.

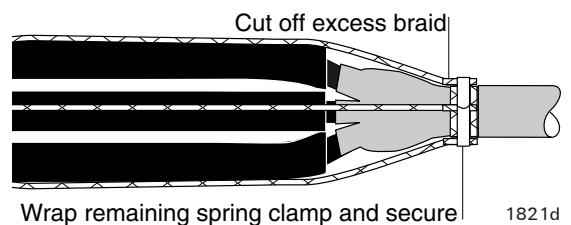
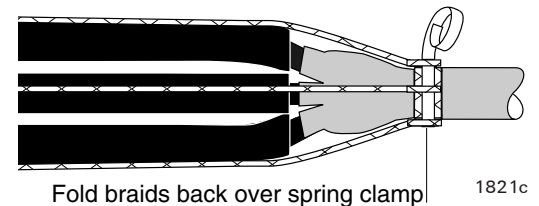
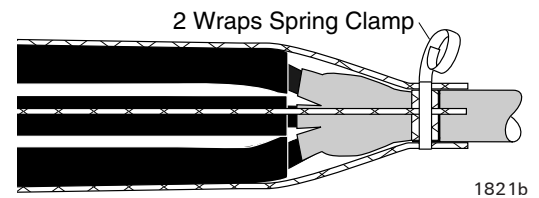
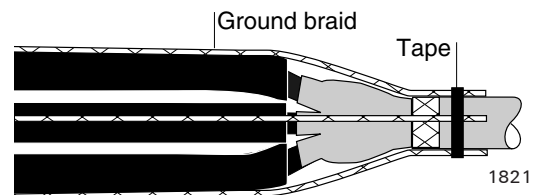
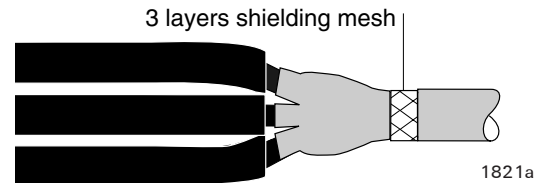

### 33. Apply shielding mesh.

Starting over the ground connections on the extruded dielectric side of the splice, wrap one half-lapped layer of 2 inch (50mm) wide shielding mesh across the splice and to the PILC cable lead sheath and tie off with a slip knot.

Abrade and solvent clean cable jackets (or lead sheath) as shown using an approved solvent.

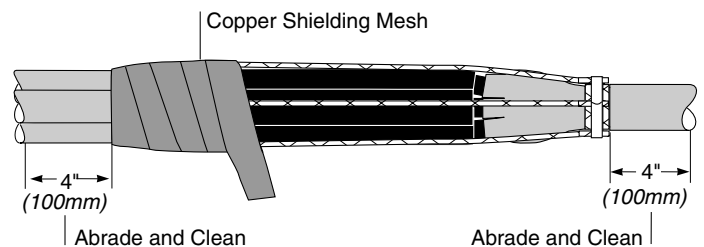

363

**34. Position non-conductive sealing breakout; shrink in place.**

Make sure that the full length of the fingers of the breakout are over the extruded dielectric cable jackets with the body extending over the splices.

Shrink in place starting at the fingers and working toward the splice center.

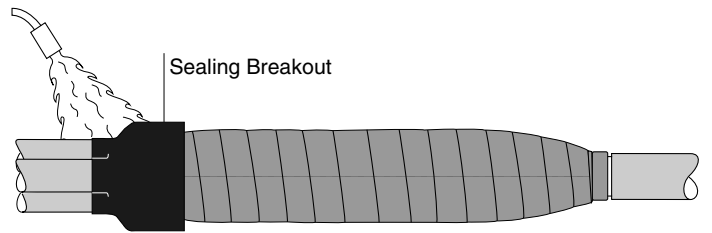

364

**35. Apply red sealant.**

Allow breakout to cool sufficiently to touch before proceeding.

Apply one wrap of red sealant over the body of the breakout as shown.

Apply one wrap of red sealant over the PILC outer sheath as shown.

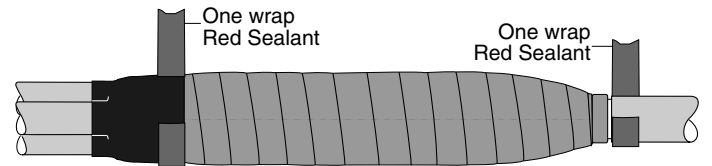

365

**Skip to Step 41.**

**CHOICE 2**

**36. Install ground braids with external grounding.**

Wrap three layers of 2" wide copper mesh around the lead sheath on 3/C side of the joint. Tie off with a half-hitch.

Lay the three braids across the joint evenly spaced around the joint circumference so that the braids overlap the mesh by about three inches on Side 1. Temporarily tape the braids in position.

Make two wraps of LARGE spring clamp over the braids and mesh on 3/C side.

Remove the temporary tape and fold back the braids back over the spring clamp towards the splice.

**Continue on next page.**

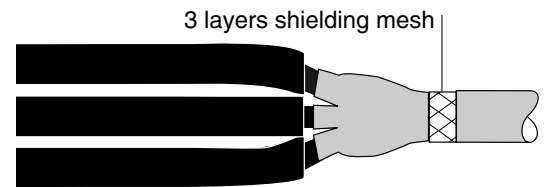

1821a

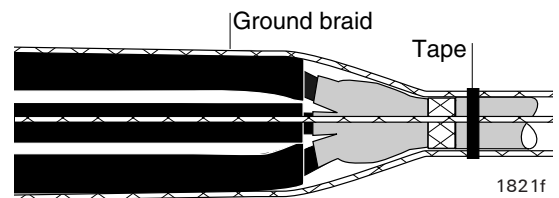

1821f

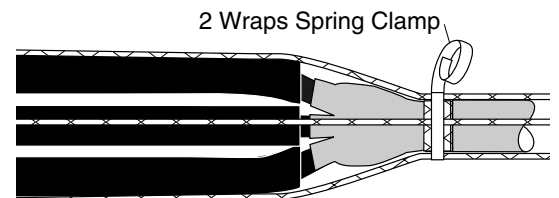

1821j

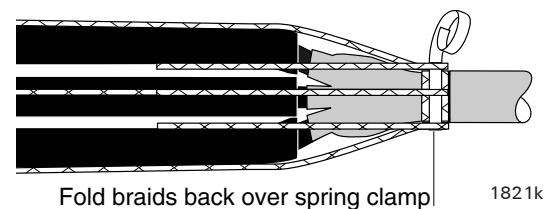

1821k

**37. Install ground clamp, solder block braids, apply sealant.**

Apply 2 more wraps of the spring clamp.

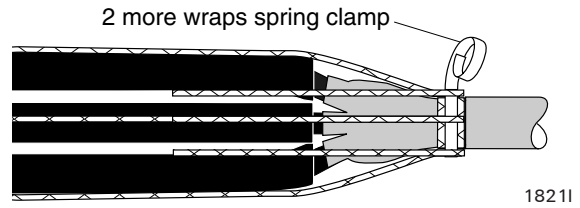

Fold back the braids back over the spring clamp and wrap the remaining spring clamp. Tighten and secure the spring clamp.

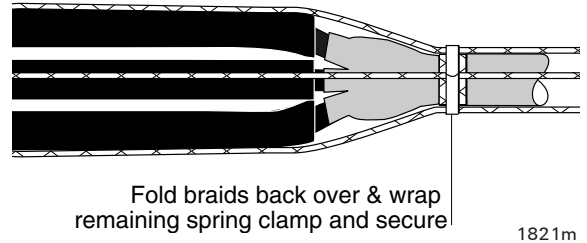

Solvent clean and abrade cable jacket for 4" as shown.

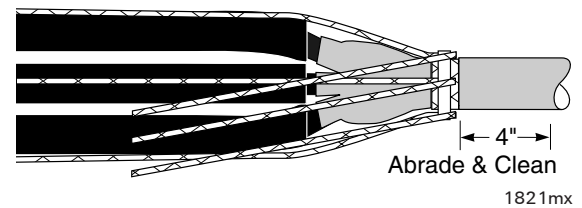

Apply one wrap of **thick** red sealant onto the cable jacket as shown.

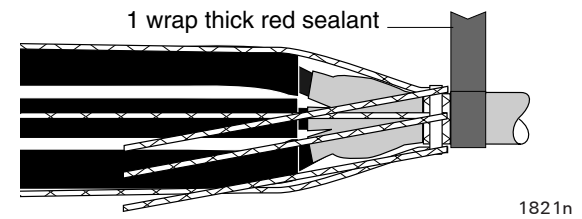

Solder block the braids where they will be pressed into the previously applied red sealant.

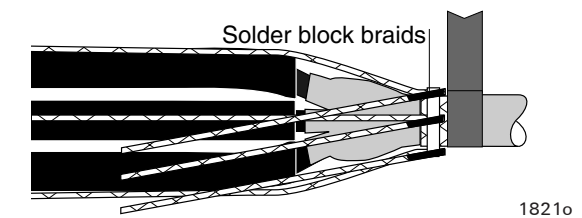

Fold the braids back over and press into the red sealant. Apply one more wrap of red sealant on top of the braids and the previously applied layer of sealant.

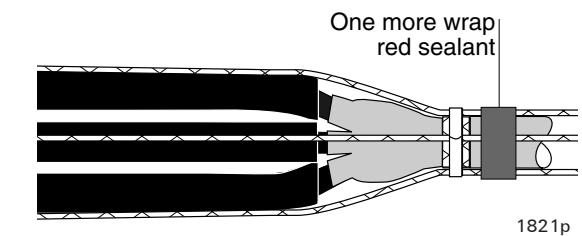

**38. Apply shielding mesh.**

Starting over the ground connections on the extruded dielectric side of the splice, wrap one half-lapped layer of 2 inch (50mm) wide shielding mesh across the splice and tie off with a slip knot to the PILC cable lead sheath.

Abrade and solvent clean cable jackets (or lead sheath) as shown using an approved solvent.

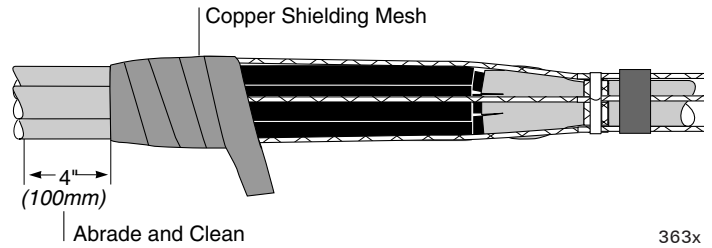

**39. Position non-conductive sealing breakout; shrink in place.**

Make sure that the full length of the fingers of the breakout are over the extruded dielectric cable jackets with the body extending over the splices.

Shrink in place starting at the fingers and working toward the splice center.

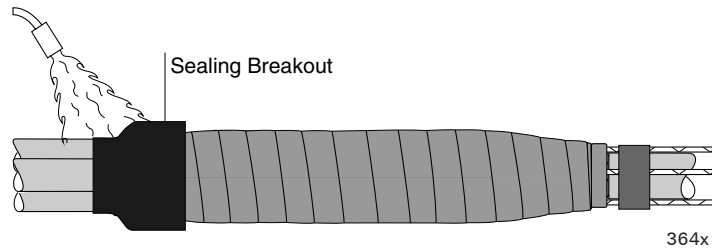

**40. Apply red sealant.**

Allow breakout to cool sufficiently to touch before proceeding.

Apply one wrap of red sealant over the body of the breakout as shown.

Continue to Step 41.

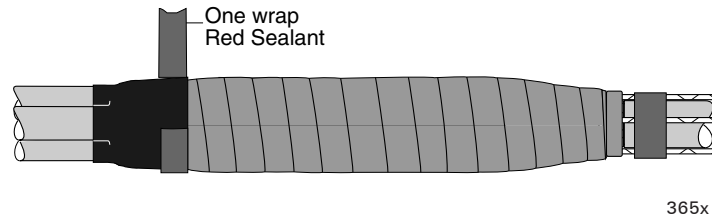

**41. Position wraparound sleeve.**

Remove or tape over all sharp points to prevent puncture of wraparound sleeve.

Remove backing from the wrap-around sealing sleeve and center sleeve over splice. Slide metal retention clip onto butted rails.

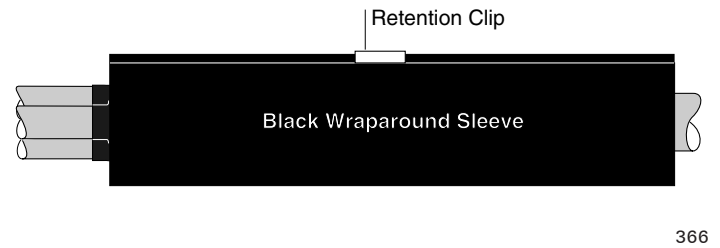

**42. Install channels.**

Slide the channels toward the center from each end of the sleeve and over the retention clip. A minimum of 1/4 inch of channel should be extended beyond the edges of the sleeve.

If channels slide on easily go to step 43. If channel fit seems tight, continue with next paragraph.

As shown in illustration A, make sure flap is not pinched between the rails. Push the sleeve up from the bottom and down from the top while sliding on channel as shown in illustration B. The idea is to flatten the rails together to prevent the channels from binding.

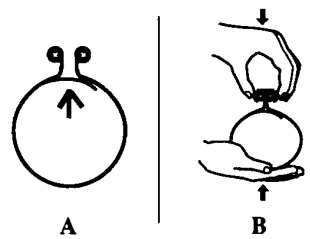
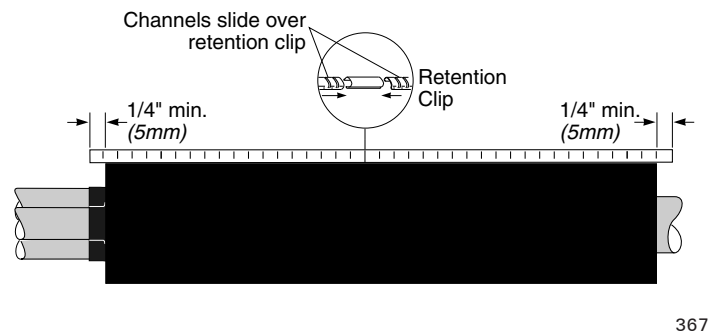

### 43. Shrink wraparound sleeve.

Preheat evenly along both sides of the rail/channel area until this area begins to shrink. To achieve uniform heating, move the flame back and forth from one side of the channel to the other as shown in illustration "A" while moving flame along the entire length of the channel as shown in illustration "B" until the sleeve starts to shrink. This technique will assure a properly preheated rail and channel area.

Begin shrinking at the center of the sleeve and work toward each end. Apply heat until the sleeve is fully shrunk and the heat-sensitive green paint is completely converted to black. Continue heating the rail/channel area for another 5 seconds per foot. A white line should be visible in the channel gaps indicating sufficient heating.

**Note: Green heat-sensitive paint will turn black as sleeve shrinks in place.**

**This completes the splice.**

**Note:** Allow to cool before moving or placing in service.

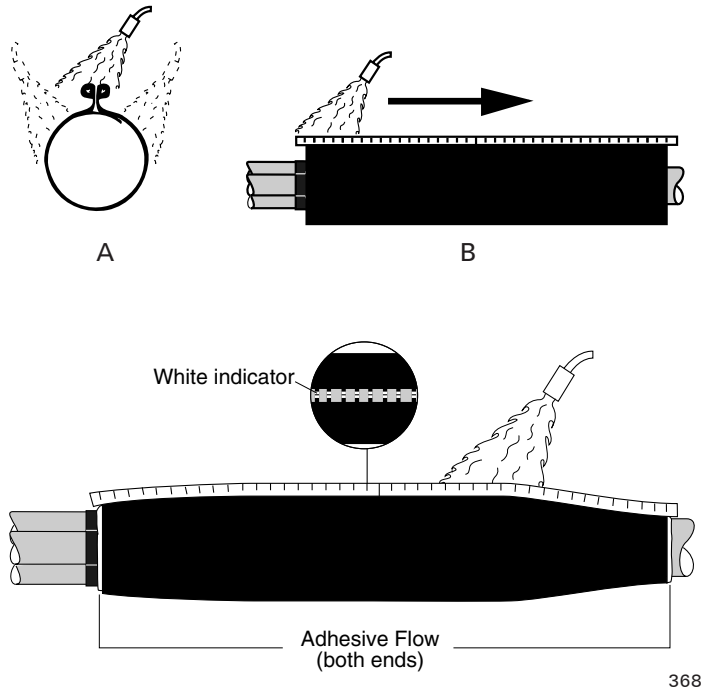

### Unjacketed Concentric Neutral Cable Only

#### 1. Apply mesh; install ground braids.

Wrap three layers of 1" wide copper mesh around the lead sheath on the 3/C side of the joint. Tie off with a half-hitch.

Make two wraps of the LARGE spring clamp over the braids and mesh.

Fold back the overlapping braids over the spring clamp and wrap the remaining spring clamp. Tighten and secure the spring clamp. Cut off excess braids.

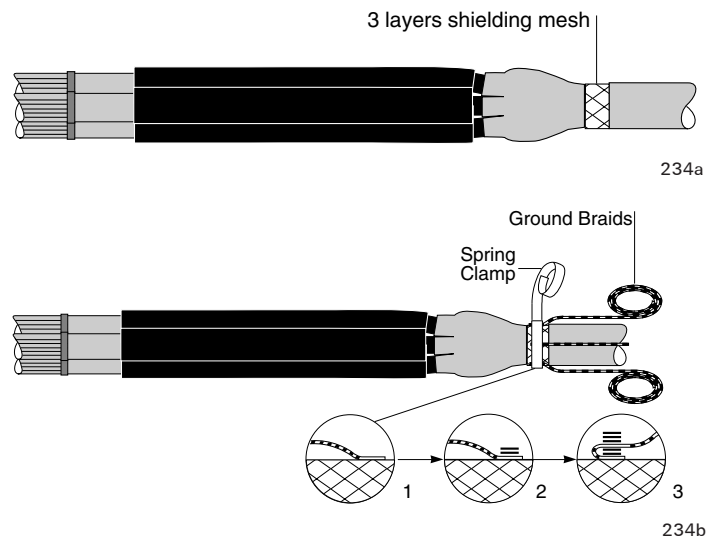

#### 2. Solder block ground braids.

To prevent the ingress of moisture, solder-block the ground braids for 2 inches (50mm) from the PILC jacket cut measurement (or equivalent measurement if unjacketed).



#### 3. Clean PILC cable jacket.

Solvent clean and abrade the cable jacket as shown.





#### 4. Apply red sealant.

Apply one layer of red sealant onto the cable jacket as shown.

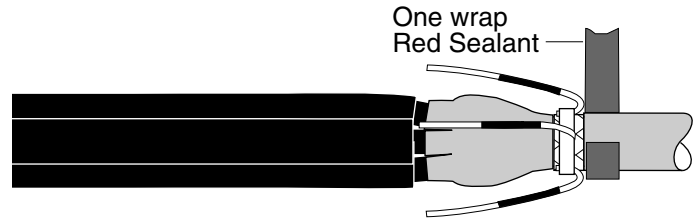

237

#### 5. Apply red sealant.

Bring the braids forward and temporarily tape them to the PILC cable to hold them in position.

Press the braids onto the sealant. Apply one layer of sealant directly over the braids and the first layer of sealant.

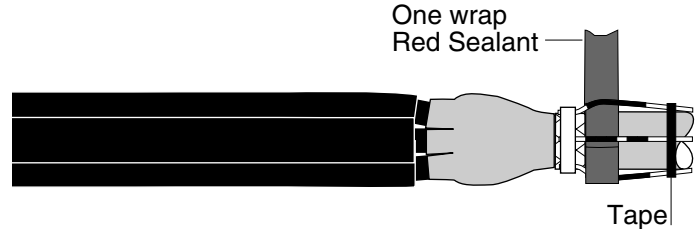

238

#### 6. Apply shield mesh.

Starting at the poly cable semi-con, wrap one half-lapped layer of 2-inch (50mm) wide shielding mesh across the splice and solder to the PILC cable lead sheath.

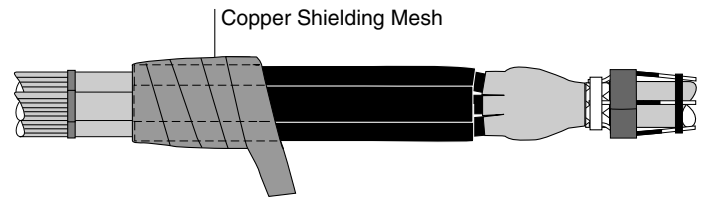

232

#### 7. Position non-conductive sealing breakout; shrink in place.

Position the breakout on the poly cable semi-con, with the fingers clear of the neutral wires and the body over the three splices.

Shrink in place starting with the fingers and working toward the splice center.

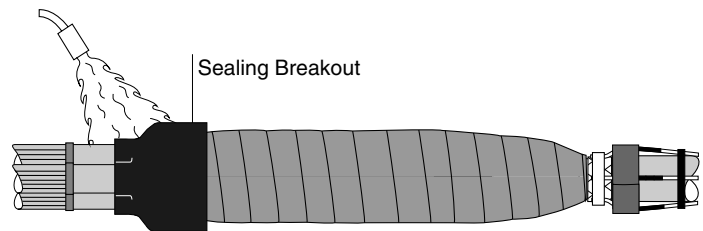

233

#### 8. Apply red sealant.

When the breakout has cooled sufficiently to touch, apply one wrap of red sealant to the body of the breakout.

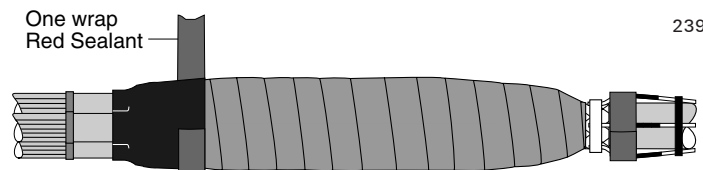

239

#### 9. Position wraparound sleeve.

Remove or tape over all sharp points to prevent puncture of wraparound sleeve. Remove backing from the wraparound sealing sleeve and center sleeve over splice. Slide metal channel onto butted rails.

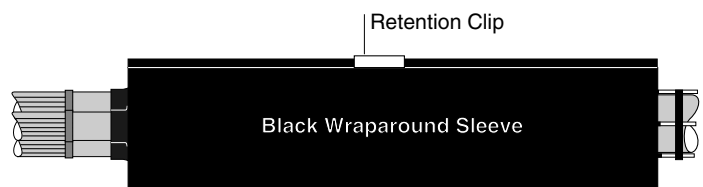

442

## 10. Install channels.

Slide the channels toward the center from each end of the sleeve and over the retention clip. A minimum of 1/4 inch of channel should be extended beyond the edges of the sleeve.

**If channels slide on easily go to step 11, page 22. If channel fit seems tight, continue with next paragraph.**

As shown in illustration A, make sure flap is not pinched between the rails. Push the sleeve up from the bottom and down from the top while sliding on channel as shown in illustration B. The idea is to flatten the rails together to prevent the channels from binding.

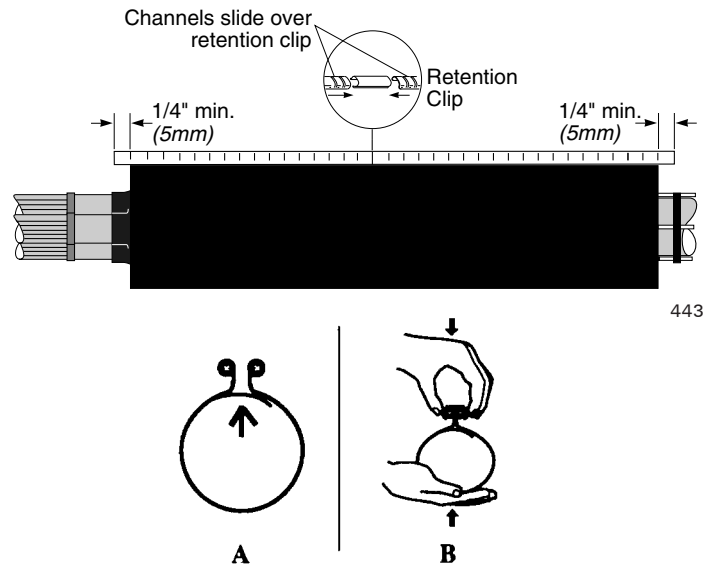

## 11. Shrink wraparound sleeve.

Preheat evenly along both sides of the rail/channel area until this area begins to shrink. To achieve uniform heating, move the flame back and forth from one side of the channel to the other as shown in illustration "A" while moving flame along the entire length of the channel as shown in illustration "B" until the sleeve starts to shrink. This technique will assure a properly preheated rail and channel area.

Begin shrinking at the center of the sleeve and work toward each end. Apply heat until the sleeve is fully shrunk and the heat-sensitive green paint is completely converted to black. Continue heating the rail/channel area for another 5 seconds per foot. A white line should be visible in the channel gaps indicating sufficient heating.

**Note: Green heat-sensitive paint will turn black as sleeve shrinks in place.**

**Note:** Allow to cool before moving or placing in service.

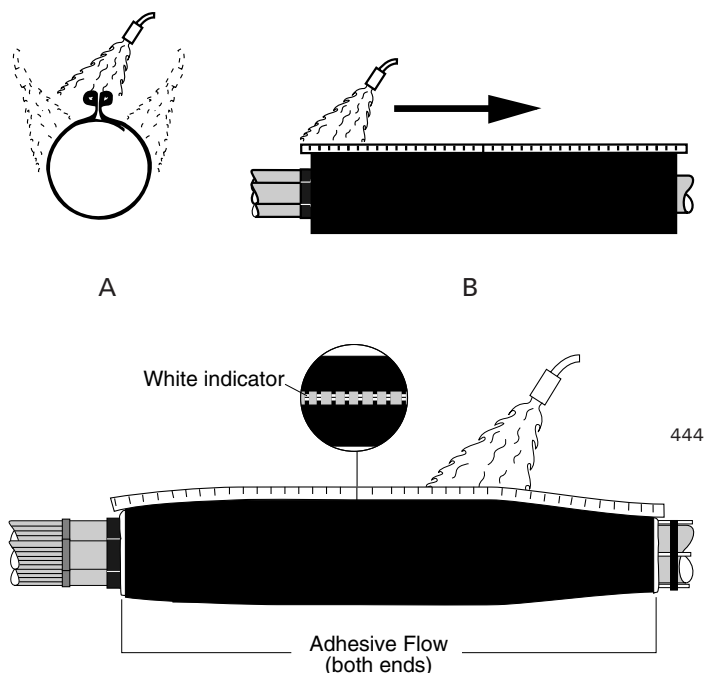

## 12. Connect ground braids.

Fold braids back over the splice and crimp or solder to the concentric neutral wires.

**This completes the splice.**

**Note:** Allow to cool before moving or placing in service.

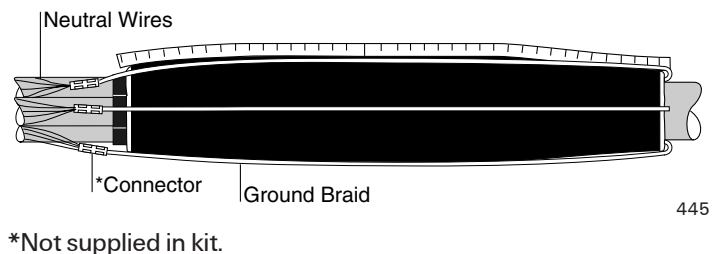

\*Not supplied in kit.

The Information contained in these installation instructions is for use only by installers trained to make electrical power installations and is intended to describe the correct method of installation for this product. However, Tyco Electronics has no control over the field conditions which influence product installation. It is the user's responsibility to determine the suitability of the installation method in the user's field conditions. Tyco Electronics' only obligations are those in Tyco Electronics' standard Conditions of Sale for this product and in no case will Tyco Electronics be liable for any other incidental, indirect or consequential damages arising from the use or misuse of the products. Raychem and ShearBolt are trade marks. Copyright 2001, 2007 Tyco Electronics Corporation, All Rights Reserved.