

1. INTRODUCTION

This specification provides a cross reference for a variety of available LEDs to all TE LUMAWISE LED holders.

The LED holders allow direct attachment of the LED to a cooling device using two customer-supplied mounting screws and provide poke-in and two-piece connector terminations to electrically connect the LED.

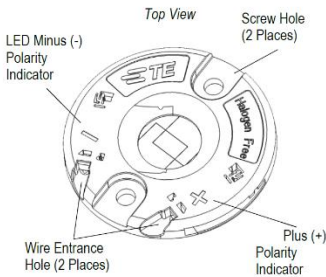

Z35 Series

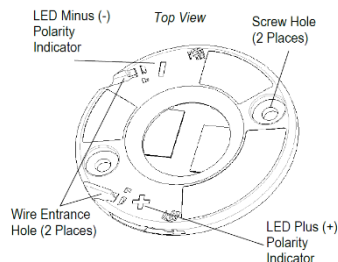

Z45 Series

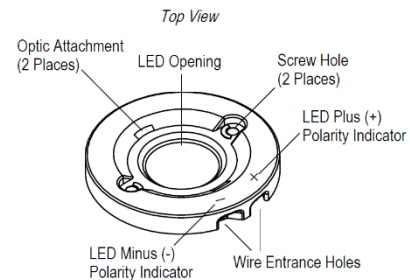

Z50 Series

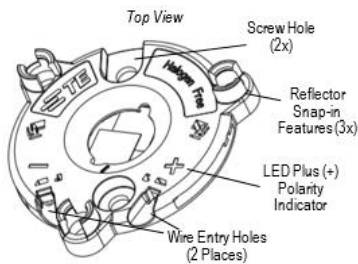

Z35L Series (2)

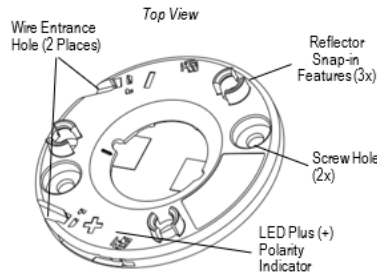

Z45L Series (3)

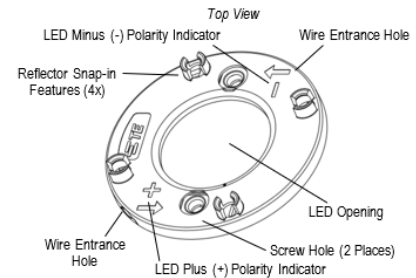

Z50L Series (4)

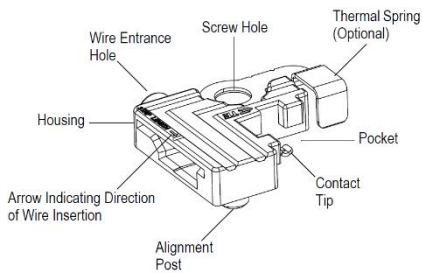

Scalable (2 req.)

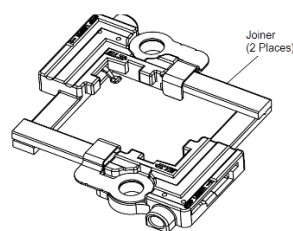

Scalable (1 pc.)

2. REFERENCE MATERIAL

2.1. Revision Summary

Revisions to this application specification include:

- Addition of COBs.

2.2. Customer Assistance

Reference Product Base Part Numbers and Product Code L836 are representative of LUMAWISE LED holders. Use of these numbers will identify the product line and help you to obtain product and tooling information. Such information can be obtained through a local Representative, by visiting our website at www.te.com, or by calling PRODUCT INFORMATION or the TOOLING ASSISTANCE CENTER at the numbers at the bottom of this page.

2.3. Drawings

Customer Drawings for product part numbers are available from the service network. If there is a conflict between the information contained in the Customer Drawings and this specification or with any other technical documentation supplied, call PRODUCT INFORMATION at the number at the bottom of this page.

2.4. Specifications

Product Specifications provide product performance and test information:

- 108-133002 TE Solderless LED Holder, Type LH
- 108-133005 Scalable LED Socket
- 108-133008 Solderless LUMAWISE Z50 Light Emitting Diode (LED) Holder
- 108-133018 LUMAWISE Z50 High Performance Light Emitting Diode (LED) Holders
- 108-133062 LUMAWISE Z35/Z45 Mini LED Holder Platform
- 108-133082 LUMAWISE Drive Z50 LED Holder

Application Specifications provide application details:

- 114-32042 Light Emitting Diode (LED) Holder (Type LH)
- 114-32043 Scalable Light Emitting Diode (LED) Socket
- 114-32048 LUMAWISE Z50 Light Emitting Diode (LED) Holder
- 114-133019 LUMAWISE Z50 High-Performance Light Emitting Diode (LED) Holders
- 114-133062 LUMAWISE Z35 Mini LED holder
- 114-133082 LUMAWISE Drive Z50 LED Holder
- 114-133107 LUMAWISE Z45 LED Holder

3. VISUAL AID

The illustration below shows a typical application of a LUMAWISE LED holder. Similar Application Specification illustrations should be used by production personnel to ensure a correctly applied product. Applications which DO NOT appear correct should be inspected using the information in the applicable Application Specifications and in the instructional material shipped with the product or tooling.

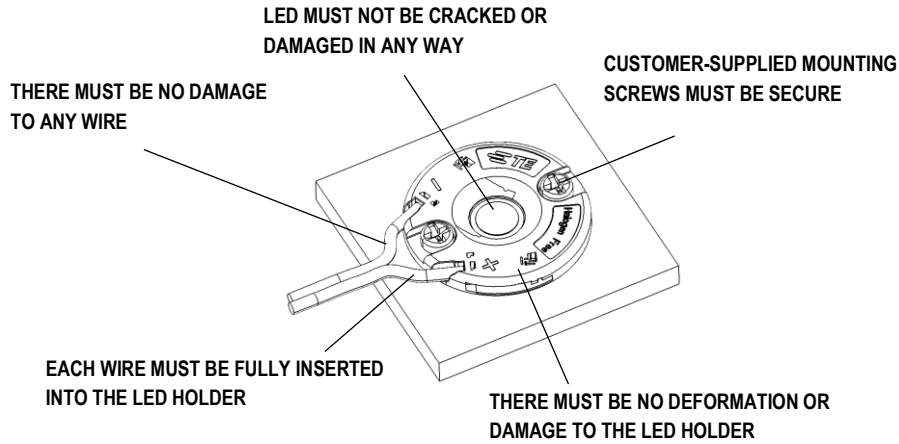

4. LED-TO-HOLDER CROSS REFERENCE

LED TYPE	LED REFERENCE DIMENSION	LUMAWISE LED HOLDER TYPE (BOLD text indicates preferred part numbers)			
		Z35	Z45	Z50	SCALABLE
BRIDGELUX DS151 VESTA 13mm ARRAY and 15mm ARRAY	20.0 X 24.0		2-2325811-1 3-2325811-1		
BRIDGELUX DS150 VESTA 9mm ARRAY	12.0 X 15.0	3-2213678-3 3-2213678-4			
BRIDGELUX H9	15.8 X 15.8				2154857-1 1-2154857-1 2-2154857-1 3-2154857-1
BRIDGELUX H15	19.0 X 19.0		2325807-3 1-2325807-3 4-2325807-3 (3)	2213254-1 2213254-2	
BRIDGELUX LS	17.5 X 13.3				1-2154857-3
BRIDGELUX V10 GEN 6	15.8 X 15.8				2-2154857-1
BRIDGELUX V10 GEN 7	13.5 X 13.5				2-2154857-2
BRIDGELUX V10C GEN 7 ARRAY	19.0 X 19.0	2213678-4 2213678-5			
BRIDGELUX V13 GEN 7 THRIVE ARRAY	19.0 X 19.0		2325807-3 1-2325807-3 4-2325807-3 (3)	2213254-1 2213254-2	
BRIDGELUX V15 GEN 6/ V15 GEN 8	21.0 X 21.0				2-2154857-1
BRIDGELUX V18 GEN 7 ARRAY	24.0 X 24.0			2213480-1 4-2213480-1 (4)	2-2154857-3
BRIDGELUX V22 GEN 7 ARRAY	28.0 X 28.0			2213480-1 4-2213480-1 (4)	

LED TYPE	LED REFERENCE DIMENSION	LUMAWISE LED HOLDER TYPE (BOLD text indicates preferred part numbers)			
		Z35	Z45	Z50	SCALABLE
CITIZEN CLL020	13.5 X 13.5	2213678-5 2213678-6 4-2213678-5 (2)			2-2154857-1 (2 PC) 6-2154874-1 (1 PC)
CITIZEN CLL022	13.5 X 13.5	2213678-5 2213678-6 4-2213678-5 (2)			2-2154857-1 (2 PC) 6-2154874-1 (1 PC)
CITIZEN CLL030	19.0 X 19.0		2325807-3 1-2325807-3 4-2325807-3 (3)	2213254-1 2213254-2	2-2154857-1 (2 PC) 6-2154874-2 (1 PC)
CITIZEN CLL032	19.0 X 19.0		2325807-3 1-2325807-3 4-2325807-3 (3)	2213254-1 2213254-2	2-2154857-1 (2 PC) 6-2154874-2 (1 PC)
CITIZEN CLL040	28.0 X 28.0			2213480-1 4-2213480-1 (4)	2-2154857-2 (2 PC) 6-2154874-3 (1 PC)
CITIZEN CLL042	28.0 X 28.0			2213480-1 4-2213480-1 (4)	2-2154857-2 (2 PC) 6-2154874-3 (1 PC)
CITIZEN CLL050	38.0 X 38.0				2-2154857-2 (2 PC) 6-2154874-4 (1 PC)
CITIZEN CLL052	38.0 X 38.0				2-2154857-2 (2 PC) 6-2154874-4 (1 PC)
CITIZEN CLL036-1205C1	19.0 X 19.0			2213254-1 2213254-2	
CITIZEN CLL036-1206C1	19.0 X 19.0			2213254-1 2213254-2	
CITIZEN CLL036-1208C1, REF. CE-P3080 04/15	19.0 X 19.0			2213254-1 2213254-2	
CITIZEN CLU024	13.5 X 13.5	2213678-5 2213678-6 4-2213678-5 (2)			
CITIZEN CLU025	13.5 X 13.5	2213678-5 2213678-6 4-2213678-5 (2)			
CITIZEN CLU026	13.5 X 13.5	2213678-5 2213678-6 4-2213678-5 (2)			
CITIZEN CLU027	13.5 X 13.5	2213678-5 2213678-6 4-2213678-5 (2)			
CITIZEN CLU028	13.5 X 13.5	2213678-5 2213678-6 4-2213678-5 (2)			
CITIZEN CLU034	19.0 X 19.0		2325807-3 1-2325807-3 4-2325807-3 (3)	2213254-1 2213254-2	
CITIZEN CLU036	19.0 X 19.0		2325807-3 1-2325807-3 4-2325807-3 (3)	2213254-1 2213254-2	
CITIZEN CLU038	19.0 X 19.0		2325807-3 1-2325807-3 4-2325807-3 (3)		
CITIZEN CLU038-1206C4	19.0 X 19.0			2213254-1 2213254-2	
CITIZEN CLU044	27.6 X 28.0			2213480-1 4-2213480-1 (4)	
CITIZEN CLU046	27.6 X 28.0			2213480-1 4-2213480-1 (4)	
CITIZEN CLU048	28.0 X 28.0			2213480-1 4-2213480-1 (4)	
CITIZEN CLU048-1212C4	28.0 X 28.0			2213480-1 4-2213480-1 (4)	
CITIZEN CLU700	13.5 X 13.5	2213678-5 2213678-6 4-2213678-5 (2)			
CITIZEN CLU701	13.5 X 13.5	2213678-5 2213678-6 4-2213678-5 (2)			
CITIZEN CLU710	19.0 X 19.0		2325807-2 1-2325807-2 4-2325807-2 (3)		

LED TYPE	LED REFERENCE DIMENSION	LUMAWISE LED HOLDER TYPE (BOLD text indicates preferred part numbers)			
		Z35	Z45	Z50	SCALABLE
CITIZEN CLU710-1204C1	19.0 X 19.0	2213929-7 2213929-8 1-2213929-7 1-2213929-8			
CITIZEN CLU711	19.0 X 19.0		2325807-2 1-2325807-2 4-2325807-2 (3)		
CITIZEN CLU711-1204C1	19.0 X 19.0	2213929-7 2213929-8 1-2213929-7 1-2213929-8			
CITIZEN CLU720	19.0 X 19.0		2325807-3 1-2325807-3 4-2325807-3 (3)	2213254-1 2213254-2	
CITIZEN CLU721	19.0 X 19.0		2325807-3 1-2325807-3 4-2325807-3 (3)		
CITIZEN CLU721-1206C1	19.0 X 19.0	2213929-3 2213929-4 1-2213929-3 1-2213829-4			
CITIZEN CLU730	27.6 X 28.0			2213480-1 4-2213480-1 (4)	
CITIZEN CLU731	28.0 X 28.0			2213480-1 4-2213480-1 (4)	
CITIZEN L330	28.0 X 19.0				2-2154857-3
CITIZEN L340	28.5 X 28.5				2-2154857-3

CREE CMA 1825	17.85 X 17.85			2213401-1 2213401-2	
CREE CMA 3090	27.35 X 27.35			2213480-2	2-2154857-2
CREE CMT 1420	13.5 X 13.5	2213678-5 2213678-6 4-2213678-5 (2)			
CREE CMT 1922	19.0 X 19.0		2325807-3 1-2325807-3 4-2325807-3 (3)	2213254-1 2213254-2	
CREE CMT 1925	19.0 X 19.0		2325807-3 1-2325807-3 4-2325807-3 (3)	2213254-1 2213254-2	
CREE CMT 1930	19.0 X 19.0		2325807-3 1-2325807-3 4-2325807-3 (3)	2213254-1 2213254-2	
CREE CMT 2890	27.6 X 28.0			2213480-1 4-2213480-1 (4)	
CREE CMU 2236	28.0 X 28.0			2213480-1 4-2213480-1	2-2154857-2
CREE CXA 2011	22.0 X 22.0				1-2154857-3 (2 PC) 5-2154874-1 (1 PC)
CREE CXA13XX/CXB13XX	13.35 X 13.35				2-2154857-2
CREE CXA15XX/CXB15XX	15.85 X 15.85				2-2154857-2 (2 PC) 5-2154874-2 (1 PC)
CREE CXA1812	17.85 X 17.85			2213401-1 2213401-2	
CREE CXA1816	17.85 X 17.85				2-2154857-2
CREE CXA1820	17.85 X 17.85			2213401-1 2213401-2	2-2154857-1
CREE CXA1830	17.85 X 17.85				2-2154857-1
CREE CXA 25XX/CXB25XX	23.85 X 23.85			2213407-1 2213407-2	2-2154857-2 (2 PC) 5-2154874-3 (1 PC)
CREE CXA 30XX	27.35 X 27.35				2-2154857-2
CREE CXB 1310	13.5 X 13.5				2-2154857-2

LED TYPE	LED REFERENCE DIMENSION	LUMAWISE LED HOLDER TYPE (BOLD text indicates preferred part numbers)			
		Z35	Z45	Z50	SCALABLE
CREE CXB 1816	17.85 X 17.85				2-2154857-2
CREE CXB 1820	17.85 X 17.85			2213401-1 2213401-2	2-2154857-1
CREE CXB 1830	17.85 X 17.85				2-2154857-1
CREE CXB 2540	23.85 X 23.85			2213407-1 2213407-2	
CREE CXB 3070	27.35 X 27.35				2-2154857-2
CREE CXB 3590	34.85 X 34.85				2-2154857-3

EDISON-OPTO HE CR180 SERIES	19.0 X 19.0		2325807-3 1-2325807-3 4-2325807-3 (3)		
EDISON-OPTO HE CR190 SERIES	19.0 X 19.0		2325807-3 1-2325807-3 4-2325807-3 (3)		
EDISON-OPTO HM CR180 SERIES	19.0 X 19.0		2325807-3 1-2325807-3 4-2325807-3 (3)		
EDISON-OPTO HM CR190 SERIES	19.0 X 19.0		2325807-3 1-2325807-3 4-2325807-3 (3)		
EDISON-OPTO SL SERIES	19.0 X 19.0		2325807-3 1-2325807-3 4-2325807-3 (3)		
EDISON-OPTO 2PHM09X	13.5 X 13.5	2213678-5 2213678-6 4-2213678-5 (2)			2-2154857-1 (2 PC) 6-2154874-1 (1 PC)
EDISON-OPTO 2PHM30X	19.0 X 19.0				2-2154857-1 (2 PC) 6-2154874-2 (1 PC)
EDISON-OPTO 2PHM30XWXP13001	19.0 X 19.0			2213254-1 2213254-2	
EDISON-OPTO 2PHM40X	27.6 X 28.0			2213480-1	
EVERLIGHT EAHP1919	19.0 X 19.0		2325807-2 1-2325807-2 4-2325807-2 (3)	2213254-1 2213254-2	
EVERLIGHT EAHP2024	20.0 X 24.0		2325811-2 1-2325811-2 4-2325811-2 (3)		
EVERLIGHT JU1215	12.0 X 15.0	2213678-3 2213678-4 4-2213678-3 (2)			
EVERLIGHT XUAN1313	13.5 X 13.5				2-2154857-1 (2 PC) 6-2154874-2 (1 PC)
EVERLIGHT XUAN1919	19.0 X 19.0			2213254-1 2213254-2	

LEXTAR NIMBUS 1500	19.0 X 19.0			2213254-1 2213254-2	
LEXTAR PB16H	19.0 X 19.0		2325807-3 1-2325807-3 4-2325807-3 (3)		
LEXTAR PB16U	19.0 X 19.0		2325807-3 1-2325807-3 4-2325807-3 (3)		
LEXTAR PB19H	19.0 X 19.0		2325807-3 1-2325807-3 4-2325807-3 (3)		
LEXTAR PB19U	19.0 X 19.0		2325807-3 1-2325807-3 4-2325807-3 (3)		

LED TYPE	LED REFERENCE DIMENSION	LUMAWISE LED HOLDER TYPE (BOLD text indicates preferred part numbers)			
		Z35	Z45	Z50	SCALABLE
LEXTAR PB26H	19.0 X 19.0		2325807-3 1-2325807-3 4-2325807-3 (3)		
LEXTAR PB26U	19.0 X 19.0		2325807-3 1-2325807-3 4-2325807-3 (3)		
LG INNOTEK 10, 13, 17, 24W LEMWM	24.4 X 18.0				2-2154857-2
LG INNOTEK LEMWM28C80HZXXX	27.6 X 28.0			2213480-1 4-2213480-1 (4)	
LG INNOTEK LEMWM28C80LZXXX	27.6 X 28.0			2213480-1 4-2213480-1 (4)	

LUMILEDS LUXEON 105	12.0 X 15.0	2213678-3 2213678-4 4-2213678-3 (2)			
LUMILEDS LUXEON 107	12.0 X 15.0	2213678-3 2213678-4 4-2213678-3 (2)			
LUMILEDS LUXEON 109	12.0 X 15.0	2213678-3 2213678-4 4-2213678-3 (2)			
LUMILEDS 1202 GEN 1 / GEN 3	16.0 X 19.0			2213382-1 2213382-2	
LUMILEDS 1202 CRSP	16.0 X 19.0			2213382-1 2213382-2	
LUMILEDS 1202s	12.0 X 15.0	2213678-3 4-2213678-3 (2)			
LUMILEDS 1203 GEN 1 / GEN 3	16.0 X 19.0			2213382-1 2213382-2	2-2154857-2
LUMILEDS 1203 CRSP	16.0 X 19.0			2213382-1 2213382-2	2-2154857-2
LUMILEDS 1204 GEN 1 / GEN 3	20.0 X 24.0		2325811-2 1-2325811-2 4-2325811-2 (3)	2213130-1 2213130-2	2-2154857-3
LUMILEDS 1204 CRSP	20.0 X 24.0		2325811-2 1-2325811-2 4-2325811-2 (3)	2213130-1 2213130-2	2-2154857-3
LUMILEDS 1205 GEN 1 / GEN 3	20.0 X 24.0		2325811-2 1-2325811-2 4-2325811-2 (3)	2213130-1 2213130-2	2-2154857-3
LUMILEDS 1205 CRSP	20.0 X 24.0		2325811-2 1-2325811-2 4-2325811-2 (3)	2213130-1 2213130-2	2-2154857-3
LUMILEDS 1208 GEN 1 / GEN 3	20.0 X 24.0		2325811-2 1-2325811-2 4-2325811-2 (3)	2213130-1 2213130-2	2-2154857-3
LUMILEDS 1208 CRSP	20.0 X 24.0		2325811-2 1-2325811-2 4-2325811-2 (3)	2213130-1 2213130-2	2-2154857-3
LUMILEDS 1211	28.0 X 28.0			2213480-1 4-2213480-1 (4)	
LUMILEDS 1216	28.0 X 28.0			2213480-1 4-2213480-1 (4)	
LUMILEDS L2C5-XXXX1202E0900	16.0 X 19.0	2213929-5 1-2213929-5 2213929-6 1-2213929-6			
LUMILEDS L2C5-XXXX1203E0900	16.0 X 19.0	2213929-5 1-2213929-5 2213929-6 1-2213929-6			

LED TYPE	LED REFERENCE DIMENSION	LUMAWISE LED HOLDER TYPE (BOLD text indicates preferred part numbers)			
		Z35	Z45	Z50	SCALABLE
LUMINUS CGM-14 GEN 4	19.0 X 19.0		2325807-2 1-2325807-2 4-2325807-2 (3)	2213254-1 2213254-2	2154857-1
LUMINUS CGM-22 GEN 4	28.0 X 28.0			2213480-1 4-2213480-1 (4)	
LUMINUS CHM-6-XH20	13.5 X 13.5	2213678-5 2213678-6 4-2213678-5 (2)			2154857-1
LUMINUS CHM-6-XH30	13.5 X 13.5	2213678-5 2213678-6 4-2213678-5 (2)			2154857-1
LUMINUS CHM-9-AC00	13.5 X 13.5	2213678-5 2213678-6 4-2213678-5 (2)		2213254-1 2213254-2	
LUMINUS CHM-9-XD20	15.0 X 15.0				2-2154857-2
LUMINUS CHM-9-XH20	19.0 X 19.0		2325807-2 1-2325807-2 4-2325807-2 (3)	2213254-1 2213254-2	2154857-1
LUMINUS CHM-9-XH30	19.0 X 19.0		2325807-2 1-2325807-2 4-2325807-2 (3)	2213254-1 2213254-2	2154857-1
LUMINUS CHM-11-XH20	19.0 X 19.0		2325807-2 1-2325807-2 4-2325807-2 (3)	2213254-1 2213254-2	2154857-1
LUMINUS CHM-11	19.0 X 19.0	2213929-3 1-2213929-3			
LUMINUS CHM-14-AC00	19.0 X 19.0		2325807-3 1-2325807-3 4-2325807-3 (3)		
LUMINUS CHM-14-AC10	19.0 X 19.0		2325807-3 1-2325807-3 4-2325807-3 (3)		
LUMINUS CHM-14-XH20	28.0 X 28.0			2213480-1 4-2213480-1 (4)	
LUMINUS CLM-9 GEN 3 / GEN 4	13.5 X 13.5	2213678-5 2213678-6 4-2213678-5 (2)			2154857-1
LUMINUS CLM-14 GEN 3	18.5 x 18.5				2154857-2
LUMINUS CLM-14 GEN 3 / GEN 4	19.0 X 19.0		2325807-3 1-2325807-3 4-2325807-3 (3)	2213254-1 2213254-2	2154857-1
LUMINUS CLM-22 GEN 4	28.0 X 28.0			2213480-1 4-2213480-1 (4)	
LUMINUS CVM-32 GEN 4	38.0 X 38.0				2-2154857-2
LUMINUS CXM-4 GEN4	13.5 X 13.5	2213678-5 2213678-6 4-2213678-5 (2)			2154857-1
LUMINUS CXM-6 GEN 3	12.0 X 13.0				2-2154857-2
LUMINUS CXM-6 GEN 3 / GEN 4	13.5 X 13.5	2213678-5 2213678-6 4-2213678-5 (2)			2154857-1
LUMINUS CXM-9 GEN 3 / GEN 4	13.5 X 13.5	2213678-5 2213678-6 4-2213678-5 (2)			
LUMINUS CXM-9 GEN 4	15.0 X 15.0				2-2154857-2
LUMINUS CXM-11 GEN 3 / GEN 4	19.0 X 19.0	2213929-3 1-2213929-3	2325807-2 1-2325807-2 4-2325807-2 (3)		2-2154857-2

LED TYPE	LED REFERENCE DIMENSION	LUMAWISE LED HOLDER TYPE (BOLD text indicates preferred part numbers)			
		Z35	Z45	Z50	SCALABLE
LUMINUS CXM-11-AC00	19.0 X 19.0		2325807-3 1-2325807-3 4-2325807-3 (3)	2213254-1 2213254-2	
LUMINUS CXM-11-XH00	19.0 X 19.0		2325807-3 1-2325807-3 4-2325807-3 (3)		
LUMINUS CXM-14 GEN 3 / GEN 4	19.0 X 19.0		2325807-2 1-2325807-2 4-2325807-2 (3)	2213254-1 2213254-2	2-2154857-2
LUMINUS CXM-18 GEN 3 / GEN 4	21.5 X 21.5				2-2154857-2
LUMINUS CXM-22 GEN 3 / GEN 4	28.0 X 28.0			2213480-1 4-2213480-1 (4)	
LUMINUS CXM-27 GEN 3	31.5 X 31.5				2154857-3
LUMINUS CXM-32 GEN 3 / GEN 4	38.0 X 38.0				2-2154857-2

NICHIA L036A	19.0 X 16.0			2213382-1 2213382-2	2-2154857-1
NICHIA L066	19.0 X 16.0			2213382-1 2213382-2	2-2154857-1
NICHIA L121A	19.0 X 16.0			2213382-1 2213382-2	2-2154857-1
NICHIA COB -J360	24.0 X 19.0				2-2154857-1
NICHIA S SERIES		2213678-3 2213678-4 4-2213678-3 (2)			
NICHIA NFCLJ108B	24.0 X 19.0			2213580-1 2213580-2	
NICHIA NFCLL060B-V1	16.0 X 19.0	2213929-5 1-2213929-5 2213929-6 1-2213929-6			
NICHIA NFCWJ108B	24.0 X 19.0			2213580-1 2213580-2	
NICHIA NFCWL036B-V1M3	16.0 X 19.0	2213929-5 1-2213929-5 2213929-6 1-2213929-6			
NICHIA NFDLJ130B	24.0 X 19.0			2213580-1 2213580-2	
NICHIA NFDWJ130B	24.0 X 19.0			2213580-1 2213580-2	
NICHIA NFDWJ130B-V2	24.0 X 19.0			2213580-1 2213580-2	
NICHIA NFCWL060B-V1;	16.0 X 19.0	2213929-5 1-2213929-5 2213929-6 1-2213929-6			
NICHIA NTCWS024B-V3	12.0 X 15.0	2213678-3 2213678-4			
NICHIA NVCWL024Z	16.0 X 19.0	2213929-5 1-2213929-5 2213929-6 1-2213929-6			

OSRAM GW KAJ	30.0 X 30.0				3-2154857-3
OSRAM S13	19.0 X 19.0		2325807-2 1-2325807-2 4-2325807-2 (3)		
OSRAM S13 2nd GEN	19.0 X 19.0			2213254-1 2213254-2	

LED TYPE	LED REFERENCE DIMENSION	LUMAWISE LED HOLDER TYPE (BOLD text indicates preferred part numbers)			
		Z35	Z45	Z50	SCALABLE
OSRAM S19	23.85 X 23.85			2213407-1	
OSRAM S19 GW KAHLB2.PM	24.0 X 24.0			2213407-1 2213407-2	
PANASONIC C14 135	13.5 X13.5	2213678-5 2213678-6 4-2213678-5 (2)			
PANASONIC C15 135	13.5 X13.5	2213678-5 2213678-6 4-2213678-5 (2)			
PANASONIC C14 1919	19.0 X 19.0			2213254-1 2213254-2	
PANASONIC DMC 12CC	27.6 X 28.0			2213480-1 4-2213480-1 (4)	
PANASONIC DMC 17CC	27.6 X 28.0			2213480-1 4-2213480-1 (4)	
PANASONIC DMS120	27.6 X 28.0			2213480-1 4-2213480-1 (4)	
PANASONIC DMS150	27.6 X 28.0			2213480-1 4-2213480-1 (4)	
PANASONIC DMS12CC40G	27.6 X 28.0			2213480-1 4-2213480-1 (4)	

PHILIPS FORTIMO SLM C PW G6 2024	20.0 X 24.0		2325811-2 1-2325811-2 4-2325811-2 (3)		
PHILIPS FORTIMO SLM VO LES10 G1	13.5 X 13.5	2213678-5 2213678-6 4-2213678-5 (2)			
PHILIPS FORTIMO SLM VO LES15 G1	19.0 X 19.0		2325807-3 1-2325807-3 4-2325807-3 (3)		
PHILIPS FORTIMO SLM VO LES22 G1	28.0 X 28.0			2213480-1 4-2213480-1 (4)	

SAMSUNG LC013B	13.5 X 13.5	2213678-5 2213678-6 4-2213678-5 (2)			2-2154857-3
SAMSUNG LC026B	21.5 X 21.5			2213258-1 2213358-2	2-2154857-3
SAMSUNG LC033B	21.5 X 21.5			2213258-1 2213358-2	2-2154857-3
SAMSUNG LC040B	21.5 X 21.5			2213258-1 2213358-2	2-2154857-3
SAMSUNG LC010C	13.5 X 13.5	2213678-5 2213678-6 4-2213678-5 (2)			
SAMSUNG LC020C	19.0 X 19.0			2213254-1 2213254-2	
SAMSUNG LC030C	19.0 X 19.0		2325807-2 1-2325807-2 4-2325807-2 (3)	2213254-1 2213254-2	
SAMSUNG LC040C	16.0 X 19.0	2213929-5 2213929-6 1-2213929-5 1-2213929-6			
SAMSUNG LC040C	19.0 X 19.0		2325807-2 1-2325807-2 4-2325807-2 (3)	2213254-1 2213254-2	
SAMSUNG LC003D	13.5 X 13.5	2213678-5 2213678-6 4-2213678-5 (2)			
SAMSUNG LC006D	13.5 X 13.5	2213678-5 2213678-6 4-2213678-5 (2)			
SAMSUNG LC009D	13.5 X 13.5	2213678-5 2213678-6 4-2213678-5 (2)			

LED TYPE	LED REFERENCE DIMENSION	LUMAWISE LED HOLDER TYPE (BOLD text indicates preferred part numbers)			
		Z35	Z45	Z50	SCALABLE
SAMSUNG LC013D	13.5 X 13.5	2213678-5 2213678-6 4-2213678-5 (2)			
SAMSUNG LC016D	19.0 X 19.0		2325807-2 1-2325807-2 4-2325807-2 (3)	2213254-1 2213254-2	
SAMSUNG LC019D	19.0 X 19.0		2325807-2 1-2325807-2 4-2325807-2 (3)	2213254-1 2213254-2	
SAMSUNG LC026D	19.0 X 19.0		2325807-2 1-2325807-2 4-2325807-2 (3)	2213254-1 2213254-2	
SAMSUNG LC033D	19.0 X 19.0		2325807-2 1-2325807-2 4-2325807-2 (3)	2213254-1 2213254-2	
SAMSUNG LC040D	28.0 X 28.0			2213480-1 4-2213480-1 (4)	2-2154857-2
SAMSUNG LC060D	28.0 X 28.0			2213480-1 4-2213480-1 (4)	2-2154857-2
SAMSUNG LC080D	28.0 X 28.0			2213480-1 4-2213480-1 (4)	2-2154857-2

SEOUL SAWS0661A	13.5 X 13.5	2213678-5 2213678-6 4-2213678-5 (2)			
SEOUL SAWS1063A	13.5 X 13.5	2213678-5 2213678-6 4-2213678-5 (2)			
SEOUL SAWx22AAA	28.0 X 28.0			2213480-1 4-2213480-1 (4)	
SEOUL SBW2F1B	19.0 X 19.0			2213254-1 2213254-2	
SEOUL SBW3F1A	19.0 X 19.0			2213254-1 2213254-2	
SEOUL SDW02F1C	19.0 X 19.0			2213254-1 2213254-2	
SEOUL SDW05F1C	28.0 X 28.0			2213480-1 4-2213480-1 (4)	
SEOUL SDW81F1DY ZC4	13.5 X 13.5	2213678-5 2213678-6 4-2213678-5 (2)			
SEOUL SDW85F1C	28.0 X 28.0			2213480-1 4-2213480-1 (4)	
SEOUL SDWX2F1A	19.0 X 19.0		2325807-2 1-2325807-2 4-2325807-2 (3)		
SEOUL SDWX3F1C	19.0 X 19.0		2325807-2 1-2325807-2 4-2325807-2 (3)	2213254-1 2213254-2	
SEOUL SBWW1F1A	13.25 X 13.25				2-2154857-1
SEOUL SBWW2F1A	17.75 X 17.75				2-2154857-2
SEOUL ZC6	13.5 X 13.5	2213678-5			
SEOUL ZC12	19.0 X 19.0		2325807-3 1-2325807-3	2213254-1 2213254-2	
SEOUL ZC18	19.0 X 19.0		2325807-3 1-2325807-3	2213254-1 2213254-2	
SEOUL ZC25	28.0 X 28.0			2213480-1 4-2213480-1 (4)	

LED TYPE	LED REFERENCE DIMENSION	LUMAWISE LED HOLDER TYPE (BOLD text indicates preferred part numbers)			
		Z35	Z45	Z50	SCALABLE
SEOUL ZC40	28.0 X 28.0			2213480-1 4-2213480-1 (4)	
SHARP MEGA-ZENIGATA	24.0 X 20.0				2-2154857-3
SHARP MINI-ZENIGATA	12.0 X 15.0	2213678-3 2213678-4 4-2213678-3 (2)			2-2154857-1
SHARP MEGA TUNEABLE WHITE GW6TGBJC50C	20.0 X 24.0		2325811-2 1-2325811-2 4-2325811-2 (3)		
SHARP MEGA ZENIGATA GW5DGC**M04	20.0 X 24.0		2325811-2 1-2325811-2 4-2325811-2 (3)		

TRIDONIC SLE ADV8 LES4	13.5 X 13.5	2213678-5 2213678-6 4-2213678-5 (2)			
TRIDONIC SLE ADV8 LES6	13.5 X 13.5	2213678-5 2213678-6 4-2213678-5 (2)			
TRIDONIC SLE ADV8 LES9	13.5 X 13.5	2213678-5 2213678-6 4-2213678-5 (2)			
TRIDONIC SLE ADV8 LES13	19.0 X 19.0		2325807-2 1-2325807-2 4-2325807-2 (3)		
TRIDONIC SLE ADV8 LES15	19.0 X 19.0		2325807-2 1-2325807-2 4-2325807-2 (3)		
TRIDONIC SLE ADV8 LES17	28.0 X 28.0			2213480-1 4-2213480-1 (4)	
TRIDONIC SLE ADV8 LES21	28.0 X 28.0			2213480-1 4-2213480-1 (4)	
TRIDONIC SLE-G5-LES6	13.5 X 13.5	2213678-5 2213678-6 4-2213678-5 (2)			
TRIDONIC SLE-G5-LES11	13.5 X 13.5	2213678-5 2213678-6 4-2213678-5 (2)			
TRIDONIC SLE-G5-LES15	19.0 X 19.0			2213254-1 2213254-2	
TRIDONIC SLE-G6-LES10	13.5 X 13.5	2213678-5 2213678-6 4-2213678-5 (2)			
TRIDONIC SLE-G6-LES15	19.0 X 19.0			2213254-1 2213254-2	
TRIDONIC SLE-G6-LES17	19.0 X 19.0			2213254-1 2213254-2	2-2154857-1 (2 PC) 6-2154874-2 (1 PC)
TRIDONIC SLE-G6-SNC	19.0 X 19.0		2325807-2 1-2325807-2 4-2325807-2 (3)		
TRIDONIC SLE-G6 LES 10 ADV	13.5 X 13.5	2213678-5 2213678-6 4-2213678-5 (2)			2-2154857-1 (2 PC) 6-2154874-1 (1 PC)
TRIDONIC SLE-G6 LES 15 SNC/ADV	19.0 X 19.0			2213254-1 2213254-2	2-2154857-1 (2 PC) 6-2154874-2 (1 PC)
TRIDONIC SLE-G6 LES 17 SNC/ADV/EXC	19.0 X 19.0			2213254-1 2213254-2	2-2154857-1 (2 PC) 6-2154874-2 (1 PC)
TRIDONIC SLE-G7-LES9	13.5 X 13.5	2213678-5 2213678-6 4-2213678-5 (2)			
TRIDONIC SLE-G7-LES13	19.0 X 19.0		2325807-2 1-2325807-2 4-2325807-2 (3)	2213254-1 2213254-2	

LED TYPE	LED REFERENCE DIMENSION	LUMAWISE LED HOLDER TYPE (BOLD text indicates preferred part numbers)			
		Z35	Z45	Z50	SCALABLE
TRIDONIC SLE-G7-LES15	19.0 X 19.0		2325807-2 1-2325807-2 4-2325807-2 (3)	2213254-1 2213254-2	
VOSSLOH-SCHWABE VAS-125	19.0 X 19.0			2213254-1 2213254-2	
VOSSLOH-SCHWABE VAS-127	19.0 X 19.0			2213254-1 2213254-2	

- (1) Customer to verify electrical compatibility with CoB. Refer to product specific Application Specification 114-133082 for parameters such as input power, thermal management and output currents.
- (2) Designed to accept LEDiL Elise 50 Reflector Assembly.
- (3) Designed to accept LEDiL Elise 70 Reflector Assembly.
- (4) Designed to accept LEDiL Elise 100 Reflector Assembly.