

Nylon Closed End Splices**NOTE**

All numerical values are in metric units [with U.S. customary units in brackets]. Dimensions are in millimeters [and inches]. Unless otherwise specified, dimensions have a tolerance of ± 0.13 [± 0.005] and angles have a tolerance of $\pm 2^\circ$. Figures and illustrations are for identification only and are not drawn to scale.

1. INTRODUCTION

This specification covers the requirements for application of nylon closed end splices. The splices consist of metal inserts insulated with nylon. The splices are available in sizes 22-14 and 22-10. The splices accept a combination of solid and stranded wires for single and multiple applications. The flared end of the insulation allows insertion of wires that meet maximum voltage ratings, available in two types: ECN with a rating of 300 V and EC with ratings of 600 V for building wiring and 1,000 V for fixture and sign wiring. The splices are color coded to provide a visual reference applicable to the maximum temperature rating the splice can withstand: transparent is rated at 105°C [221°F] and black is rated at 150°C [302°F]. Each splice is marked on the center of the splice with listing agencies (UL and CSA), type (EC or ECN), and wire size range suitable for the splice. The splices are available in loose-piece for terminating with manual and pneumatically-powered hand-held tools and in tape-mounted form for terminating with semi-automatic hand-held tools and electrically-powered machines.

When corresponding with personnel, use the terminology provided in this specification to facilitate your inquiries for information. Basic terms and features of this product are provided in Figure 1.

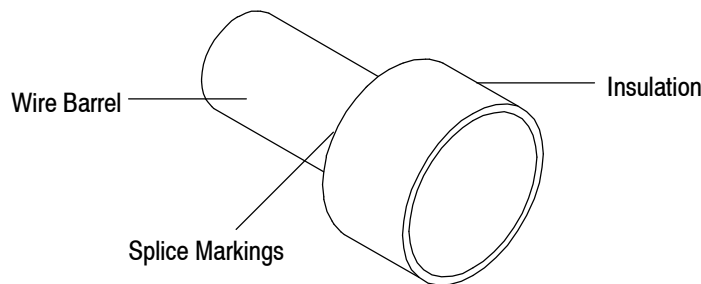

Figure 1

2. REFERENCE MATERIAL**2.1. Revision Summary**

Revisions to this application specification include:

- Updated document to corporate requirements.

2.2. Customer Assistance

Reference Product Base Part Number 328730 and Product Code 3247 are representative of nylon closed end splices. Use of these numbers will identify the product line and expedite your inquiries through a service network established to help you obtain product and tooling information. Such information can be obtained through a local Representative or, after purchase, by calling PRODUCT INFORMATION at the number at the bottom of page 1.

2.3. Drawings

Customer Drawings for product part numbers are available from the service network. If there is a conflict between the information contained in the Customer Drawings and this specification or with any other technical documentation supplied, call PRODUCT INFORMATION at the number at the bottom of this page.

2.4. Instructional Material

Instruction Sheets (408-series) provide assembly instructions, and Customer Manuals (409-series) provide machine setup and operation procedures. Documents available which pertain to this product are:

408-9816 Handling of Reeled Products

A. Wire Combinations

408-1003 Solid and stranded wire sizes 22-10 AWG for EC splices
408-1021 Solid and stranded wire sizes 22-10 AWG for ECN splices
408-1271 Solid and stranded wire sizes 22-14 AWG for ECN splices
408-8806 Solid and stranded wire sizes 22-14 AWG for ECN splices
408-8807 Solid and stranded wire sizes 22-10 AWG for EC splices

B. Tooling

408-1539 Hand Crimping Tool 46866 (Wire Sizes 22-10 AWG)
408-1578 Hand Crimping Tools 45216 (Wire Sizes 22-14 AWG) and 45219-2 (Wire Sizes 22-10 AWG)
408-1634 Crimping Dies 45218 (Wire Sizes 22-14 AWG) and 45221 (Wire Sizes 22-10 AWG)
408-2095 Hand Crimping Tool 69710-1
408-2254 Crimping Die Assemblies 69950, 69951, and 69952
408-4105 Straight-Action Crimper 217200-1
408-4145 PRO-CRIMPER* III Hand Tool Assembly 217212-1 (with Die Assembly 217212-2)
408-4190 C-Head Pneumatic Adapter (Crimper) 318161-1
408-4303 Pneumatic CERTI-CRIMP* (Small) Tool Holder Assembly 356303-1 (Logic)
408-7424 Checking Crimp Height or Gaging Die Closure
408-8082 Miniature Quick Change Applicators (Side-Feed Type)
408-9641 Straight Action Air Tool Die Assembly 47811 (Wire Sizes 22-10 AWG)
408-9893 626 Pneumatic Head Assembly 354422-1
408-9906 626 Pneumatic Crimping Head 354422-2
408-9930 PRO-CRIMPER III Hand Crimping Tool Frame Assembly 354940-1
409-1993 AMP-TAPETRONIC* Machine 69875
409-5128 Basic AMP-O-LECTRIC* Model "K" Terminating Modified Machine 471273-[]
409-5842 AMP-O-LECTRIC Model "G" Terminating Machine 354500-[]
409-5862 626 Pneumatic Tooling Assemblies 189721-[] and 189722-[]
(Use with Small Tool Holder Assembly 189766-1 Non-Logic or
Straight Action Tool Holder Assembly 189928-1 Non-Logic)

3. REQUIREMENTS

3.1. Material

The splice body is made of copper plated with tin, and the insulation is made of nylon. The insulation is highly resistant to abrasion.

3.2. Storage

A. Shelf Life

The splices should remain in the shipping containers until ready for use to prevent deformation to the splices. The splices should be used on a first in, first out basis to avoid storage contamination that could adversely affect performance.



It is important that the splices remain in the protective poly bags until ready for use; a moist or dry environment may adversely affect the hygroscopic material used in the splice insulation.

B. Ultraviolet Light

Prolonged exposure to ultraviolet light may deteriorate the chemical composition used in the insulation material.

C. Reeled Splices

When using tape-mounted reeled splices, care must be taken to prevent stretching, sagging, or other distortion that would prevent smooth feeding of the tape through automatic machine feed mechanisms. Store coil wound reels horizontally and traverse wound reels vertically.

3.3. Chemical Exposure

Do not store splices near any chemical listed below as they may cause stress corrosion cracking in the splices.

Alkalies	Ammonia	Citrates	Phosphates	Citrates	Sulfur Compounds
Amines	Carbonates	Nitrites	Sulfur Nitrites		Tartrates

3.4. Wire Selection and Preparation

The splices will accept solid and stranded copper wire sizes 22 through 10 AWG (509 through 13,100 circular mil area). Various combinations of wires for each splice are listed on the applicable wire combination chart packaged with the splice. The length of the exposed conductors may vary depending upon the number of wires used in the application. Proper strip length is necessary to properly insert the wire into the splice. The strip length of the wire is shown in Figure 2.

CAUTION Reasonable care must be taken not to nick, scrape, or cut any strands during the stripping operation.

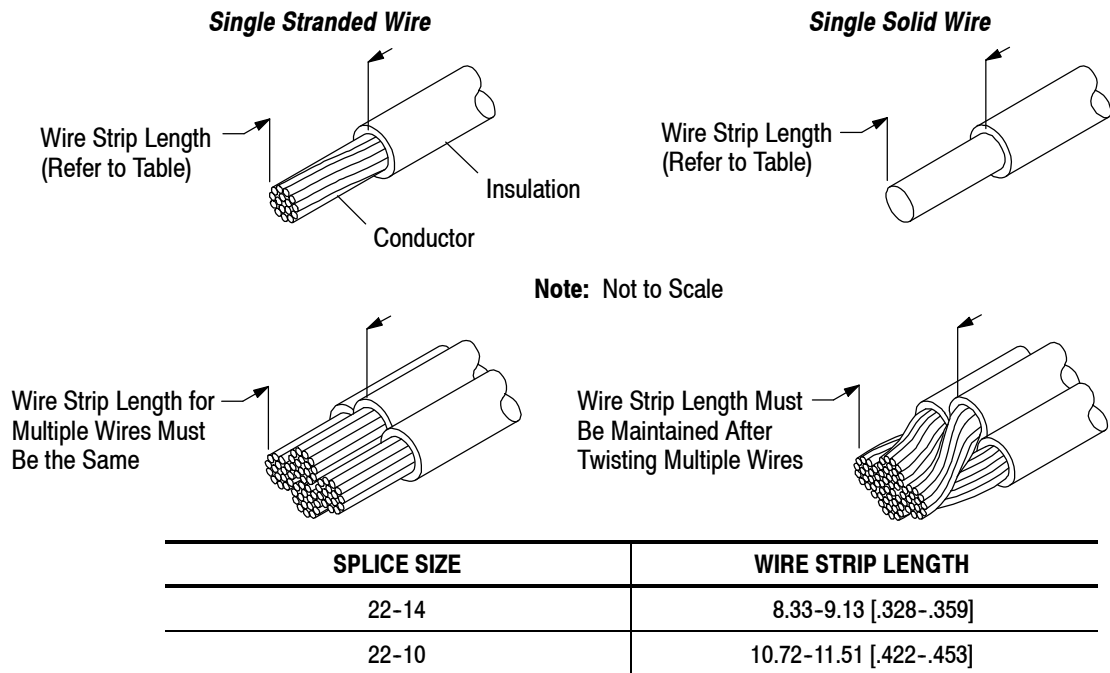

Figure 2

3.5. Wire Placement

Stranded wire conductors must be inside the splice wire barrel. No strands can be folded back over the wire insulation. Conductor ends must be bottomed in the wire barrel. The wire insulation must be inside the insulation of the splice, but must not enter the wire barrel, to provide strain relief for the wire.

If local production requirements allow, to prevent the conductors from flaring out, conductors can be twisted together to form a tight bundle before inserting them into the splice. If conductors are twisted, wire strip length must be maintained after twisting.

3.6. Crimp Requirements

The splice must be crimped to the wire according to instructions packaged with applicable tooling.

A. Wire Barrel Crimp

The crimp applied to the wire barrel portion of the splice is the most compressed area and is most critical in ensuring optimum electrical and mechanical performance of the crimped splice. The crimped area must be symmetrical on both sides of the wire barrel of the splice. The crimp may be off center on the wire barrel but not off the end of the wire barrel. See Figure 3.

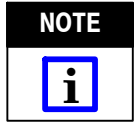

The resilience of the splice insulation prevents accurate direct measurement of crimp height. Crimp height can be obtained by measuring a crimped solder slug (60% tin and 40% lead) with a diameter comparable to the wire size. The slug must be measured over the most compressed area of the slug with a standard micrometer or crimp height comparator (refer to 408-7424 for specific instructions). The solder slug diameter and crimp height must be within the dimensions provided in Figure 3.

B. Wire Conductor and Insulation Location

Wire conductor ends must be flush to the end of the wire barrel. All conductors must be held firmly inside the wire barrel. No strands can be folded back over the wire insulation. The wire insulation must be inside the insulation of the splice, but must not enter the wire barrel. See Figure 3.



Wire insulation shall NOT be cut or broken during the crimping operation. Reasonable care should be taken to provide undamaged wire terminations.

C. Splice Insulation

The splice insulation must not be deformed, cut, or show uneven stress marks.

D. Flash

There shall be no flash or extruded insulation visible in the crimped area. See Figure 3.

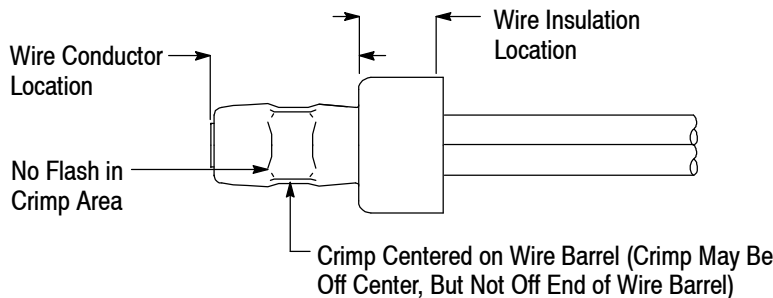

SPLICE		SOLDER SLUG	
SIZE	TYPE	DIAMETER	CRIMP HEIGHT
22-14	ECN	6.35 [.250]	2.31-2.46 [.091-.097]
22-10	EC	6.35 [.250]	2.92-3.05 [.115-.120]
	ECN		3.12-3.25 [.123-.128]

Figure 3

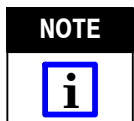

Each crimp height dimension represents the functional range of a wire and splice combination. The developed crimp configuration is unique for each tool design and is acceptable provided the crimp height is within the functional range. For crimp height dimensions for a specific tool, refer to instruction sheet packaged with manual tools and applicator log packaged with power tools.

E. Tensile Strength

Crimped splices must hold the wire firmly and have a crimp pull-out test value meeting that specified in Figure 4 (the test value is that of the smallest wire size used in the splice).

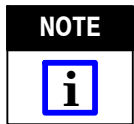

Adjust tensile testing machine for head travel of 25.4 [1.0] per minute. Directly and gradually apply force for one minute.

WIRE SIZE (AWG)□	TENSILE FORCE (N [lb]) Min
22	35 [8]
20	44 [10]
18	44 [10]
16	66 [15]
14	111 [25]
12	155 [35]
10	178 [40]

□ Use the smallest wire size in the splice to determine tensile strength.

Figure 4

3.7. Repair

Damaged splices or splices that do not meet crimp dimension requirements must be removed from wires, discarded, and replaced with new ones. When removing a splice, cut the wires as close as possible to the end of the wire barrel.

4. QUALIFICATION

Nylon closed end splices are Listed by Underwriters Laboratories Inc. (UL) in File E13288 and Certified by CSA International in File LR 7189.

5. TOOLING

Hand tools for manual application of loose piece splices and semi-automatic machines for power assisted application of tape-mounted splices are available to cover the full wire size range. Tooling part numbers and instructional material packaged with the tooling are given in Figure 5.

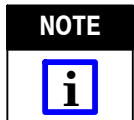

Modified designs and additional tooling concepts may be available to meet other application requirements. Machines have been designed for a variety of application requirements. For assistance in setting up prototype and production line equipment, contact your local Representative or call the TOOLING ASSISTANCE CENTER at the number at the bottom of page 1.

5.1. 626 Pneumatic Tooling System

The pneumatic tooling system consists of a pneumatic power unit, tool holder assembly, and variety of crimping heads used to crimp splices onto pre-stripped wire. This tooling system was developed to reduce operator fatigue and provide interchangeability of die assemblies. The system is designed for prototype and medium-volume application of loose piece splices.

5.2. Semi-Automatic Machines

A. Applicator

The applicator is designed to crimp tape-mounted splices onto pre-stripped wire, and provides for high volume, heavy duty production requirements. The applicator must be installed onto a power unit. The applicator used to crimp these splices includes crimping dies.

B. Power Units

Power units provide the force required to drive applicators. These power units are designed to be bench mounted. The AMP-TAPETRONIC machine consist of a basic AMP-O-LECTRIC Model “K” terminating machine and applicator (which does not include applicable crimping dies) required to crimp the splices.

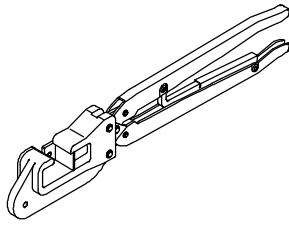

Hand Crimping Tool
69710-1 (408-2095)

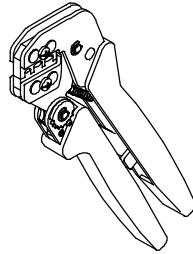

PRO-CRIMPER III Hand Tool
Assembly 217212-1 with Die
Assembly 217212-2 (408-4145)
PRO-CRIMPER III Hand
Crimping Tool Frame Assembly
354940-1 (408-9930)

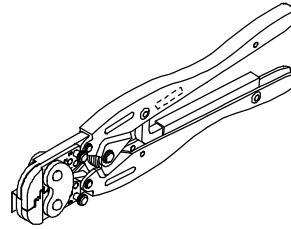

Hand Crimping Tool 46866
Wire Sizes 22-10 AWG
(408-1539)
Hand Crimping Tools 45216
Wire Sizes 22-14 AWG
and 45219-2
Wire Sizes 22-10 AWG
(408-1578)

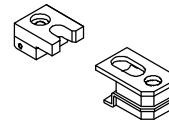

Crimping Dies 45218
and 45221 (408-1634)
Straight Action Air Tool
Die Assembly 47811
(408-9641)
Crimping Die Assemblies
69950, 69951, and
69952 (408-2254)

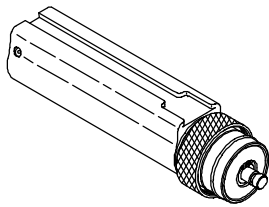

626 Pneumatic Tooling
Assemblies 189721-[]
and 189722-[]
(409-5862)

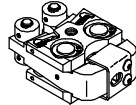

626 Pneumatic Head Assembly
354422-1 (408-9893)
626 Pneumatic Crimping Head
354422-2 (408-9906)

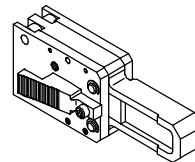

Straight Action Crimper
217200-1 (408-4105)

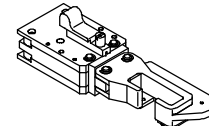

C-Head Pneumatic Adapter
(Crimper) 318161-1
(408-4190)

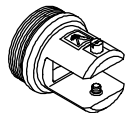

Small Tool Holder Assembly 189766-1
(Non-Logic) (409-5862)
Pneumatic CERTI-CRIMP (Small) Tool Holder
Assembly 356303-1 (Logic) (408-4303)

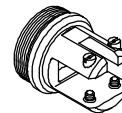

Straight Action Tool Holder
Assembly 189928-1 (Non-Logic)
(409-5862)

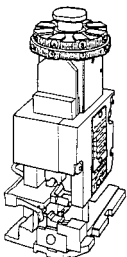

Heavy-Duty Miniature
Tape Applicator 680300-2
(408-8082)

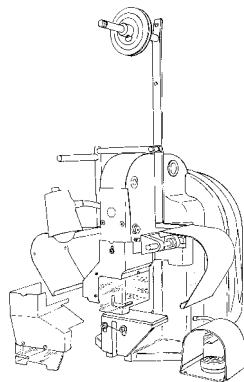

Basic AMP-O-LECTRIC Model "K"
Terminating Machine 471273-[]
(409-5128)

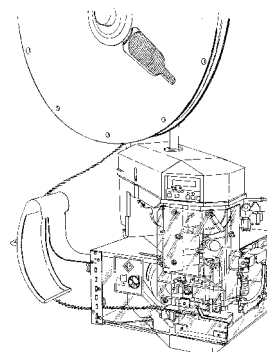

AMP-O-LECTRIC Model "G"
Terminating Machine
354500-1 (409-5842)

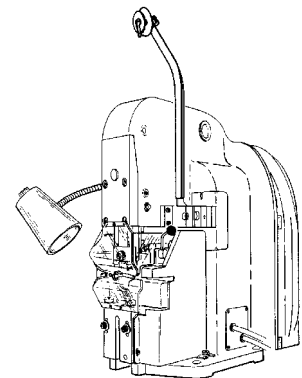

AMP-TAPETRONIC
Machine 69875
(409-1993)

Figure 5 (Cont'd)

SPLICE		CRIMPING DIE	HAND TOOL	TOOL HOLDER ASSEMBLY	HEAD OR ADAPTER	APPLICATOR	POWER UNIT
SIZE	TYPE						
22-14	ECN	—	45216	—	—	—	—
		—	217212-1	—	—	—	—
		45218	69710-1	—	—	—	—
		217212-2	354940-1	—	—	—	—
		—	189721-1 or 189722-1	189766-1 or 356303-1	354422-1▪	—	—
		45218				189928-1	217200-1
		45218	189721-2 or 189722-2	189928-1	318161-1	—	—
22-14	ECN	69951	—	—	—	—	69875
22-10	EC	—	46866	—	—	—	—
		—	217212-1	—	—	—	—
		—	189721-1 or 189722-1	189766-1 or 356303-1	354422-2	—	—
		69952	—	—	—	—	69875
		—	—	—	—	680300-2	354500-1 or 471273-[]
	ECN	—	45219-2	—	—	—	—
		—	217212-1	—	—	—	—
		45218	69710-1	—	—	—	—
		47811	189721-1 or 189722-1	189928-1	217200-1	—	—
		47811	189721-2 or 189722-2	189928-1	318161-1	—	—
22-10	ECN	69950	—	—	—	—	69875

- Most solid wire combinations cannot be used with Head 354422-1 because the jaws cannot be partially closed. These combinations generally require at least one stranded wire.

Figure 5 (End)

6. VISUAL AID

The illustration below shows a typical application of nylon closed end splice. This illustration should be used by production personnel to ensure a correctly applied product. Applications which DO NOT appear correct should be inspected using the information in the preceding pages of this specification and in the instructional material shipped with the product or tooling.

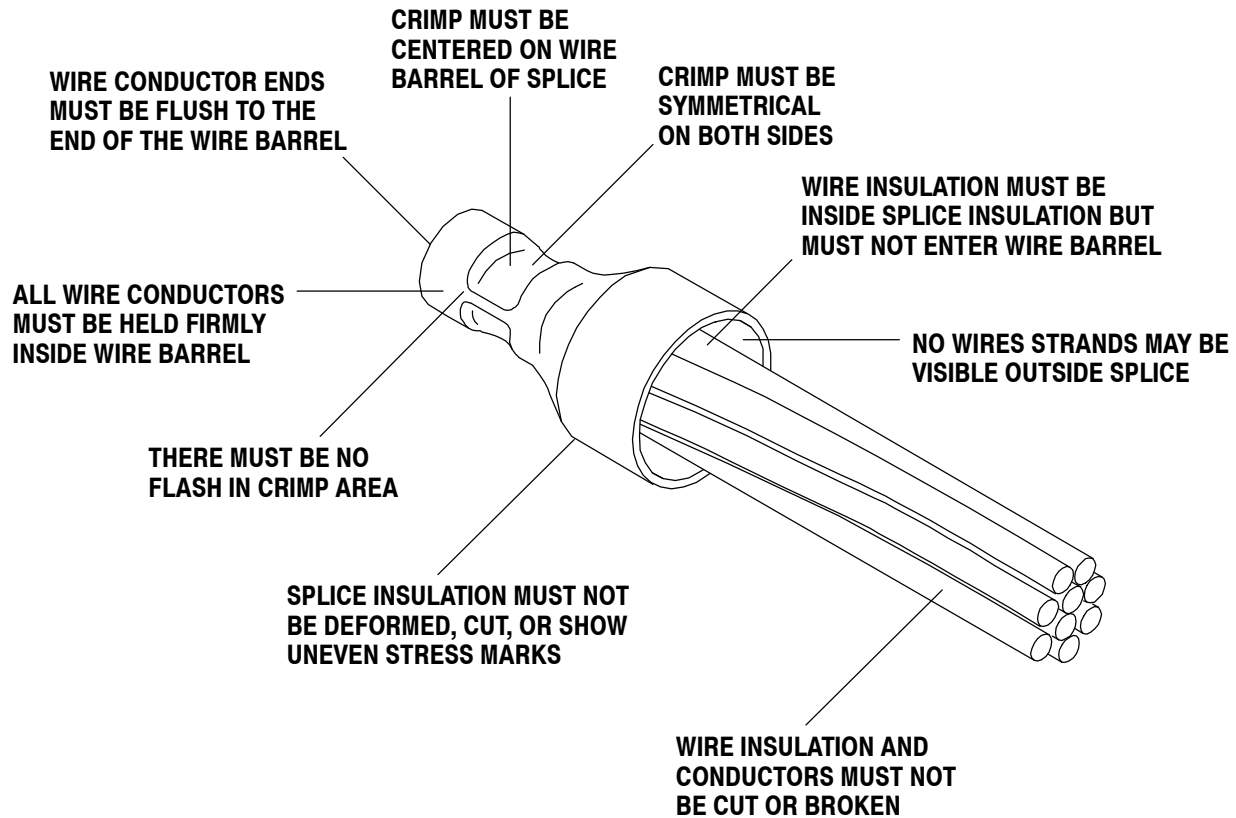

FIGURE 6. VISUAL AID