

CIRP Series

Circular Multi-pin Electrical Connectors

Assembly and Wiring Instructions

PRJ-15-000001392

THIS IS A CLASS 1 DOCUMENT WHICH IS NONCONFIDENTIAL.

The information contained within this document is the property of TE Connectivity. It is supplied in confidence and the commercial security of the contents must be maintained. It must not be used for any purpose other than that for which it is supplied nor may any information contained in it be disclosed to unauthorised persons. It must not be reproduced in whole or in part without obtaining written permission from TE Connectivity (TE).

While TE has made every reasonable effort to ensure the accuracy of the information in this catalog, TE does not guarantee that it is error-free, nor does TE make any other representation, warranty or guarantee that the information is accurate, correct, reliable or current. TE reserves the right to make any adjustments to the information contained herein at any time without notice. TE expressly disclaims all implied warranties regarding the information contained herein, including, but not limited to, any implied warranties of merchantability or fitness for a particular purpose. The dimensions in this catalog are for reference purposes only and are subject to change without notice. Specifications are subject to change without notice. Consult TE for the latest dimensions and design specifications.

*Trademark. TE Connectivity, TE connectivity (logo), and TE (logo) are trademarks. Other logos, product and/or company names may be trademarks of their respective owners.

Table of contents

1	Product Introduction	3
1.1	General	3
1.2	Typical Connector	4
2	Connector Description and Terminology	5
2.1	CIRP Free Connector	5
2.2	CIRP Fixed Connector	6
3	Backshells and Accessories	7
4	Polarisation	8
4.1	Insert Orientation	8
4.2	Alignment Pin	9
5	Individual Wire Termination	10
5.2	Individual Wire Termination (Crimping Cables)	11
5.3	Individual Wire Termination (Contact insertion Method 1)	12
5.4	Individual Wire Termination (Contact insertion Method 2)	14
6	Contact Extraction	15
7	Screen termination system	17
7.2	Method: A: Termination Procedure For In-line Wire Bundles	18
7.3	Procedure for a Fixed Connector with (SCHSA)	18
7.4	Method B: RFI Grounding	21
7.5	Procedure Shown Of Free Connector With ECHSA Accessory	21
7.6	Method C: Electrical Termination	22
7.7	Method D: Electrical Termination (90 Degree Elbow)	25

Appendices

Appendix A:	Tooling data	26
Appendix B:	Dimensional positions of contacts in fixed & free shells	31
Appendix C:	Guidance for the use of 90° backshells	32
Appendix D:	Steel Band Termination Assembly Process	33
Appendix E:	Backshell Torque Values.	35
Appendix F:	Trouble Shooting	36

1 PRODUCT INTRODUCTION

1.1 General

- 1.1.1 The CIRP connector series is based on the MS Bayonet lock series of connectors conforming to MIL-C-5015 specification. They are interchangeable with all corresponding MS bayonet lock types and feature identical panel mounting dimensions.
- 1.1.2 Designed to operate within a temperature range of -55°C to +125°C, the connector also meets the mechanical and environmental ratings of BS9522 F0032, VG95234 and NF-F-61-030.
- 1.1.3 Unlike other MIL-C-5015 bayonet connectors, which utilise insulators bonded into the shell and or bonded or rubber retained contacts, the CIRP connector series incorporates a Circlip retained solid plastic insulator and metal clip retained contacts.
- 1.1.4 Stainless steel bayonet pins and rollers riding along the three cam tracks machined into the receptacle shell achieve the connector coupling. Coupling integrity is guaranteed by:
- Firstly having three stainless steel pins at the critical wear points of the receptacle shell cam-tracks and secondly, by positive lock indicators in the form of
 - An audible click when fully mated.
 - Alignment of coloured dots when fully mated.
- 1.1.5 CIRP connectors are available in 7 sizes from shell size 18 to shell size 40 with arrangements having 7 to 60 contacts.
- 1.1.6 Crimp contacts are available in sizes 16, 12 and 8 AWG.
- 1.1.7 Insulator angular orientation is available for occasions where like connectors are in close proximity and cross mating has to be avoided. This is achieved by aligning predetermined keyways in the insulator with the master key of the plug and receptacle shell. These angular positions are in accordance with the MIL-C-5015 specification thereby ensuring compatibility with existing equipment.
- 1.1.8 The dynamic sealing ring at the base of the plug shell guarantees high reliability and anti-vibration characteristics including the stainless steel pins at the cam track critical wear points.
- 1.1.9 Environmental sealing of mated connectors to IP67 is achieved by compression of the dynamic seal ring, while integrity at the rear is achieved by the use of an individual wire seal grommet with membranes being penetrated only when a wire is present.
- 1.1.10 Electrical continuity between connectors is achieved by ensuring compression of the wavy and flat washer assembly at the base of the plug shell.
- 1.1.11 Screen termination is simplified by using one of a range of back shell/accessory combinations.
- 1.1.12 In summary, the CIRP modular bayonet coupling connector offers several advantages to the user.
- Metal clip retained removable crimp contacts.
 - Positive lock location of contacts.
 - Circlip retained removable insulator allowing for angular re-positioning.
 - Rapid coupling and uncoupling. 120° rotation of the coupling nut.
 - Vibration resistant -loosening of the coupling nut under vibration or shock condition is prevented.
 - Inter-matable and interchangeable with other Mil-C-5015 bayonet types.

1.2 Typical Connector

Fixed
(Receptacle)

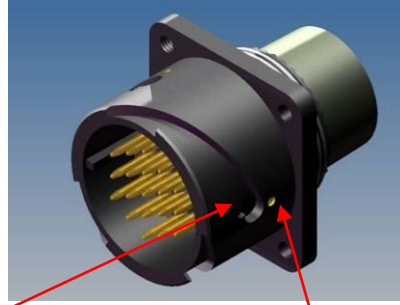

Stainless steel pins

Alignment indicator

Free
(Plug)

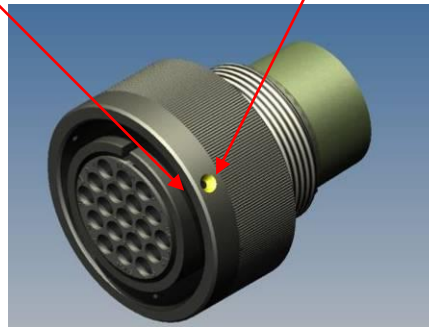

Standard Data

1.2.1 Materials

Shell:	Aluminium Alloy
Insulator:	Hard Plastic, Low fire hazard
Grommet:	Rubber, Low fire hazard
Contacts:	Copper Alloy
Retaining Clip:	Beryllium Copper
Accessory:	Aluminium Alloy

1.2.2 Plating Finishes

Shell:	Zinc Cobalt, Black Passivation
Contacts:	Gold or Silver
Accessory:	Zinc Cobalt, Black Passivation

1.2.3 Environmental Ratings

Shock:	75g
Vibration:	5 to 500Hz long endurance, 30 hour test at 10g
Acceleration:	50g
Mechanical Endurance:	500 mating cycles minimum

2 CONNECTOR DESCRIPTION AND TERMINOLOGY

2.1 CIRP Free Connector

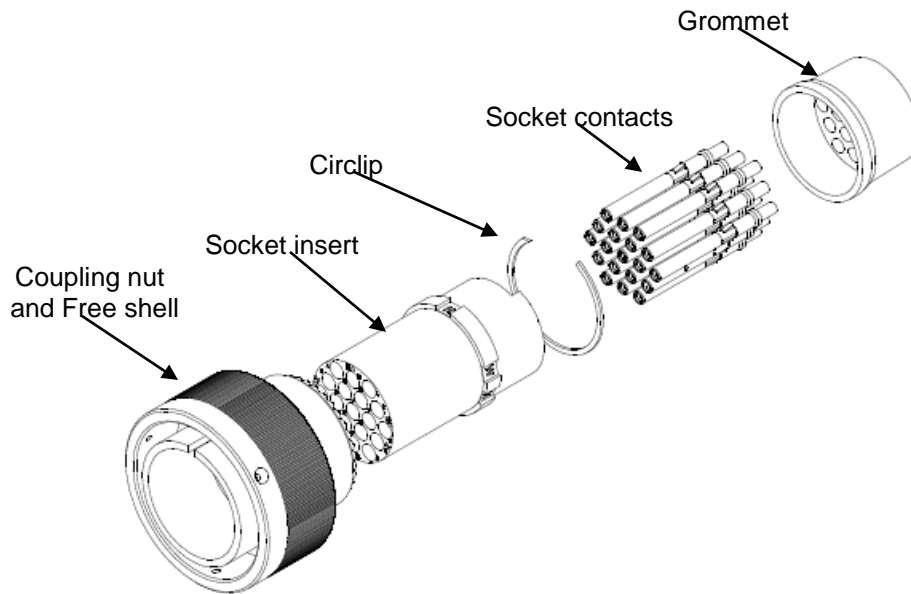

Exploded View of CIRP Free Connector

- 2.1.1 **Coupling Nut** – Provides cam force when mating and unmating connectors.
- 2.1.2 **Free Shell** – Holds the insert and incorporates an alignment key to position the insert. The free shell accommodates either the socket or pin insert to reverse gender.
- 2.1.3 **Insert (Pin or Socket)** – Removable, orientatable, retains the contacts and can be used in either fixed or free shells.
- 2.1.4 **Circlip** – Retains the insert in the shell.
- 2.1.5 **Contacts (Pin or Socket)** – Crimped to the conductors.
- 2.1.6 **Retaining clip** – Retains the contacts in the insert.
- 2.1.7 **Grommet** – Resilient rubber seal for the individual wire terminations. It has a special cut out feature to help position onto the rear of the insert. It also has a sealing web so that when the connector is not fully populated, sealing still occurs. The grommet is ink marked with the hole position identification.

2.2 **CIRP Fixed Connector**

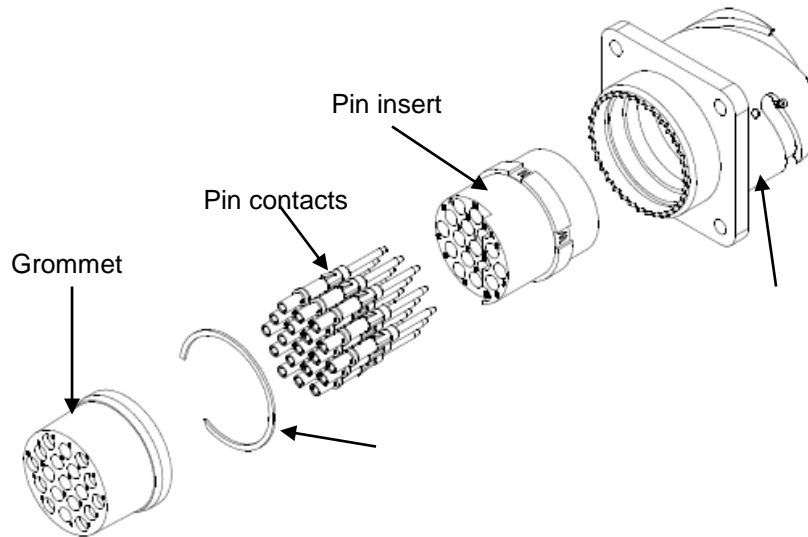

Exploded view of CIRP Fixed Connector

- 2.2.1 **Fixed Shell** – The panel mounted half of the connector pair. Holds the insert and incorporates an alignment key to position the insert. The shell accommodates either the socket or pin insert to reverse gender. Coupling ramps provide cam action for coupling and uncoupling. Stainless Steel pins at the top of the ramps ensure positive locking and long service life.
- 2.2.2 **Insert (Pin or Socket)** – Removable, orientable, retains the contacts and can be used in either fixed or free shells.
- 2.2.3 **Circlip** – Retains the insert in the shell.
- 2.2.4 **Contacts (Pin or Socket)** – Crimped to the conductors.
- 2.2.5 **Retaining clip** – Retains the contacts in the insert.
- 2.2.6 **Grommet** – Resilient rubber seal for the individual wire terminations. It has a special cut out feature to help position onto the rear of the insert. It also has a sealing web so that when the connector is not fully populated, sealing still occurs. The grommet is ink marked with the hole position identification.

3 BACKSHELLS AND ACCESSORIES

- 2.2.7 A fully sealed connector is achieved by using a grommet in combination with an accessory. When assembled on the back of the connector the accessory compresses the grommet onto the individual wires and against the accessory body to obtain an IP67 seal.
- 2.2.8 The accessory is assembled correctly when the teeth on the back of the connector shell mesh with those of the accessory.
- 2.2.9 The spinning knurled locking nut prevents grommet twist when tightening.
- 2.2.10 Accessories are available to take heat shrink boots, screening systems and conduit. Angled versions are also available, to guide cable routing. Please consult the catalogue or ask the sales desk for more information on the type available.

Hint: When engaging the accessory onto the connector, linearly push the accessory onto the fixed or free shell while rotating the accessory nut. This will ease the assembly by allowing the threads to engage more naturally. Also continue to push the accessory inwards when tightening to ease the torque required. The same applies during strip down; push forward on the accessory to slacken thread.

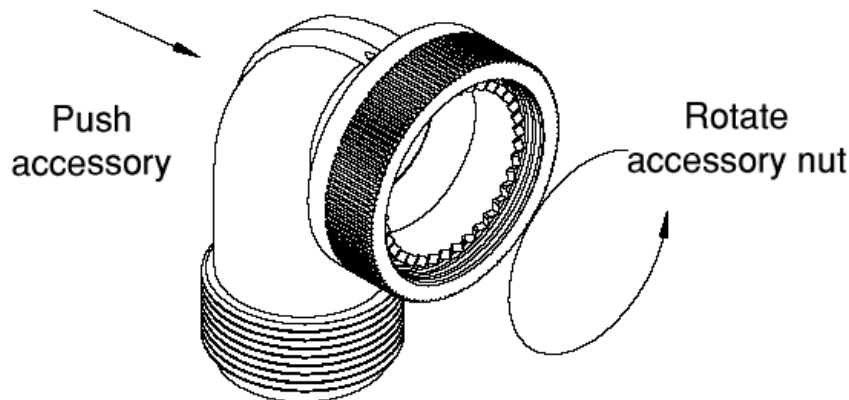

4 POLARISATION

4.1 Insert Orientation

- 4.1.1 Depending on end user needs, the pin and socket inserts may be supplied separately to the fixed and free shells to allow the end user to specify the orientation of the insulator within the connector.

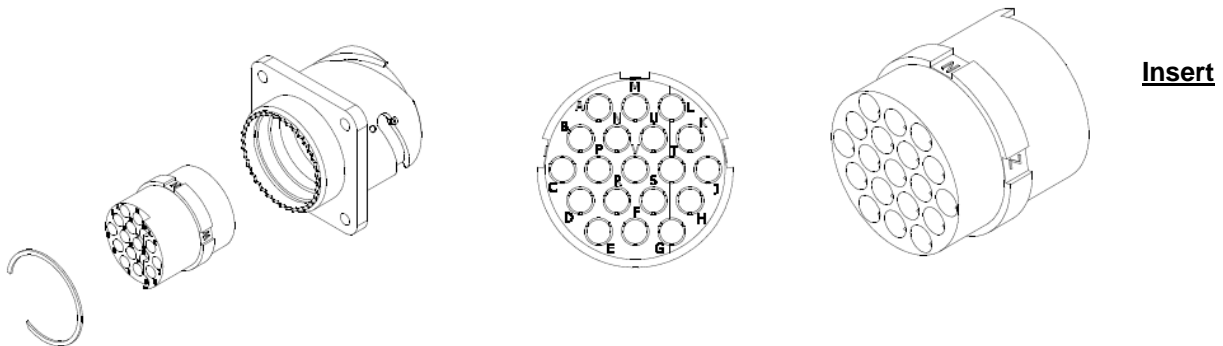

Orientation Components

- 4.1.2 Insulator orientation is used to prevent cross mating of like connectors, which are in close proximity to each other. It is achieved by firstly having a location key cast into the fixed and free shells, and secondly by the insulator having a number of location keyways moulded into the outside shoulder for each desired orientation. Each position is marked on the insulator and can also be seen on either the front face or the location keyway.
- 4.1.3 Before the circlip is used, it is best practice to bend the circlip through 90°, so that a spring washer effect is formed in the circlip. This will not only aid the assembly process, but will take up any linear movement of the insulator within the shell.



- 4.1.4 Align the insulator orientation letter required with the key in the shell and press into place. There may be a slight interference, but it can be pushed to a stop, exposing the circlip groove in the fixed or free shell.
- 4.1.5 Insert one end of the circlip into the circlip groove, and prize around using a small screwdriver until the circlip snaps into position. Attempt to push and twist the insulator to ensure that the circlip is seated correctly.
- 4.1.6 The Insulator can also be easily removed to orientate it. Locate the chamfered end of the circlip. Using a small screwdriver prise the circlip out of its groove and “ride” the screwdriver under the circlip all the way around the shell and it will pop out. The insulator can now be removed and repositioned or replaced as required.

4.2 Alignment Pin

- 4.2.1 For high density, symmetrical contact arrangements, where very few contacts are being used, additional devices may be necessary to completely remove the possibility of cross mating like connectors. These devices take the form of pins, which occupy key contact positions in the insulator depending on the size and complexity of the arrangement.
- 4.2.2 **Note.** The additional polarising device is inserted into the pin insulator only.
- 4.2.3 It is recommended that at least two of these pins be installed per connector. These alignment pins should not be removed once installed.

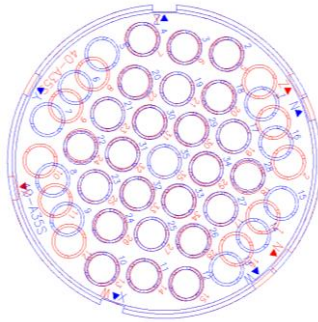

Example of two 40-A35 Contact arrangements with X and Y orientations mated together. 25 out of the 35 available contacts can misalign.

Table showing optimum position for alignment pins.

Contact arrangement	Insulator Orientation	Alignment pin position
18-19	All	Any one hole
20-15	All	Any one apart from G
22-14	All	Hole K & R
24-10	All	Any one hole apart from G
28-21	All	Holes E & e
32-A13	All	Hole 10
36-A22	All	Holes 14 & 17
40-A35	All	Holes 1 & 24
40-A60	N	Hole 3 & 51
	W, X, Y & Z	Holes 26 & 59

5 INDIVIDUAL WIRE TERMINATION

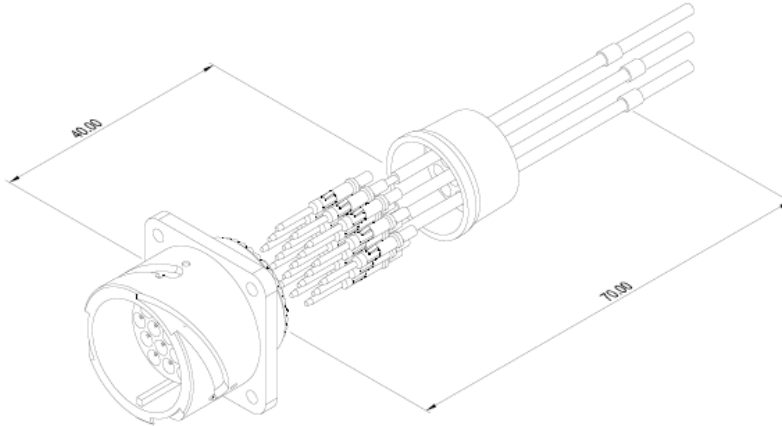

Cable preparation lengths

5.1.1 Cut cables to the desired length, which must include:

- The length of the grommet
- The strip length, as shown in the table below
- The assembly length of 40mm
- Apply cable idents and push back from approximately 70mm from the end of the wire.

5.1.2

Contact Size	TE Crimp Contact Part Number		Dimension "L" mm Strip Length
	Pin	Socket	
16/22	CIRP1622KPK#	CIRP1622KLK#	5-6mm
16/20	CIRP1620KPK#	CIRP1620KLK#	5-6mm
16	CIRP16KPK#	CIRP16KLK#	5-6mm
16/14	CIRP1614KPK#	CIRP1614KLK#	5-6mm
12/40	CIRP1240KPKP80#	CIRP1240KLKP80#	7-8mm
12/20	CIRP1220KPKP80#	CIRP1220KLKP80#	7-8mm
12/16	CIRP1216KPKP80#	CIRP1216KLKP80#	7-8mm
12	CIRP12KPKP80#	CIRP12KLKP80#	7-8mm
12/10	CIRP1210KPKP80#	CIRP1210KLKP80#	7-8mm
8/40	CIRBP840KPKP80#	CIRBP840KSKP80#	12-13mm
8/16	CIRBP816KPKP80#	CIRBP816KSKP80#	12-13mm
8/12	CIRBP812KPKP80#	CIRBP812KSKP80#	12-13mm
100	CIRBP100KPKP80#	CIRBP100KSKP80#	12-13mm
100/60	CIRBP10060KPKP80#	CIRBP10060KSKP80#	12-13mm

Strip Lengths

5.2 Individual Wire Termination (Crimping Cables)

Size 16 contact
Single sided clip.

Size 12 contact
Single sided clip.

Size 8 contact with
Retaining collet.

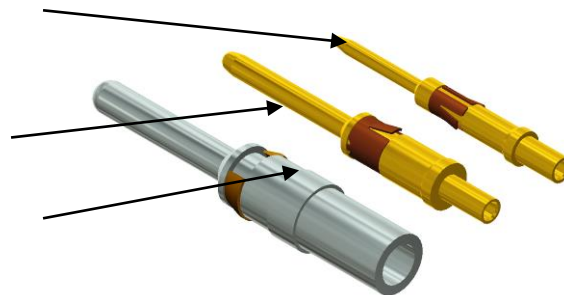

Crimp Contacts Types

- 5.2.1 Inspect the conductor to ensure the insulator end is clean and square and the lay of the strands is not disturbed.
Note: A damaged conductor or strand is not acceptable. Ensure the conductor is clean before assembly into the contact.
- 5.2.2 Select the correct crimp tool and turret/locator for the contact to be crimped from the table in Appendix A, and install the turret/locator onto the crimp tool.
- 5.2.3 Set the correct tool setting and tool position for the contact as shown in Appendix A.
- 5.2.4 Insert the stripped conductor into the contact crimp bucket. Ensure conductor is fully pushed in and that insulation is tight to crimp bucket.
- 5.2.5 Check inspection hole to see if the conductor strands are visible. If they are not visible, check the conductor strip length and check for foreign objects in the crimp bucket.
- 5.2.6 Operate the empty crimp tool once to ensure the crimping dies are completely open and there is no misalignment.
- 5.2.7 Insert the contact with the conductor installed into the contact-locating hole in the crimp tool until it 'bottoms' in the locator/turret. Applicable to size 12 & 16 only. Position the size 8 contact so that the crimp bucket rests on the bottom jaws of the die set with the back of the contact protruding approximately 2mm over the back of the die.
- 5.2.8 Activate the crimp tool through one complete cycle.
- 5.2.9 **Note:** When crimping Size 8 Contacts ensure that the flats of the Hexagonal Die Set come together.
- 5.2.10 Remove the crimped assembly from the tool and inspect the joint for the correct crimp location as below.

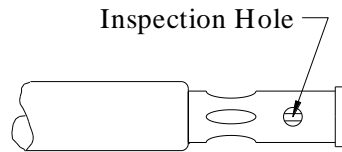

Completed crimp contact

- 5.2.11 Check that the conductor strands are visible through the inspection hole.
Important Note: Loose conductor strands or cracks in the crimp area are not acceptable. The crimp joint must be re-made if there is any sign of damage.

5.3 Contact Insertion – Method 1

- 5.3.1 Push the contacts through the grommet according to the wiring list / schedule and push the grommet up to, but not beyond the idents. Lubricant such as Pronatur or Isopropyl alcohol may be used. Important: Observe handling and operating safety instructions as supplied by manufacture.



- 5.3.2 Locate the correct hole for the appropriate wire. Load the contact into the insert by hand. **Note:** It is best practice to work from one side only, inserting from left to right or top to bottom in an orderly fashion. Some arrangements have a radial pattern where working from the centre and working outwards is best. Randomly inserting contacts is more likely to result in wiring errors and difficulty inserting contacts.

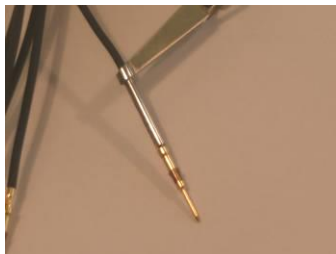

- 5.3.3 Using the correct insertion tool for the contact as shown above, locate onto contact bucket and push the contact forward until fully inserted, when a 'click' will be heard and felt.

Hint: As each contact is inserted pull firmly on the cable to ensure that the contact has seated correctly. Any contact not seated correctly will pull back. If this happens use the insertion tool and reinsert the contact and repeat the pull test.

- 5.3.4 Checking the dimensions shown in Appendix B will verify that the contact is seated correctly. As an extra final visual check, all contacts should be around the same height with no visible differences in height from insert face.
- 5.3.5 Repeat steps 5.3.4 to 5.3.6 until all wires are located into their respective holes.
- 5.3.6 Slide the grommet down the cable and locate onto the insert. Lubricant such as Pronatur or Isoproponyl alcohol may be used. Observe handling and operating safety instructions as supplied by manufacturer.
- 5.3.7 Tuck the grommet in between the connector shell and the insert until the shoulder on the grommet is pushed almost level with the top of the serrations on the shell. A simple tool is available to help when tucking the grommet into position.

Hint: If you push forward on the back face of the grommet it should not buckle. If it does then the grommet has not been tucked into position correctly. This can cause the grommet to tare when the backshell is assembled and could affect sealing.



- 5.3.8 To ensure that the correct wire number has been inserted into the correct hole, check that the lettering and step in the grommet align correctly.
- 5.3.9 Any grommet hole that has been pierced accidentally will need to be filled with a grommet filler plug as shown. Unpierced holes can be left.



- 5.3.10 Slide cable idents up to the back of the grommet and leave a 5 to 15mm gap.
- 5.3.11 Assemble the accessory onto the connector and tighten to the recommended torque values as stated in Appendix D.

Hint: When engaging the accessory to the connector, linearly push the accessory onto the fixed or free shell while rotating the accessory nut. This will ease the assembly by allowing the threads to engage more naturally. Also continue to push the accessory inwards when tightening to ease the torque required. The same applies during strip down; push forward on the accessory to slacken thread.

5.4 Contact insertion – Method 2

- 5.4.1 This alternative method involves assembling the grommet onto the connector before inserting the contacts through the grommet and into the insert. The advantage of this method is that the contacts can be crimped onto the wires before the connector and accessories are touched, however:
- 5.4.2 This method is not preferred since it requires that the contact and insertion tools penetrate the webs in the grommet. There is potential for the retaining clips on the contacts to damage the grommet sealing holes and effect the performance of the connector.
- 5.4.3 Extra care must therefore be taken when using this method and the grommet must be inspected for damage after the contacts have been fitted.
- 5.4.4 Prepare the parts as follows:
- Strip and crimp the contacts as per sections 5.2 and 5.3
 - Slide the accessories over the wires in the correct order.
- 5.4.5 Assemble the grommet onto the rear of the insulator, ensuring that the recess on the grommet aligns with the corresponding raised section on the insert.



- 5.4.6 Tuck the grommet in between the connector shell and the insert until the shoulder on the grommet is pushed almost level with the top of the serrations on the shell. A simple tool is available to help when tucking the grommet into position.

Hint: If you push forward on the back face of the grommet it should not buckle. If it does then the grommet has not been tucked into position correctly. This can cause the grommet to tare when the backshell is assembled and could affect sealing.



- 5.4.7 Locate the required wire and feed it partially through the grommet. **Note:** It is best practice to work from one side only, inserting from left to right or top to bottom in an orderly fashion. Some arrangements have a radial pattern where working from the centre and working outwards is best. Randomly inserting contacts is more likely to result in wiring errors and difficulty inserting contacts.
- 5.4.8 Open the “Tweezers-type” insertion tool and close it around the crimp bucket of the selected contact, ensuring that the wire does not pinch the wire as the tool closes. Holding the tool as close to the bucket as possible, apply a firm and even pressure, inserting the contact into the insert until it clicks into place. When inserting a socket contact it is good practice to place a

socket guide pin in the front of the contact to prevent any rubber from the grommet web entering the socket contact.

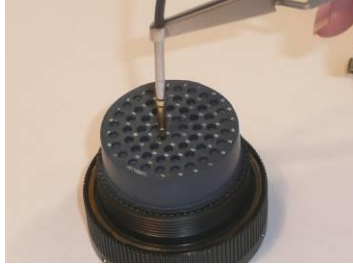

5.4.9 Slide the tool out and remove the tool from the wire.

Hint: When sliding the tool out lightly apply tweezers action to the open the tool. This will help prevent chafing the wire insulation on the tool.

Hint: As each contact is inserted pull firmly on the cable to ensure that the contact has seated correctly. Any contact not seated correctly will pull back. If this happens use the insertion tool and reinsert the contact and repeat the pull test.

5.4.10 Repeat steps 5.5.8 to 5.5.9 for all wires.

5.4.11 Checking the dimensions shown in Appendix B will verify that the contact is seated correctly. As an extra final visual check, all contacts should be around the same height with no visible differences in height from insert face.

5.4.12 Assemble the rear backshells and accessories following steps 5.4.8 to 5.4.11.

6 CONTACT EXTRACTION

6.1.1 The extraction tool can be utilised for both the size 16 and 12 contacts, by replacing the probe with the appropriate size. These probes can become damaged over time and therefore can be easily replaced. See Appendix A for details of the replacement probe part numbers.

6.1.2 Loosen cable accessory and backshell. Slide these down the cable to allow easy access to the rear of the connector. Slide the grommet and cable idents back approximately 70mm.



- 6.1.3 Working from the front face of the connector, position the extraction tool over the pin or socket contact. Carefully rotate the tool until the 3 slots in the tool align with the 3 ribs in the insert cavity. Push the tool firmly into the insert closing the clip with the front collar.



- 6.1.4 Release the contact by pushing forward on the tool handle until a click can be heard. The contact is now released.



- 6.1.5 Lightly pull on the cable to extract the contact from the insert cavity. Repeat steps 7.1.4 to 7.1.5 as required.



- 6.1.6 At this stage contacts can be cut off and replaced or pushed back through the grommet to allow the contacts to be repositioned into a different hole. **Important Note** To prevent damage to the grommet when pushing the contact through the grommet hole, use the Grommet extraction tool.

- 6.1.7 Simply place the contact fully into the tool into the tool. Using the tool push the contact through the grommet until the end of the tool is visible at the other end. Remove the contact from the tool.

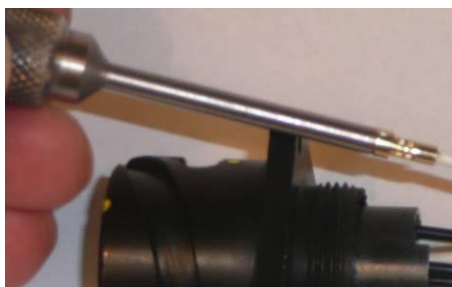

- 6.1.8 Repeat steps 6.1.3 to 6.1.7 as required. Re-insert the contacts into the connector following steps 5.4.1 to 5.4.4 as required.
- 6.1.9 **NOTE** Contacts can be extracted 30 times with out degradation to performance. Once 30 extractions have been performed it is recommended to change the contact.

7 SCREEN TERMINATION SYSTEM

- 7.1.1 Termination of shielded cables is necessary to provide R.F.I. or E.M.I. shielding protection. The CIRP Connector series has various methods for attaching shield braid to the connector backshell.
- 7.1.2 This section details assembly methods using four different backshell styles. They will be described as Method -A, B, C & D.
- 7.1.3 The following items are required to complete the assemblies.
- 7.1.4 **Braid Sock:** Provides the overall screen and is secured to the connector backshell and the interwoven knitted mesh at the opposite end.

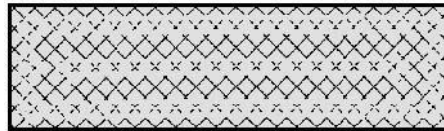

Typical Braided Sock

Connector Shell Size	Part Number	Length/Diameter
Up to shell size 32	CIRBMBS035015	150mm / 35mm
Shell sizes 36 & 40	CIRBMBS05015	150mm / 50mm

Braided Sock Lengths

Note. Make certain the sock is expanded to the correct diameter before cutting to length. To aide this operation, the use of an inner storage tube of the appropriate diameter is recommended.

- 7.1.5 **Knit Mesh:** Interwoven between individual cable screens. Ensures all screens are interconnected. Braid sock terminated to this component.

Part Number	Length	
ABBMKM1050	500mm	

Knitmesh

7.1.6 **Stainless Steel Locking Securing Band:** Used to terminate outer overall screen to backshell and interwoven knitted mesh.

Connector Shell Size	Part Number	
Up to shell size 32	CIRB600052	
Shell sizes 36 & 40	CIRB600090	

Shell Size with Securing Band

7.2 Method: A: Termination Procedure For In-line Wire Bundles

Method A uses two stainless steel securing bands that concentrically close to mechanically grip and electrically terminate the overall shield to:-

- The connector backshell, (RFI / Heat Shrink Adaptor)
- The wire bundles or multi-core cables.

7.3 Procedure for a Fixed Connector with (SCHSA)

7.3.1 Cut the braid sock to the required length and remove inner storage tube. Fold one end of the Braidsock back inside itself by approximately 15 to 20mm. as shown right.
This provides a clean edge without sharp sections.

7.3.2 Slide sock over threaded portion of RFI Adaptor.

7.3.3 Terminate braid sock to the RFI adaptor, using a securing band in Appendix C.

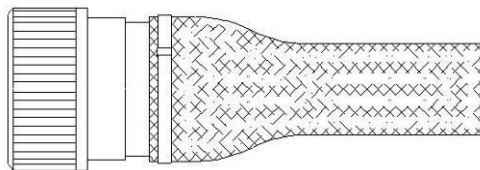
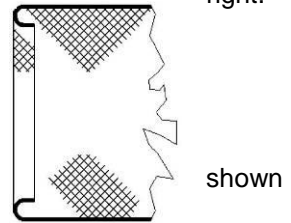

Termination of Braid Sock To RFI Adaptor

- 7.3.4 Strip cable outer insulation exposing the screen for a length of 70mm, and trim off all of this exposed screen.
- 7.3.5 Strip the cable outer insulation to a length of 170mm from the end of the cable, as shown below; which then gives a braid length of 100/125mm.

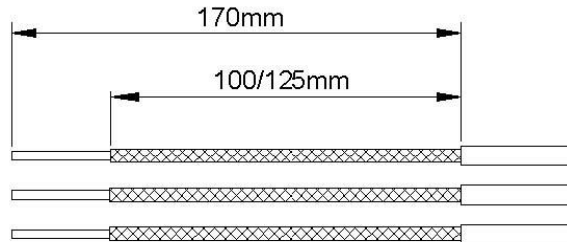

SCHSA Insulation Strip Lengths

- 7.3.6 Crimp the contacts on, load the connector and assemble the grommet as per the instructions on pages 7 to 11 inclusive.

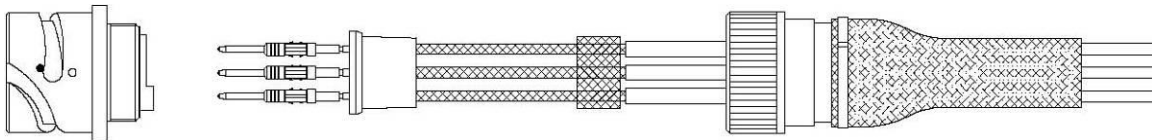

Installation of Contacts Through Grommet

- 7.3.7 Interweave the knitted mesh either between each individual cable screen or around each multi-core outer screen, and finally around the outside of the wire bundle. This should be over the braid, near the insulation, as shown on the previous page.
- 7.3.8 Secure the knitted mesh with an appropriate tinned copper wire.
- 7.3.9 Slide braid sock / RFI adaptor assembly forward over grommet and screw the adaptor on to the connector. Take care to ensure correct seating of the grommet. Tighten to recommended torque see Appendix D.

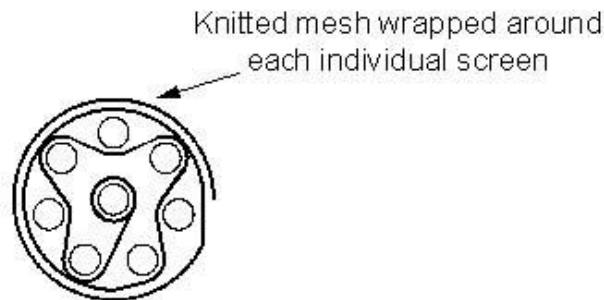

- 7.3.10 Using a suitable shell holding fixture, gently draw the braid down the wire bundle to its full length and terminate the braid over the knit mesh using the band tool as shown in appendix C.

Hint: Terminating the screen as instructed in 10 above does not allow for any remakes of the connector. To allow remakes, the wire should be pushed into the accessory and sock area before applying the band.

This also allows for a degree of linear strain relief on the wires.

- 7.3.11 Dress the whole assembly. Check the securing band for correct assembly.

- 7.3.12 Appropriate tape can be applied to protect ends of braid sock, if required. This will cover the braid if it has not been folded in on itself.

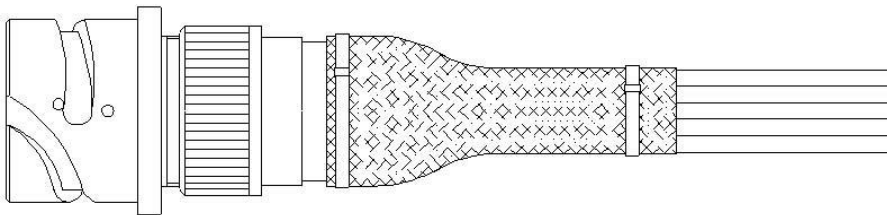

Method A - Completed

7.4 Method B: RFI Grounding.

7.4.1 Method B: allows for RFI grounding of wire bundles through 90°. It uses two stainless steel securing bands, which mechanically grip and electrically terminate the overall shield to:

- The connector backshell, (90° RFI / Heat Shrink Adaptor).
- The wire bundles or multi-core cables.

7.5 Procedure Shown Of Free Connector With ECHSA Accessory.

7.5.1 Strip cable outer insulation exposing the screen for a length of 100mm, and trim off all of this exposed screen.

7.5.2 Strip the cable outer insulation to a length of 200mm from the end of the cable, as shown.

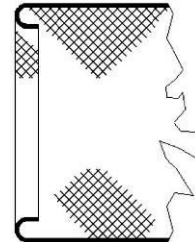
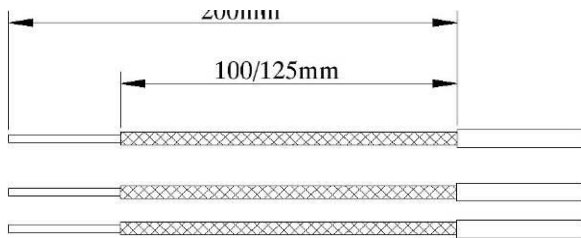

ECHSA Insulation Strip Length

7.5.3 Cut the braid sock to the required length and remove inner storage tube. Fold one end of the Braidsock back inside itself by approximately 15 to 20mm. as shown above. This provides a clean edge without sharp sections.

7.5.4 Slide the braid sock onto the cable bundle then followed by the 90° RFI adaptor.

7.5.5 Terminate the braid using the band, as detailed in Method A.

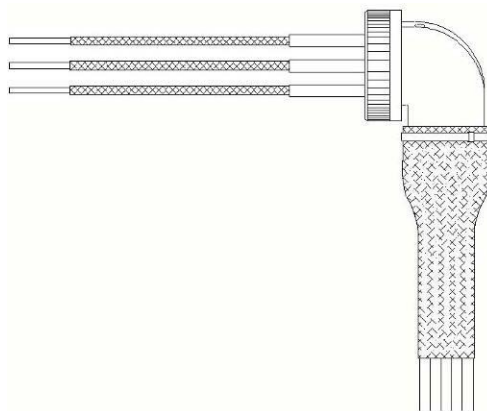

90° RFI Adaptor Over Cable Bundle

7.5.6 The later stages of the assembly are as per that detailed in Method A. i.e. crimping the contacts, securing the Knitmesh etc.

7.6 Method C: Electrical Termination

7.6.1 Method C uses two stainless steel clamp bands that concentrically close to mechanically grip and electrically terminate the overall shield to:

- The wire bundles or multi-core cables.
- Connector backshell and 'CRA' accessory, providing an interface to a conduit system.

7.6.2 The following outlines the procedure for the Fixed Connector With SCHSA & CRA Accessory.

7.6.3 Strip cable outer insulation exposing the screen for a length of 170mm.

7.6.4 Cut back the screen leaving a length of 100/125mm.

7.6.5 Crimp the contacts on, load the connector and assemble the grommet as per the instructions on pages 7 to 11 inclusive.

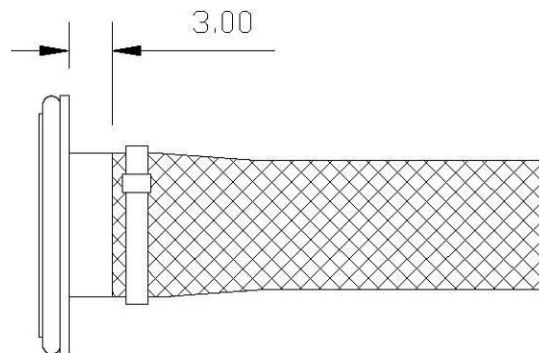

Braid Sock Assembly

7.6.6 Cut the braid sock to the required length and remove inner storage tube. Slide the braid sock over knurled section of the inner component of CRA accessory and terminate using a securing band shown in Appendix C. Ideally apply the band close to the end of the knurled section checking for a neat termination with no twisting of the band. Do not fold back braid screen when terminating braid to the CRA shell. When terminating, trim edges to produce a clean cut so as not to damage the 'O'ring seal.

7.6.7 Slide the chosen conduit assembly down the cable and away from the work area.

- 7.6.8 Assemble the connector backshell and accessory to the cable in the following order.
- . • SCHSA backshell. Ensure the 'O' ring seals are seated correctly.
 - . • CRA accessory braid sock assembly.
 - . • CRA accessory locking nut/conduit adaptor.
 - .

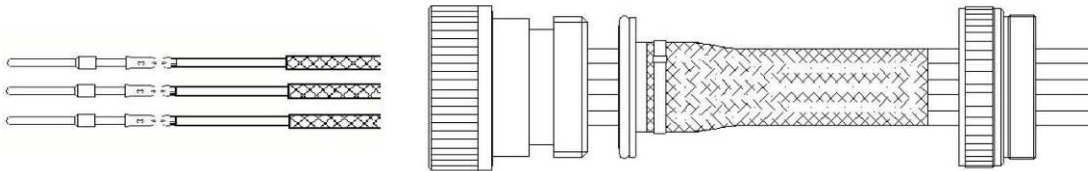

Installation of CRA and SCHSA Accessories

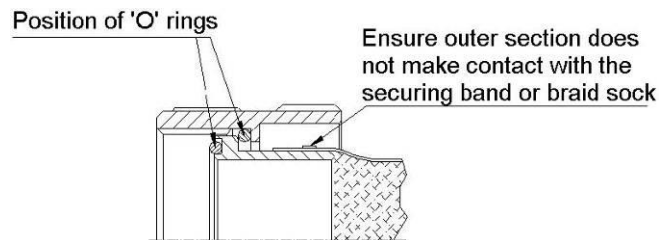

Section showing O'ring and Braided Sock Position.

- 7.6.9 Secure Knitmesh as detailed in method A.

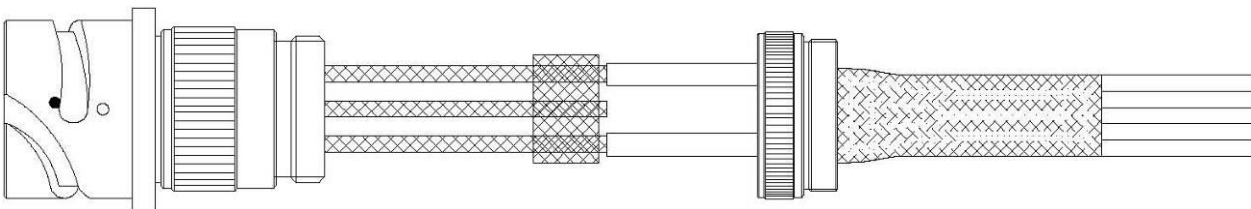

Pre-Knitmesh Assembly

7.6.10 The later stages of the assembly are as per that detailed in Method A.

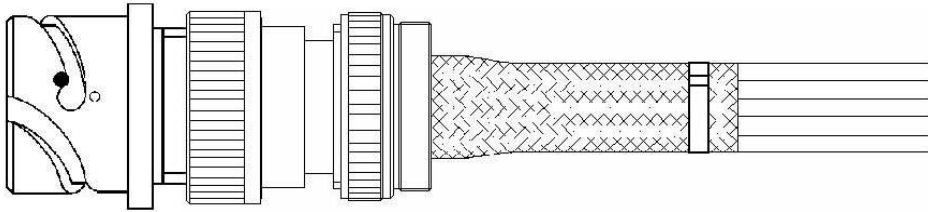

Assembled Knitmesh

7.6.11 Pull the conduit system forward over braid sock termination and secure to rear threads of the RFI / conduit adaptor.

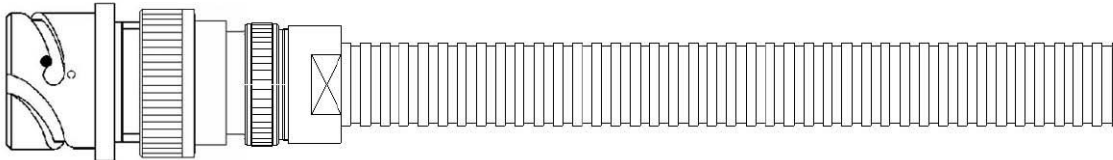

Completed Assembly

7.7 Method D: Electrical Termination (90 Degree Elbow)

7.7.1 This assembly procedure is as Method C, except for the change to a 90° connector backshell.

7.7.2 Method D uses two stainless steel clamp bands that concentrically close to mechanically grip and electrically terminate the overall shield to:

- The wire bundles or multi-core cables.
- Connector, backshell and 'CRA' accessory, providing an interface to a conduit system.

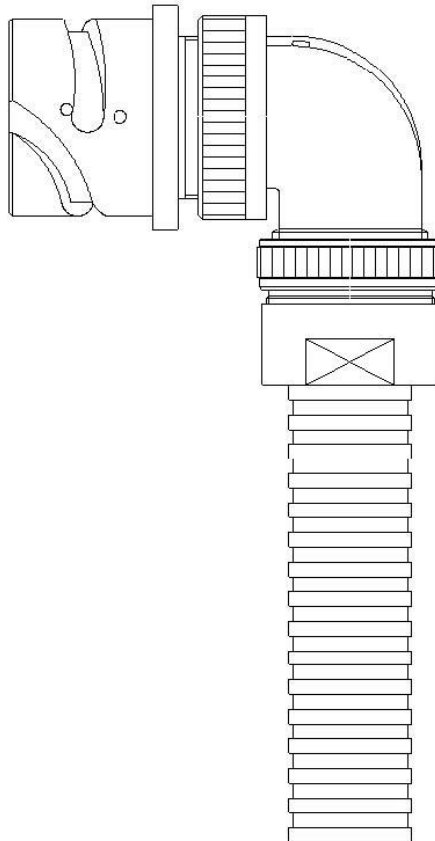

Example of finished Assembly (90° Degree Elbow)



Application Specification

5375 (08/13)
114-157001

CLASS 1-Public

Appendix A: Tooling Data

Contact Size & Type	Part Number	Wire CSA Sq.mm	Tool Setting	Crimp Tool	Turret/ Locator	Tool Position	Insertion tool	Extraction Tool	Grommet extraction tool																											
16/22 Pin	CIRP1622KPK	0.22	2	AF8/WA27F OR FT8/WA27E	TH592	Blue	P80 16 ITL	P80 16 ET	P80 16 GET																											
		0.34	3																																	
16/22 Skt	CIRP1622KLK	0.22	2			AF8/WA27F OR FT8/WA27E				TH592	Red	P80 16 ITL	P80 16 ET	P80 16 GET																						
		0.34	3																																	
16/20 Pin	CIRP1620KPK	0.50/0.75	3								AF8/WA27F OR FT8/WA27E				TH592	Blue	P80 16 ITL	P80 16 ET	P80 16 GET																	
16/20 Skt	CIRP1620KLK															Red																				
16/18 Pin	CIRP1618KPK	0,75/0,93	4													AF8/WA27F OR FT8/WA27E				TH592	Blue	P80 16 ITL	P80 16 ET	P80 16 GET												
16/18 Skt	CIRP1618KLK																				Red															
16 Pin	CIRP16KPK	0.93/1.5	5																		AF8/WA27F OR FT8/WA27E				TH592	Blue	P80 16 ITL	P80 16 ET	P80 16 GET							
																										16 Skt				CIRP16KLK	Red					
16/14 Pin	CIRP1614KPK																														1.94/2.08	5	AF8/WA27F OR FT8/WA27E	TH592	Blue	P80 16 ITL
16/14 Skt	CIRP1614KLK																									Red										



Application Specification

5375 (08/13)
114-157001

CLASS 1-Public

Contact Size & Type	Part Number	Wire CSA Sq.mm	Tool Setting	Crimp Tool	Turret/ Locator	Tool Position	Insertion tool	Extraction Tool	Grommet Extraction tool
12/20 Pin	CIRP1220KPKP80	0.50/0.75	3	FT8/W27E	TH592	Yellow	P80 12 ITL	P80 12 ET	N/A
12/20 Skt	CIRP1220KLKP80								
12/18 Pin	CIRP1218KPKP80	0,75/0,93	4						
12/18 Skt	CIRP1218KLKP80								
12/16 Pin	CIRP1216KPKP80	0.93	5						
		1.5							
12/16 Skt	CIRP1216KLKP80	0.93	5						
		1.5							
12/14 Pin	CIRP1214KPKP80	1.94/2.08	5						
12/14 Skt	CIRP1214KLKP80								
12 Pin	CIRP12KPKP80	2.50/3.00	7						
12 Skt	CIRP12KLKP80								
12/40 Pin	CIRP1240KPKP80	4	5	M310					
12/40 Skt	CIRP1240KLKP80								
12/10 Pin	CIRP1210KPKP80	4	5						
12/10 Skt	CIRP1210KLKP80								



Application Specification

5375 (08/13)
114-157001











CLASS 1-Public

Contact Size & Type	Part Number	Wire CSA Sq.mm	Tool Setting	Crimp Tool	Turret/ Locator	Tool Position	Insertion tool	Extraction Tool
100/60 Pin	CIRBP10060KPKP80	6	N/A	D55E/D51	MRP31038	N/A	N/A	P80 8 ETA
100/60 Skt	CIRBP10060KSKP80							
100 Pin	CIRBP100KPKP80	10			MRP0925			
100 Skt	CIRBP100KSKP80							
8/40	CIRBP8/40KPKP80	4						
8/40	CIRBP8/40KSKP80	4						
8/16	CIRBP8/16KPKP80	0.93/1.50	Consult Factory	M310	Consult Factory	Consult Factory		
8/16	CIRBP8/16KSKP80	0.93/1.50						
8	CIRBP8KPKP80	9	N/A	ERMA19600	22390	N/A		
8	CIRBP8KSKP80	9						

Table of P80 Contact Tooling Data

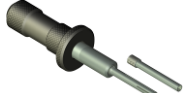



Tooling guide

Main tools (Required)

Photo	Description	Part number	Use
	Hand Crimp tool	AF8 OR FT8	FT8 Crimping contacts sizes 16 and 12. AF8 Crimping contacts sizes 16 only.
	Pneumatic crimp tool	WA27F or WA27E	WA27E Crimping contacts sizes 16 and 12. WA27F Crimping contacts sizes 16 ONLY Alternative to AF8/FT8
	Turret Locator	TH592	Locating contacts in crimp tool
	Hand crimp tool	D51	Crimping size 100 contacts
	Electric crimp tool	D55E	Crimping size 100 contacts. Alternative to D51
	Die sets	Various see crimping table	Crimping size 100 contacts
	Insertion tool	CIR80 16 ITL CIR80 12 ITL	Inserting contact into the plastic insert
	Extraction tool (Contains slotted and solid front sections)	CIR80 16 ET CIR80 12 ET	Extracting contact from the plastic insert
	Extraction Tool Replacement Fronts Pack of 2. Slotted and Solid	CIR80 16 ETSA CIR80 12 ETSA	Replacement front sections
	Extraction tool front individual <u>Slotted</u>	CIR80 16 ETS 2 CIR80 12 ETS 2	Replacement front sections
	Extraction tool front individual <u>Solid</u>	CIR80 16 ETS 3 CIR80 12 ETS 3	Replacement front sections
	Extraction tool	CIR80 8 ET A	Extracting contact from the plastic insert

	Grommet extraction tool	CIR80 16 GET	To allow extraction of contact back through the grommet without damaging sealing feature.
---	-------------------------	--------------	---

Supplementary tooling

Photo	Description	Part number	Use
	Contact retention tester	HT250-3	Applies a load to the front of the contact to ensure it is seated correctly.
	Contact pin retention test probe	68 016 01 (size 16) 68 012-01 (Size 12)	Fits onto contact retention test probe to test socket contacts
	Contact socket retention test probe	67 016 01 (Size 16) 67 012 01 (Size 12)	Fits onto contact retention test probe to test socket contacts
	Pin Contact alignment gauge	CIR80 ## CAG (Where ## = size and platform e.g. CIR80 2821 CAG)	To check that contacts have not bent during assembly, tool also straightens bent pins

Appendix B: Dimensional Positions of Contacts in fixed and free Shells.

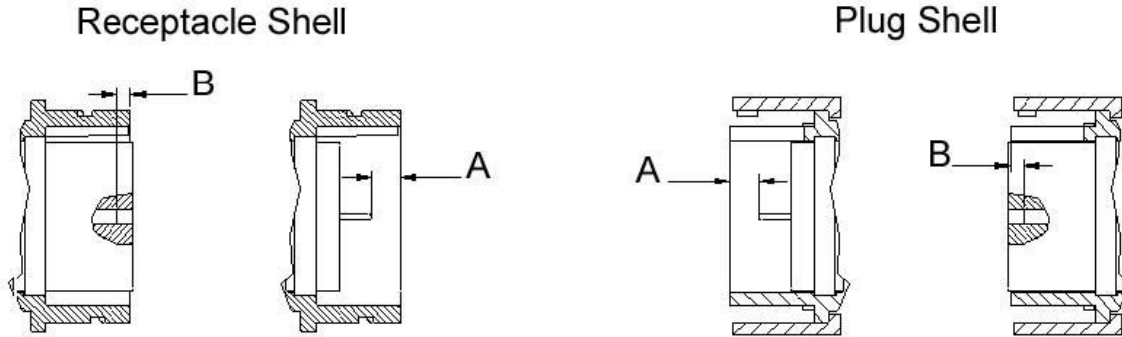

Dimensional Position of Contacts in Fixed & Free Shell Arrangements

Note: All dimensions in millimetres (mm)

Shell Size	Pin 'A'		Socket 'B'
	Contact Size		Contact Size
	16	12	16 & 12
	+1.0	+1.0	+1.0
	-1.0	-1.0	-1.0
18	6,6	3,0	2,6
20	6,6	3,0	2,6
22	6,6	3,0	2,6
28, 32	6,6	3,0	2,6
36, 40	6,6	3,0	2,6

Table Position of Contacts

Appendix C: Guidance for the use of 90° Backshells

It is important when specifying connector backshells that the correct backshell is used according to the application and cable routing. If the correct backshell is not used it could cause damage to the cables and put undue stress on the contacts. This in turn could affect its performance or shorten the service life of the connector.

When routing cables through a 90° bend behind the connector. It is important to use a 90° outlet for this purpose.

While it is recommended that a 90° outlet is used in all such applications. This document provides a guide to the minimum bend that can be applied to a cable without the use of the correct backshell.

The bend radius shown is through the centre of the connector body.

It is important to note that the bend radius shown is for the connector in it's uncoupled state as when the connector is uncoupled it reduces the bend radius of the cables.

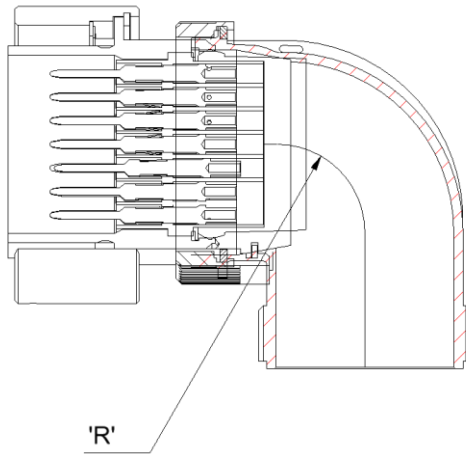

Shell Size	Minimum Recommended Bend Radius "R"
18	10mm
20	10mm
22	10mm
24	15mm
28	15mm
32	20mm
36	25mm
40	30mm

Appendix D: Torque Backshell Values.

Shell Size	Backshell to Connector Tightening Torque (Nm)	Torque values are required to achieve screen continuity and sealing on RFI accessory (Methods C & D). Accessory part number ABB**CRA.
18	12.3	5.3
20	12.3	7.0
22	12.3	7.0
28	12.3	8.0
32	14.9	10.5
36	17.5	11.4
40	22.0	13.2

Table of Backshell Torque Shell Values

The above values are based upon the most densely populated contact arrangements with cables at the maximum limit for the grommet. The values are to be used for guidance only.

As a guide, tighten the accessory up enough, so that the accessory is firmly in place and cannot be rotated.

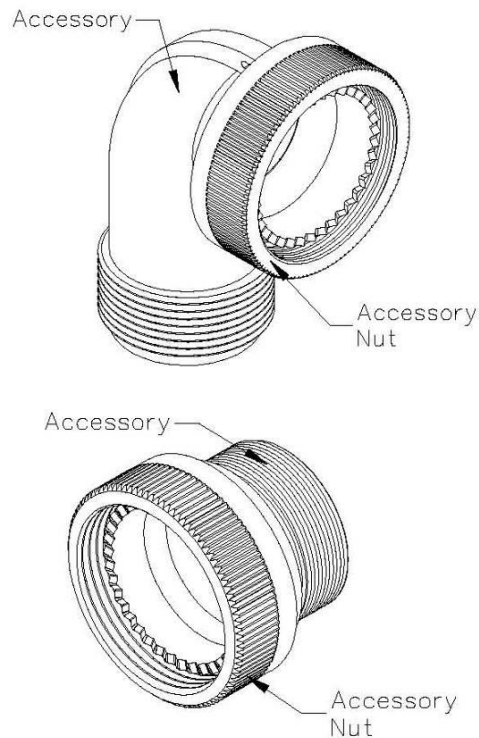

Typical Accessory Nuts

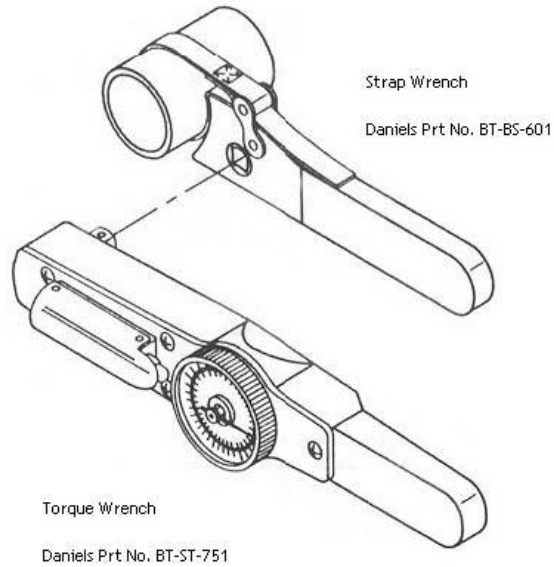

Typical Torque and Strap Wrench.

Appendix E: Steel Band Termination Assembly Process

Hand Banding Tool -TE Part No. -CIRB600058

Prepare the band in the following manner: **IMPORTANT:** Due to the connector / adaptor circumference, it may be necessary to prepare the band around the cable retention area.

Roll band through the buckle slot **twice**.

Pull on band until mark (>|) is within approximately 6.4mm of the buckle slot. the band may be tightened further if desired.

Note: prepared band should have mark (>|) visible where approximately shown.

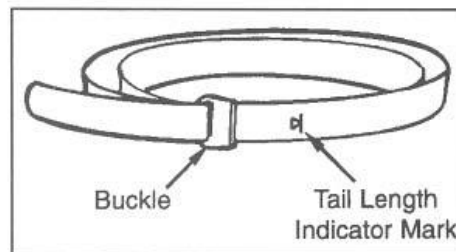

Hand Banding Tool Step 1

Squeeze gripper release lever and insert band into the front end of the opening of the tool.

Important: The straight leg of looped band is to be installed with the circular portion of looped band facing downward towards the black handle.

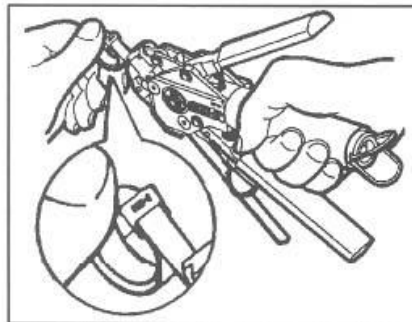

Hand Banding Tool Step 2

Aligning the band and the tool with the shield termination area, squeeze black, pull-up handle repeatedly until it locks against the tool body. (This indicates the band is compressed to the pre-calibrated tension).

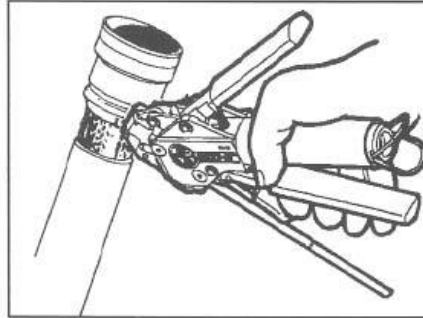

Steel Banding Tool Step 3

Complete the clamping process by squeezing the grey cut-off handle.

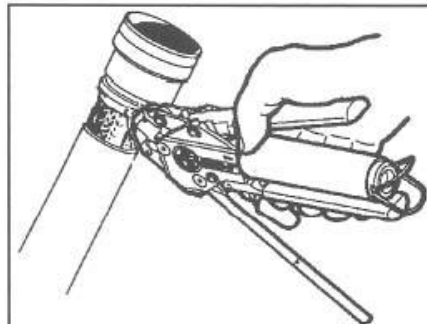

Steel Banding Tool Step 4

Remove excess band from the tool and inspect shield termination.

Appendix F: Trouble Shooting.

Symptom:	Common Cause:	Solution:
Uneven contact heights in the connector	The contact is not fully inserted in the insulator. However there is a small amount of movement, which is acceptable when the contact is correctly seated.	Using the appropriate contact insertion tool, reapply pressure to fully locate the contact. If the problem persists, remove the contact and inspect the retaining clip for damage.
Connector un-couples in use.	Connectors not fully coupled.	Rotate the coupling nut until an audible 'snap' is heard and the coloured dots on the fixed and free shells are aligned. Depending on the size of the mating connectors, a mechanical device like a strap will ease the final stage of the coupling operation.
Poor crimp performance, e.g. low cable pull out forces; high resistance etc..	Incorrect crimp tool settings or conductors cut during the stripping operation.	Use correctly calibrated tools and settings. Adjust the stripping tool depth so that only the insulation is cut.
Contacts short to shell or across contacts.	1. Foreign objects between insulator and grommet or connector faces. 2. Water Ingress.	1. Check for swarf or conductor strands on connector faces. 2. Dry out the connector, check the grommet and retighten the backshell to the specified torque value.
Water Ingress to Backshell	1. No grommet. 2. Incorrect cable for grommet. 3. Loose backshell/accessory 4. Grommet damaged during contact insertion. 5. Grommet not seated correctly.	1. Fit Grommet. 2. Build-up insulator diameter 3. Check for grommet/damage. 4. Tighten to specified value. 5. Reseat grommet fully.
Securing band will not hold the screen	Band only wrapped around once before tightening.	Wrap the band twice around the backshell before tightening.
Contacts push back when connectors are mated	1. Contacts not fully inserted 2. Attempting to couple connectors with different insulator orientations 3. Contacts bent. 4. Retention clip damaged during extraction.	1. Using the appropriate contact insertion tool, re-apply pressure to fully locate the contact. 2. Check orientations before mating. 3. Replace bent contacts. 4. Replace clip or contact. 5. If a push back occurs prior to connector mating (during push back check) then it is certain that the contact was not fully locked into position and can be simply pushed forward until it is locked. 6. If a push back contact occurs post connector mating, then it is not certain why the failure occurred, so the plastic insulator should be replaced in case any damage has occurred to the plastic. In addition, the contact should be checked for signs of damage, particular attention should be given to the retention legs. If the contact is damaged then it should also be replaced.

Connectors will not mate	<ol style="list-style-type: none"> 1. Attempting to couple connectors with different insulator orientations 2. Contacts bent or damaged. 3. Socket contact clips damaged. 	<ol style="list-style-type: none"> 1. Ensure the connectors are the same orientation. Check coloured identification band. 2. Check contacts for signs of damage 3. Check socket contact clips for signs of damage.
High resistance, intermittent or no contact	<ol style="list-style-type: none"> 1. Socket contact clips missing. 2. Poor crimp joints. 3. Wire broken or damaged. 	<ol style="list-style-type: none"> 1. Check contact for missing clip. 2. Check crimp and crimp tool settings 3. Check wire for signs of damage including very tight bend radii.
Problem locking the backshell to the plug connector	Connector difficult to grip due to rotating coupling nut.	Mate the plug connector to a suitable fixture prior to tightening.