

CIRH Series

Circular Multi-pin Electrical Connectors

Assembly and Wiring Instructions

PRJ-15-000001392

THIS IS A CLASS 1 DOCUMENT WHICH IS NONCONFIDENTIAL.

The information contained within this document is the property of TE Connectivity. It is supplied in confidence and the commercial security of the contents must be maintained. It must not be used for any purpose other than that for which it is supplied nor may any information contained in it be disclosed to unauthorised persons. It must not be reproduced in whole or in part without obtaining written permission from TE Connectivity (TE).

While TE has made every reasonable effort to ensure the accuracy of the information in this catalog, TE does not guarantee that it is error-free, nor does TE make any other representation, warranty or guarantee that the information is accurate, correct, reliable or current. TE reserves the right to make any adjustments to the information contained herein at any time without notice. TE expressly disclaims all implied warranties regarding the information contained herein, including, but not limited to, any implied warranties of merchantability or fitness for a particular purpose. The dimensions in this catalog are for reference purposes only and are subject to change without notice. Specifications are subject to change without notice. Consult TE for the latest dimensions and design specifications.

*Trademark. TE Connectivity, TE connectivity (logo), and TE (logo) are trademarks. Other logos, product and/or company names may be trademarks of their respective owners.

Table of Contents

1 PRODUCT INTRODUCTION3

 1.1 General.....3

 1.2 Typical Connector4

 1.3 Standard Data4

2 CONNECTOR DESCRIPTION AND TERMINOLOGY5

 2.1 The CIRH Plug Connector5

 2.2 The CIRH Receptacle Connector6

3 INDIVIDUAL WIRE TERMINATION7

 3.2 Installation of Contacts8

4 SCREENED TERMINATION SYSTEM 12

 4.2 Method: A: Termination Procedure For Receptacle Connects With In-Line Wire Bundles. 12

 4.3 Method: B: Grounding Of Wire Bundles..... 15

 4.4 Method: C: Electrical Termination..... 16

 4.5 Method: D: RFI Grounding. 19

 4.6 Method: E: RFI Grounding of Multi-Core Cable..... 20

 4.7 Method: F: Electrical Termination with Clamping Backshell 22

Appendices

APPENDIX A. CRIMP AND TOOLING DATA..... 24

APPENDIX B. POSITION OF CONTACTS 31

APPENDIX C. STEEL BAND TERMINATION ASSEMBLY PROCESS..... 32

APPENDIX D. TORQUE BACK SHELL VALUES 34

APPENDIX E. TROUBLE SHOOTING 36

1 PRODUCT INTRODUCTION

1.1 General

- 1.1.1 The CIRH connector series is based on the MS series of connectors conforming to MIL-C-5015 specification. They are interchangeable with all corresponding MS types and feature identical panel mounting dimensions.
- 1.1.2 Designed to operate within a temperature range of -55°C to +190°C, the connector also meets the mechanical and environmental ratings of BS9522 F0032 and VG95234.
- 1.1.3 The CIRH connector series incorporates a 3-pin bayonet lock coupling mechanism. The coupling is achieved by stainless steel bayonet pins of rollers riding along the three cam-tracks machined into the receptacle shell and coupling integrity is guaranteed by: Firstly having three stainless steel pins at the critical wear points of the receptacle shell cam-tracks and secondly, by positive lock indicators in the form of
 - 1.1.4 An audible click when fully mated.
 - 1.1.5 Coloured dots on both connector halves align when the connector is fully mated.
 - 1.1.6 The CIRH connectors are available in 13 shell sizes from 10sl to 49 with
 - 1.1.7 Arrangements have 1 to 85 contacts.
 - 1.1.8 High Current and Temperature versions are also available on request.
 - 1.1.9 Contacts are available in sizes 20(10), 16s(15s), 16(15), 12(25), 8(100), 4(160) & 0(500), for AWG or (Metric) cables and crimp or solder versions. VG/BS and F80 styles are available.
 - 1.1.10 Contact arrangement angular orientation is available for occasions where like connectors are in close proximity and cross mating has to be avoided.
 - 1.1.11 The dynamic sealing ring guarantees high reliability and anti-vibration characteristics and the stainless steel pins at the critical wear points.
 - 1.1.12 A nylon follower ensures that the grommet does not rotate during accessory assembly, therefore preventing wire damage.
 - 1.1.13 In summary, the CIRH bayonet coupling connector offers several advantages to the user.
 - 1.1.14 Rapid coupling and uncoupling through 120° rotation of the coupling nut.
 - 1.1.15 Vibration resistant-loosening of the coupling nut under vibration or shock condition is prevented.
 - 1.1.16 Unaffected by contaminants such as dust, sand, mud etc.
 - 1.1.17 Audible click and a visual alignment of the coloured dots provides for added security when coupling.
 - 1.1.18 Waterproof connector assemblies.

1.2 Typical Connector

Receptacle

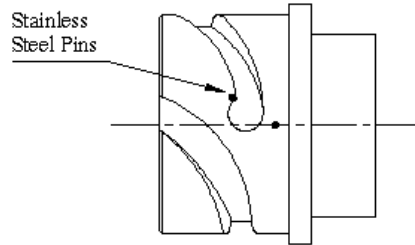
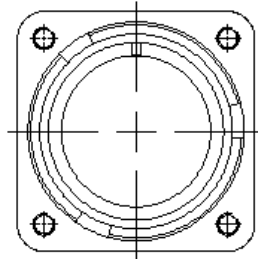

Plug

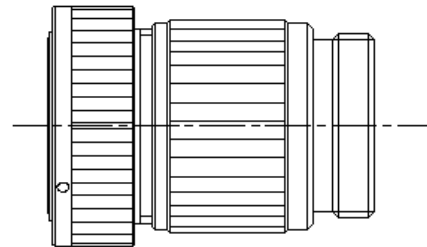
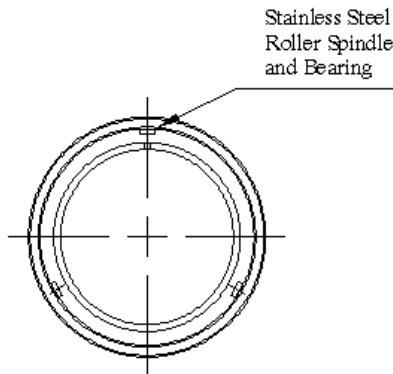

Figure 1. Typical Mating Connectors

1.3 Standard Data

1.3.1 Materials

Shell:	Aluminium Alloy
Insulator:	Polychloroprene or Low Halogen
Grommet:	Polychloroprene or Low Halogen
Contacts:	Brass Alloy
Accessory:	Aluminium Alloy

1.3.2 Plating Finishes

Shell:	Zinc or Zinc cobalt and Black Passivate or Olive drab chromate over cadmium plate.
Contacts:	Gold over nickel or hard silver over nickel
Accessory:	Zinc or Zinc cobalt and Black Passivate or Olive drab chromate over cadmium plate

1.3.3 Environmental Ratings

Shock:	75g
Vibration:	5 to 1000 Hz long endurance, 30-hour test at 10g
Acceleration:	50g
Humidity severity:	H6 (6 cycles acc. 56 days)

2 CONNECTOR DESCRIPTION AND TERMINOLOGY

2.1 The CIRH Plug Connector

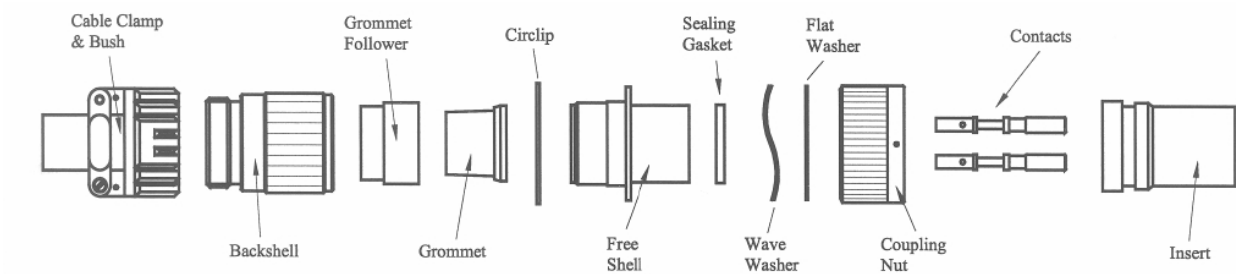

Figure 2. Exploded View of a Typical 'Plug' Connector

- 2.1.1 **Free shell** - Holds the insert.
- 2.1.2 **Insert** - Bonded into the free shell (non-removable) and retains the contacts.
- 2.1.3 **Contacts** - Crimped or soldered to the conductors.
- 2.1.4 **Sealing gasket** - Square section gasket seals the free shell to the receptacle interface when the connectors are mated.
- 2.1.5 **Wave washer** - Ensures RFI grounding when connectors are mated.
- 2.1.6 **Coupling nut** - Provides cam force when mating and un-mating connectors. Front removable.
- 2.1.7 **Circlip** - Retains coupling nut.
- 2.1.8 **Grommet** - Resilient rubber seal for individual wire terminations.
- 2.1.9 **Grommet follower** - Nylon cone, which compresses the grommet to seal individual conductors and prevent cable rotation during backshell assembly.
- 2.1.10 **Backshell** - Accessory, which screws onto the rear of the plug or receptacle, shell and provides an interface for the other accessories. The backshell contains the wire terminations and holds the grommet and the follower in position. A wide variety of backshells are available.
- 2.1.11 **Cable clamp** – Accessory, which screws onto a backshell, provides cable jacket strain relief for individual conductor bundles.

2.2 The CIRH Receptacle Connector

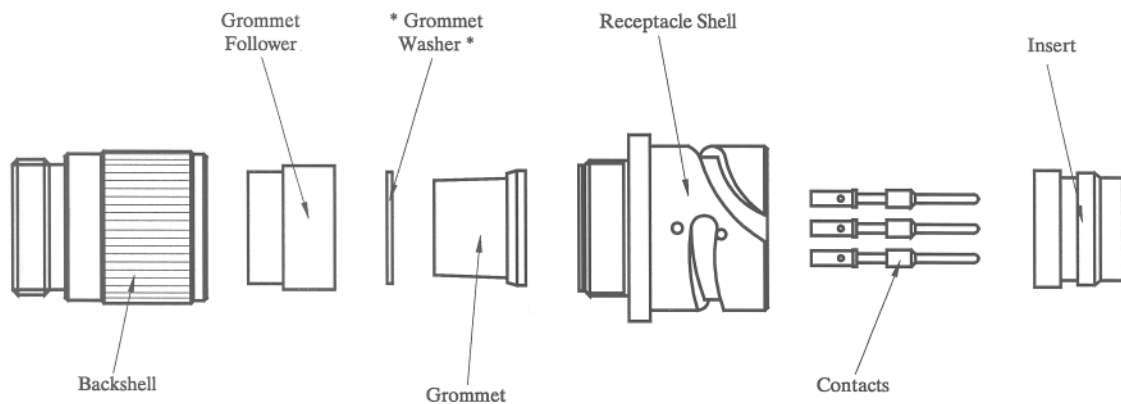

Figure 3. Exploded View of a Typical 'Plug' Connector

- 2.2.1 The Receptacle shell, a fixed half of a connector pair, holds the insert. Coupling ramps provide cam action for coupling and un-coupling. Stainless steel pins at the top of the ramps ensure positive locking and long service life.
- 2.2.2 **Insert-** bonded into the fixed shell (not removable). Retains the contacts.
- 2.2.3 **Contacts-** crimped or soldered to the conductors.
- 2.2.4 **Grommet-** resilient rubber seal for individual conductor terminations.
- 2.2.5 **Grommet washer-** to be used on rear mounted receptacles only.
- 2.2.6 **Grommet follower-** nylon cone compresses grommet to seal individual conductors and prevent cable rotation during Backshell assembly.
- 2.2.7 **Backshell-** accessory, which screws on the rear of the plug or receptacle shell. Contains the conductor terminations and holds the grommet and grommet follower in place. A wide variety of Backshells are available.

3 INDIVIDUAL WIRE TERMINATION

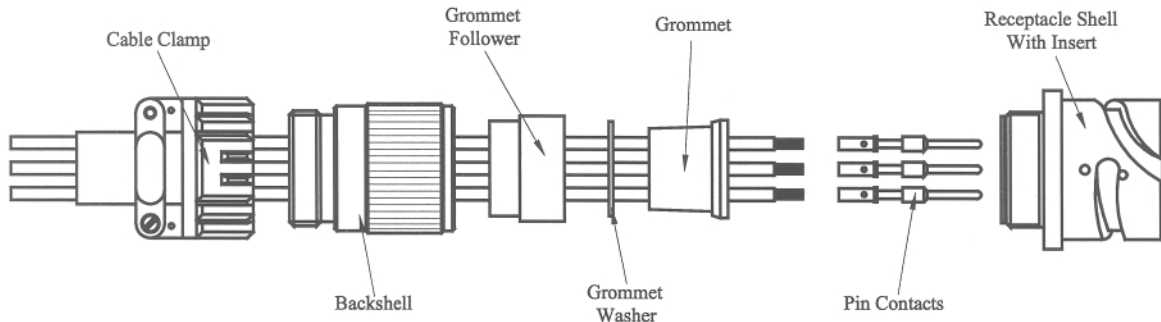

Figure 4. Individual Wire Termination Procedure (Shown on Receptacle Connector)

- 3.1.1 Slide the connector components onto the cable in the order shown above. Pass the wires through the grommet before stripping and crimping operations. **Important:** pass individual wires through the grommet in the same orientation, as they will be installed in the insert after crimping contacts.

Note: If a cable clamp is required, check the sealing range is correct for the wire bundle. (Bushes may be nested to provide the correct fit to cables if required).
- 3.1.2 Strip ends of the wires as per the chart on page 8.
- 3.1.3 Crimp the contacts onto the wires following the instructions on page 9.
- 3.1.4 Hold the receptacle flange firmly or if a vice is used, cushion the vice jaws to prevent damage to the connector finish. If assembly is performed with a plug connector, mate with a receptacle shell to hold in the vice. Blank receptacle shells can be obtained from TE Connectors for this purpose.

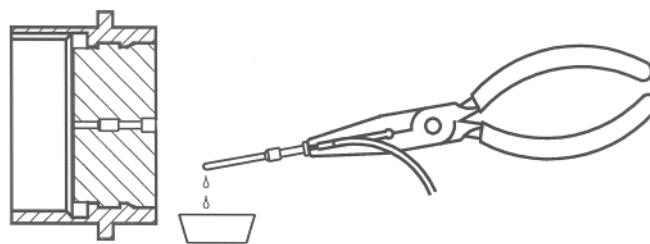

Figure 5. Lubricate Contact

- 3.1.5 Lubricate contact by dipping the front into a solvent such as "Pronatur" or isopropyl alcohol.

Important: When using isopropyl alcohol "Sure Touch" gloves and barrier cream must be worn. Eye protection must be worn. If contact with eye takes place, seek immediate medical attention.

Note: Ensure the cap is placed over the spout of the isopropyl alcohol when not in use. Tin to be returned to shop store when not in use.

3.2 Installation of Contacts

- 3.2.1 Using the prescribed insertion tool (see Appendix A, push the contacts into the correct cavity from the rear of the connector as shown above. Exert a steady pressure until the contact locks into place. Move contact back and forth slightly to ensure correct seating.

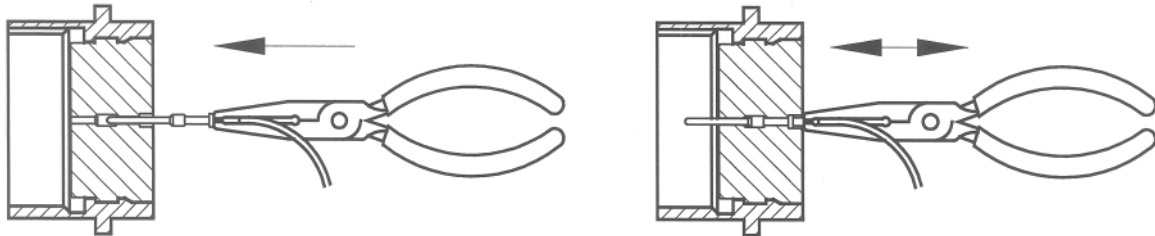

Figure 6. Contact Installation

- 3.2.2 NB. In some cases customers put the grommet onto the back of the connector, and push the contacts through the grommet and into the connector cavity. This should be avoided whenever possible as this can damage the sealing webs in the grommet.
- 3.2.3 The correct seating dimensions are as per the table in Appendix B. Use the correct extraction tools to reposition contacts if inserted too deeply.
- 3.2.4 Important: When installing size 12 or smaller female contacts, guide pins should be used to ease entry and prevent shaving of the shoulders in the insert.

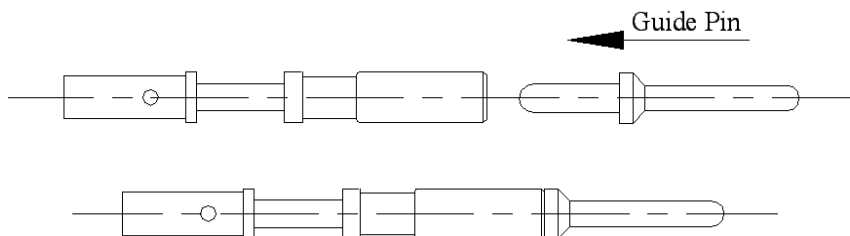

Figure 7. Use of Guide Pin with Socket Contact

- 3.2.5 Empty contact cavities must be filled using **contacts or dummy contacts** (see page 9). Empty wiring cavities in the **grommet** must be filled with **grommet filler plugs to ensure sealing**.
- 3.2.6 Slide the **sealing wire grommet** forward over the contact/wire terminations.
- 3.2.7 Slide the **grommet follower** forward over the rear of the grommet.
- 3.2.8 Slide the **back shell** forward and screw onto the rear of the free/fixed connector shell. Tighten to specified torque value. (See Appendix C)
- 3.2.9 If used slide the **cable clamp** forward and screw onto the rear of the Backshell.
- 3.2.10 Perform a continuity check to ensure all wires are properly terminated. Label as required.

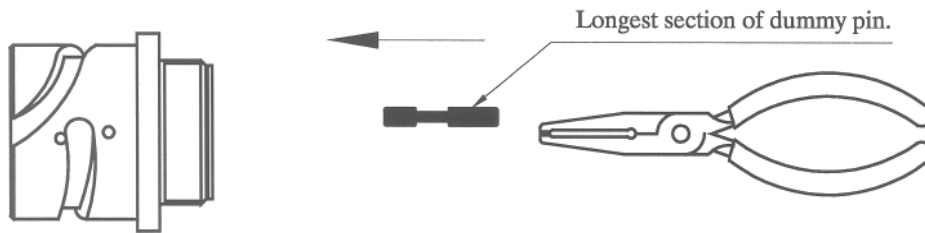

Figure 8. Dummy Contact Insertion

- 3.2.11 NB. If dummy contacts are used, then once inserted, these should be level with the standard contacts when measured at the back of the connector. Dummy contacts should never protrude out at the front of the insert.

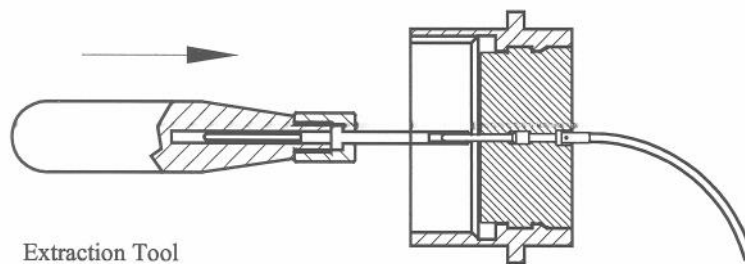

Figure 9. Extraction of Contacts

- 3.2.12 Pull back loose connector parts over cable and select the appropriate tool (see Appendix A)
- 3.2.13 Working from the face of the connector, place the tool into the socket contact or over the pin contact. See figure above.
- 3.2.14 Apply an even pressure and push the contact out of the rear of the connector.
- 3.2.15 The operation is complete when the shoulder of the tool rests against the insulator face.

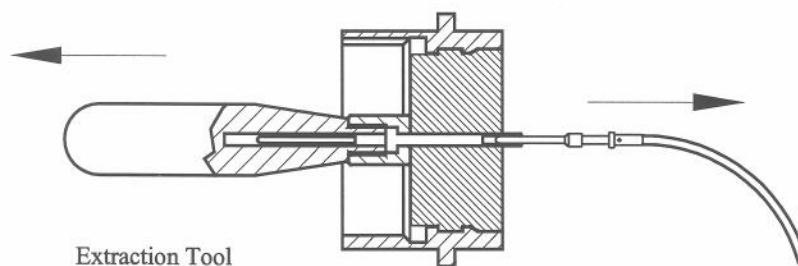

Figure 10. Extraction of Contacts

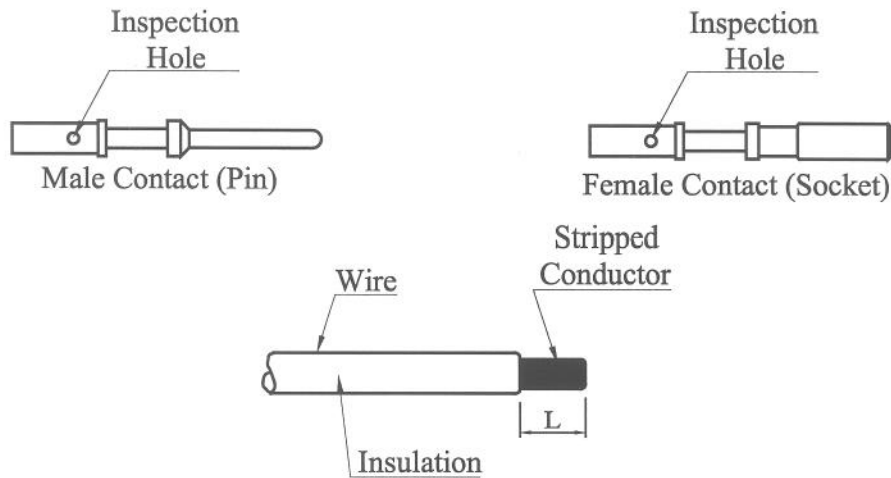

Figure 11. Stripping and Crimping Operation

3.2.16 Strip individual conductors according to table below.

Contact Size	Typical Crimp Contact part number		Dimension 'L' Conductor strip length
	Pin	Socket	
16s	CIRB-16s-KPK-#	CIRB-16s-KSK-#	6.7
16/20	CIRB-16/20-KPK-#	CIRB-16/20-KSK-#	6.7
16	CIRB-16-KPK-#	CIRB-16-KSK-#	6.7
12/20	CIRB-12/20-KPK-#	CIRB-12/20-KSK-#	6.7
12/16	CIRB-12/16-KPK-#	CIRB-12/16-KSK-#	6.7
12	CIRB-12-KPK-#	CIRB-12-KSK-#	6.7
12/10	CIRB-12/10-KPK-#	CIRB-12/10-KSK-#	6.7
100	CIRB-100-KPK-#	CIRB-100-KSK-#	12-13
8	CIRB-8-KPK-#	CIRB-8-KSK-#	12-13
160	CIRB-160-KPK-#	CIRB-160-KSK-#	12-13
4	CIRB-4-KPK-#	CIRB-4-KSK-#	12 - 13
500	CIRB-500-KPK-#	CIRB-500-KSK-#	14-15
0	CIRB-0-KPK-#	CIRB-0-KSK-#	14-15

Table 1. Conductor Stripping Lengths

3.2.17 After Stripping, leave the end of the insulation clean and square. Should the lay of the strands be disturbed, return it by a light twist.

Important: A stripped conductor with 'nicked' or cut strands is not acceptable. Ensure the conductor is clean before assembly into the contact.

- 3.2.18 Select the correct crimp tool and turret/locator for the contact to be crimped from the table in Appendix A, and install the turret/locator onto the crimp tool.
- 3.2.19 Set the correct tool setting and tool position for the contact as shown in Appendix A.
- 3.2.20 Insert the stripped conductor into the contact crimp bucket. Ensure conductor is fully pushed in and that insulation is tight to crimp bucket
- 3.2.21 Check inspection hole to see if the conductor strands are visible. If they are not visible, check the conductor strip length and check for foreign objects in the crimp bucket.
- 3.2.22 Operate the empty crimp tool once to ensure the crimping dies are completely open and there is no misalignment.
- 3.2.23 Insert the contact with the conductor installed into the contact-locating hole in the crimp tool until it 'bottoms' in the locator/turret. Applicable to size 12 & 16 only. Position the size 8 (100) and above contact so that the crimp bucket rests on the bottom jaws of the die set with the back of the contact protruding approximately 2mm over the back of the die
- 3.2.24 Activate the crimp tool through one complete cycle.
- Note.** The ratchet action on some tools will not allow contact removal mid-cycle. When crimping Size 8 Contacts and above ensure that the flats of the Hexagonal Die Set come together.
- 3.2.25 Remove the crimped assembly from the tool and inspect the joint for the correct crimp location as below.

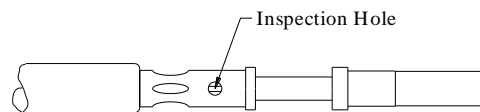

Figure 12. Crimp Joint Location

- 3.2.26 Check that the conductor strands are visible through the inspection hole.
- Important:** Loose conductor strands or cracks in the crimp area are not acceptable. The crimp joint must be re-made if there is any sign of damage.
- 3.2.27 Loose conductor strands or cracks in the contact crimp area must not be allowed.
- 3.2.28 Crimp retention forces are detailed in the relevant connector specifications. Consult TE Connectors Ltd. for information.

4 SCREENED TERMINATION SYSTEM

4.1.1 Termination of shielded cables is necessary to provide R.F.I. or E.M.I. assembly protection. The TECIR Connector series has various methods for attaching shield braid to the connector backshell.

4.1.2 This section details assembly methods using six different accessories. They will be described as Method: - A, B, C, D, E and F.

4.2 Method: A: Termination Procedure For Receptacle Connects With In-Line Wire Bundles.

4.2.1 The following method uses two stainless steel clamp bands that concentrically close to mechanically grip and electrically terminate the overall shield to: -

- The connector backshell (RFI / Heat Shrink Adaptor)
- The wire bundles or multi-core cables.

4.2.2 Cut the braid sock to the required length and remove inner storage tube. Fold one end of the Braidsock back inside itself by approximately 15 to 20mm as shown below right. This provides a clean edge without sharp sections.

4.2.3 Terminate braid sock to RFI adaptor using clamp band as per Appendix B.

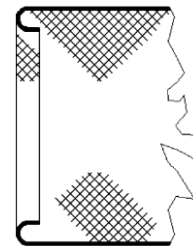
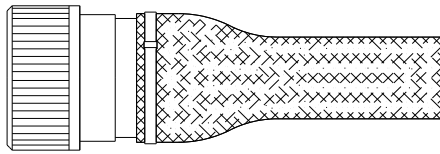

Figure 13. RFI Braid Sock

4.2.4 Strip cable outer insulation exposing the screen for a length of 70mm, and trim off all of this exposed screen.

4.2.5 Strip the cable outer insulation to a length of 170mm from the end of the cable, as shown below which then gives a braid length of 100/125mm.

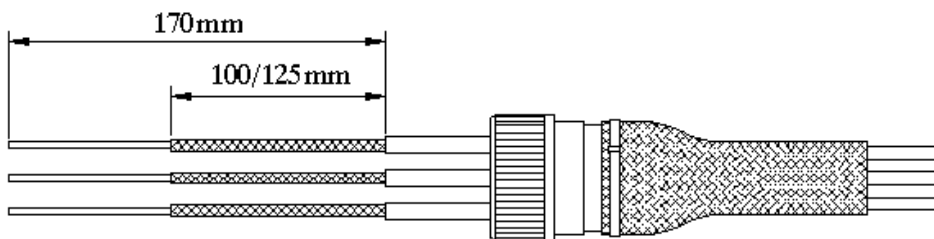

Figure 14. Insulation Cut Lengths

4.2.6 Pass individual wires through the grommet before the stripping and crimping operations, as shown.

Important: Pass the individual wires through the grommet in the same orientation, as they will be installed into the insert after crimping of contacts.

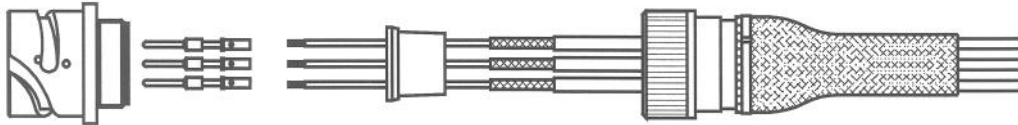

Figure 15. Installation of wires through Grommet

4.2.7 Strip ends of wires as per chart on page 8

4.2.8 Crimp the contacts on to the wires following the instructions on page 9.

4.2.9 Hold the receptacle flange firmly or if a vice is used, cushion the vice jaws to prevent damage to the connector finish.

4.2.10 Insert the contacts following instructions 1.7.5 through to 1.8.6 on pages 5 & 6.

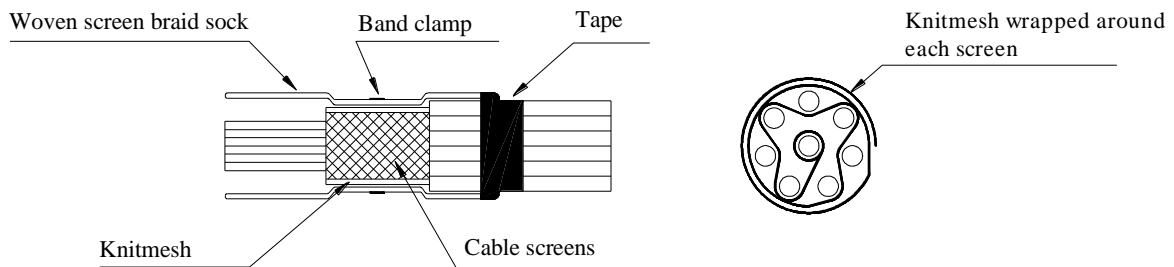

Figure 16. Installation Of Knitted Mesh Braid

4.2.11 Interweave the knit mesh braid either between each individual cable screen or around each multi-core outer screen, and finally around the outside of the wire bundle or multi-cores (see sectioned view).

4.2.12 Secure the knit mesh braid with an appropriate tinned copper wire.

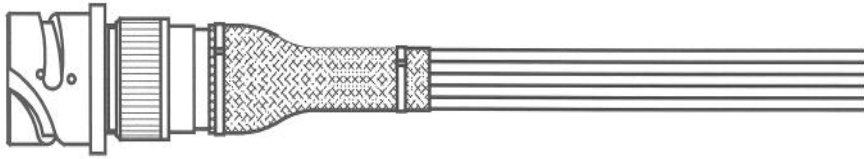

Figure 17. Final Assembly

- 4.2.13 Slide braid sock / RFI Adaptor Assembly forward over grommet and screw adaptor on to connector accessory thread. Pull back Braid Sock enabling it to be clamped as to provide strain relief on the cables.
- 4.2.14 Terminate braid sock and knit mesh braid using a clamp band. Apply appropriate tape to protect ends of braid sock. (See sectioned view). Alternatively fold sock back on itself as in "A" to provide clean edge.
- 4.2.15 This assembly caters for any rework situation at the connector, without disturbing the knit mesh / clamp band termination.

4.3 Method: B: Grounding Of Wire Bundles.

4.3.1 The following method allows for RFI grounding of wire bundles through 90°. It uses two stainless steel clamp bands that mechanically grip and electrically terminate the overall shield to: -

4.3.2 The connector backshell (90° RFI / Heat shrink adaptor) and the wire bundle.

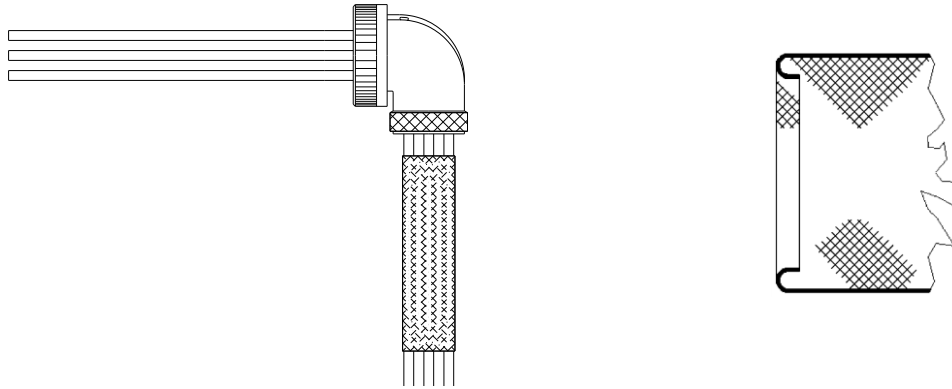

Figure 18. Slide Parts Along Cable in Correct Order

4.3.3 Cut the braid sock to the required length and remove inner storage tube. Fold one end of the Braidsock back inside itself by approximately 15 to 20mm. as shown above. This provides a clean edge without sharp sections.

4.3.4 Slide the braid sock and 90° RFI adaptor over the cable bundles or multi-cores in the correct order.

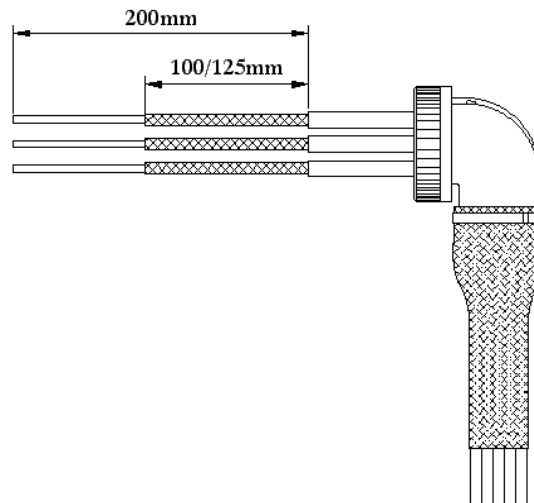

Figure 19. Screen Strip Lengths

4.3.5 Terminate braid sock to 90° RFI adaptor using clamp band as per sheet 18.

4.3.6 Strip cable outer insulation exposing the screen for a length of 100/125mm, and trim off all of this exposed screen.

4.3.7 Strip the cable outer insulation to a length of 200mm from the end of the cable, as shown above.

4.3.8 Procedure is then the same as Method A: Para 2.1.8 through to 2.1.17

4.4 Method: C: Electrical Termination.

4.4.1 The following method uses two stainless steel clamp bands that concentrically close to mechanically grip and electrically terminate the overall shield to: -

4.4.2 The connector backshell (RFI / Conduit Adaptor).

4.4.3 The wire bundles or multi-core cables.

4.4.4 Also the special backshell provides an interface to a conduit system.

4.4.5 Procedure shown on Receptacle Connector: -

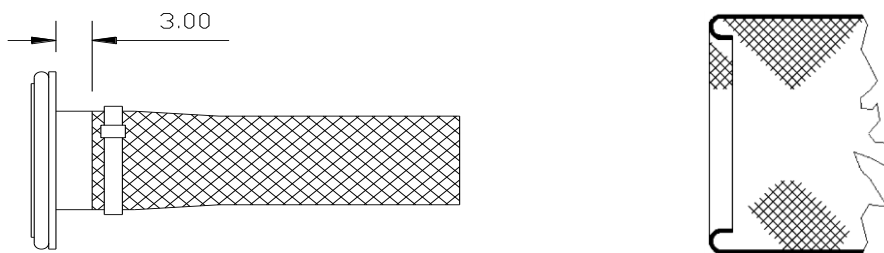

Figure 20. Termination of Braid Sock to RFI Adaptor

4.4.6 Cut the braid sock to the required length and remove inner storage tube. Fold one end of the Braidsock back inside itself by approximately 15 to 20mm as shown above. This provides a clean edge without sharp sections.

4.4.7 Terminate braid sock to RFI / adaptor using clamp band as per Appendix C. Ideally apply strap close to the end of the knurled section, ensure a neat termination with no twisting of the band.

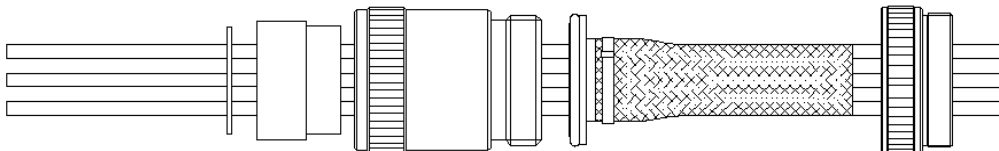

Figure 21. Slide Parts Along Cable in Correct Order

4.4.8 Assemble the connector backshell and accessory to the cable in the following order.

- CRA accessory locking nut/conduit adaptor.
- CRA accessory braid sock assembly.
- SCHSA backshell. Ensure the 'O' ring seals are seated correctly.

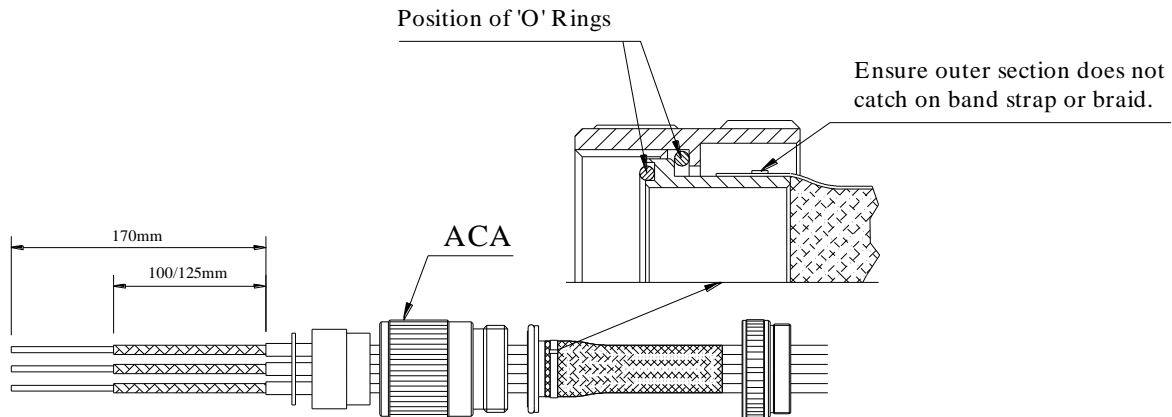

Figure 22. O'ring and Braided Sock Position

- 4.4.9 Strip cable outer insulation exposing the screen for a length of 70mm, and trim off all of this exposed screen.
- 4.4.10 Strip the cable outer insulation to a length of 170mm from the end of the cable, as shown above which then gives a braid length of 100/125mm.

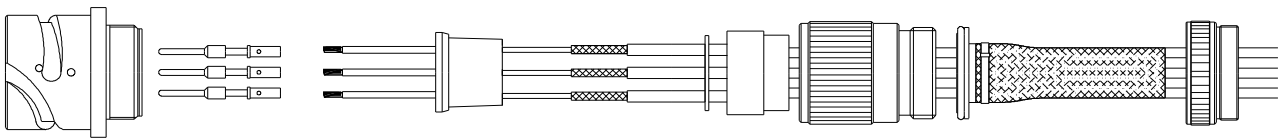

Figure 23. Installation of Contacts

- 4.4.11 Pass individual wires through the grommet before the stripping and crimping operations, as shown.
Important: Pass the individual wires through the grommet in the same orientation, as they will be installed into the insert after crimping of contacts.
- 4.4.12 Strip ends of wires as per chart on page 8.
- 4.4.13 Crimp the contacts on to the wires following the instructions on page 9.
- 4.4.14 Hold the receptacle flange firmly or if a vice is used, cushion the vice jaws to prevent damage to the connector finish.
- 4.4.15 Insert the contacts following the instructions 1.7.5 through to 1.8.6 on pages 5 & 6.
- 4.4.16 Tighten Conduit Adaptor to Connector as shown below;

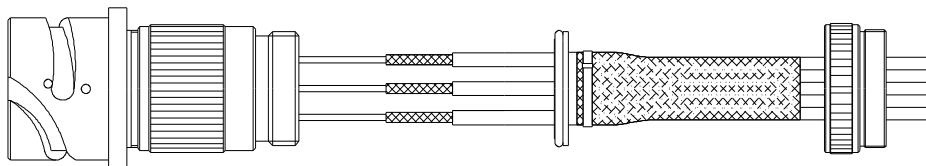

Figure 24. Installed Adaptor

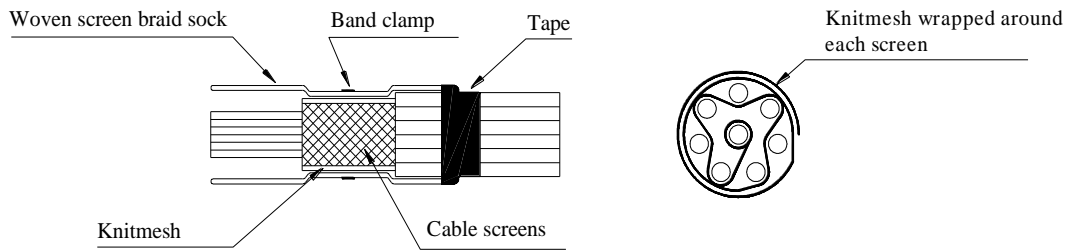

Figure 25. Interweaving Knitmesh

- 4.4.17 Interweave the knit mesh braid either between each individual cable screen or around each multi-core outer screen, and finally around the outside of the wire bundle or multi-cores (see sectioned view).
- 4.4.18 Secure the knit mesh braid with an appropriate tinned copper wire.
- 4.4.19 Slide outer component of RFI adaptor over inner component / braid sock assembly and screw on to the connector conduit adaptor rear threads.

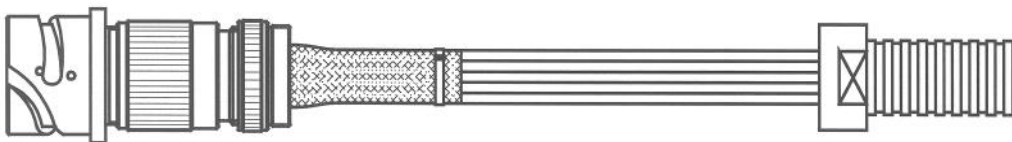

Figure 26. Finalised Screen Termination

- 4.4.20 Terminate braid sock and knit mesh braid using a clamp band. Apply appropriate tape to protect ends of braid sock. (See sectioned view). Alternatively fold sock back on itself as in "A" to provide clean edge.



Figure 27. Completed Assembly

- 4.4.21 Pull the conduit system forward over braid sock termination and secure to rear threads of RFI / conduit Adaptor.
- 4.4.22 This assembly caters for any rework situation at the connector, without disturbing the knit mesh / clamp band termination.

4.5 Method: D: RFI Grounding.

4.5.1 The following method allows RFI grounding of wire bundles through 90°. It uses two stainless steel clamp bands that concentrically close to mechanically grip and electrically terminate the overall shield to: -

- The connector backshell (RFI / conduit adaptor).
- The wire bundles or multi-core cables.

4.5.2 Also the special arrangement of connector Backshells i.e. 90° angled outlet & RFI / conduit adaptor provide an interface to a conduit system.

4.5.3 Procedure is as Method C except that the connector conduit adaptor is replaced with a 90° angled outlet.

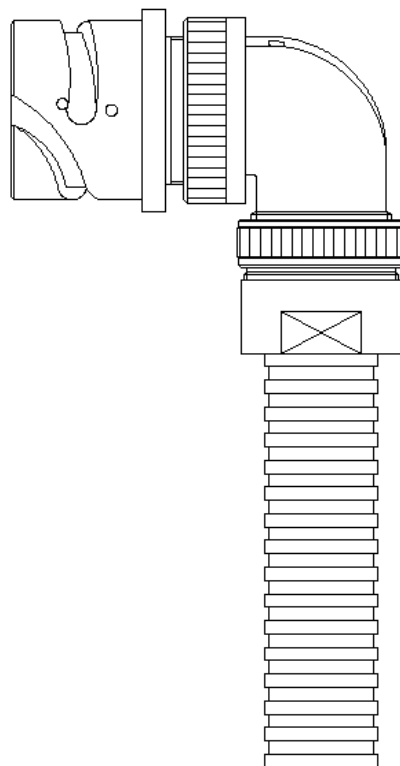

Figure 28. Example of Finished Assembly (90 Degree Elbow)

4.6 Method: E: RFI Grounding of Multi-Core Cable.

4.6.1 The following method allows RFI grounding of multi-core cable with overall screen, through a specially designed backshell with screw on backnut to capture the braid thereby mechanically and electrically terminating it to the backshell. Because there is no sealing provision for jacketed cable with this design, for environmental protection, a knurl on the backnut and a rib on the backshell provide retention for a heat shrink boot, if required.

4.6.2 Procedure Shown on Receptacle connector: -

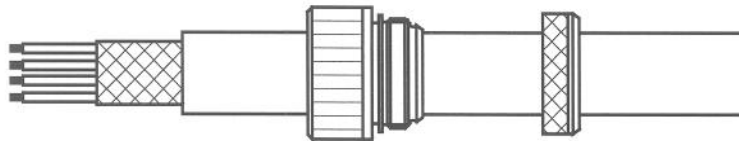

Figure 29. RFI Grounding Multi-Core

4.6.3 Slide the adaptor items over the cable in the correct order. Cut away outer cable jacket to the required length (see table on page 22).

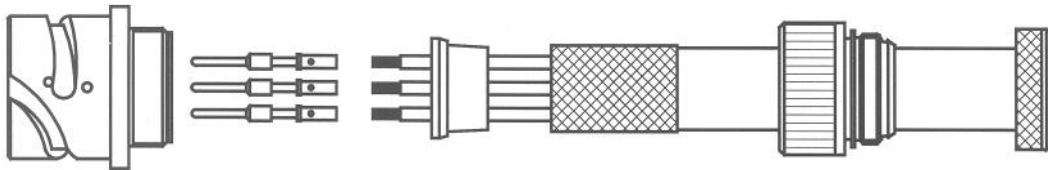

Figure 30. RFI Grounding Exploded Assembly

4.6.4 Pull back the cable screen and pass the individual wires through the grommet before stripping and crimping operations, as shown.

Important: Pass the individual wires through the grommet in the same orientation, as they will be installed into the insert after crimping the contacts.

4.6.5 Strip the end of the wires as per chart on page 8.

4.6.6 Crimp the contacts on the wires following the instructions on page 9.

4.6.7 Hold the receptacle flange firmly or if a vice is used, cushion the vice jaws to prevent damage to the connector finish.

4.6.8 Insert the contacts following instructions 1.7.5 through to 1.8.6 on pages 5 & 6.

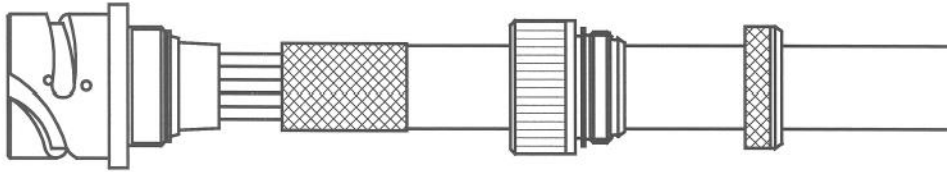

Figure 31. Adaptor Assembly

- 4.6.9 Slide adaptor body forward over the grommet and screw the adaptor on to the receptacle connector accessory thread.
- 4.6.10 Pull forward the screen over the wire groove in rear of the adaptor; Screen must not cover adaptor threads. Wrap a pre-cut length of steel wire completely around portion of screen that is over the wire groove. Using pliers' twist ends of wire together until screen is secured within the groove. Trim off excess wire and screen.

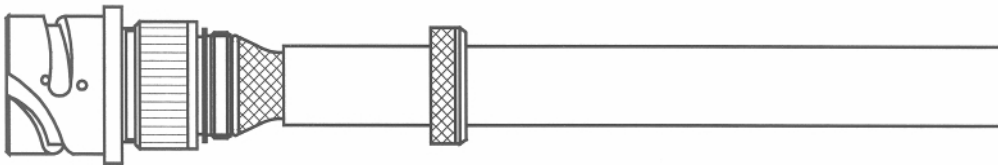

Figure 32. Nut Assembly

- 4.6.11 Slide forwards the backnut and screw onto the adaptor accessory thread. Thus trapping the screen.

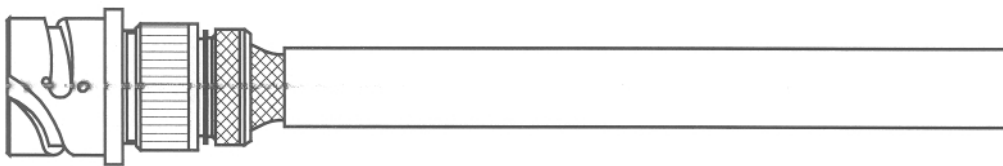

Figure 33. Installed Nut

- 4.6.12 If required a heat shrink boot can be used to finish the assembly. If so it should be placed over the cable, along with the adaptor, at the start of the procedure.

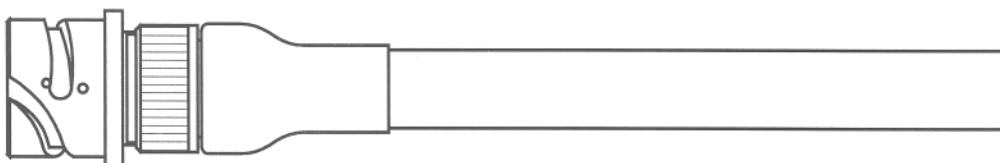

Figure 34. Complete Assembly

4.7 Method: F: Electrical Termination with Clamping Backshell

4.7.1 The following method uses a specifically designed backshell and one stainless steel clamp band that concentrically closes to mechanically grip and electrically terminate the overall shield to: -

4.7.2 The connector backshell (Screened Cable Adaptor)

4.7.3 The wire bundles or multi-core cables.

4.7.4 Procedure shown on Receptacle Connector: -

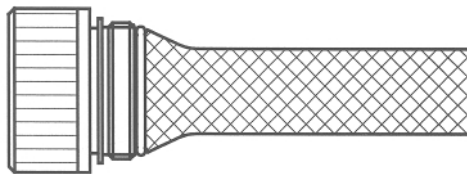

Figure 35. Installation of Braid Sock

4.7.5 Cut the braid sock to length and slide over the tapered portion of the adaptor. Secure with wire.

4.7.6 Slide forwards the backnut and screw onto the adaptor accessory thread. Thus trapping the screen.

4.7.7 Cut away outer cable jacket and screen to dimension Y below.

4.7.8 Procedure is then the same as Method A: Para 2.1.8 through to 2.1.17.

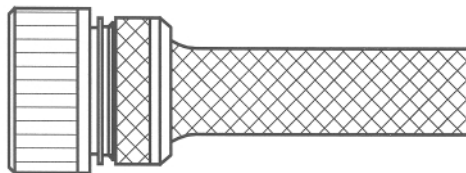

Figure 36. Complete Assembly

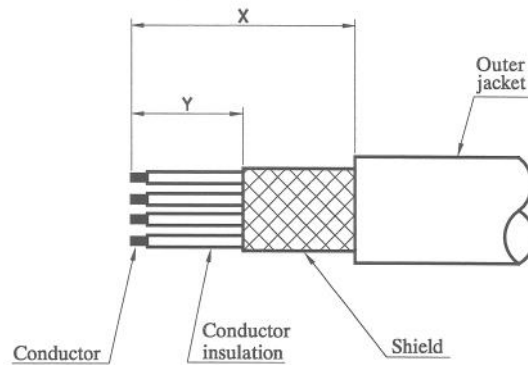

Figure 37. Length Of Screen

Shell Size	X	Y
10SI	75	14
14S	75	14
16S	75	14
16	75	23
18	75	23
20	75	23
22	75	23
24	75	23
28	75	23
32	75	23
36	75	23
40	75	23

Table 2. Screen Lengths

Note: The values are to be used as a guideline only.



APPENDIX A. Crimp and Tooling Data

Crimp and Tooling Data. F80 Contact Style.

Contact Size & Type	Contact Part Number	Wire Size CSA <u>sq.</u> mm	Tool Required	Tool Setting	Tool Required	Tool Setting	Turret/ Locator	Tool Position If Applicable	Insertion Tool	Extraction Tool	Guide Pins
16S/20 Pin	CIRB-16S/20-KPK-F80	0.50/0.75	AF8	3	WA27F	4	TP1249	N/A	CIRB-IT-16	CIRB-ET-16	
16S/20 Skt	CIRB-16S/20-KSK-F80	0.50/0.75	AF8	3	WA27F	4	TP1249	N/A	CIRB-IT-16	CIRB-ET-16	CIRB-16-SGP
16S/18 Pin	CIRB-16S/18-KPK-F80	0.75/0.93	AF8	4	WA27F	5	TP1249	N/A	CIRB-IT-16	CIRB-ET-16	
16S/18 Skt	CIRB-16S/18-KSK-F80	0.75/0.93	AF8	4	WA27F	5	TP1249	N/A	CIRB-IT-16	CIRB-ET-16	CIRB-16-SGP
16S/14 Pin	CIRB-16S/14-KPK-F80	1.94/2.08	AF8	5	WA27F	6	TP1249	N/A	CIRB-IT-16	CIRB-ET-16	CIRB-16-SGP
16S/14 Skt	CIRB-16S/14-KSK-F80	1.94/2.08	AF8	5	WA27F	6	TP1249	N/A	CIRB-IT-16	CIRB-ET-16	CIRB-16-SGP
16S Pin	CIRB-16S-KPK-F80	0.93/1.50	AF8	5	WA27F	6	TP1249	N/A	CIRB-IT-16	CIRB-ET-16	
16S Skt	CIRB-16S-KSK-F80	0.93/1.50	AF8	5	WA27F	6	TP1249	N/A	CIRB-IT-16	CIRB-ET-16	CIRB-16-SGP
16/22 Pin	CIRB-16/22-KPK-F80	0.22/0.34	AF8	2/3	WA27F	3/4	TH592	Blue	CIRB-IT-16	CIRB-ET-16	
16/22 Skt	CIRB-16/22-KSK-F80	0.22/0.34	AF8	2/3	WA27F	3/4	TH592	Red	CIRB-IT-16	CIRB-ET-16	CIRB-16-SGP
16/20 Pin	CIRB-16/20-KPK-F80	0.50/0.75	AF8	3	WA27F	4	TH592	Blue	CIRB-IT-16	CIRB-ET-16	
16/20 Skt	CIRB-16/20-KSK-F80	0.50/0.75	AF8	3	WA27F	4	TH592	Red	CIRB-IT-16	CIRB-ET-16	CIRB-16-SGP
L.I.F. 16/20 Skt	CIRB-16/20-KLK-F80-P3	0.50/0.75	AF8	3	WA27F	4	TH592	Red	CIRB-IT-16	CIRB-ET-16	CIRB-16-SGP
16/18 Pin	CIRB-16/18-KPK-F80	0.75/0.93	AF8	4	WA27F	5	TH592	Blue	CIRB-IT-16	CIRB-ET-16	
16/18 Skt	CIRB-16/18-KSK-F80	0.75/0.93	AF8	4	WA27F	5	TH592	Red	CIRB-IT-16	CIRB-ET-16	CIRB-16-SGP



Application Specification

5375 (08/13)
114-157000

CLASS 1-Public

Contact Size & Type	Contact Part Number	Wire Size CSA sq. mm	Tool Required	Tool Setting	Tool Required	Tool Setting	Turret/Locator	Tool Position If Applicable	Insertion Tool	Extraction Tool	Guide Pins
16 Pin	CIRB-16-KPK-F80	0.93/1.50	AF8	5	WA27F	6	TH592	Blue	CIRB-IT-16	CIRB-ET-16	
16 Skt	CIRB-16-KSK-F80	0.93/1.50	AF8	5	WA27F	6	TH592	Red	CIRB-IT-16	CIRB-ET-16	CIRB-16-SGP
L.I.F. 16 Skt	CIRB-16-KLK-F80-P3	0.93/1.50	AF8	5	WA27F	6	TH592	Red	CIRB-IT-16	CIRB-ET-16	CIRB-16-SGP
16/14 Pin	CIRB-16/14-KPK-F80	1.94/2.08	AF8	5	WA27F	6	TH592	Blue	CIRB-IT-16	CIRB-ET-16	CIRB-16-SGP
16/14 Skt	CIRB-16/14-KSK-F80	1.94/2.08	AF8	5	WA27F	6	TH592	Red	CIRB-IT-16	CIRB-ET-16	CIRB-16-SGP
16/12 Pin	CIRB-16/12-KPK-F80	2.50/3.00	AF8	7	WA27F	8	TH592	Blue	CIRB-IT-16	CIRB-ET-16	CIRB-16-SGP
16/12 Skt	CIRB-16/12-KSK-F80	2.50/3.00	AF8	7	WA27F	8	TH592	Red	CIRB-IT-16	CIRB-ET-16	CIRB-16-SGP
12/20 Pin	CIRB-12/20-KPK-F80	0.50/0.75	AF8	3	WA27F	4	TH592	Yellow	CIRB-IT-12	CIRB-ET-12	
12/20 Skt	CIRB-12/20-KSK-F80	0.50/0.75	AF8	3	WA27F	4	TH592	Yellow	CIRB-IT-12	CIRB-ET-12	CIRB-12-SGP
L.I.F. 12/20 Skt	CIRBB-12/20-KLK-F80-P3	0.50/0.75	AF8	3	WA27F	4	TH592	Yellow	CIRB-IT-12	CIRB-ET-12	CIRB-12-SGP
12/18 Pin	CIRB-12/18-KPK-F80	0.75/0.93	AF8	4	WA27F	5	TH592	Yellow	CIRB-IT-12	CIRB-ET-12	
12/18 Skt	CIRB-12/18-KSK-F80	0.75/0.93	AF8	4	WA27F	5	TH592	Yellow	CIRB-IT-12	CIRB-ET-12	CIRB-12-SGP
12/16 Pin	CIRB-12/16-KPK-F80	0.93/1.50	AF8	5	WA27F	6	TH592	Yellow	CIRB-IT-12	CIRB-ET-12	
12/16 Skt	CIRB-12/16-KSK-F80	0.93/1.50	AF8	5	WA27F	6	TH592	Yellow	CIRB-IT-12	CIRB-ET-12	CIRB-12-SGP
L.I.F. 12/16 Skt	BB-12/16-KLK-F80-P3	0.93/1.50	AF8	5	WA27F	6	TH592	Yellow	CIRB-IT-12	CIRB-ET-12	CIRB-12-SGP
12/14 Pin	CIRB-12/14-KPK-F80	1.94/2.08	AF8	5	WA27F	6	TH592	Yellow	CIRB-IT-12	CIRB-ET-12	
12/14 Skt	CIRB-12/14-KSK-F80	1.94/2.08	AF8	5	WA27F	6	TH592	Yellow	CIRB-IT-12	CIRB-ET-12	CIRB-12-SGP



Application Specification

5375 (08/13)
114-157000

CLASS 1-Public

Contact Size & Type	Contact Part Number	Wire Size CSA sq. mm	Tool Required	Tool Setting	Tool Required	Tool Setting	Turret/ Locator	Tool Position If Applicable	Insertion Tool	Extraction Tool	Guide Pins
12 Pin	CIRB-12-KPK-F80	2.50/3.00	AF8	7	WA27F	8	TH592	Yellow	CIRB-PT-12	CIRB-ET-12	
12 Skt	CIRB-12-KSK-F80	2.50/3.00	AF8	7	WA27F	8	TH592	Yellow	CIRB-IT-12	CIRB-ET-12	CIRB-12-SGP
L.I.F. 12 Skt	CIRB-12-KLK-F80-P3	2.50/3.00	AF8	7	WA27F	8	TH592	Yellow	CIRB-IT-12	CIRB-ET-12	CIRB-12-SGP

Crimp & Tooling Data, F80 Contact Part 1



Application Specification

5375 (08/13)
114-157000

CLASS 1-Public

Crimp and Tooling Data. F80 Contact Style Continued

Contact Size & Type	Contact Part Number	Wire Size CSA sq. mm	Tool Required	Turret/Locator	Tool Setting	Tool Position If Applicable	Insertion Tool	Extraction Tool	Guide Pins
12/40 Pin	CIRB-12/40-KPK-F80	4	M310	TH592	5	Yellow	CIRB-IT-12	CIRB-ET-12	
12/40 Skt	CIRB-12/40-KSK-F80	4	M310	TH592	5	Yellow	CIRB-IT-12	CIRB-ET-12	CIRB-12-SGP
12/10 Pin	CIRB-12/10-KPK-F80	5.53	M310	TH592	5	Yellow	CIRB-IT-12	CIRB-ET-12	
12/10 Skt	CIRB-12/10-KSK-F80	5.53	M310	TH592	5	Yellow	CIRB-IT-12	CIRB-ET-12	CIRB-12-SGP
8/40 Pin	CIRB-8/40-KPK-F80	4	D55E	Die set MRP 1042	N/A	N/A	N/A	N/A	N/A
8/40 Skt	CIRB-8/40-KSK-F80	4	D55E	Die set MRP 1042	N/A	N/A	N/A	N/A	N/A
8/10 Pin	CIRB-8/10-KPK-F80	5.53	D55E	Die set MRP 1042	N/A	N/A	N/A	N/A	N/A
8/10 Skt	CIRB-8/10-KSK-F80	5.53	D55E	Die set MRP 1042	N/A	N/A	N/A	N/A	N/A
100/60 Pin	CIRB-100/60-KPK-F80	6	D55E	Die set MRP 1038	N/A	N/A	N/A	N/A	N/A
100/60 Skt	CIRB-100/60-KSK-F80	6	D55E	Die set MRP 1038	N/A	N/A	N/A	N/A	N/A
100 Pin	CIRB-100-KPK-F80	10	D55E	Die set MRP 0925	N/A	N/A	N/A	N/A	N/A
100 Skt	CIRB-100-KSK-F80	10	D55E	Die set MRP 0925	N/A	N/A	N/A	N/A	N/A
8 Pin	CIRB-8-KPK-F80	9	D36E	02541	N/A	N/A	N/A	N/A	N/A
8 Skt	CIRB-8-KSK-F80	9	D36E	02541	N/A	N/A	N/A	N/A	N/A
160 Pin	CIRB-160-KPK-F80	16	D55E	Die set MRP 0924	N/A	N/A	N/A	N/A	N/A
160 Skt	CIRB-160-KSK-F80	16	D55E	Die set MRP 0924	N/A	N/A	N/A	N/A	N/A
4Pin	CIRB-4-KPK-F80	22	D36E	02542	N/A	N/A	N/A	N/A	N/A



Application Specification

5375 (08/13)
114-157000

CLASS 1-Public

Contact Size & Type	Contact Part Number	Wire Size CSA sq. mm	Tool Required	Turret/Locator	Tool Setting	Tool Position If Applicable	Insertion Tool	Extraction Tool	Guide Pins
4 Skt	CIRB-4-KSK-F80	22	D36E	02542	N/A	N/A	N/A	N/A	N/A
500/160 Pin	CIRB-500/160-KPK-F80	16	D55E	Die set MRP 0924	N/A	N/A	N/A	N/A	N/A
500/160 Skt	CIRB-500/160-KSK-F80	16	D55E	Die set MRP 0924	N/A	N/A	N/A	N/A	N/A
500/250 Pin	CIRB-500/250-KPK-F80	25	D55E	Die set MRP 1041	N/A	N/A	N/A	N/A	N/A
500/250 Skt	CIRB-500/250-KSK-F80	25	D55E	Die set MRP 1041	N/A	N/A	N/A	N/A	N/A
500/350 Pin	CIRB-500/350-KPK-F80	35	D55E	Die set MRP 1038	N/A	N/A	N/A	N/A	N/A
500/350 Skt	CIRB-500/350-KSK-F80	35	D55E	Die set MRP 1038	N/A	N/A	N/A	N/A	N/A
500 Pin	CIRB-500-KPK-F80	50	D55E	Die set MRP 0925	N/A	N/A	N/A	N/A	N/A
500 Skt	CIRB-500-KSK-F80	50	D55E	Die set MRP 0925	N/A	N/A	N/A	N/A	N/A
0 Pin	CIRB-0-KPK-F80	53	D36E	02614	N/A	N/A	N/A	N/A	N/A
0 Skt	CIRB-0-KSK-F80	53	D36E	02614	N/A	N/A	N/A	N/A	N/A

Crimp & Tooling Data, F80 Contact Part 1



Application Specification

5375 (08/13)
114-157000

CLASS 1-Public

Crimp and Tooling Data. VG95234 Contact Style.

Contact Size & Type	Contact Part Number	Wire Size CSA sq. nun	Tool Required	Turret/ Locator	Tool Setting	Tool Position If Applicable	Insertion Tool	Extraction Tool	Guide Pins
20 Pin	CIRB-20-KPK	0.75/1.0	AF8/WA27F	600325	3	N/A	CIRB-IT-20	CIRB-ET-20	
20 Skt	CIRB-20-KSK	0.75/1.0	AF8/WA27F	600325	3	N/A	CIRB-IT-20	CIRB-ET-20	CIRB-20-SGP
16S Pin	CIRB-16S-KPK	1.0/1.5	AF8/WA27F	600325	5	N/A	CIRB-IT-16	CIRB-ET-16	
16S Skt	CIRB-16S-KSK	1.0/1.5	AF8/WA27F	600325	5	N/A	CIRB-IT-16	CIRB-ET-16	CIRB-16-SGP
16 Pin	CIRB-16-KPK	1.0/1.5	AF8/WA27F	600325	5	N/A	CIRB-IT-16	CIRB-ET-16	
16 Skt	CIRB-16-KSK	1.0/1.5	AF8/WA27F	600325	5	N/A	CIRB-IT-16	CIRB-ET-16	CIRB-16-SGP
12/16 Pin	CIRB-12/16-KPK	1.0/1.5	AF8/WA27F	600325	5	N/A	CIRB-IT-12	CIRB-ET-12	
12/16 Skt	CIRB-12/16-KSK	1.0/1.5	AF8/WA27F	600325	5	N/A	CIRB-IT-12	CIRB-ET-12	CIRB-12-SGP
12 Pin	CIRB-12-KPK	2.5	AF8/WA27F	600325	7	N/A	CIRB-IT-12	CIRB-ET-12	
12 Skt	CIRB-12-KSK	2.5	AF8/WA27F	600325	7	N/A	CIRB-IT-12	CIRB-ET-12	CIRB-12-SGP
60 Pin	CIRB-100/60-KPK	6	D36E	02541	N/A	N/A	N/A	N/A	N/A
60 Skt	CIRB-100/60-KSK	6	D36E	02541	N/A	N/A	N/A	N/A	N/A
8 Pin	CIRB-8-KPK	9	D36E	02541	N/A	N/A	N/A	N/A	N/A
8 Skt	CIRB-8-KSK	9	D36E	02541	N/A	N/A	N/A	N/A	N/A
100 Pin	CIRB-100-KPK	10	D36E	02541	N/A	N/A	N/A	N/A	N/A
100 Skt	CIRB-100-KSK	10	D36E	02541	N/A	N/A	N/A	N/A	N/A



Application Specification

5375 (08/13)
114-157000

CLASS 1-Public

Contact Size & Type	Contact Part Number	Wire Size CSA sq. mm	Tool Required	Turret/ Locator	Tool Setting	Tool Position If Applicable	Insertion Tool	Extraction Tool	Guide Pins
160 Pin	CIRB-160-KPK	16	D36E	02542	N/A	N/A	N/A	N/A	N/A
160 Skt	CIRB-160-KSK	16	D36E	02542	N/A	N/A	N/A	N/A	N/A
4 Pin	CIRB-4-KPK	22	D36E	02542	N/A	N/A	N/A	N/A	N/A
4 Skt	CIRB-4-KSK	22	D36E	02542	N/A	N/A	N/A	N/A	N/A
500 Pin	CIRB-500-KPK	50	D36E	02614	N/A	N/A	N/A	N/A	N/A
500 Skt	CIRB-500-KSK	50	D36E	02614	N/A	N/A	N/A	N/A	N/A
0 Pin	CIRB-0-KPK	53	D36E	02614	N/A	N/A	N/A	N/A	N/A
0 Skt	CIRB-0-KSK	53	D36E	02614	N/A	N/A	N/A	N/A	N/A
0000 Pin	CIRB-0000-KPK	120	C130	V95	N/A	N/A	N/A	N/A	N/A
0000 Skt	CIRB-0000-KSK	120	C130	V95	N/A	N/A	N/A	N/A	N/A

Crimp & Tooling Data, VG95324Contact.

APPENDIX B. Position of Contacts

Fixed Shell

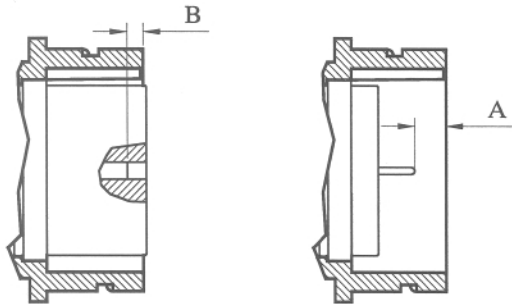

Free Shell

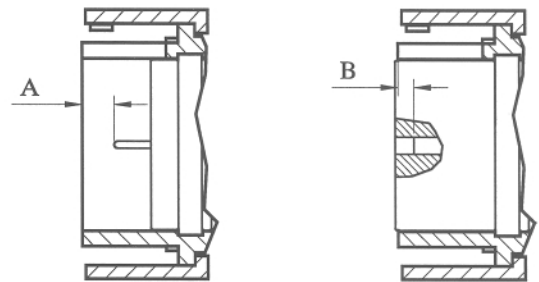

Dimensional Position of Contacts in Fixed & Free Shell Arrangements.

Note: All Dimensions in Millimetres (mm)

Shell Size	Pin 'A' Contact Size				Skt 'B' Contact Size		
	20	16/16s	12	100, 600, 500	20	16S	16, 12, 100, 160, 500
	± 1.0	± 1.0	± 1.0	± 1.0	± 1.0	± 1.0	± 1.0
10 SL, 14S, 16/16S	-	2.2	-	-	-	-	-
18	9.8	6.6	3	2.3	1.4	-	2.6
20	9.8	6.6	3	2.3	1.4	-	2.6
22	9.8	6.6	3	2.3	1.4	-	2.6
24, 28, 32	9.8	6.6	3	2.3	1.4	-	2.6
36, 40	9.8	6.6	3	2.3	1.4	-	2.6

Table Position of Contacts

APPENDIX C. Steel Band Termination Assembly Process

Hand Banding Tool - TE Part No. - CIRB600058

Prepare the band in the following manner: **IMPORTANT:** Due to the connector/adaptor circumference, it may be necessary to prepare the band around the cable retention area.

Roll band through the buckle slot twice.

Pull on band until mark (>|) is within approximately 6.4mm of the buckle slot the band may be tightened further if desired.

Note: prepared band should have mark (>|) visible where approximately shown.

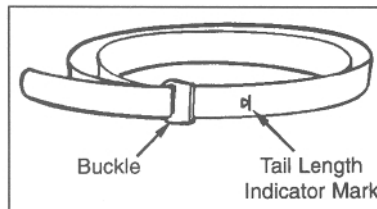

Hand Banding Tool Step 1

Squeeze gripper release lever and insert band into the front end of the opening of the tool.

Important: The straight leg of looped band is to be installed with the circular portion of looped band facing downward towards the black handle

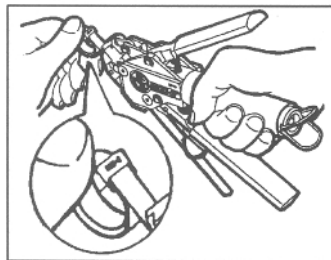

Hand Banding Tool Step 2

Aligning the band and the tool with the shield termination area, squeeze black, pull-up handle repeatedly until it locks against the tool body. (This indicates the band is compressed to the pre-calibrated tension).

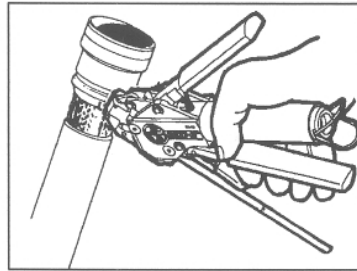

Steel Banding Tool Step 3

Complete the clamping process by squeezing the white cut-off handle.

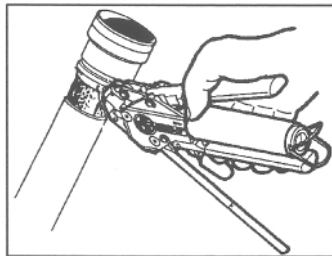

Steel Banding Tool Step 4

Remove excess band from the tool and inspect shield termination.

APPENDIX D. Torque Back Shell Values

Shell Size	Torque Value in/lb	Torque Value Nm
10sl	25	2.83
14s	50	5.65
16s	60	6.78
16	60	6.78
18	70	7.90
20	70	7.90
22	70	7.90
24	70	7.90
28	70	7.90
32	85	9.60
36	100	11.30
40	125	14.13

Table of Backshell Torque Values

Note: Due to the vast number of permutations available for contact arrangements and cable sizes these values are based upon the most densely populated contact arrangements with cables at the maximum limits for the grommet.

Important: The values are to be used as a guideline only.

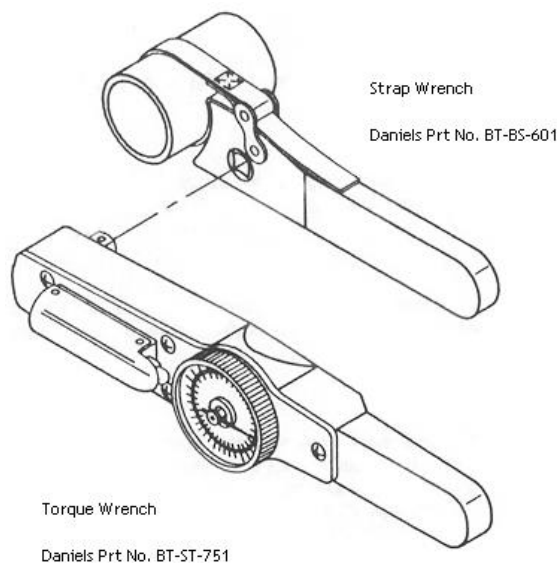

Typical Torque and Strap Wrench

Torque value required to achieve Screen Continuity and Sealing on RFI Backshell (Methods C & D)

TE Connector Part No CIRB**CRA

Shell Size	Torque Value in/lb	Torque Value Nm
10sl	-	-
14s	-	-
16s	-	-
16	25	2.83
18	30	3.39
20	40	4.52
22	40	4.52
24	45	5.10
28	45	5.10
32	60	6.78
36	65	7.35
40	75	8.48

Table of RFI Backshell Torque Values

Note: Due to the vast number of permutations available for contact arrangements and cable sizes these values are based upon the most densely populated contact arrangements with cables at the maximum limits for the grommet.

Important: The values are to be used as a guideline only.

APPENDIX E. Trouble Shooting

These are typical problems that may occur if the procedure is not adhered to.

Symptom	Common Cause	Solutions
Contact heights in connector are not level.	There is an amount of movement that is acceptable for contact position (see sheet 9). Otherwise attempting to push the contacts into the insulator without lubrication is the most likely cause.	Use the recommended lubricant when inserting the contacts. If the contact is moved up and down, after insertion, it should be obvious by "feel" that the contact is seated correctly.
Contacts are twisted out towards connector shell.	Over tightening Backshells or excessive friction between grommet and follower, caused by thick wall insulation cables.	Tighten Backshells to specified torque values. Use lubrication between grommet and follower. Use correct size cables for grommet.
Connector uncouples during use.	Connectors not fully coupled.	Fully align coloured dots on connector surface, an audible "snap" should be heard.
Poor crimp performance, e.g. low pull out forces.	Incorrect crimp tool setting or conductors cut during striping process.	Use the correct calibrated tools and settings (Appendix A). Adjust depth on striping tools so that the conductors are not cut, only insulation.
Contacts short to shell or another contact.	<ol style="list-style-type: none"> 1. Foreign bodies between insert and grommet. 2. Water ingress. 3. Conductive lubricant used to insert contacts. 	<ol style="list-style-type: none"> 1. Check for pieces of swarf or conductor strands on connector faces. 2. Tighten connector to specified torque values. 3. Do not use conductive sleeve lubricants
Water ingress to backshell.	<ol style="list-style-type: none"> 1. No grommet. 2. Incorrect cable for grommet. 3. Slack Backshells. 4. Contacts pushed through grommet after crimping 	<ol style="list-style-type: none"> 1. Check for grommet. 2. Build up insulation thickness to fit grommet using heat-shrink. 3. Tighten Backshells to specified torque value. 4. Insert cables through grommet before crimping.
"Band-it" strap will not hold screen.	Strap only wrapped around once before tightening.	Wrap strap twice around backshell before tightening.
Poor screen continuity.	<ol style="list-style-type: none"> 1. Incorrect use of "band-it" strap. 2. Slack Backshells. 	<ol style="list-style-type: none"> 1. As above. 2. Tighten Backshells to specified torque value.
Contacts push back when connector is mated.	Use of a sleeve lubricant when inserting contacts.	Use the recommended lubricant (solvent) when inserting the contacts as this evaporates after use; also some sleeve lubricants are conductive.
Connectors will not couple.	Attempting to couple wrong orientation connector.	Ensure connector is correct orientation before mating. Connector alignment dots are coloured to indicate orientation.
Cannot tighten Backshells to free connectors.	Free connector difficult to grip due to coupling nut spinning.	Mate free connector with receptacle before tightening backshell.

Trouble Shooting