



NOTE

All numerical values are in metric units [with U.S. customary units in brackets]. Dimensions are in millimeters [and inches]. Unless otherwise specified, dimensions have a tolerance of ± 0.25 [± 0.64] and angles have a tolerance of $\pm 2^\circ$. Figures and illustrations are for identification only and are not drawn to scale.

1. INTRODUCTION

This specification covers the requirements for application of TE Connectivity (TE) HDP series connector system. HDP20 features quick connect-disconnect bayonet coupling, single hole bulkhead mounting, silicone seals, and a rear insertion/rear removal contact system.

The HDP20 Series is a heavy duty rated, environmentally sealed, composite shell, multi-pin connector. The composite thermoplastic shell is ideal in applications where chemicals can damage a connector housing. HDP20 features quick connect-disconnect bayonet coupling, single hole bulkhead mounting, silicone seals, and a rear insertion/rear removal contact system.

Basic terms and features of this product are provide in Figure 1 and 2 for standard and reverse configuration, respectively. HDP Series are available in size 18 and 24. See Figure 3 for pin arrangements.

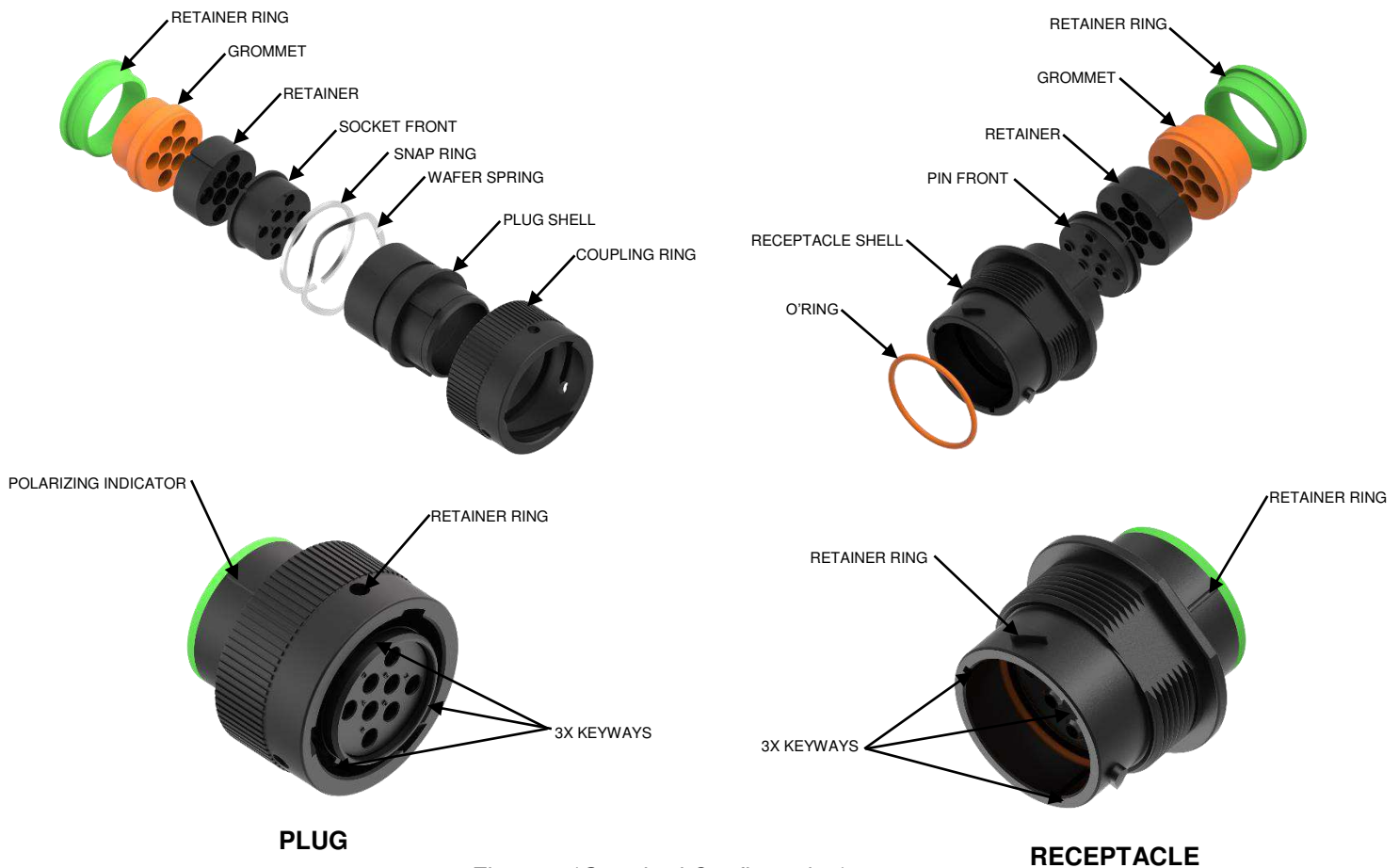

Figure 1 (Standard Configuration)



Note

The polarizing indicator is same color as shell. The color is shown only to highlight the feature.

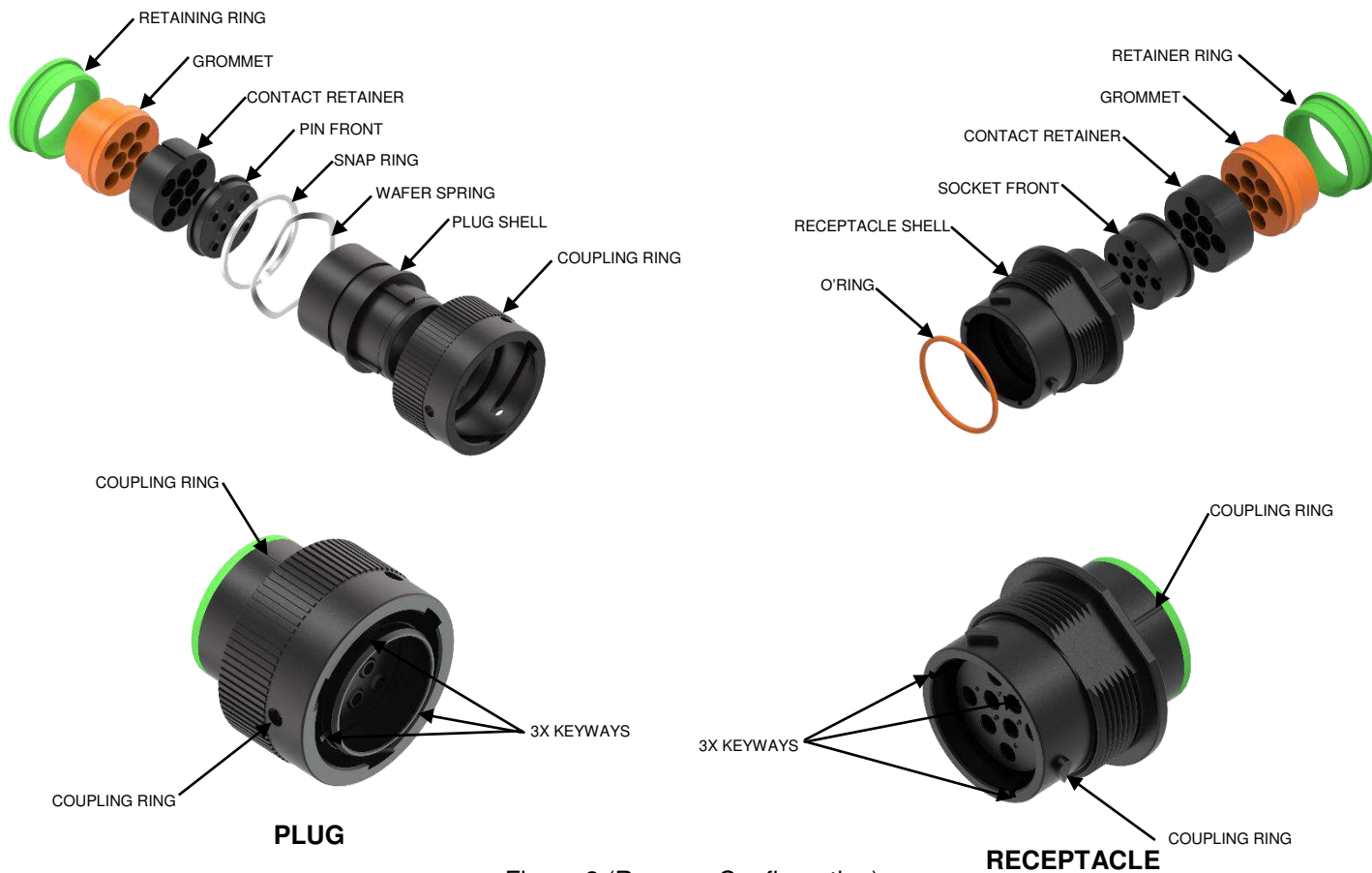

Figure 2 (Reverse Configuration)

Note

The polarizing indicator is same color as shell. The color is shown only to highlight the feature.

1.1 Product Dimensions

Plug



Receptacle



Shell Size	Overall Length A	Overall Height ØB	Overall Length C	Overall Height ØD
18	1.521 [38.63]	1.700 [43.17]	1.648 [41.86]	1.750 [44.45]
24	1.521 [38.63]	1.950 [49.53]	1.648 [41.86]	2.000 [50.80]

2. REFERENCE MATERIAL

2.1 Revision Summary

See section 8

2.2 Customer Assistance

Reference Product Base Part Numbers, HDP24-18-XXP/SX-XXXX, HDP24-24-XXP/SX-XXXX, HDP26-18-XXP/SX-XXXX, HDP26-24-XXP/SX-XXXX. Where XX is pin arrangement, X is seal type (N,T,E), XXXX is modification code. Product Code EQ91 is representative of DEUTSCH HDP series connector system. Use these number will identify the product line and help you obtain product and tooling information when visiting www.te.com or calling the number at the bottom of page 1.

2.3 Drawings

Customer drawings for product part numbers are available from www.te.com. Information contained in the customer drawing takes priority.

Product Drawing	Description
HDP24-18-XXP/SX	Size 18 Receptacle
HDP24-24-XXP/SX	Size 24 Receptacle
HDP24-18-14PE-C041	Size 18 Receptacle
HDP24-18-6P/SX-C030	Size 18 Receptacle
HDP24-18-6PX	Size 18 Receptacle
HDP24-18-XP/SX-L017	Size 18 Receptacle
HDP24-18-XXP/SX-L015	Size 18 Receptacle
HDP24-18-XXP/SX-L024	Size 18 Receptacle
HDP24-24-7PN-C038	Size 24 Receptacle
HDP24-24-7PN-CL18	Size 24 Receptacle
HDP24-24-7PN-CL19	Size 24 Receptacle
HDP24-24-7PN-CL22	Size 24 Receptacle
HDP24-24-91PX-P064	Size 24 Receptacle
HDP24-24-XXP/SX-L015	Size 24 Receptacle
HDP24-24-XXP/SX-L017	Size 24 Receptacle
HDP24-24-XXP/SX-L024	Size 24 Receptacle

Product Drawing	Description
HDP26-18-XXP/SX	Size 18 Plug
HDP26-18-14SE-CL20	Size 18 Plug
HDP26-18-6P/SX-C030	Size 18 Plug
HDP26-18-6SN-CL16	Size 18 Plug
HDP26-18-6SN-CL21	Size 18 Plug
HDP26-18-6SX	Size 18 Plug
HDP26-18-XP/SX-L017	Size 18 Plug
HDP26-18-XXP/SX-L015	Size 18 Plug
HDP26-18-XXP/SX-L024	Size 18 Plug
HDP26-24-XXP/SX	Size 24 Plug
HDP26-24-7SN-C038	Size 24 Plug
HDP26-24-7SN-C018	Size 24 Plug
HDP26-24-7SN-C019	Size 24 Plug
HDP26-24-7SN-C022	Size 24 Plug
HDP26-24-91SE-L024	Size 24 Plug
HDP26-24-91SX-L015	Size 24 Plug
HDP26-24-91SX-P064	Size 24 Plug
HDP26-24-91SX-PL04	Size 24 Plug
HDP26-24-XXP/SX-L015	Size 24 Plug
HDP26-24-XXP/SX-L017	Size 24 Plug
HDP26-24-XXP/SX-L024	Size 24 Plug

2.4 Specifications

108-151015	DEUTSCH HDP Series Product Specification
108-151000	DEUTSCH S&F Contact Product Specification
108-151004	DEUTSCH Solid Contact Product Specification
114-151000	DEUTSCH Size 16 S&F Pin and Socket Application Specification
114-151001	DEUTSCH Size 16 S&F Pin and Socket Application Specification
114-151002	DEUTSCH Size 12 S&F Pin and Socket Application Specification
114-151003	DEUTSCH Size 20 S&F Pin and Socket Application Specification
114-151004	DEUTSCH Size 4-20 Solid Pin and Socket Application Specification
114-151006	DEUTSCH Size 12 S&F Pin and Socket Application Specification
0425-013-1800	Size 18 Arrangements
0425-014-2400	Size 24 Arrangements

2.5 Instructional Material

Instruction sheets (408-series) provide product assembly instructions or tooling setup, and operation procedures and customer manuals (409-series) provide machine setup and operating procedures. Instructional material that pertain to this product are:

408-151007	DEUTSCH Extraction Tools for Rear-Release Connectors
408-151066	DEUTSCH Sealing Plugs and Locking Keying Pins
408-151078	DEUTSCH Extended PCB Pins
408-151083	DEUTSCH Size 4 Crimp Sleeve Reducer

3. REQUIREMENTS

3.1. Safety

Do not stack product shipping containers so high that the containers buckle or deform.

3.2. Storage

A. Ultraviolet Light

Prolonged exposure to ultraviolet light may deteriorate the chemical composition used in the product material.

A. Shelf Life

The product should remain in the shipping containers until ready for use to prevent deformation to components. The product should be used on a first in, first out basis to avoid storage deterioration could adversely affect performance.

B. Chemical Exposure

Do not store product near any chemical listed below as they may cause stress corrosion cracking in the material.

Alkalis	Amines	Carbonates	Nitrites	Sulfur Nitrites	Tartrates
Acids	Ammonia	Citrates	Phosphates	Sulfur Compounds	



NOTE

Resistance depend on chemical concentration, temperature, and exposure medium.

3.3 Characteristics

A. Part Numbering system

HDP 26 – 24 – 21 S X - XXXX

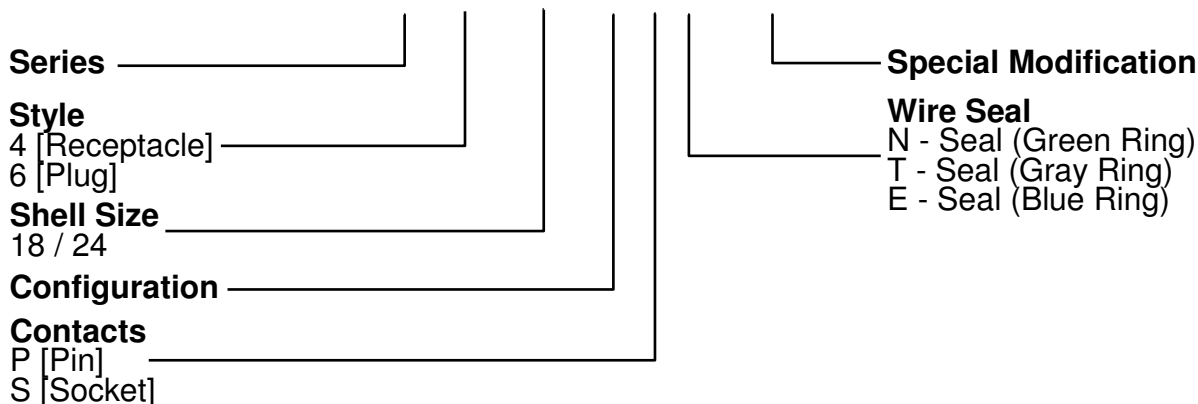

B. Pin Arrangements

Size 18 (See 0425-013-1800 for contact cavity marking)

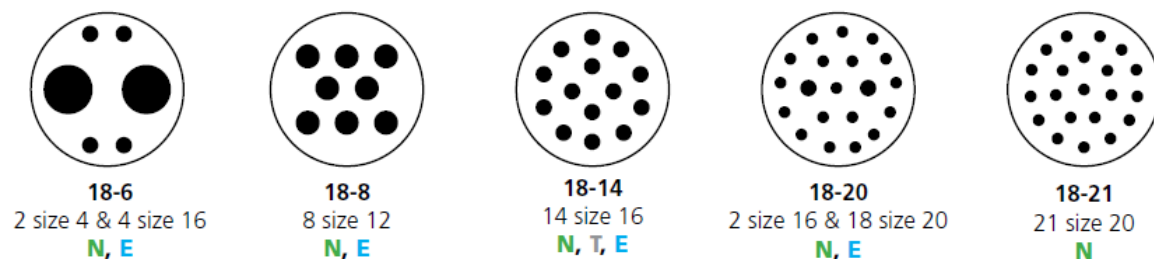

Size 24 (See 0425-014-2400 for contact cavity marking)

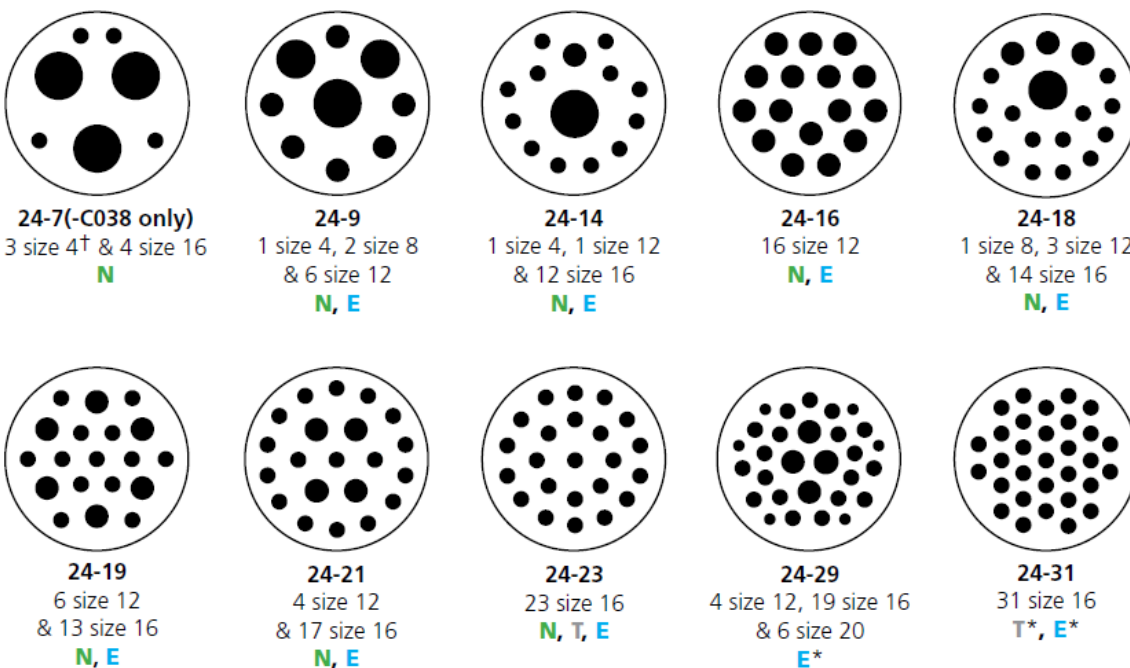

†Requires size 4 contact part number, 5960-203-04**(Pin) and 5962-203-04**(Socket).

*Modified seal see drawing.

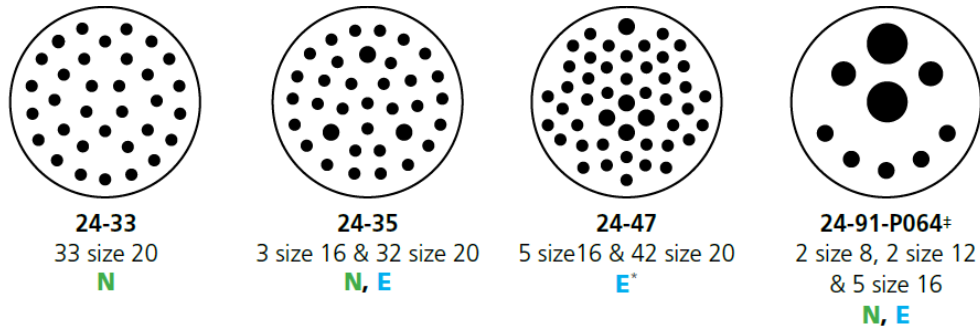

‡Without P064 modification, plug cavities 4 and 5 are internally connected.

Figure 3 Pin Arrangements

C. Materials

Retainer Ring: PA66 10GF (Green, Gray, Blue)
 Grommet: VMQ (Burnt-Orange)
 Contact Retainer: PEI (Black)
 Snap Ring: Steel
 Socket Front: PEI (Black)
 Pin Front: TPE (Black)
 Plug Shell: PA66 10GF (Black)
 Receptacle Shell: PA66 10GF (Black)ss
 Wafer Spring: Steel
 Coupling Ring: PA66 10GF (Black)

D. Sealing Range

Contact Size	N-Seal Green Ring	T-Seal Gray Ring	T-Seal Modified*	E-Seal Blue Ring	E-Seal Modified*
20 14-22 AWG [2.5-0.35mm ²]	.040-.095 [1.02-2.41]	.040-.095 [1.02-2.41]	-	.040-.095 [1.02-2.41]	.040-.083 [1.01-2.10]
16 14-20 AWG [2.0-0.5mm ²]	.100-.134 [2.54-3.40]	.088-.134 [2.23-3.40]	.088-.106 [2.24-2.69]	.053-.120 [1.35-3.05]	.053-.103 [1.35-2.62]
12 10-14 AWG [6.0-2.0mm ²]	.134-.170 [3.40-4.32]	.113-.170 [2.87-4.32]	-	.097-.158 [2.46-4.01]	.097-.158 [2.46-4.01]
8 8-10 AWG [10.0-5.0mm ²]	.190-.240 [4.83-6.10]	.170-.240 [4.32-6.10]	-	.135-.220 [3.43-5.59]	-
4 6 AWG [16.0-13.0mm ²]	.280-.292 [7.11-7.42]	.261-.292 [6.63-7.42]	-	.261-.292 [6.63-7.42]	-
4 4 AWG [25.0-21.0mm ²]	.311-.420 [7.90-10.67]	-	-	-	-

*Arrangements 24-29, 24-47 and 24-31 are only available with modified seals.
 Arrangement 24-31 modified E-Seal= 0.053 – 0.106 [1.35 – 2.69]

Green: N-Seal
Gray: T-Seal
Blue: E-Seal

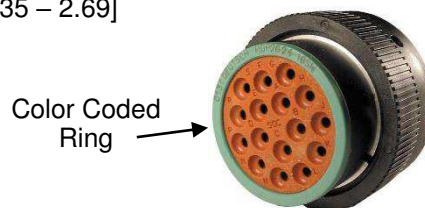

E. Sealing Plugs

Open cavities provide pathways for contaminants to enter the connectors. To maintain seal integrity, any unused cavity must be filled with the appropriate size sealing plug. See [408-151066](#) for instructions.

Part Number	Contact Size	Material	Color	Description	Sealing Plug
114019	4	VMQ	Red-Orange		
114018	8	PBT	White		
114017	12, 16	PBT	White		
0413-217-1605	16	PBT	White	Locking	
0413-003-1605	16	PBT	Blue		
0413-204-2005	20	PBT	Red		

F. Keying Pins

Keying pins are solid plastic rods used to help prevent mis-mating of like connectors in close proximity. Keying pins are inserted into the retention fingers of an empty socket cavity. Once installed, the keying pin blocks a mating contact pin from being inserted. The contact pin will be blocked before the coupling device mates the connectors, helping to prevent the mis-mating of like connectors. Proper usage requires that the corresponding mating pin be omitted, and a sealing plug inserted in the rear cavity of the mating connector. Individual applications will vary, and testing should be done to determine the best pattern arrangement to help prevent improper connector mating. See [408-151066](#) for instructions.

Part Number	Contact Size	Material	Color	Description	Sealing Plug
0413-216-2005	20	PBT	Red	Keying	
0413-215-1605	16	PBT	White		
0413-214-1205	12	PBT	Yellow		



Note:
Multiple keying pins may be required to help prevent unintentional forced mating.

G. Modifications

Mod	Description
C018	Cavities blocked (11, 18, 19), N/E seal options
C019	Cavities blocked (1, 2, 8, 9), N/E seal options
C022	Cavities Blocked (A, D, J, M), with reduced diameter seals (E seal)
C030	4 size 16 cavities blocked (1, 2, 5, 6)
C038	3 size 4, 4 size 16, special size 4 AWG contacts
C041	Receptacle with diagnostic keying
CL16	Four size 16 cavities blocked (1, 2, 5, 6) and ring adapter for back
CL18	3 size 4, 4 size 16, special size 4 AWG contacts and ring adapter for backshell
CL19	3 size 4, 4 size 16, special size 4 AWG contacts and threaded adapter for backshell
CL20	Plug with diagnostic keying
CL21	4 size 16 cavities blocked (1, 2, 5, 6) and threaded adapter for backshell
CL22	3 size 4, 4 size 16, special size 4 AWG contacts and wide threaded adapter for backshell
L015	Threaded adapter for backshell
L017	Ring adapter for backshell
L024	Wide threaded adapter for backshell
P064	24-91 arrangement without internal jumper
PL04	24-91 arrangement without internal jumper and ring adapter for backshell

The L015, L017, L024 adapter modifications provide simple, low cost assembly solutions for applications that require a backshell or conduit. The adapters are designed to be used with the backshell of your choice.



L015
Threaded Adapter



L017
Ring Adapter



L024
Wide Threaded
Adapter

C030 Modification

Size 18, 2 pin connector that accept size 4 solid contacts rated up to 100 amps for each cavity.



C041 / CL20 Modifications

C041: size 18, 14 pin connector with a data link key and E-seal grommet on the receptacle.

CL20: size 18, 14 pin connector with a data link key, L017 ring adapter and E-seal grommet on the plug.



H. Mounting Hardware

DEUTSCH lockwashers and panel nuts are available to aid in mounting the HDP20 Series connectors. The lockwashers are used to add tension between the threads and the nut to provide a secure mount. The lockwasher and the panel nut should be used together.

LOCKWASHER



Shell Size	Part Number	OD
18	2414-002-1886	1.892 [48.06]
24	2414-001-2486	2.080 [52.83]

Material: Spring Steel, Tin plate

Operating temperature is -55°C to +125°C [-67° to +257°F].

PANEL NUT

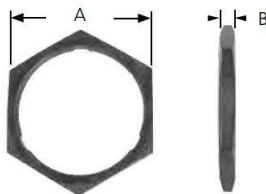

Shell Size	Part Number	A	B
18	2411-002-1805	1.685 [42.80]	.250 [6.35]
24	2411-001-2405	1.875 [47.63]	.250 [6.35]

Material: PEI

Operating temperature is -55°C to +125°C [-67° to +257°F].

Plastic nut is better than metal nut on HDP's

I. Mounting

RECEPTACLE MOUNTING

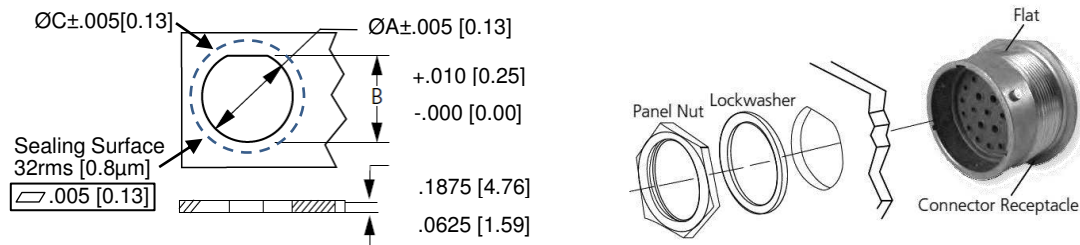

Shell Size	ØA	B	ØC
18	1.507 [38.28]	1.442 [36.63]	1.75 [44.45]
24	1.696 [43.08]	1.632 [41.45]	2.00 [50.80]

D HOLE PUNCH

The D hole punch is a hand tool used to cut a D shaped hole. The D shaped hole allows the connector to be securely mounted and prevents the connector from spinning.



Punchable Material:
Up to .078" mild steel or aluminum. Up to .1875" plastic, wood, paneling, or other soft material.
Tool Material:
A2 material heat treated to a Rockwell hardness of 60 to 62.
Tool Size: (rough dimensions)
5.5"L x 2"H x 2" D
Sharpening:
The tool can be sharpened as needed.
Usability:
A .625" minimum pilot hole is required to accommodate the draw stud. Air tools can be used.

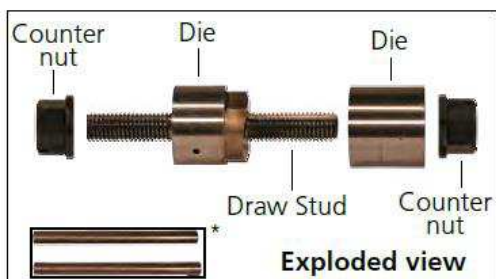

The rods included with the "D" hole punch are used to remove the cutout and are not used in the cutting process.

Shell Size	Part Number
18	18-D-PUNCH
24	24-D-PUNCH

J. Accessories

Several accessory items can be used to complement the connectors such as PVC boots, plastic backshells, neoprene closed cell gaskets, and plastic protective caps. Accessories are designed to complete the application and meet a wide array of design requirements such as solutions for mounting, providing additional protection, and offering increased aesthetics.

BOOTS

Slip-on boots are not only aesthetically appealing, but also provide increased protection from dirt, paint overspray, and pressure washing.



Part Number	Description
HD30-18BT	18 shell size boot, gray
HD30-18BT-BK	18 shell size boot, black
HD30-18BT-90-BK	18 shell size boot, 90° bend, black
LC-90BT-HT	18 shell size boot, 90° bend, high temperature material, yellow
HD30-24BT	24 shell size boot, gray
HD30-24BT-BK	24 shell size boot, black
HD30-24BT-90-BK	24 shell size boot, 90° bend, black
MT-90BT-HT-24	24 shell size boot, 90° bend, high temperature material, yellow

Material: PVC
Operating temperature is -29°C to +100°C [-20° to +212°F].

PROTECTIVE DUST CAPS

Protective caps are available for receptacle. An optional rubber and steel lanyards are available to protect the connector while not mated.



Shell Size	Part Number	Description
18	HDC26-18	Plug cap for receptacle protection, environmentally sealed
24	HDC26-24	

Material: PA66

Operating temperature is -55°C to +125°C [-67° to +257°F].

BACKSHELL AND ADAPTERS FOR L017 MODIFICATION



Shell Size	Orientation	L017 Backshell Part Number	Conduit Size
18	Straight	2428-016-1805	13, 17, 19 (mm) NW
	90°	2428-015-1805	13, 17, 19 (mm) NW
24	Straight	2428-008-2405	1"
	90°	2428-004-2405	1"
24	Straight	2428-010-2405	17, 19, 23, 26 (mm) NW
	90°	2428-011-2405	17, 19, 23, 26 (mm) NW

Material: PA66

Operating temperature is -55°C to +125°C [-67° to +257°F].

THREADED ADAPTER FOR L015 MODIFICATION



Shell Size	Conduit Adapter Part Numbers		Conduit Size
18 and 24	Seal Ring: SRN21	Cap Nut: CN21	22 (mm) NW

Material: Seal Neoprene, Cap Nut PA66

Operating temperature is -40°C to +134°C [-40° to +273°F].

BACKSHELL FOR L015 MODIFICATION

Designed to screw onto connectors with the L015 modification, which adds a threaded adapter. The rigid, durable backshells offer a high level of protection, provide strain relief, and improve aesthetics.



Shell Size	Cable Diameter	Backshell	Compression Nut
18 and 24	.430-.570 [10.92-14.48]	M902-2243	M902-2053
	.570-.710 [14.48-18.03]	M902-2244	M902-2054

Material: PC/PBT

Operating temperature is -40°C to +134°C [-40° to +273°F].

BACKSHELLS FOR L024 MODIFICATION

Designed to screw onto connectors with the L024 modification, which adds a wide threaded adapter. The rigid, durable backshells offer a high level of protection, provide strain relief, and improve aesthetics.



Shell Size	Orientation	L024 Backshell Part Number
18	Straight	2428-025-1805
24		2428-024-2405

Material: PA66

Operating temperature is -55°C to +125°C [-67° to +257°F].

GASKETS

Moisture, dirt, salt, sand, and road debris can all work their way into electrical panels through unsealed mounting flanges. These rugged high quality gaskets form a tight seal between the panel face and connector flange to help keep out destructive elements. The gaskets have a thickness of .125 [3.18]



Shell Size	Part Number
18	16-04978
20	16-04477

Material: Closed Cell Sponge

Operating temperature is -57°C to +107°C [-70° to +225°F].

CRIMP SLEEVE REDUCER

A crimp sleeve reducer allows DEUTSCH size 4 solid contacts to accept 8-10 AWG wire. When populating a connector using a contact with a reducer sleeve, be sure the insert seal penetrates the rear grommet. The use of the crimp sleeve reducer requires no extra crimp tools and provides an easy transition and increased flexibility. Used on pin arrangements with size 4 contact cavity. See [408-151083](#) for instructions.



Part Number	Description	Material	Image
0410-241-0406	Insert Seal	VMQ Red-Orange	
0421-203-04141	Crimp Sleeve Reducer	Copper Alloy Nickel	

EXTENDED PCB PINS

Straight reduced diameter extended pins are available for installation in the DEUTSCH family of connectors. The use of removable contacts provides design flexibility and a low cost alternative to meet application needs. These solid copper alloy pins may be specified in various plating's. See [408-151078](#) for instructions.

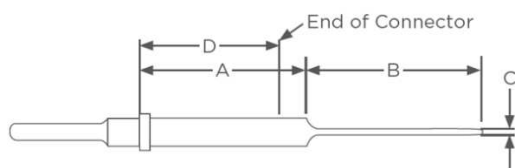

Contact Size	Part Number	A	B	C
20	0460-208-2031	1.305	.248	.025
	0460-208-2090	[33.15]	[6.30]	[.64]
16	0460-208-16141	1.300	.248	.025
	0460-208-1631	[33.02]	[6.30]	[.64]
	0460-241-16141	1.305	.160	.040
	0460-244-16141	.976	.400	.041
	0460-244-1631	[24.79]	[10.16]	[1.04]
12	0460-208-12141	1.305	.248	.025
	0460-245-1231	1.024	.500	.041
	0460-245-1290	[26.01]	[12.70]	[1.04]



3.4 Contact Insertion

- The crimped contacts must meet these specification:
 - [114-151000](#) DEUTSCH Size 16 S&F Pin and Socket Application Specification
 - [114-151001](#) DEUTSCH Size 16 S&F Pin and Socket Application Specification
 - [114-151002](#) DEUTSCH Size 12 S&F Pin and Socket Application Specification
 - [114-151003](#) DEUTSCH Size 20 S&F Pin and Socket Application Specification
 - [114-151004](#) DEUTSCH Size 4-20 Solid Pin and Socket Application Specification
 - [114-151006](#) DEUTSCH Size 12 S&F Pin and Socket Application Specification

- Ensure the correct connector configuration is being used before inserting contacts.
 Standard Configuration: Pins used in receptacle; Sockets used in plug.
 Reverse Configuration: Sockets used in receptacle; Pins used in plug.



- Push contacts straight into the grommet until a positive stop is felt. The contact will lock into place. A slight tug on wire will confirm that it is properly locked in place.

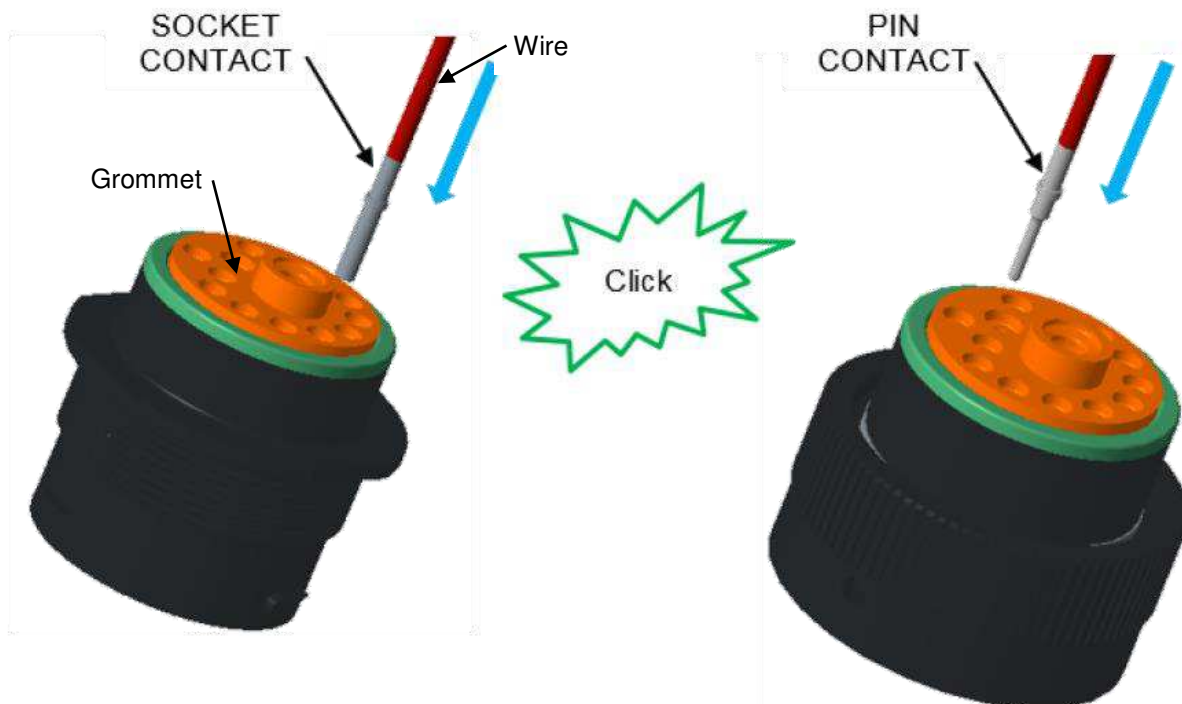

Note

- Wire insulation outside diameter must meet connector wire sealing range per section 3.3.D.
- Insertion tool, [M15570-16](#) (size 16) or [M15570-20](#) (size 20) may be needed for ≤ 20 AWG wire.

3.5 Contact Insertion Tool

Insertion tools are used to help insert small gage wired contacts into connectors that utilize a round shoulder contact retention system. Insertion tools are compact, easy-to-use and made with durable plastic to insert wired contacts without damage to wire, insulation, rear grommet seal or connector housing.

1. USING THE TOOL

1. Insert the wired contact into the colored end wire entry slot and gently pull back until the contact locking shoulder is against tool.
2. Push the tool/wired contact assembly into the connector rear until the contact is felt snap into position within the retainer.
3. While holding the wire forward, gently pull remove tool out.
4. A slight tug on wire will confirm the contact is properly locked in place.

Contact Size	Part Number	Mil-Spec	Color Insertion	Insertion Tool
16	M15570-16	M81969/14-03	Blue	
20	M15570-20	M81969/14-11	Red	

CAUTION
 Do not twist or insert the insertion tool at an angle; otherwise, damage to the cavity retention finger(s) will result.

3.6 Contact Removal

DEUTSCH removal tools are designed to simplify contact removal and field service repair in connectors that utilize a round shoulder contact retention system. Removal tools are compact, easy-to-use, and manufactured of heavy duty plastic to remove contacts without damage to the wire, insulation, connector seals, or connector body.

Each extraction tool is designed to extract individual DEUTSCH solid and stamped and formed (S&F) pin and socket contacts from rear-release connectors. See [408-151007](#) for instructions.

1. USING THE TOOL

1. From the rear of the connector, align the tool tip with the contact cavity of the contact to be removed. Place the wire of the contact over the tool wire entry slot and apply light pressure on the wire until it enters the wire entry slot. See Figure 6, Detail A.
2. Slide the tool along the wire and into the contact cavity until the tool tip engages the contact and resistance is felt. See Figure 6, Detail A.
3. Gently pull the tool with the wire until the contact is removed. See Figure 6, Detail B.



CAUTION
 Do not twist or insert the extraction tool at an angle; otherwise, damage to the cavity retention finger(s) will result.



Part Number	Contact Size	Wire Gauge Range	Color
0411-027-0405	Size 4	4 AWG	Black
114009	Size 4	6 AWG	White
114008	Size 8	8-10 AWG	Green
0411-353-0805	Size 8 for HD Box	8-10 AWG	Green Extended
114010	Size 12	12 AWG	Yellow
0411-337-1205	Size 12	12 AWG Extra Thin Wall (E-Seal)	Orange
0411-291-1405	Size 16	14-16 AWG	Green
0411-310-1605	Size 16	16-20 AWG	Light Blue
0411-336-1605	Size 16	16-20 AWG Extra Thin Wall (E-Seal)	Dark Blue
0411-240-2005	Size 20	20-22 AWG	Red

3.7 Sealing Plug, Locking Sealing Plug and Keying Pin Installation

Sealing Plug Installation ([408-151066](#))

Step 1:

Holding the sealing plug with large diameter end away from the connector, gently apply downward pressure to force the sealing plug into the cavity.

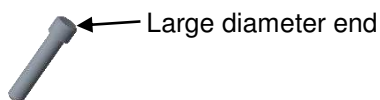

Step 2:

With perpendicular motion, apply downward pressure to the large diameter end of the sealing plug.

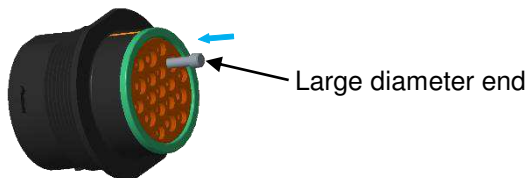

Step 3:

Apply pressure until sealing plug is forced to stop by contact with rear grommet. Visually inspect the sealing plug to confirm it is flush with cavity opening.



Locking Sealing Plug Installation (408-151066)

Step 1:

Holding the sealing plug with locking shoulder end towards the connector, gently apply downward pressure to force the sealing plug into the cavity.

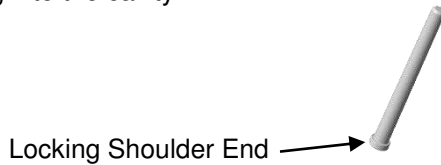

Step 2:

With perpendicular motion, apply downward pressure to the small diameter end of the sealing plug.

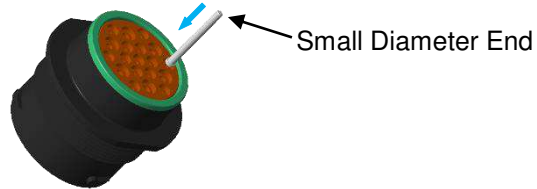

Step 3:

Apply pressure until sealing plug locks into place. A slight tug on the sealing plug will confirm it is locked into place.



Keying Pin Installation (408-151066)

Step 1:

Holding the keying pin with large diameter end towards the connector, gently apply downward pressure to force the sealing plug into the cavity.

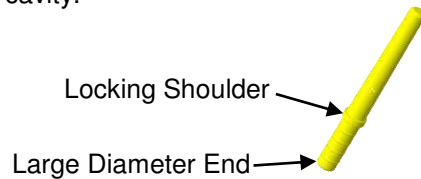

Step 2:

With perpendicular motion, apply downward pressure to the small diameter end of the sealing plug.

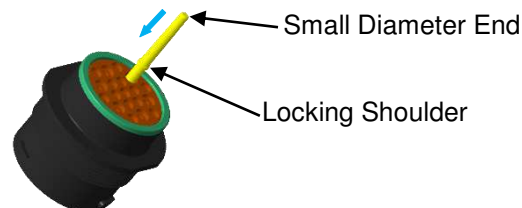

Step 3:

Apply pressure until keying pin locks into place. A slight tug on the sealing plug will confirm it is locked into place.



3.8. Connector Mating

To mate the plug and receptacle, the plug keys and receptacle keyways must align as shown in figure. Once aligned, it is pushed until it reaches the inner base of the connector and the Coupling Ring is screwed until the guides are observed through the holes in the Coupling Ring. Rotate the coupling ring until it comes to a hard stop. This will indicate that the connector is fully mated.

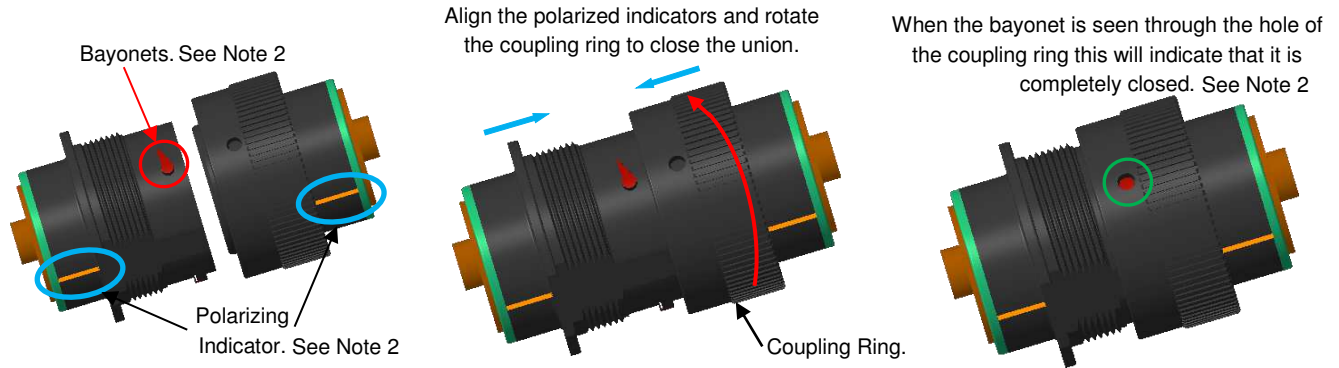

Polarized indicators serve as guides to make the connection between the connectors, each connector has an internal guide that makes the holes of the cavities are aligned but these are not visible to the naked eye, so the polarized indicators help us connect the connectors in better shape.

i Note 1
It is not recommended to use dielectric grease on either plug or receptacle. The HDP connectors are guaranteed to seal and perform per 108-151015 product performance without the application of grease or other foreign substance.

i Note 2
The polarizing indicator and bayonet is same color as shell. The color is shown only to highlight the feature.

3.9. Connector Unmating

1. To uncouple the HDP connector, turn coupling ring counterclockwise. This will unlock the lock and allow them to separate.

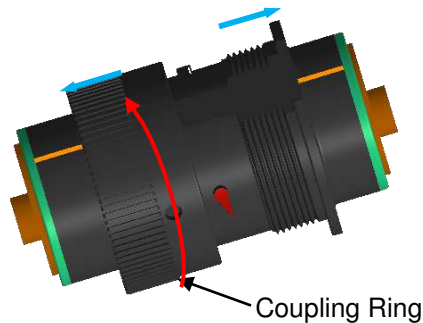

2. To separate the connectors, uncouple the Coupling Ring counterclockwise to unmate, follow the connector as indicated by the arrows.

i Note
The polarizing indicator and bayonet is same color as shell. The color is shown only to highlight the feature.

3.10. Backshell, Adapter, Boot, Gasket, Protective Dust Cap Installation and Removal

See section J for part numbers.

L017 BACKSHELL

1. To install the backshell or adapter, it must first be in the open position as shown. The slots on the backshell will line up and fit onto the flange on the housing. Slide one half of the backshell onto housing as shown. Orientation of the opening is important on the plug housing; backshells may be oriented as desired on receptacles. HDP connector plug is shown as an example. Use the same method to install the backshell on all housings.

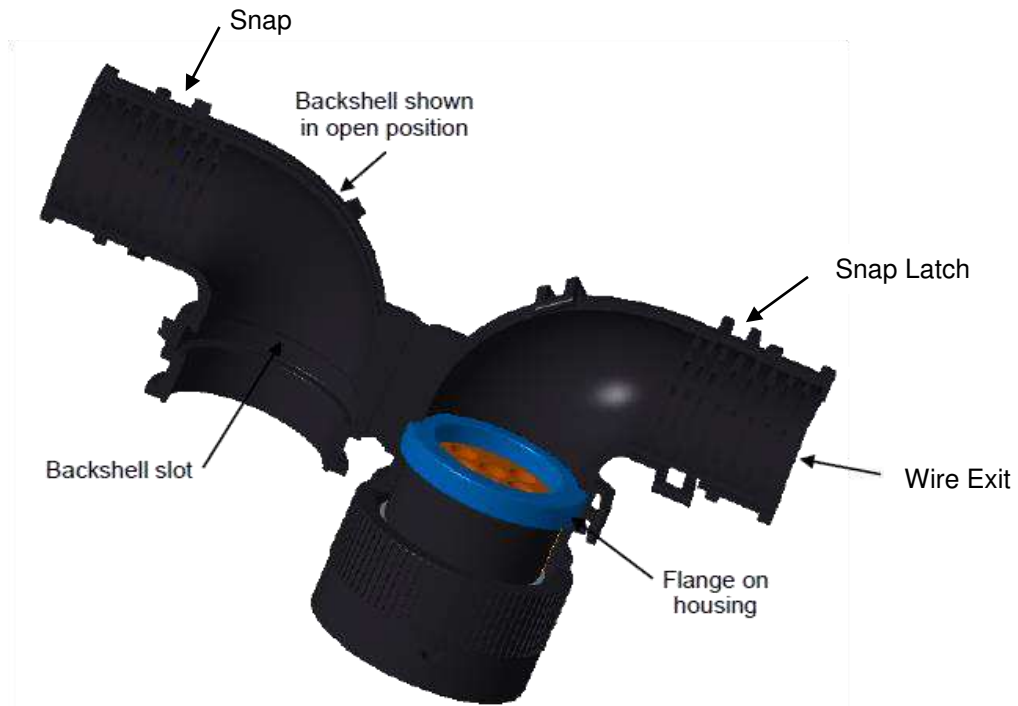

2. To close the backshell, rotate other half and line up the slots in the backshell line up with flange on housing (as described in previous step). Before snapping shut, make sure convoluted tubing (if used) is captured within the inner grooves. If no convoluted tubing is used, make sure any wires are not pinched in the backshell. There are four snaps that need to engage in order to properly snap shut the backshell.



- To remove the backshell, disengage all four snaps by wedging a DT-RT1 tool or small flat head screwdriver under the snap latch, lift until disengaged the pry the backshell open.



L015 BACKSHELL AND ADAPTER

- The first step for the installation of backshell and compression nut starts with the insertion of wires in the connector, once inserted the wires are passed through the backshell.

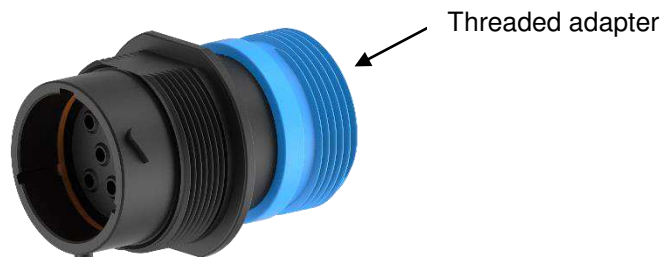

- The second step is to screw the backshell on the back of the connector and hand tight. The connector has a threaded adapter which the backshell is threaded on.



- As a third step the wires will be passed through the compression nut and this will be screwed in the back part of the backshell in this way the wires will be secured. Hand tight compression nut.



Cap Nut and Seal Ring

Cap Nut and Seal Ring is similar to the backshell. Insert the wires in the connector then pass the wires through the Seal Ring and Cap Nut. Screw the Cap Nut onto the threaded adapter, hand tight.

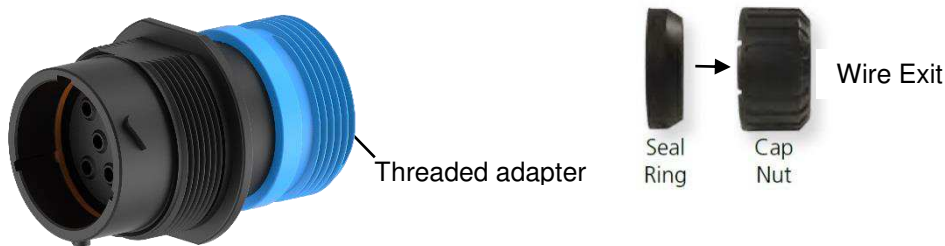

L024 BACKSHELL

First insert the wires into the connector. Next pass through the wires through the backshell then screw the backshell onto the threaded adapter and hand tight. If needed, install tie wrap and cut off excess.



BOOT

First insert the wires into the connector. Next, cut off the end of the boot as needed then pass through the wires through the boot. Slide the boot onto the connector. If needed, attach a tie wrap on the end of the connector and boot. Trim tie wrap as needed.

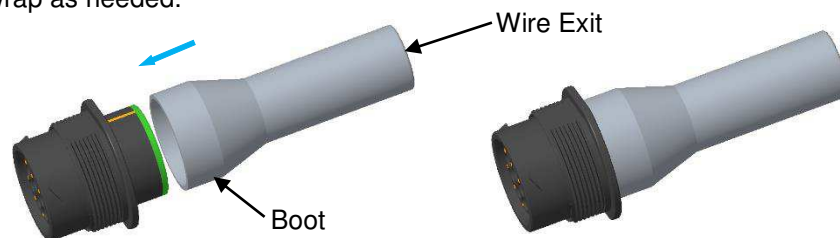

GASKET

Install the gasket onto the connector in front of the flange. Next install into panel mounting hole. See section 3.9 for panel installation.



PROTECTIVE DUST CAP

To mate the protective cap to the receptacle, align the bayonets on the receptacle to the openings on the cap. Turn clockwise until a snap is felt. Remove in reverse steps.



Use a lanyard to keep dust cap safe and close to connector when is not in use.

3.11. Panel Installation

1. The receptacles may be mounted to a panel as shown. A clocking feature on the housing may be used to orient the connector on the panel, but the panel cutout must contain the proper tab in order to properly utilize this feature. If a gasket is used, ensure the gasket is installed onto the housing before inserting mating side through the panel cutout.

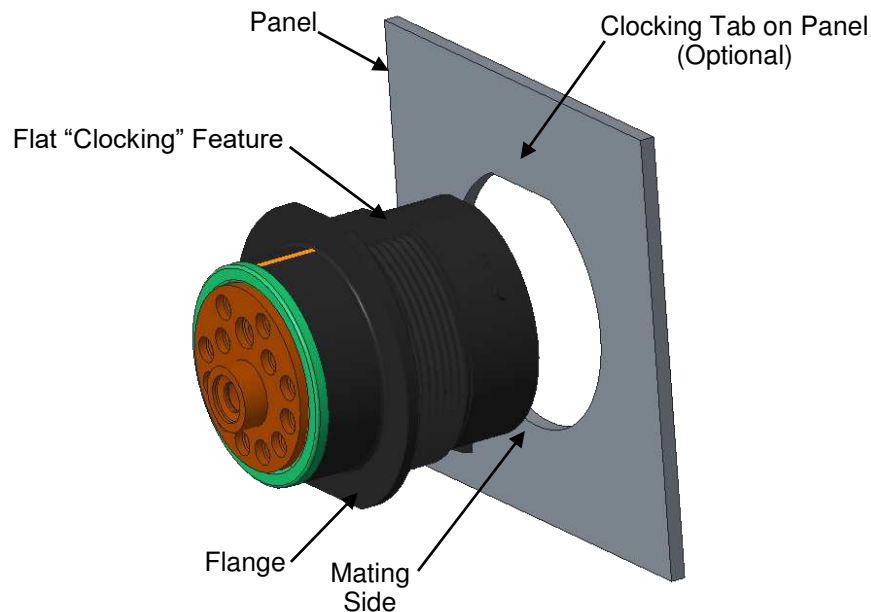

2. Install Lock Washer and Panel Nut. Secure the receptacle to the panel using the recommended mounting torque.

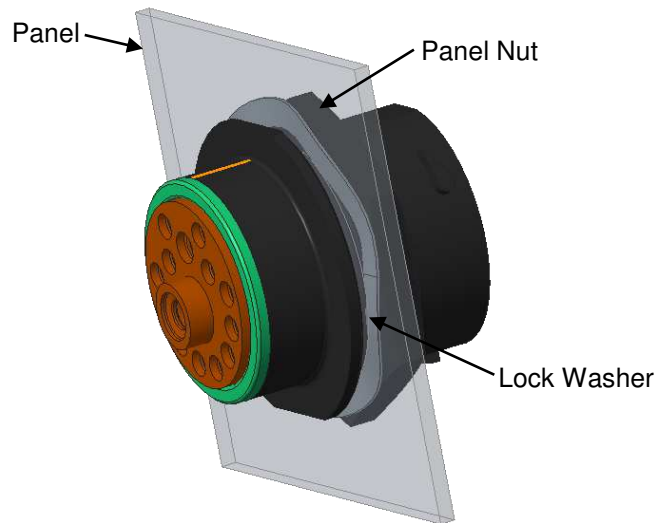

Panel Nut Mounting Torque			
Shell size	Mounting torque	Socket Size	Tool Speed Max
18	45-55 IN. LB. [5.1-6.1 N.M]	1-11/16"	5 RPM
24	65-75 IN. LB. [7.4-8.4 N.M]	1-7/8"	

i Note:
Do not cross thread panel nut or over torque panel nut

3.12. Replacement and Repair

Damaged or defective connectors must not be used. These connectors cannot be repaired.

4. QUALIFICATION

Refer to product specification [108-151015](#) for qualification and approved agency.

5. TOOLING

Refer to the following application specifications for reference on all pins and sockets contact termination tooling

114-151000	DEUTSCH Size 16 S&F Pin and Socket Application Specification
114-151001	DEUTSCH Size 16 S&F Pin and Socket Application Specification
114-151002	DEUTSCH Size 12 S&F Pin and Socket Application Specification
114-151003	DEUTSCH Size 20 S&F Pin and Socket Application Specification
114-151004	DEUTSCH Size 4-20 Solid Pin and Socket Application Specification
114-151006	DEUTSCH Size 12 S&F Pin and Socket Application Specification

6. HELPFUL HINTS

Helpful hint

Proper wire outside diameters help provide water tight seals.

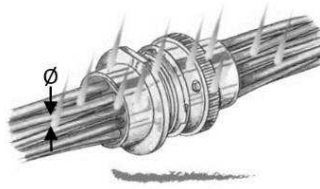

Helpful hint

Proper wire routing assures. Water tight seal performance

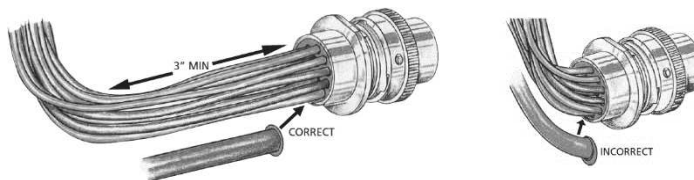

Helpful hint

Making the socket contact side the "hot side" can reduce the danger of electric shock.

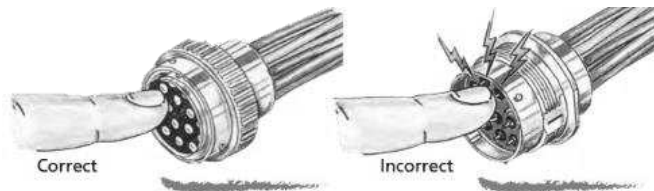

Helpful hint

Pulling lightly on the wire after it is snapped in place will assure the contact is locked.

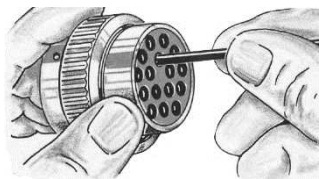

Helpful hint

Sealing plugs are used to seal the connector when all the cavities are not used by wires.

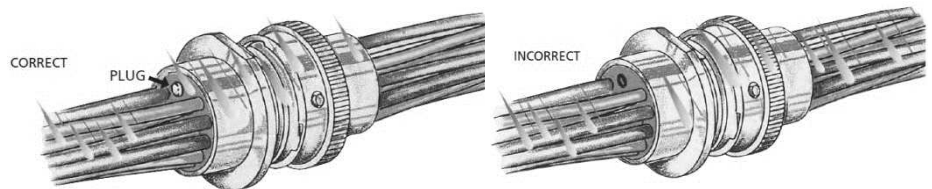

Helpful hint

Mounting connectors horizontally allows proper Water drainage.

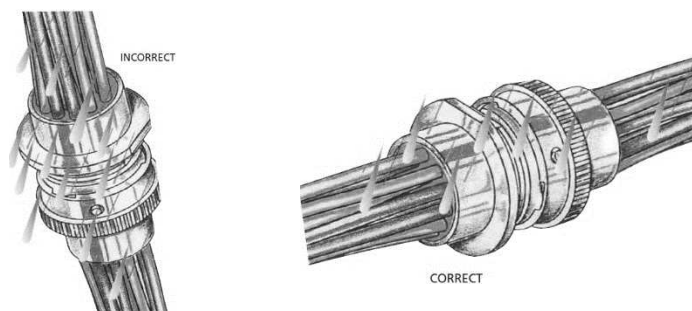

Helpful hint

Planned wire routing and clamp points can reduce harness cost by eliminating strain reliefs.

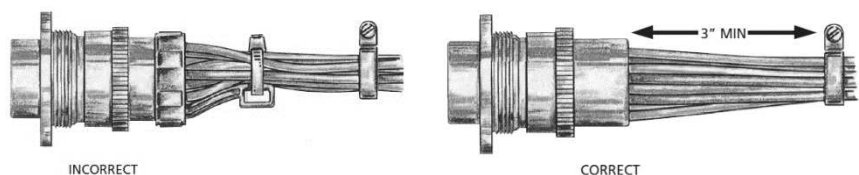

Helpful hint

Attaching the connector to a structure eliminates straining the electrical system in service.

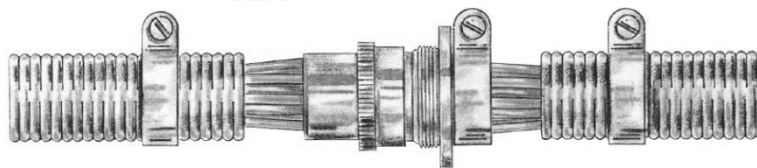
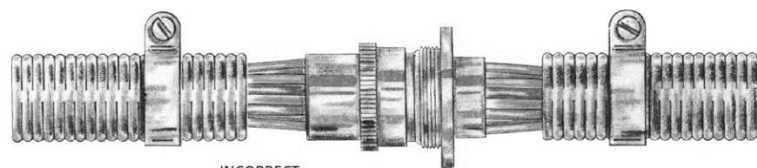

Helpful hint

Tie wraps and tape away from the rear of the connector will allow the wire to be sealed properly.

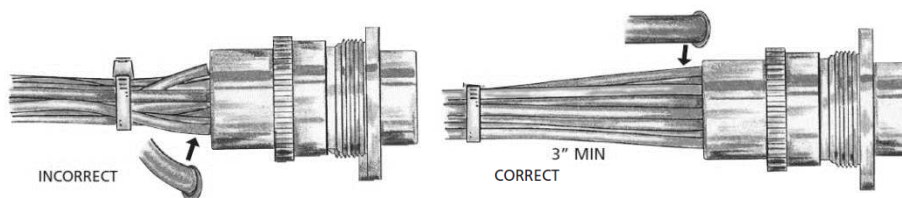

Helpful hint

Harness design should permit filling the connector cavities from the center out in order to provide support for the center of the harness and to allow easier connector assembly.

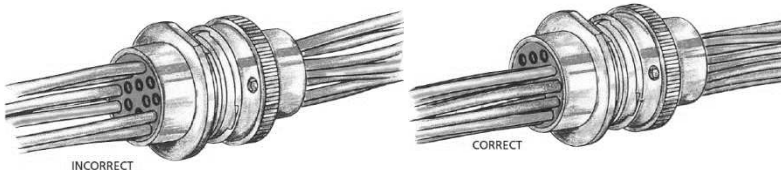

Helpful hint

A contact removal tool taped or tie wrapped to the harness will make it easily available should repairs be needed.

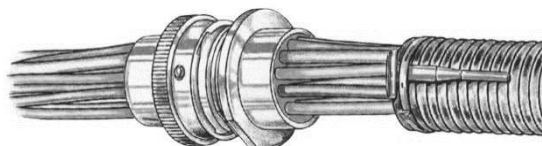

7. VISUAL AID

Below shows a typical application of the HDP Series Connector. This illustration should be used by production personnel to ensure a correctly applied product. Applications which DO NOT appear correct should be inspected using the information in the proceeding pages of this specification and in the instruction material shipped with the product or tooling.

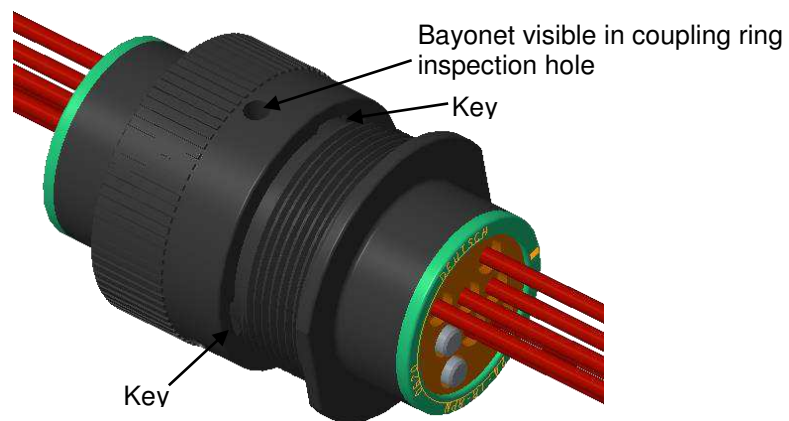
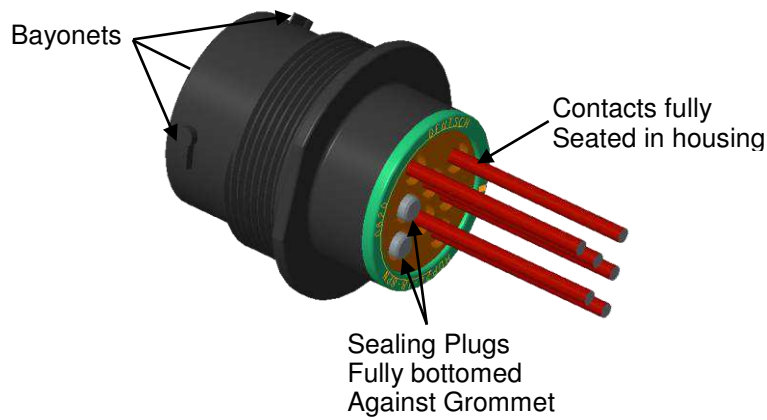

8. REVISION HISTORY

Rev Ltr	Brief Description of Change	Date	Dwn	Apvd
A	Initial Release	14-Mar-18	JA	DM
B	Page 1, 2: Added note "The polarizing indicator is same color as shell..." Page 16, 17: Added Note "The polarizing indicator and bayonet is same color as shell..." and moved mating/unmating blue directional arrows off the connector. Page 20: Under L024 section, moved blue directional arrows off backshell. Page 21: Added note "The polarizing indicator is same color as shell..." Page 14: Added information 3.5 Contact Insertion Tool.	13-Apr-18	JA	DM
B1	Page 22: Added missing "24" to Shell Size.	15-Nov-19	DM	DM
C	General formatting and added hyperlinks throughout document Sec 2.4 Added 108-151000, 108-151004, 114-151004, 114-151006 Sec 2.5 Add 408-151066, 408-151078, 408-151083 Page 6. Added 3D view showing different color rings for seal type Page 8. Clarified C041/CL20 definitions Page 9. Added sealing surface requirement for panel mounting Page 13 Added Crimp Sleeve Reducer section Page 13 Added Extended PCN Pin section Sec 3.4 Add 114-151004, 114-151006. Deleted 0425-205-0000 Page 23 Deleted second note under panel mounting Sec 5 Added 114-151004. Deleted 0425-205-0000	12/16/2019	DM	DM
C1	Page 11 Added size 18 to L015 Threaded Adapters Page 12 Added size 18 to L015 Backshells	08/10/2020	DM	IG
C2	Page 18 Sec 3.8, first paragraph. Added "Rotate the coupling ring until it comes to a hard stop. This will indicate that the connector is fully mated."	08/13/2020	DM	IG
C3	Page 1 Updated tolerance from +/- .005 [+/-0.13] to +/- .025 [+/-0.64]. Updated the images of Pin front from Keyshot renders with material color Black. Page 6 Updated the Grommet material from VMQ (Red-Orange) to VMQ (Burnt Orange) Page 12 Added additional Note for Cable clamp With bushing. Page 22 Protective dust cap images updated with Lanyard and additional clarification point added to it.	04/19/2023	GB	IG