



NOTE

All numerical values are in metric units [with U.S. customary units in brackets]. Dimensions are in millimeters [and inches]. Unless otherwise specified, dimensions have a tolerance of ± 0.13 [± 0.005] and angles have a tolerance of $\pm 2^\circ$. Figures and illustrations are for identification only and are not drawn to scale.

1. INTRODUCTION

This specification covers the requirements for application of DEUTSCH DTP series connector system. The system features a plug and receptacle that offers 2 and 4-pin arrangements which accept DEUTSCH size 12 solid (machined) or stamped & formed contacts.

The plug and receptacle each consist of a housing and secondary wedge lock. The secondary wedge lock is used to ensure that the contact is fully seated and secure in the connector. The connector and the secondary wedge lock are shipped separately. These connectors feature latch-style mating.

Basic terms and features of this product are provided below. Pages 2 through 4 provide examples of additional features and modifications.

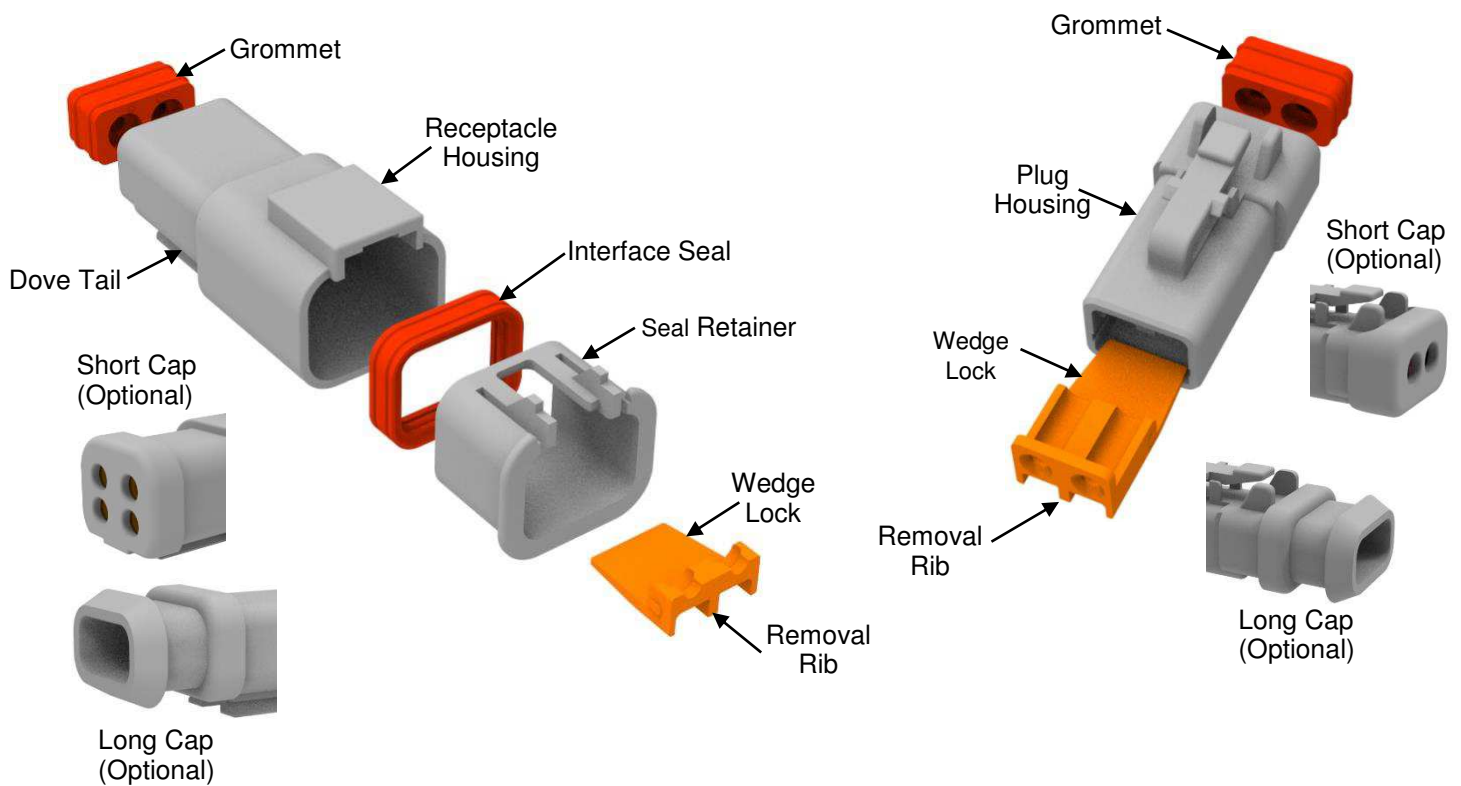

Standard Features All Arrangements
(2-pin example)

1.1. Receptacle

2 and 4-pin



Receptacles, No Cap, Gray and Black

2 and 4-pin



Receptacles, Short Cap, Gray and Black

2-pin



Receptacles, Long Cap, Black

2-pin



Receptacle, Gray, Flange

4-pin



1.2. Plug

2 and 4-pin

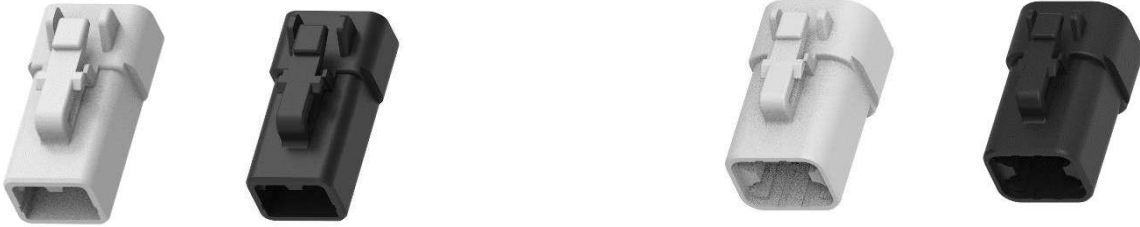

Plugs, No Cap, Gray and Black

2 and 4-pin



Plugs, Short Cap, Gray and Black

2 and 4-pin



Plugs, Long Cap, Black

1.3. Product Dimensions

See connector and wedge product drawing for product dimensions. See section 2.3

2. REFERENCE MATERIAL

2.1. Revision Summary

See section 8.

2.2. Customer Assistance

Reference Product Base Part Numbers DTP04-2P, DTP04-4P and DTP06-2S, DTP06-4S and Product Code EQ69 are representative of DEUTSCH DTP series connector system. Use of these numbers will identify the product line and help you to obtain product and tooling information when visiting www.te.com or calling the number at the bottom of page 1.

2.3. Drawings

Customer drawings for product part numbers are available from www.te.com. Information contained in the customer drawing takes priority. XXXX refers to product modification.

CONNECTORS

Product Drawing	Description	Product Drawing	Description
DTP04-2P-XXXX	2 Pin Receptacle	DTP06-2S-XXXX	2 Pin Plug
DTP04-4P-XXXX	4 Pin Receptacle	DTP06-4S-XXXX	4 Pin Plug

WEDGE

Product Drawing	Description	Product Drawing	Description
WP-2P	2 pin Rcpt Wedge Lock	WP-2S	2 pin Plug Wedge Lock
WP-4P	4 pin Rcpt Wedge Lock	WP-4S	4 pin Plug Wedge Lock

2.4. Specifications

- [108-151000](#) Product Specification for DEUTSCH Stamped and Formed Contacts
- [108-151004](#) Product Specification for DEUTSCH Solid Contacts
- [108-151012](#) Product Specification DTP Series
- [114-151002](#) Application Specification for DEUTSCH Size 12 S&F Pin and Socket Contacts
- [114-151004](#) Application Specification for DEUTSCH size 4-20 Solid Pin & Socket
- [114-151006](#) Application Specification for DEUTSCH Size 12 S&F Pin and Socket Contacts

2.5. Instructional Material

Instruction sheets (408-series) provide product assembly instructions or tooling setup, and operation procedures and customer manuals (409-series) provide machine setup and operating procedures. Instructional material that pertain to this product are:

[408-151008](#) DEUTSCH Removal Tool DT-RT1 for Front-Release Connectors

3. REQUIREMENTS

3.1. Safety

Do not stack product shipping containers so high that the containers buckle or deform.

3.2. Storage

A. Ultraviolet Light

Prolonged exposure to ultraviolet light may deteriorate the chemical composition used in the product material.

B. Shelf Life

The product should remain in the shipping containers until ready for use to prevent deformation to components. The product should be used on a first in, first out basis to avoid storage deterioration could adversely affect performance.

C. Chemical Exposure

Do not store product near any chemical listed below as they may cause stress corrosion cracking in the material.

Alkalis	Ammonia	Citrates	Phosphates	Sulfur Compounds
Acids	Amines	Carbonates	Nitrites	Sulfur Nitrites
				Tartrates



NOTE:

1) Resistance depends on chemical concentration, temperature, and exposure medium.

3.3. Characteristics

A. Part Numbering System

CONNECTOR

WEDGE

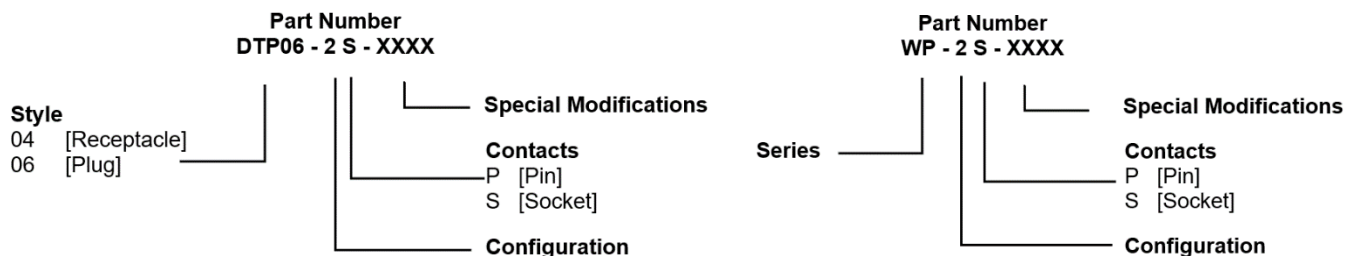

Note:

Pins used in receptacle and Sockets used in plug.

B. Pin Arrangement

See product drawing for contact cavity marking

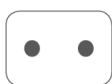

DTPO*-2*
2 size 12

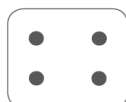



DTPO*-4*
4 size 12

C. Materials



Receptacle and Plug Housings:	PA66 GF15 (gray, black)
Caps:	PA66 GF15 (gray, black)
Flanges:	PA66 GF15 (gray, black)
Wedge Locks:	PBT GF30 (Orange)
Interface Seals:	VMQ (red-orange 2 pin, green 4 pin)
Grommets:	VMQ (red-orange)

D. Wedge Locks

Receptacle Wedge Locks

PN	Description	Shape and Color	
WP-2P	Wedglock for 2 pin		Orange
WP-4P	Wedglock for 4 pin		Orange

Plug Wedge Locks

PN	Description	Shape and Color	
WP-2S	Wedglock for 2 pin		Orange
WP-4S	Wedglock for 4 pin		Orange

E. Sealing Range

Conductor Range	Insulation OD Sealing Range in [mm]	Seal Type
10 -14 AWG [5.0 – 2.0 mm ²]	.134 - .170 [3.40 – 4.32]	N-Seal
	.097 - .158 [2.46 – 4.01]	E-Seal

F. Sealing Plugs

Open cavities provide pathways for contaminants to enter the connectors. To maintain seal integrity, any unused cavity must be filled with the appropriate size sealing plug.

Part Number	Material	Color	Description	Sealing Plug
114017	PBT	White	Sealing Plug	

G. Keying Pins

Keying pins are solid plastic rods used to prevent mis-mating of like connectors in close proximity. Keying pins are inserted into the retention fingers of an empty socket cavity. Once installed, the keying pin blocks a mating contact pin from being inserted. The contact pin will be blocked before the latch device mates the connectors, helping to prevent the mis-mating of like connectors. Proper usage requires that the corresponding mating pin to be omitted and a sealing plug be inserted in the rear cavity of the mating connector. Individual applications will vary, and testing should be done to determine the best arrangement to help prevent improper connector mating.

Part Number	Material	Color	Description	Sealing Plug
0413-214-1205	PBT	Yellow	Keying Pin N-Seal E-Seal	



NOTE:

- 1) Multiple keying pins may be required to help prevent unintentional forced mating.

H. Modification



NOTES:

- 1) Modifications include but are not limited to the following list.
- 2) Modifications listed are for reference only and may not be available for every arrangement.

Modification	Description	Plug	Receptacle
C015	Color: Gray Grommet Type: E-Seal Cap Type: None		
C017	Color: Gray Grommet Type: Blocked Cap Type: None		
CE01	Color: Gray Grommet Type: E-Seal Cap Type: Short		
CE02	Color: Black Grommet Type: E-Seal Cap Type: None		
CE03	Color: Black Grommet Type: E-Seal Cap Type: Short		
CE09	Color: Black Grommet Type: E-Seal Cap Type: Long		
E003	Color: Gray Grommet Type: N-Seal Cap Type: Short		

Modification	Description	Plug	Receptacle
E004	Color: Black Grommet Type: N-Seal Cap Type: None		
E005	Color: Black Grommet Type: N-Seal Cap Type: Short		
EE01	Color: Black Grommet Type: N-Seal Cap Type: Long		
L012	Color: Gray Grommet Type: N-Seal Cap Type: None Flange Type: Weld-On		
L025	Color: Gray Grommet Type: N-Seal Cap Type: None Flange Type: Molded-On		
LE07	Color: Gray Grommet Type: N-Seal Cap Type: Short Flange Type: Weld-On		

I. Accessories

Several accessory items can be used to complement the connectors such as PVC boots, plastic backshells, neoprene closed cell gaskets, protective dust caps and mounting clips. Accessories are designed to complete the application and meet a wide array of design requirements such as solutions for mounting, providing additional protection, and offering increased aesthetics.

BOOTS

Slip-on boots are not only aesthetically appealing, but also provide increased protection from dirt, paint overspray and pressure washing.

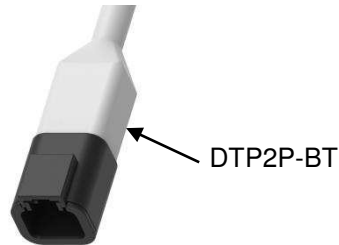

Part Number Receptacle	Description
DTP2P-BT	2 pin, Gray
DTP2P-BT-BK	2 pin, Black
DTP4P-BT	4 pin, Gray
DTP4P-BT-EN	4 pin, Gray, Long

Material: PCV

Operating temperature is -29°C to +100°C [-20° to +212°F].



NOTE:

- Boots are received with the end closed. Cut end of boot off to desired length.

BACKSHELLS

Designed to snap onto and mate with all standard plug without modifications that affect the rear of the connector. The rigid, durable backshells offer a high level of protection and allow corrugated tubing to nest within or outside the rear of the backshell. Straight version and right angle backshells are available. Since the backshells are designed to work with the standard connectors, tests should be conducted for fit and function of a backshell being used on any part with a modification.

Plug Backshell		
Connector Part Number	Corrugated tubing size (mm)	Part Number
DTP06-4S	16	180-DTP04
		A90-DTP04
		B90-DTP04
		A90-DTP04-952B
		B90-DTP04-952B



180-DTP04
2 REQD

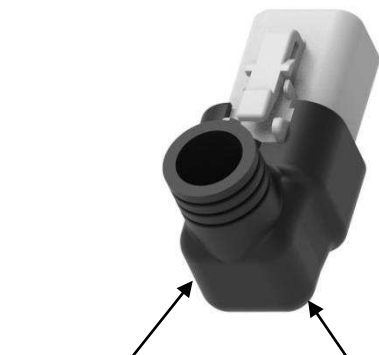

B90-DTP04 A90-DTP04



A90-DTP04-952B B90-DTP04-952B

GASKETS

Moisture, dirt, salt, sand, and road debris can all work their way into electrical panels through unsealed mounting flanges. These rugged high-quality gaskets form a splash proof seal between the panel face and connector flange to help keep out destructive elements. Gaskets are 3.18 [.125] thick.



Part Number	Connector Part Number
DTP4P-L012-GKT	DTP04-4P-L012 DTP04-4P-LE07

Material: Closed Cell Sponge.
 Operating temperature: -57°C to +107°C [-70° to +225°F]
 Gaskets are not IP rated

MOUNTING CLIPS

Mounting clips are installed on the receptacle to mount the connector. To meet design needs, the clips are available for several configurations and in plastic, stainless steel, or steel with zinc plating.

Part Number	Mounting Direction	Material	Plating Color	Mounting Hole	Cavity Arrangement
1027-003-1200	Straight	Stainless Steel	None	11 [.433]	2-pin 4-pin
1027-005-1200				13 [.512]	
1027-004-1200		Steel	Zinc/Yellow	5.08 [.200]	
1011-026-0205		PA66	Gray		
1011-030-0205			Black		
1011-310-0205 ² 1924484-2		Fir-Tree Mount			
1027-008-1200	Side	Steel	Zinc/Yellow	11 [.433]	
1027-017-1200				8.2 [.323]	



NOTES:

- 1) Zinc is RoHS compliant
- 2) Retention force is 89N [20 lbf] except 1011-310-0205 is 50N [11.2 lbf].



Straight Hole Mount

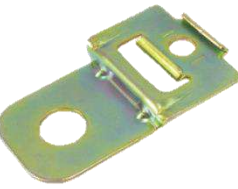

Slide Hole Mount



Hole Mount



T-Stud Mount



Fir-Tree Mount

3.4. Contact Insertion

1. The crimped contact must meet these specifications:

[114-151002](#) Application Specification for DEUTSCH Size 12 S&F Pin and Socket Contacts

[114-151006](#) Application Specification for DEUTSCH Size 4-20 Solid Pin and Socket Contacts

[114-151004](#) Application Specification for DEUTSCH Size 12 S&F Pin and Socket Contacts

- Grasp crimped contact approximately 25.4 [1.00] behind the contact crimp barrel and hold the connector with grommet facing you.
- Push contact straight into grommet until positive stop is felt. The contact will lock into place. A slight tug on wire will confirm that is properly locked in place.

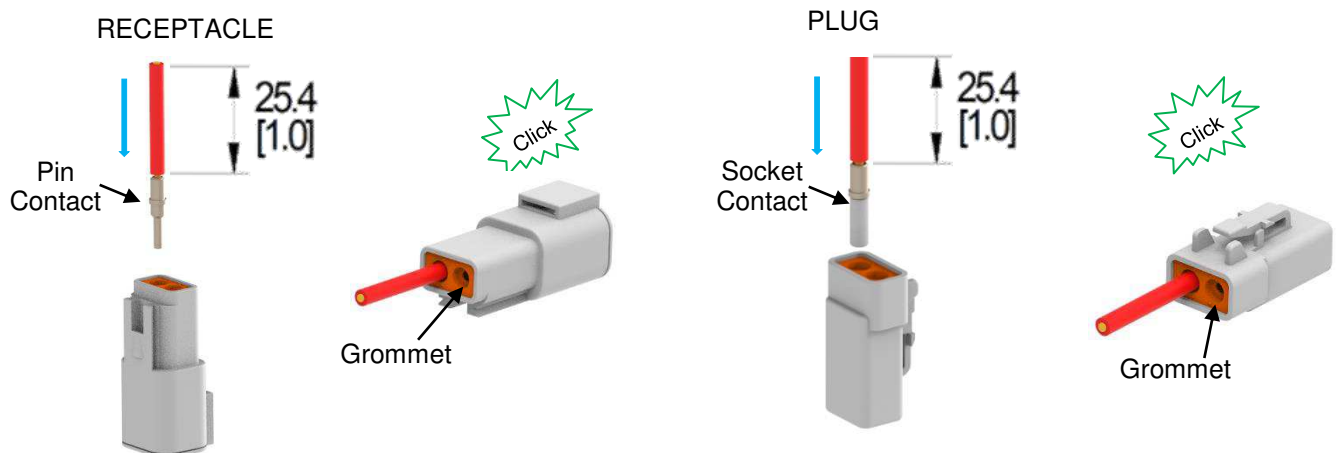

NOTE:

- Pins used in receptacle, sockets used in plug.*
- Wire insulation outside diameter must meet connector wire sealing range per section 3.3.E.*

- Once all the contacts are in place, insert the wedge lock until it snaps into place. For the receptacle, small long nose pliers may be used to assist in locking into place. For the plug, wedge lock may be locked in place by hand.

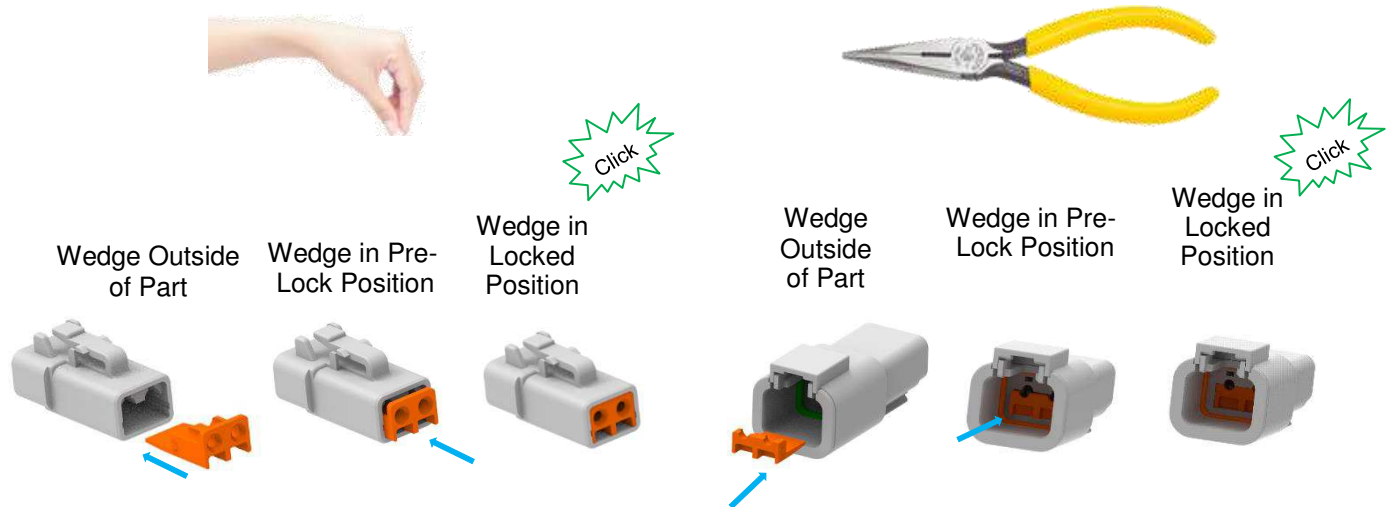

3.5. Contact Removal

DEUTSCH DT-RT1 multi-use tool has a small hook on one end for wedge lock removal and a small screwdriver on the other end to push back the locking fingers and release the contact. The tool is designed to extract individual DEUTSCH solid and stamped and formed (S&F) pin and socket contacts from front-release connectors. See [408-151008](#) for more information.

A. Removing Socket Contact

- Using small long nose pliers, grasp the wedge lock, then pull it straight out of the connector.

CAUTION: Be careful not to damage the inner ribs of the wedge lock if it is intended to be re-used.

- Insert the screwdriver tip of the removal tool into the contact cavity of the contact to be removed to release the locking finger.
- Pull the wire until the contact is removed. If there is no end cap on the connector, it may be necessary to hold the rear grommet in place with fingers while removing the contact.

Removing Socket Contacts

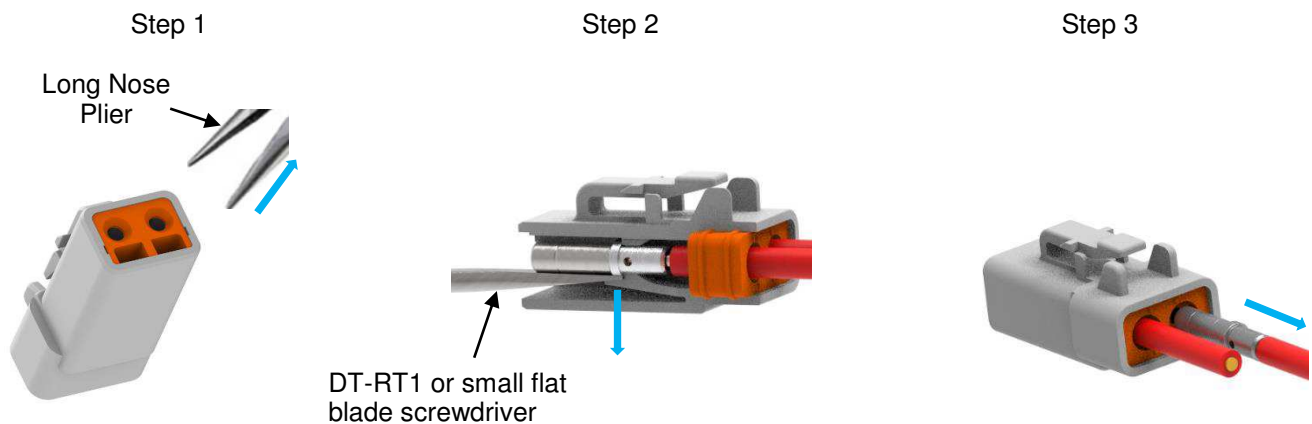

B. Removing Pin Contact

1. Using the small long nose pliers, grasp the wedge lock, then pull wedge straight out of the connector.
2. Insert the screwdriver tip of the removal tool into the contact cavity of the contact to be removed to release the locking finger.
3. Pull the wire until the contact is removed. If there is no end cap on the connector, it may be necessary to hold the rear grommet in place with fingers while removing the contact.

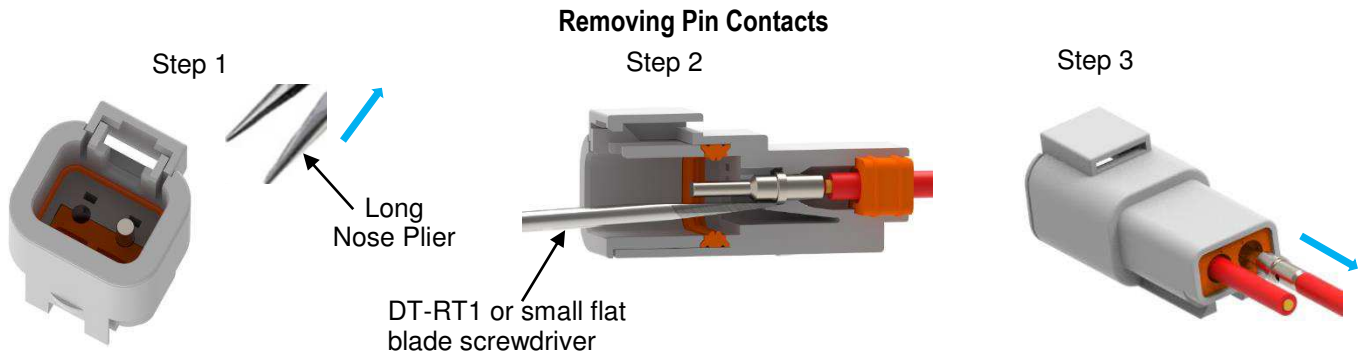

i *Note:*
If rear grommet comes out, inspect it for cuts, cracks or other damage. Replace if necessary. Reinstall

3.6. Sealing Plug and Keying Pin Installation and Removal.

Sealing Plug

Step 1:

Holding the sealing plug with large diameter end away from the connector, gently apply downward pressure to force the sealing plug into the cavity.



Step 2:

With perpendicular motion, apply downward pressure to the large diameter end of the sealing plug.

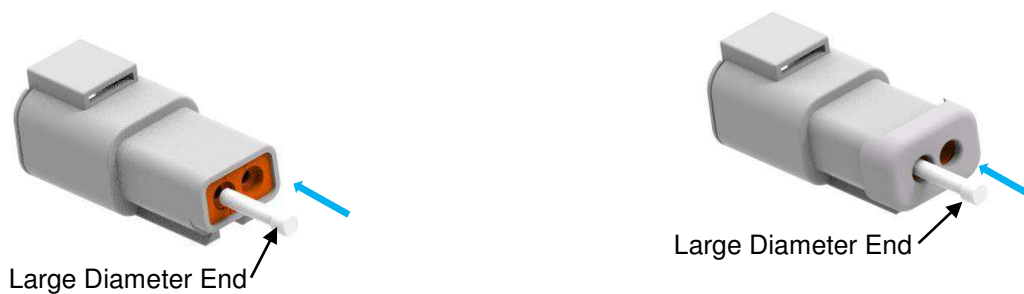

i *Note:*
The large diameter end must be flush with cavity opening. Do not push all the way through.

Step 3:

Apply pressure until sealing plug is forced to stop by contact with rear grommet. Visually inspect the sealing plug large diameter end to confirm it is flush with cavity opening. Do not push all the way through. Allowable distance from top of sealing plug to connector surface is shown below.



i Note:
Sealing plug may be used with long caps but may be difficult to remove.

Step 4:

To remove sealing plug from connector, grasp the large diameter end with fingers or small long nose pliers and pull until sealing plug is removed. If there is no end cap on the connector, it may be necessary to hold the rear grommet in place with fingers while removing the sealing plug.

i Note:
If rear grommet comes out, inspect it for cuts, cracks or other damage. Replace if necessary. Reinstall

Keying Pin (Used with Plug)

Step 1:

Holding the keying pin with large diameter end towards the connector, gently apply downward pressure to force the sealing plug into the cavity.

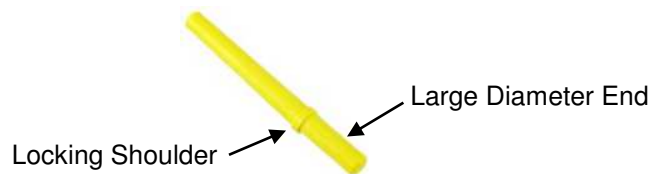

Step 2:

With perpendicular motion, gently apply downward pressure to the small diameter end of the Keying Pin.

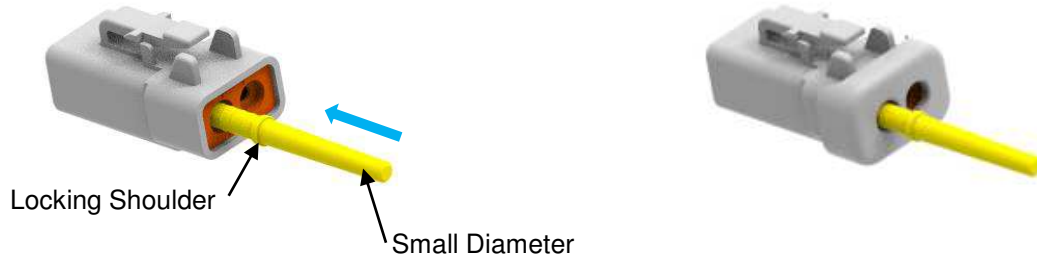

Step 3:

Apply pressure until sealing plug locks into place. A slight tug on the sealing plug will confirm it is locked into place. Allowable distance from top of sealing plug to connector surface is shown below.

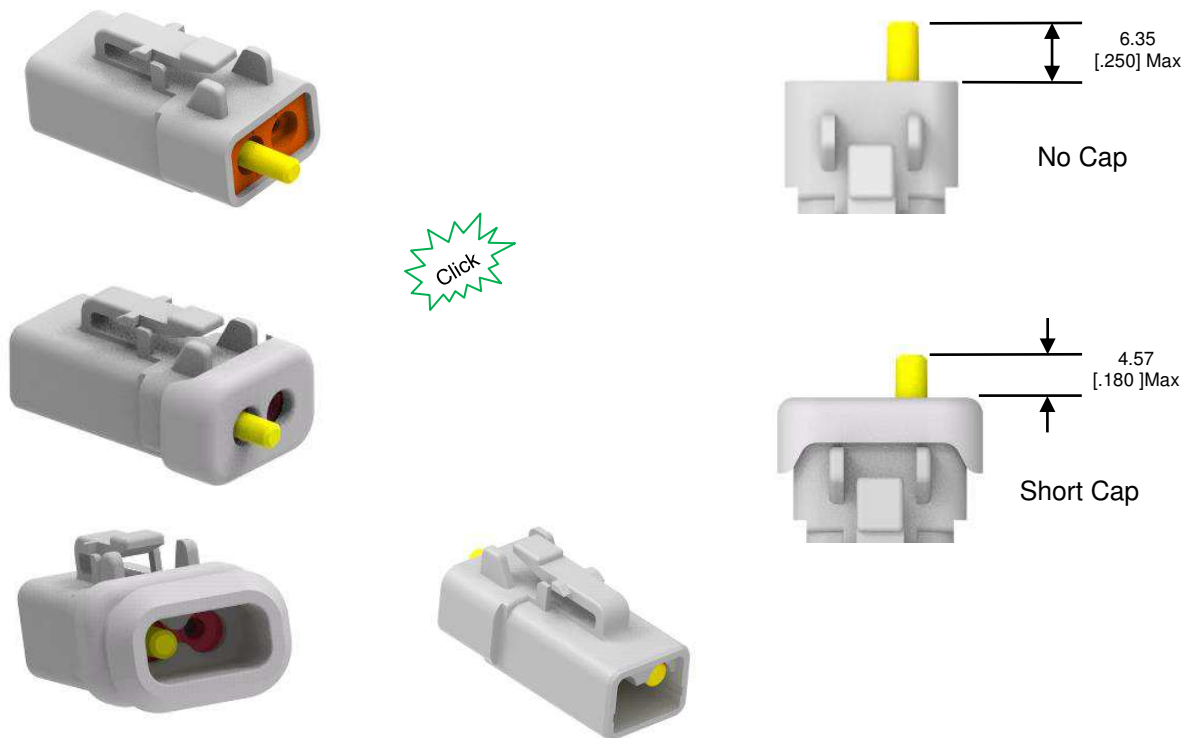

Step 4:

To remove keying pin from connector, first release the locking finger similar to step 2 of contact removal. Then, grasp the end of the keying pin with fingers or small long nose pliers and pull until it is removed. If there is no end cap on the connector, it may be necessary to hold the rear seal grommet in place with fingers during removal.



Note:

If rear grommet comes out, inspect it for cuts, cracks or other damage. Replace if necessary. Reinstall

3.7. Connector Mating

To mate the plug and receptacle align the plug latch with the receptacle latch box. Then push plug into the receptacle until there is an audible and tactile click. Verify plug latch is in full latched position.

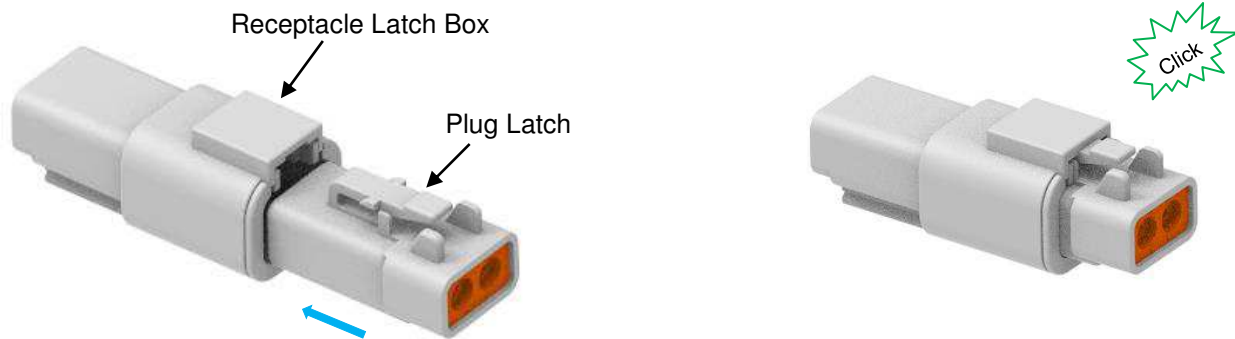

3.8. Connector Unmating

To un-mate the plug from the receptacle, push the plug latch until a hard stop is felt. Pull the plug from the receptacle until they are fully separated.

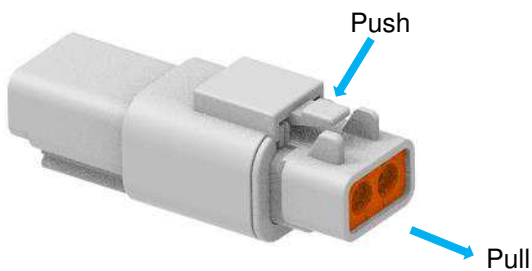

3.9. Backshell, Boot, Gasket, Protective Dust Cap, Mounting Clip Installation and Removal

See Section I for part numbers.

BACKSHELL - PLUG

1. To install the backshell, hold the backshell half as shown. Slide the second half backshell and align the snap and snap latch onto the back of the plug. 180-DTP04 shown as example.

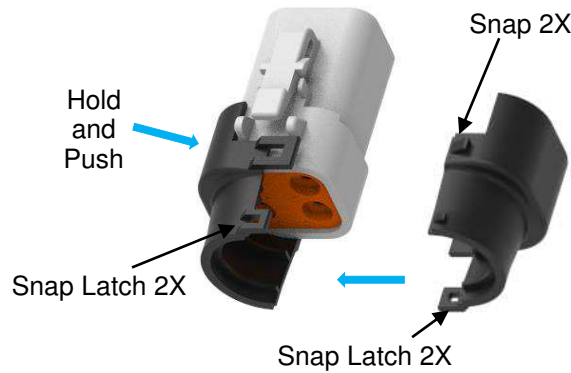

2. To close the backshell, bring the two halves together. Before snapping shut, make sure convoluted tubing (if used) is captured within the inner grooves. If no convoluted tubing is used, make sure no wires are pinched in the backshell. There are four snaps that need to engage in order to properly snap shut the backshell.

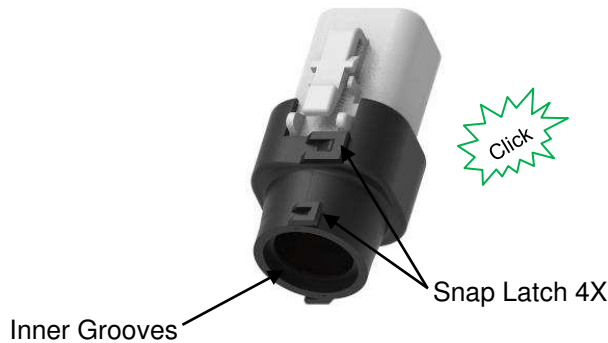

3. To open the backshell, disengage all snaps by wedging a [DT-RT1](#) tool or small flat head screwdriver under the snap latch, lift until disengaged, then remove backshell half. Remove the second backshell half.

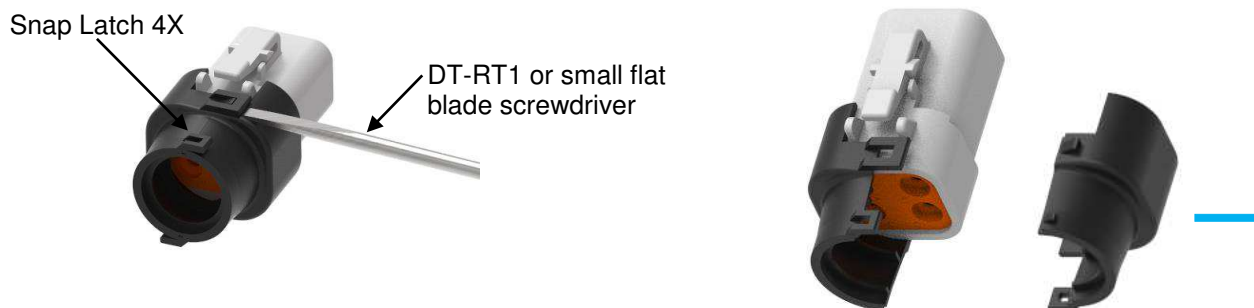

Caution:
Be careful not to break the snap latch.

BOOT

Step 1. Cutoff the end of the boot to desired length.

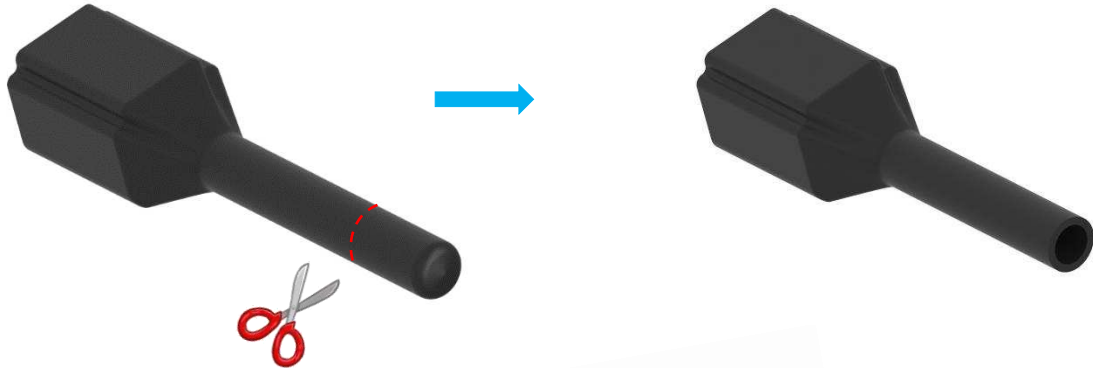

Step 2. Slide the boot over the wires.



Step 3. Insert the wires into the connector.

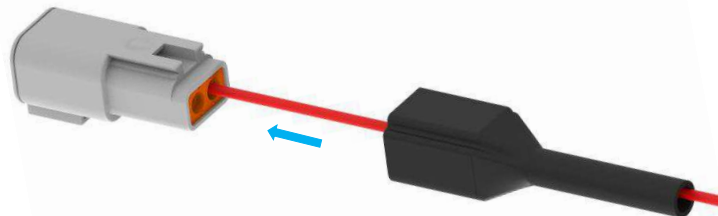

Step 4. Slide boot down the wires and onto the connector.



Step 5. If needed, attach a tie wrap on the end of the connector and boot. Trim tie wrap as needed.

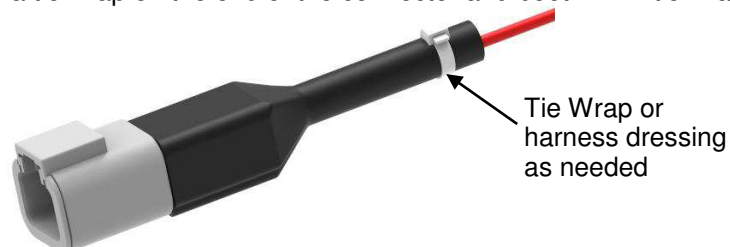

Note:

Do not put excessive stress on the boot to prevent boot from coming off connector.

GASKET

Install the gasket onto the connector on the desired side of the flange. Install on the front side for rear mount, on the back side for front mount. Next, install the connector with gasket into panel mounting hole. See section 3.10 for panel installation.



MOUNTING CLIP - RECEPTACLE

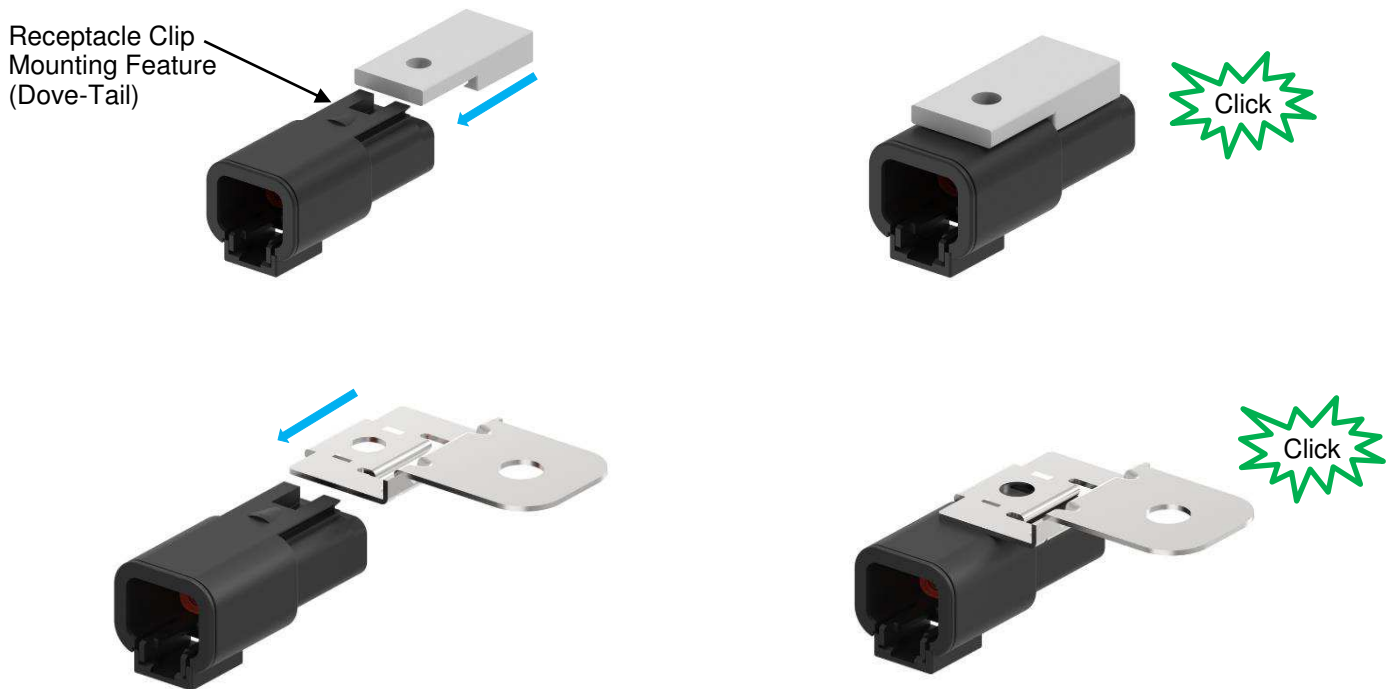

To install a clip onto a receptacle, first align the clip mounting features of the housing with the clip. Then push the clip straight onto the back of the connector until a positive stop and a snap is felt. Clip retention force is 89N [20 Lbf] minimum, except 1011-310-0205 is 50N [11.2 Lbf] minimum.



i Note: Mounting clip is removable. Damage to receptacle retention feature may occur.

3.10. Panel Installation

Receptacles with flanges may be mounted to a panel as shown. Refer to product drawings for panel cutout information. Recommended panel surface roughness is RMS 0.8µm [32µin] or better.

Modification	Description	Receptacle
L012	Includes a simple weld-on flange onto receptacle to simplify wire routing and assembly.	
L025	Includes an integrated flange into the receptacle with compression limiters and flange o-ring.	

FLANGE – L012 TYPE

Insert wire side of receptacle through the panel cutout for front mount or insert mating side of receptacle through the panel cutout for rear mount. If a gasket is used, ensure the gasket is installed onto the desired side of the flange before inserting connector through the panel cutout.

Recommended screw size is 8-32 [M4]. Screw length dependent on application. Recommended screw torque is 2.26-2.82 Nm [20-25 in-lb.]. Recommended mounting hardware (i.e. flat washers, nuts, screws) are customer supplied. Maximum recommended panel thickness is 6.35 [.250].

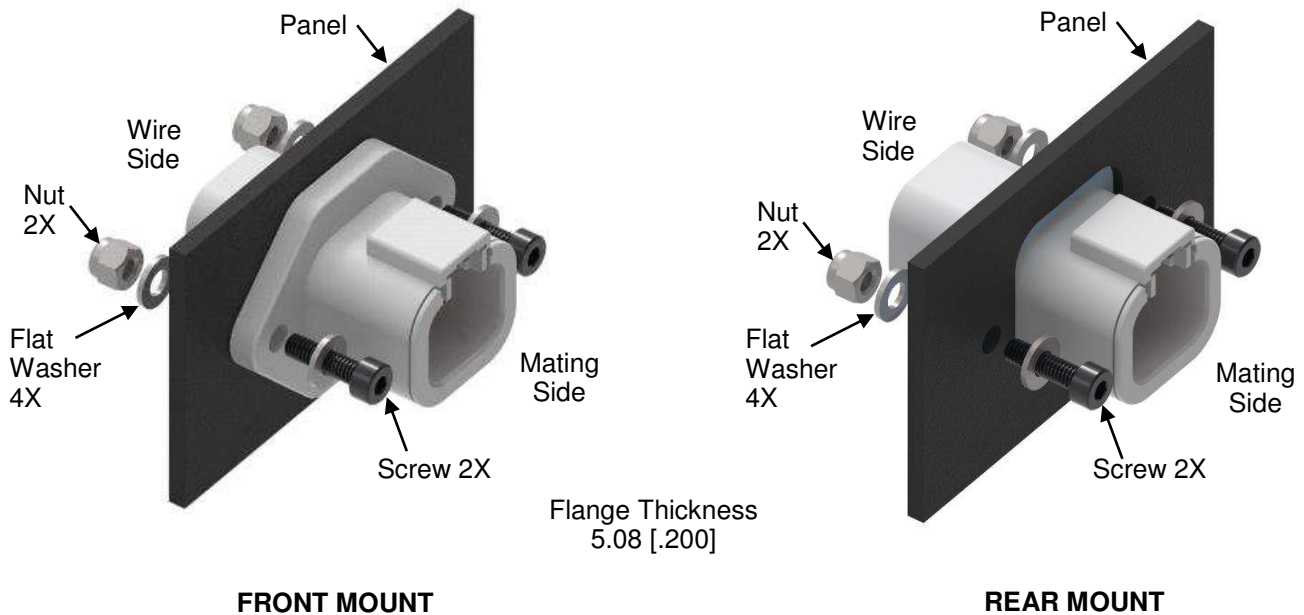

Note:

1. It is recommended to add flat washer under the head of the fastener and nut to prevent damage to flange.
2. Do not over tighten fastener. This will prevent damaged or broken receptacle and/or flange.
3. Do not side load the receptacle. This will prevent damage or broken receptacle and/or flange.
4. Weld-on flange is not sealed.
5. Optional gasket forms a dust/splash proof seal only, see Section I for more information.

FLANGE – L025 TYPE

Insert wire side of receptacle through the panel cutout.

Recommended screw size is M4 [6-32]. Length dependent on application. Recommended screw torque is 3.1-4.0 Nm [27.44-35.4 in-lb.]. Recommended mounting hardware (i.e. flat washers, screws) are customer supplied.

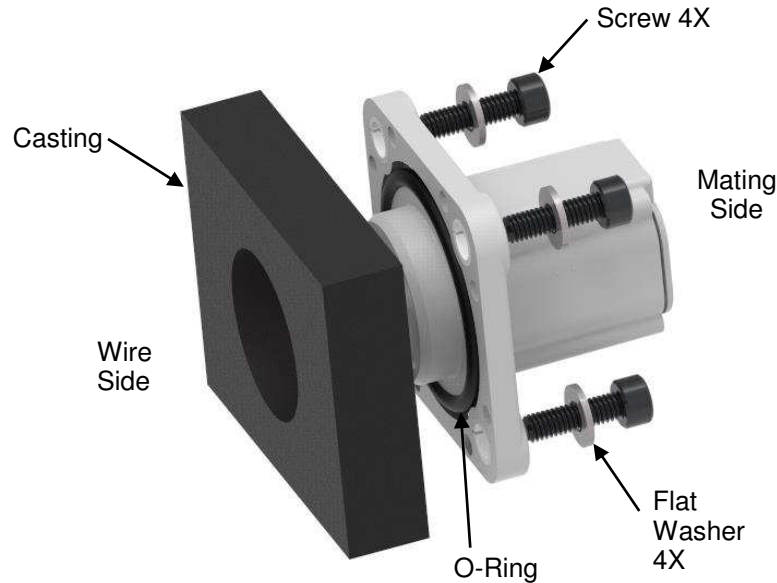

NOTE:

- 1) *It is recommended to add a flat washer under the head of the fastener.*
- 2) *Do not over tighten the fastener. This will prevent damaged or broken receptacle and/or flange.*
- 3) *Do not side load the receptacle. This will prevent damaged or broken receptacle and/or flange.*

3.11. Replacement and Repair

Damaged or defective connectors must not be used. These connectors cannot be repaired.

4. QUALIFICATION

Refer to product specification [108-151012](#) for qualification and approved agency.

5. TOOLING

Refer to the following application specifications for reference on all pin and socket contact termination tooling.

- [114-151002](#) Application Specification for DEUTSCH Size 12 S&F Pin and Socket Contacts
- [114-151004](#) Application Specification for DEUTSCH Size 4-20 Solid Pin and Socket Contacts
- [114-151006](#) Application Specification for DEUTSCH Size 12 S&F Pin and Socket Contacts

[DT-RT1](#) removal tool is designed to be used to service the connector.



DEUTSCH Removal Tool [DT-RT1](#) for Front-Release Connectors ([408-151008](#))

6. HELPFUL HINTS

Helpful hint

Proper wire outside diameters help provide water tight seal. See section 3.3.E for sealing ranges.

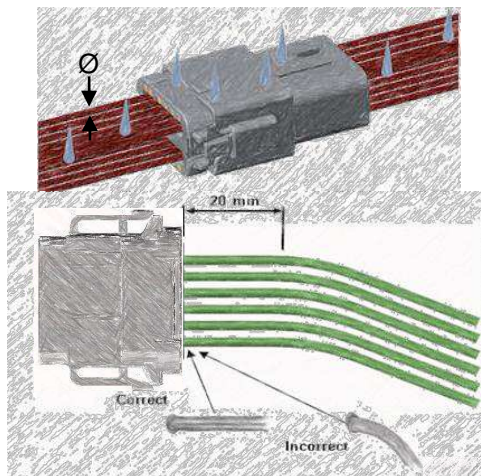

Helpful hint

Proper wire routing assures water tight seal performance. Keep wire straight for 20mm minimum recommended, unless a plastic back shell is used.

Helpful hint

Making the socket contact side the “hot side” can reduce the danger of electric shock.



Helpful hint

Pulling lightly on the wire after it is snapped in place will assure the contact is locked.

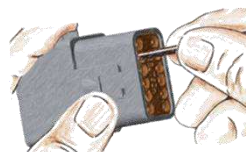

Helpful hint

Sealing plugs are used to seal the connector when all the cavities are not used by wires.



Helpful hint

Mounting connectors horizontally allows proper water drainage.

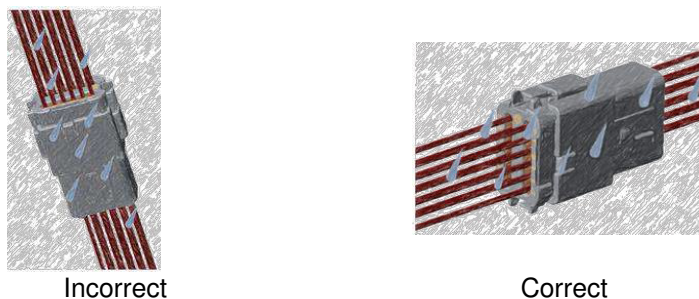

Helpful hint

Attaching the connector to a structure eliminates straining the electrical system in service.

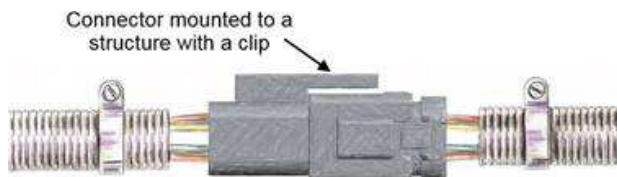

Helpful hint

Tie wraps and tape away from the rear of the connector will allow the wire to be sealed properly.

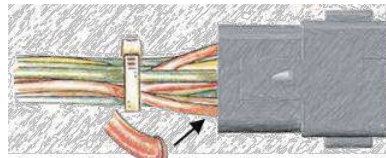

Incorrect

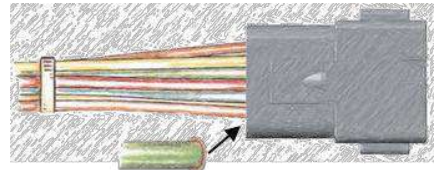

Correct

7. VISUAL AID

Below shows a typical application of the DTP Series Connector. This illustration should be used by production personnel to ensure a correctly applied product. Applications which DO NOT appear correct should be inspected using the information in the preceding pages of this specification and in the instruction, material shipped with the product or tooling.

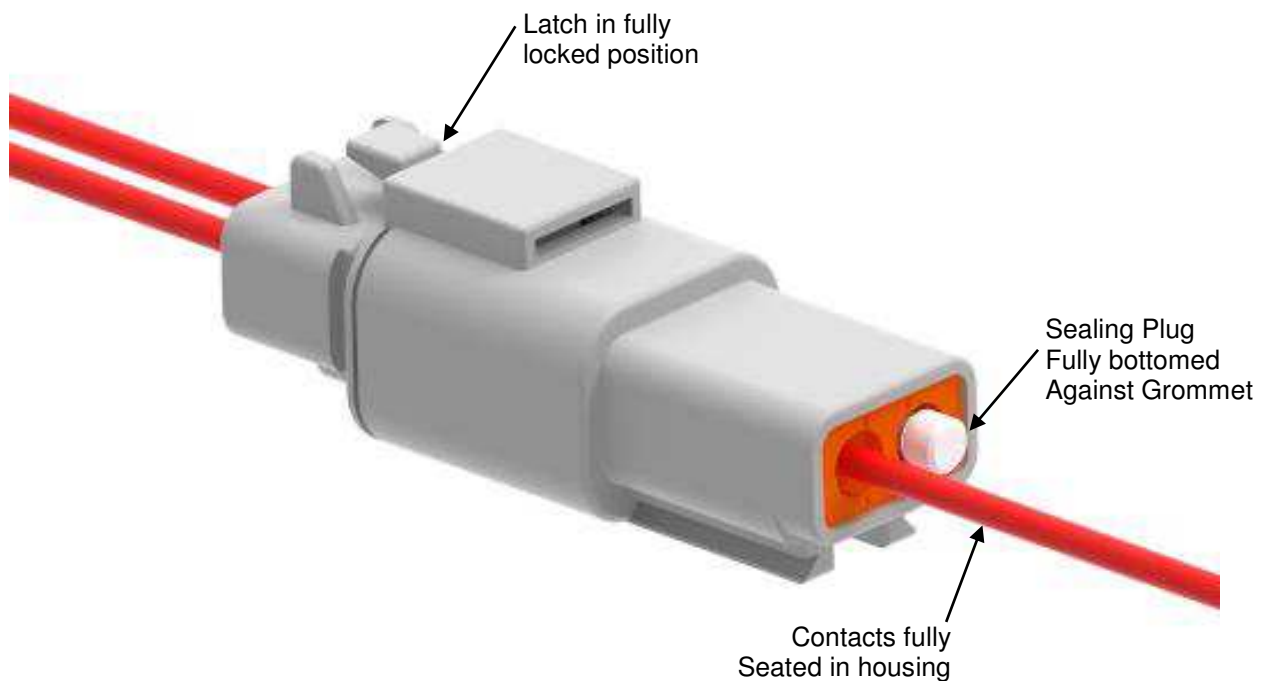

8. REVISION HISTORY

Rev	Brief Description of Change	Date	Dwn	Apvd
A	Initial Release	08/26/2020	DM	IG