Docking Frame Series

Table of contents

1. INTRODUCTION	2
2. SUPPORTING DOCUMENTS	2
2.1. Customer drawings	2
2.2. Product specification	2
2.3. Application Specification	2
2.4. Standards	2
3. DESCRIPTION	3
3.1. Assembly product	3
3.2. Types	4
3.2.1. Docking Frame	4
3.2.2. Float washer	4
4. REQUIREMENTS	5
4.1. Panel cut-out	5
4.2. Space of two Panels at close status	5
5. ASSEMBLY	6
6. STORAGE	8

1. INTRODUCTION

This specification contains the regulations for assembly of various Docking Frame.

The following components are available in this system:

Frame: H6BP-T2-M/F, H10BP-T3-M/F, H16BP-T4-M/F, H24BP-T6-M/F.

Float Washer

2. SUPPORTING DOCUMENTS

2.1. Customer drawings

For dimensions and materials of the individual parts, please refer to the relative customer drawings of H6BP-T2-M/F, H10BP-T3-M/F, H16BP-T4-M/F, H24BP-T6-M/F and Float Washer.

2.2. Product specification

The product specifications of the used articles are to be taken into account. The product specification describes the technical data as regulations, temperature range and degree of protection. For further reference, please refer to product spec. 108-137168.

2.3. Application Specification

Connectors shall be assembled as below mentioned TE application specifications to ensure correct connector assembly.

2.4. Standards

- EN 61984: Connectors - Safety requirements and tests
- EN 60068: Environmental testing

3. DESCRIPTION

3.1. Assembly product

The following picture (Figure 1) shows an example of complete assembly product.

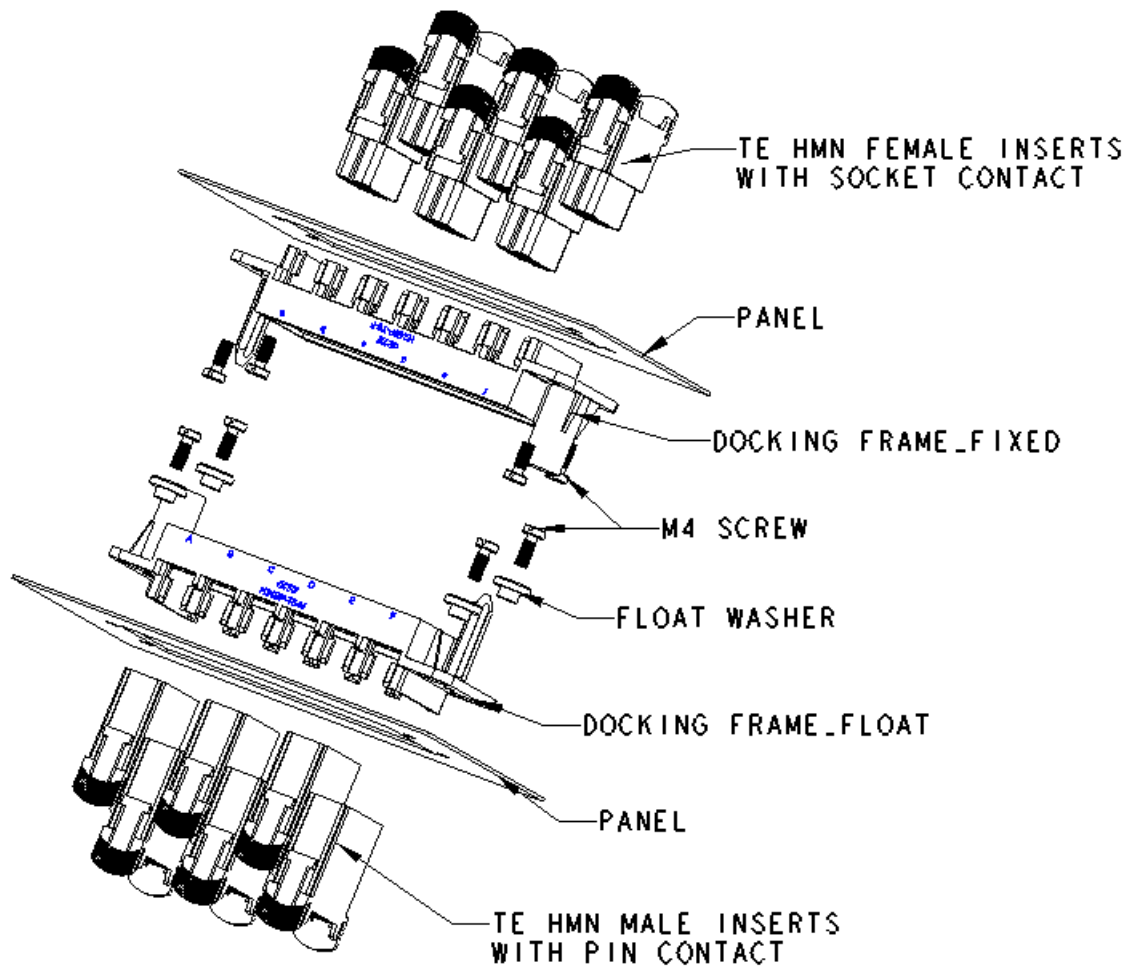

Figure: 1

The complete product consists of the following components (see figure 1):

- Docking frame _ float
- Float washer
- Docking frame _ fixed
- M4 screw
- TE HMN Male inserts with pin contact
- TE HMN Female inserts with socket contact

3.2. Types

3.2.1. Docking Frame

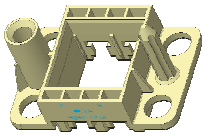
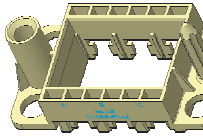
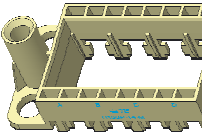
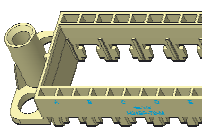
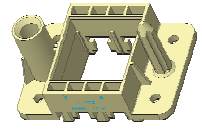
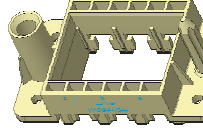
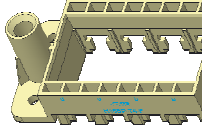
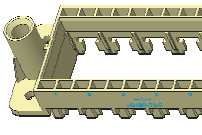
Type	2 modules	3 modules	4 modules	6 modules
Float				
	H6BP-T2-M	H10BP-T3-M	H16BP-T4-M	H24BP-T6-M
Fixed				
	H6BP-T2-F	H10BP-T3-F	H16BP-T4-F	H24BP-T6-F

3.2.2. Float washer

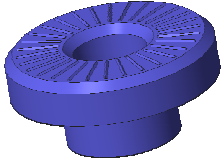
Float washer	
--------------	---

4. REQUIREMENTS

4.1. Panel cut-out

For information concerning the panel cut-out for the use of docking frame on panels as shown in Figure 2 and Table 1. Information also can be found from related customer drawings.

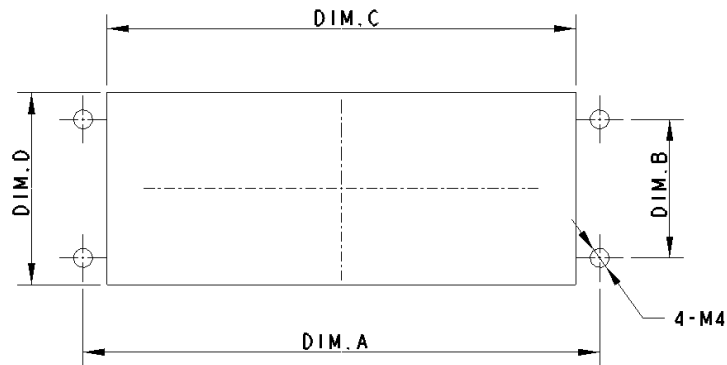

Figure: 2

Type	DIM.A	DIM.B	DIM.C	DIM.D	Hole
H6BP-T2-M/F	48.6	28.8	38.6	40	For M4 screw
H10BP-T3-M/F	63.3	28.8	53.3	40	For M4 screw
H16BP-T4-M/F	78	28.8	68	40	For M4 screw
H24BP-T6-M/F	107.4	28.8	97.4	40	For M4 screw

Table: 1

4.2. Space of two Panels at close status

For information concerning the space of two panels at close status as shown in Figure 3.

Information also can be found from related customer drawings.

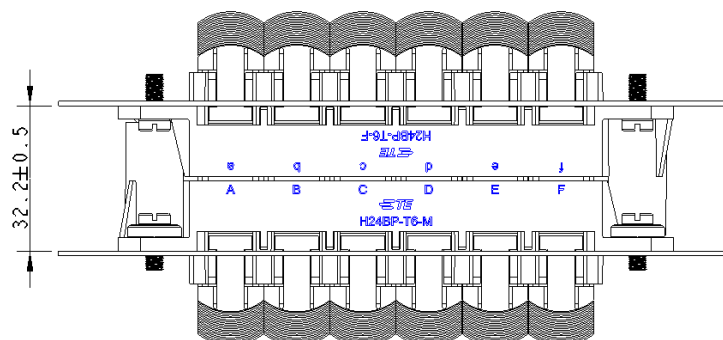

Figure: 3

5. ASSEMBLY

➤ Assembly male insert into docking frame_float

The process of assembling the male inserts without any mismatch and difficulty. This is done with the help of structures which are present on both the male insert as well as dock frame. As shown in figure 4.

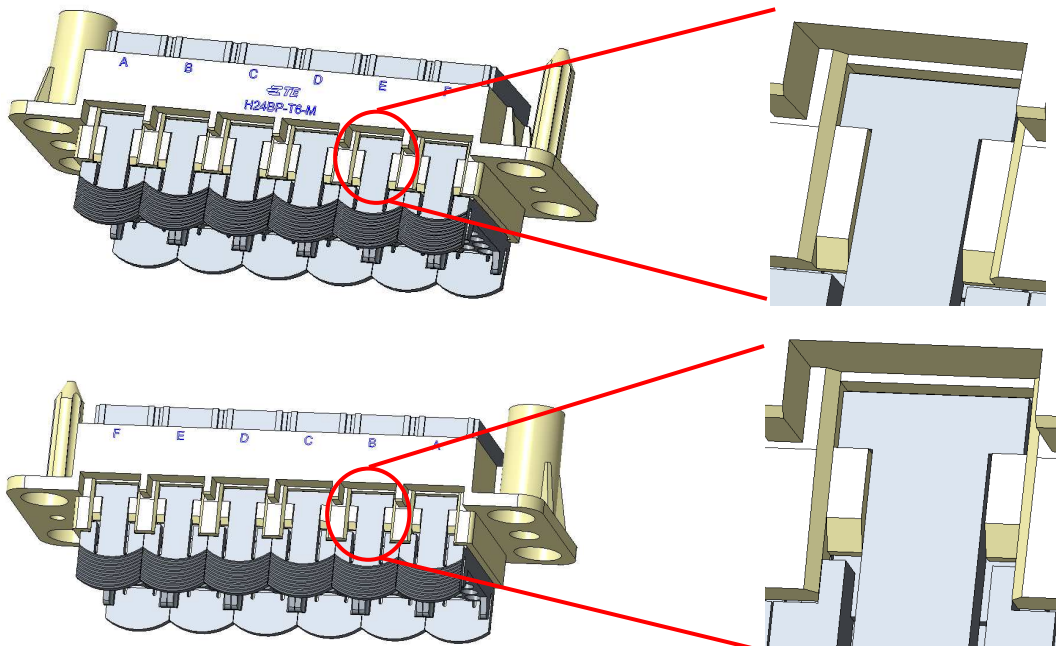

Figure: 4

Note:

- Refer application spec of male insert separately and before fixing into frame, male insert should be well prepared.
- Whatever the type of frame or the type of male insert, they have same assembly process here.

➤ Assembly docking frame_float on panel

Fix frame with 4 float washers and 4 M4 screws as shown in figure 5. Tightening torque refer to spec of screws, but no less than 2Nm.

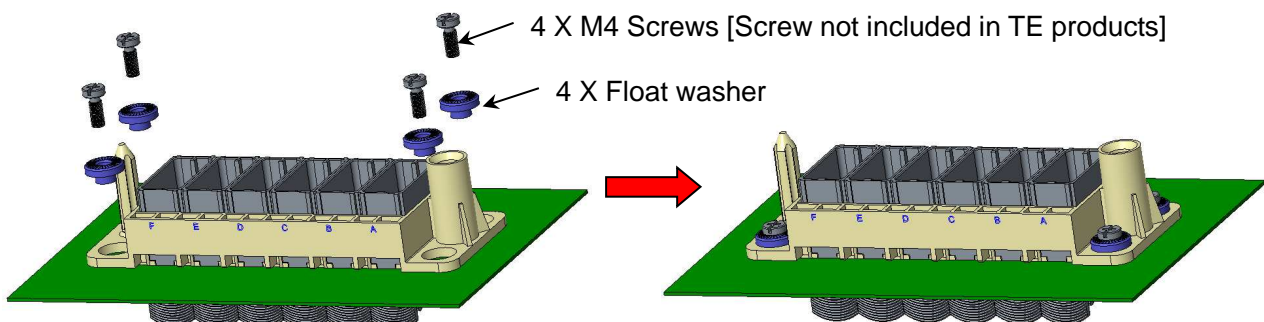

Figure: 5

➤ **Assembly female insert into docking frame_fixed**

The process of assembling the female inserts without any mismatch and difficulty. This is done with the help of structures which are present on both the female insert as well as dock frame. As shown in figure 6.

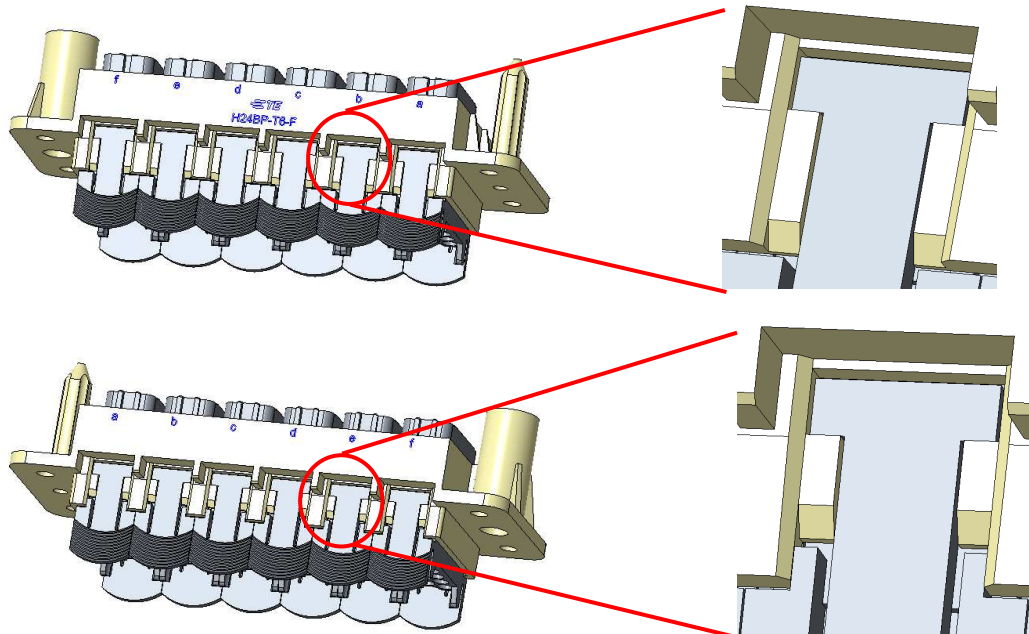

Figure: 6

Note:

- Refer application spec of female insert separately and before fixing into frame, female insert should be well prepared.
- Whatever the type of frame or the type of female insert, they have same assembly process here.

➤ **Assembly docking frame_fixed on panel**

Fix frame with 4 M4 screws as shown in figure 7. Tightening torque refer to spec of screws, but no less than 2Nm.

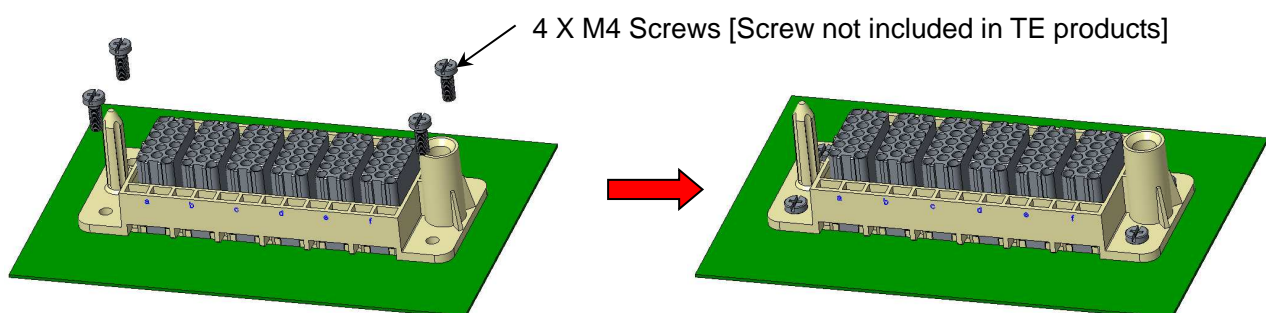

Figure: 7

6. STORAGE

The connectors should be stored in the air ventilation, no corrosive gas, no rain and no snow in the warehouse. Relative humidity: less than 85% RH.



Any conflict is found between this file and customer drawings, customer drawings are preferential. And please contact TE Connectivity related engineer if necessary.