



HMN-012-M and HMN-012-F Insert Series

Table of contents

1. INTRODUCTION	2
2. SUPPORTING DOCUMENTS	2
2.1. Customer drawings	2
2.2. Product specification	2
2.3. Application Specification	2
2.4. Standards	2
3. DESCRIPTION	3
4. REQUIREMENTS	4
4.1. Wire selection and preparation	4
4.1.1. Stripping length L	4
4.1.2. Insulation diameter	4
4.2. Assemble wires to inserts	5
4.2.1. Inserts of crimp termination (HMN-012-M/F)	5
5. ASSEMBLY	8
5.1. Contact inserts	8
5.2. Grounding	9
5.3. Marking	10
5.4. Polarization function	10
6. STORAGE	11
6.1. Chemical exposure	11
6.2. Storage condition	11



1. INTRODUCTION

This specification contains the regulations for assembly of HMN-012-M/F contact inserts and the handling of these inserts.

2. SUPPORTING DOCUMENTS

2.1. Customer drawings

Please refer to the customer drawings of HMN-012-M/F insert series.

2.2. Product specification

The product specifications of the used articles are to be taken into account. The product specification describes the technical data as e.g. regulations, approvals, temperature range and rated voltage.

For further reference refer Product spec. 108-137121.

2.3. Application Specification

Connectors shall be assembled as below mentioned application specifications to ensure correct connector assembly.

2.4. Standards

- EN 61984: Connectors - Safety requirements and tests
- IEC 60664-1: Insulation coordination for equipment within low-voltage systems (Part 1)

3. DESCRIPTION

This application specification describes the male module insert and the female module insert of the HMN-012-M/F series.

The listed terms are used in the specification as shown HMN-012-M/F with H24BN module frame as example in figure 1.

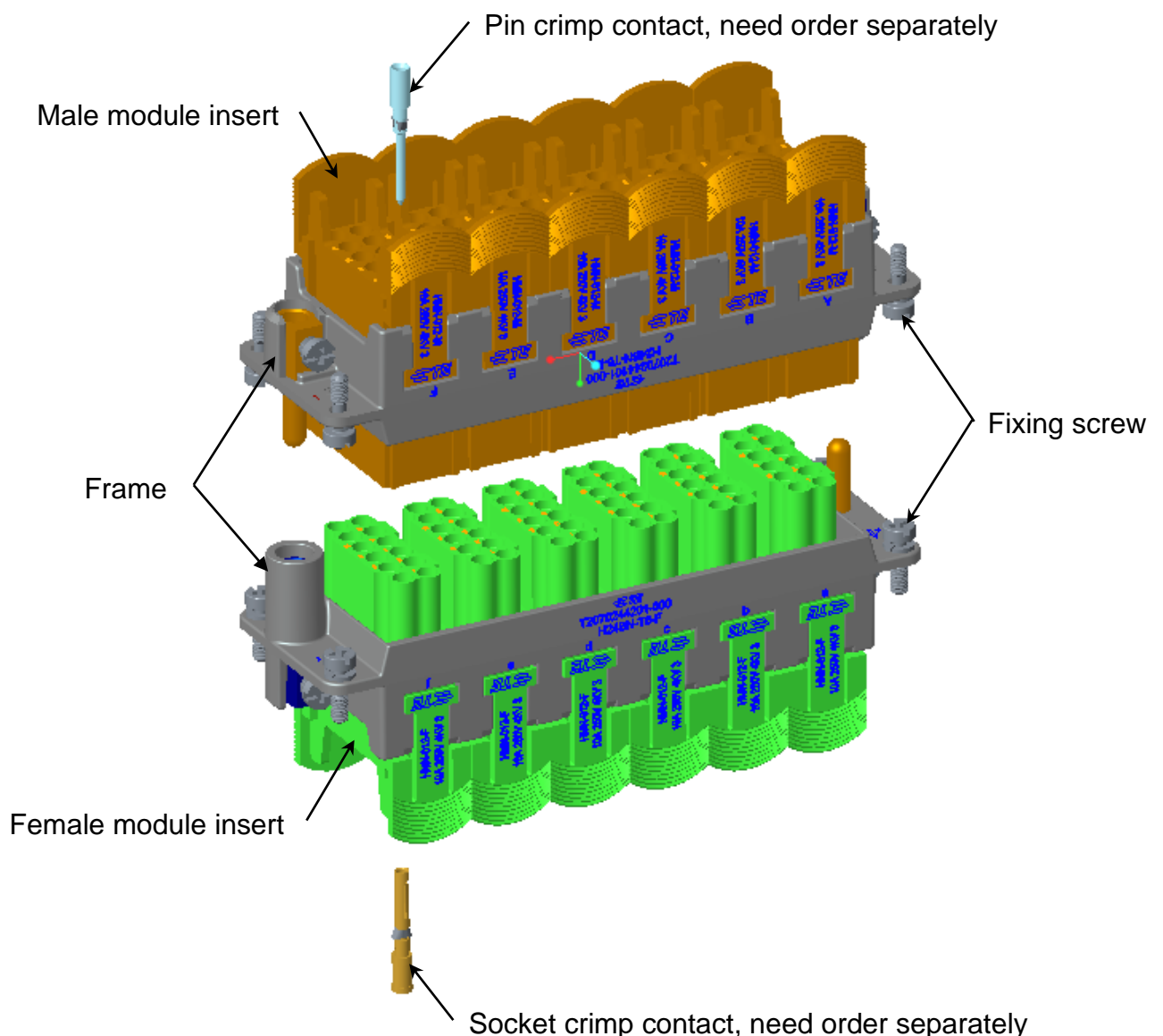

Figure: 1

4. REQUIREMENTS

4.1. Wire selection and preparation

4.1.1. Stripping length L

Use proper tooling to strip the wire.

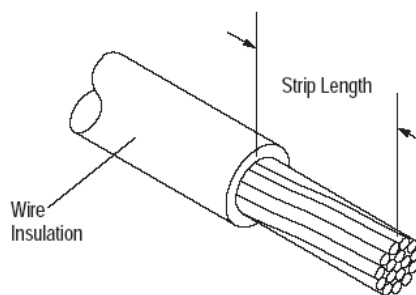

Figure: 2



When stripping the wire, care must be taken to avoid scraping, nicking, or cutting the conductor. Care must also be used when handling the wire during stripping to prevent cracking or breaking the conductor and insulation.

Depending upon the cross section of the wire or cable, the stripping length has to be selected from the table below. See Table 1.

Table: 1

Contact Insert	Max. Wire cross section		Strip Length For Reference	Voltage Rating
	[mm ²]	AWG	L [mm]	
HMN-012	≤2.5 mm ²	14	6	10A/ 250V

4.1.2. Insulation diameter

Any wire that is used for the Electrical purpose is covered with insulating polymer. This insulation on the wires depends upon the wire size and type of application where it is being used.

4.2. Assemble wires to inserts

4.2.1. Inserts of crimp termination (HMN-012-M/F)

- a. Assemble stripped wires to contacts (Crimp)

➤ Crimping tool

Crimping tool is available as below Figure 3 &4:



- ♦ Wire range: 26AWG ~ 12AWG (0.14 mm² ~ 4.0 mm²)
- ♦ Type: RPC-M23-T-B
- ♦ Order number: T3100000022-000

Figure: 3



- ♦ Wire range: 26AWG ~ 12AWG (0.14 mm² ~ 4.0 mm²)
- ♦ Type: CRIMPBOX-0.5/4
- ♦ Order number: T3100000001-000

Figure: 4

➤ Crimp

Insert the cable - stripped according to Table 1 - into the wire barrel of the contact. The wire strands must be visible in the reference hole of the contact. Afterwards, crimp the contact in the crimp area, using the correct tool for this type of contact. During the termination process make sure that the contact in the contact zone is not damaged or deformed.

When using manual crimp tools the following points must be followed:

- 1). Equip manual crimp tool with the correct locator or positioning ferrule.
- 2). When using different manual crimping tools the pliers have to be adjusted by plug gauge to fit the crimp area.
- 3). Fully insert contacts into the locator.
- 4). Clamp the wire with help of crimp tool. Note that to press the crimp tool till the stopper is reached a positive crimp.

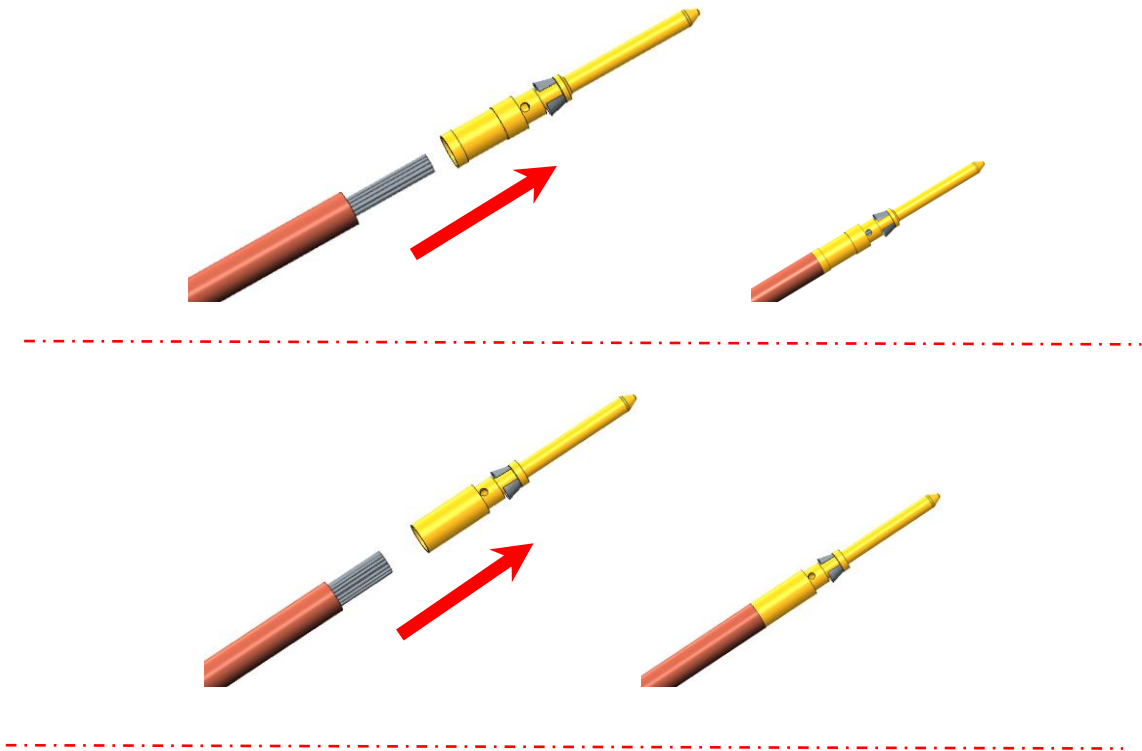

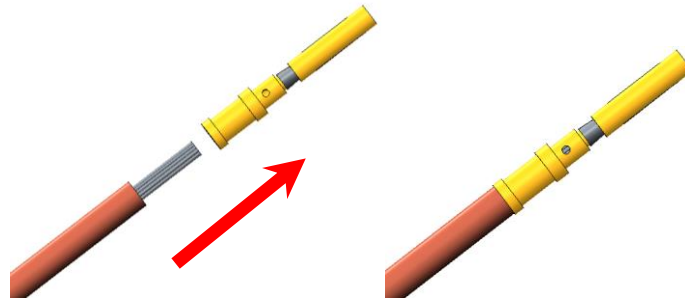

Figure: 5



For more detailed information, please refer to related contacts customer drawing.

b. Insert crimped terminals into module inserts

The crimped terminals are plugged into the module insert by gently pushing it into the required position until the contact is locked by the inserts, a click should be heard normally.

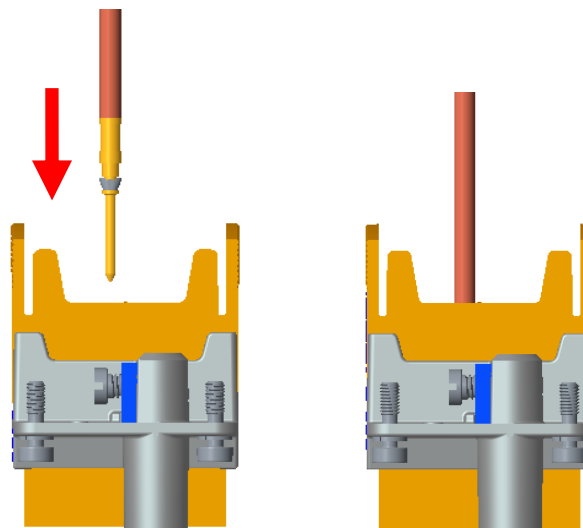

Figure: 6

5. ASSEMBLY

Assembling the contact inserts for both Male & Female connector has to be carried out with proper tools.

5.1. Contact inserts

The contact inserts are screwed into a corresponding hood or housing by fixing screws M3. The torque is 0.5Nm for reference.

Note: * The distance for safe contact of the contact inserts is max. 21mm. See figure 7.

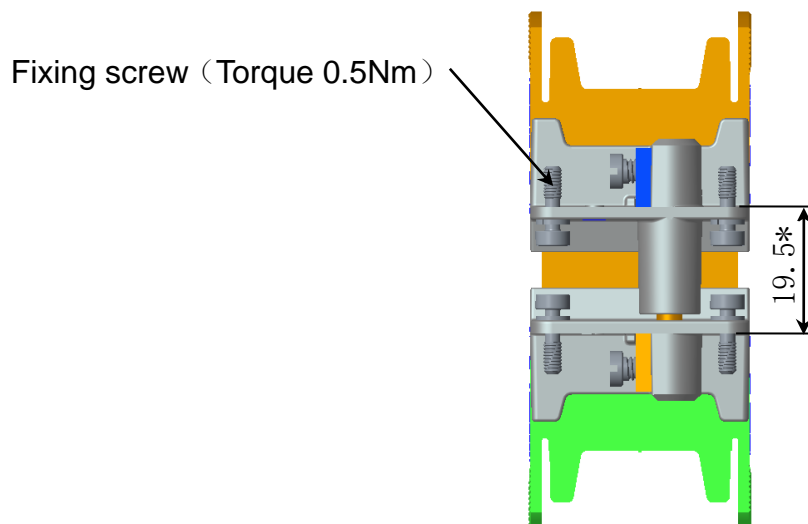

Figure: 7

5.2. Grounding

This clamping point is suitable for connection of a cable with a nominal cross section of up to 4 mm². Earthing is to be executed according to IEC 61984. The strip length of cable for PE connection: 8+/-0.5 mm.

Ferules and blade terminals can be used for ground connection.

Tighten torque are shown in below table 2 as reference.

Table: 2

Wire gauge (mm ²)	1.5	2.5	4
Tighten torque (Nm)	0.5	0.5	0.8
Min. pull-out for stranded wire (N)	40	50	60

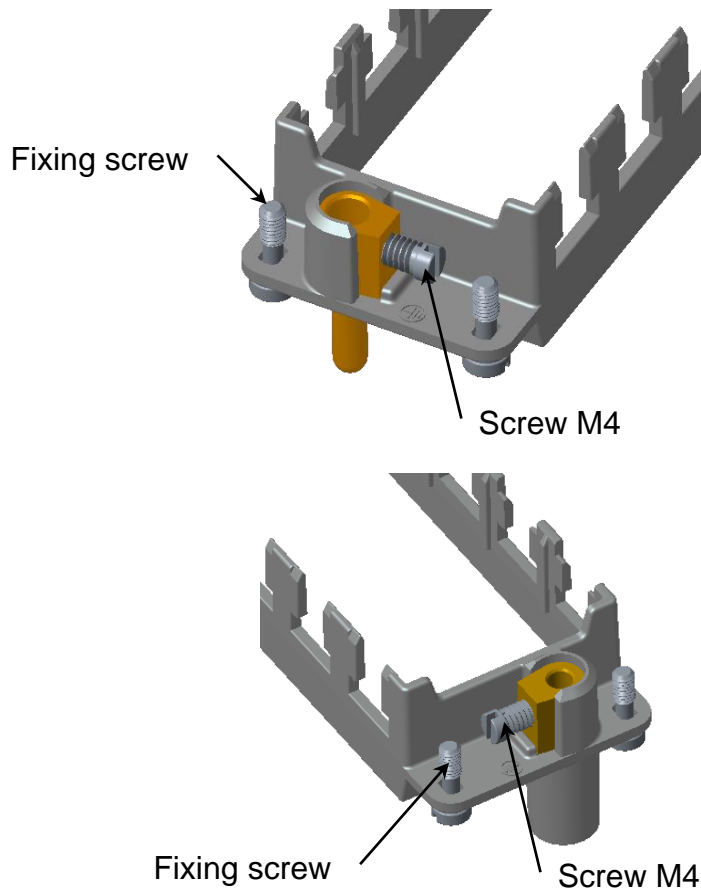

Figure: 8

5.3. Marking

The connector type, rating and the number of position etc. refer to the corresponding HMN-012-M/F module insert customer drawings.

5.4. Polarization function

The process of assembling the male and female module inserts without any mismatch and difficulty calls for polarization. This is done with the help of ribs or slots and which are present on both the male module insert as well as the female module insert. As shown in figure 9.

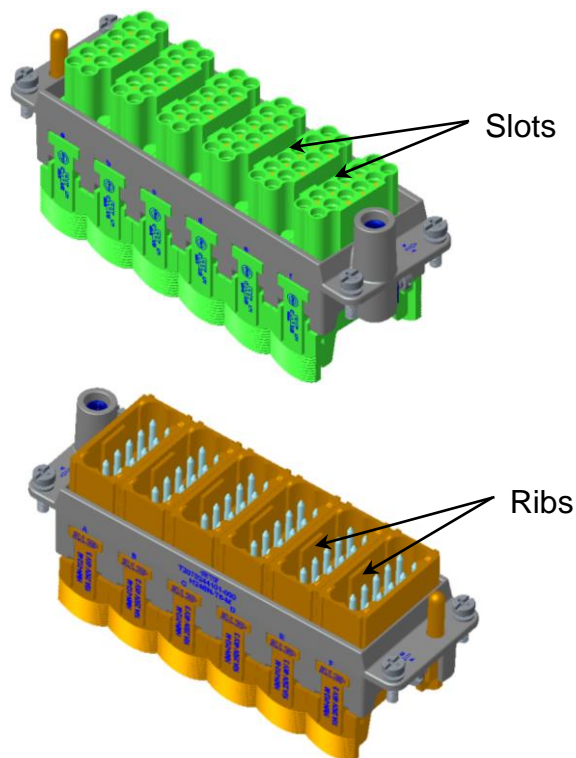

Figure: 9



6. STORAGE

6.1. Chemical exposure

Do not store the connectors near any chemical listed below as they may cause corrosion stress the connector contacts:

Alkalies, Ammonia, Citrates, Phosphates, Citrates, Sulfur, Amines, Carbonates, Nitrites, Sulfides, Nitrites, Tart rates.

6.2. Storage condition

The connectors should be stored in the air ventilation, no corrosive gas, no rain and no snow in the warehouse. Relative humidity: less than 85% RH. The connectors should remain in the shipping containers until ready for use to prevent deformation to the contacts. The connectors should be used on a first in, first out basis to avoid storage contamination that could adversely affect electrical functions.

-----END-----