



All numerical values are in metric units [with U.S. customary units in brackets]. Dimensions are in millimeters [and inches]. Unless otherwise specified, dimensions have a tolerance of ± 0.13 [± 0.005] and angles have a tolerance of $\pm 2^\circ$. Figures and illustrations are for identification only and are not drawn to scale.

1. INTRODUCTION

This specification covers the requirements for application of Power Series 50 connector assemblies in high-current systems for power supplies, battery chargers, telecommunications, and material handling equipment. The connector assembly consists of a hermaphroditic housing and two closed barrel contacts.

The contacts are available in sizes 6, 8, and 10-12 and accept wire sizes (AWG) that correspond to the contact size. Reducing bushings are available for contact size 6 to accommodate smaller wire sizes to a minimum of size 16 AWG. These contacts feature a flared wire barrel and round-ended tab. The contacts are available in loose-piece for terminating with manual or pneumatic hand-held tools and in reeled form for terminating with semi-automatic machines.

The housing features two contact cavities each marked on top of the housing with a plus (+) to indicate positive polarity and a minus (-) to indicate negative polarity. Each contact is held in the cavity by an internal retaining spring. The hermaphroditic design of the housing ensures proper polarity in mating of the connectors. In addition, the housings are color coded to provide visual reference for proper mating and a molded-in mechanical key at the mating face prevents inadvertent mating of different colored housings (housings with same position keys will only engage housings of the same color). The housing color is also coded for recommended application voltage.

When corresponding with personnel, use the terminology provided in this specification to facilitate your inquiries for information. Basic terms and features of this product are provided in Figure 1.

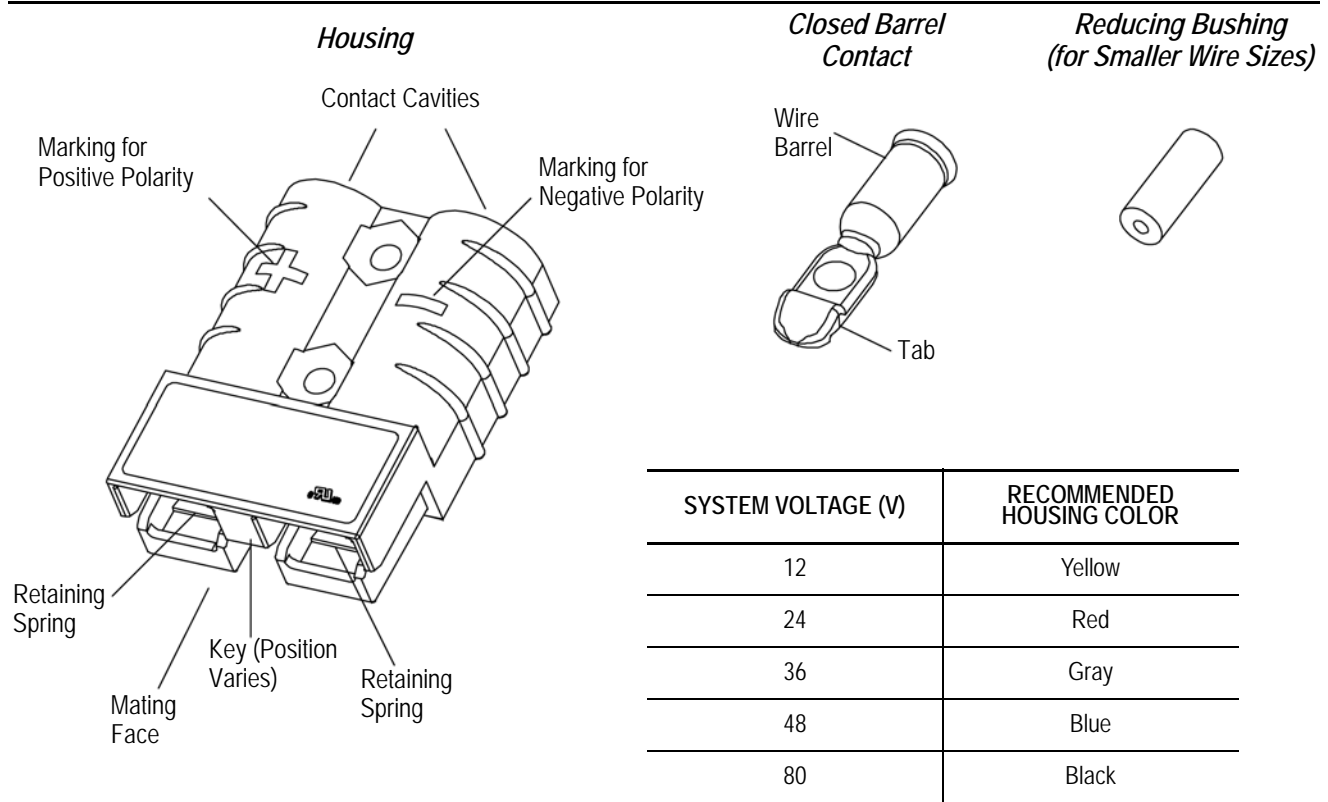

Figure 1

2. REFERENCE MATERIAL

2.1. Revision Summary

Since the previous release of this application specification, the new company logo has been applied.

2.2. Customer Assistance

Reference Product Part Number 647845 and Product Code G802 are representative of Power Series 50 connector assemblies. Use of these numbers will identify the product line and expedite your inquiries through a service network established to help you obtain product and tooling information. Such information can be obtained through a local representative or, after purchase, by calling PRODUCT INFORMATION at the number at the bottom of page 1.

2.3. Drawings

Customer Drawings for product part numbers are available from the service network. If there is a conflict between the information contained in the Customer Drawings and this specification or with any other technical documentation supplied, call PRODUCT INFORMATION at the number at the bottom of page 1.

2.4. Instructional Material

Instruction Sheets (408-series) provide assembly instructions and Customer Manuals (409-series) provide machine setup and operation procedures. Documents available which pertain to this product are:

- 408-4089 Ratcheted Cable Cutter Hand Tool 607453-2
- 408-4557 Heavy Duty Cable Cutter Hand Tool 605743-1
- 408-4559 Heavy Duty Cable Cutter Hand Tool 605744-1
- 408-4561 Heavy Duty Cable Cutter Hand Tool 600769-1
- 408-8059 General Preventive Maintenance for Miniature Quick-Change Applicators
- 408-8540 Crimp Tool 1526955-1
- 408-8636 Power Series 50 Connector Assemblies
- 408-9688 Cable Stripper/Slitter Tool 606700-1
- 408-9816 Handling of Reeled Products
- 409-1993 AMP-TAPETRONIC* Machine 69875

3. REQUIREMENTS

IMPORTANT: Using the exact products and application requirements described in this document will ensure proper application; however, to ensure reliability of performance, it is highly recommended that an independent evaluation be conducted of the chosen product combinations (wire, connector assemblies, and system) before final application is approved.

3.1. Special Assembly Considerations and Safety

These connectors **MUST NOT** be used for interrupting current; otherwise, there is risk of electrical shock. In any case, the electrical power supply must **ALWAYS BE DISCONNECTED**, and the connectors must **ALWAYS BE DE-ENERGIZED** (this might include disconnecting the cable from the battery) before mating and unmating or servicing the connectors.

It is highly recommended that these connectors not be used in external power applications where the electrical potential exceeds 42 V. In applications where these connectors are located internal to a device and do not serve as the primary means of connection, high voltages are allowable. It must be determined by the original equipment manufacturer (OEM) whether the connectors meet electrical and safety requirements when used in a specific application.



In applications where the connectors are used external to a device or as the primary means of disconnecting power supplies or charging equipment, care must be taken to avoid touching exposed electrical contacts as there is risk of electric shock.

3.2. Limitations

This product is designed to operate in a temperature range of -20° to 105°C [-4° to 221°F].

3.3. Material

The housing is made of polycarbonate, rated 94 V-0 by Underwriters Laboratories Inc. (UL). The springs (inside the housing) are made of stainless steel. The contacts and reducing bushing are made of copper plated with silver.

3.4. Storage

A. Ultraviolet Light

Prolonged exposure to ultraviolet light may deteriorate the chemical composition used in the housing material.

B. Shelf Life

The housings and contacts should remain in the shipping containers until ready for use to prevent deformation. The housings and contacts should be used on a first in, first out basis to avoid storage contamination that could adversely affect performance.

C. Chemical Exposure

Do not store housings or contacts near any chemical listed below as they may cause discoloration of the plated finish of the contacts or stress corrosion cracking in the housing or contact material.

Alkalies	Ammonia	Citrates	Phosphates	Citrates	Sulfur Compounds
Amines	Carbonates	Nitrites	Sulfur Nitrites		Tartrates

3.5. Wire Selection and Preparation

The contacts accept stranded (recommended a minimum of 19 strands) copper wire sizes 6 through 12 AWG with a maximum insulation diameter of 11.18 mm [.440 in.]. Contact size 6 can accept smaller wire sizes to a minimum of size 16 AWG with the use of the appropriate size reducing bushing (as described in Paragraph 3.6).



Wires with less than 19 strands may be too stiff and difficult to work with.

Tarnished copper wire must be thoroughly cleaned using a stiff wire brush, or other suitable method, that penetrates the entire bundle and cleans every conductor. The wire must be restored to a bright copper finish. The contact wire barrels are lined with silver plating to assure consistently high conductivity which will be reduced if tarnished wire is used.

The wire must be cut to length. Proper strip length is necessary to properly insert the conductors into the contact. The strip length of the wire is shown in Figure 2.



Reasonable care must be taken not to nick or scrape any part of the wire during the stripping.

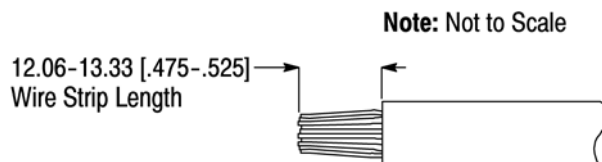
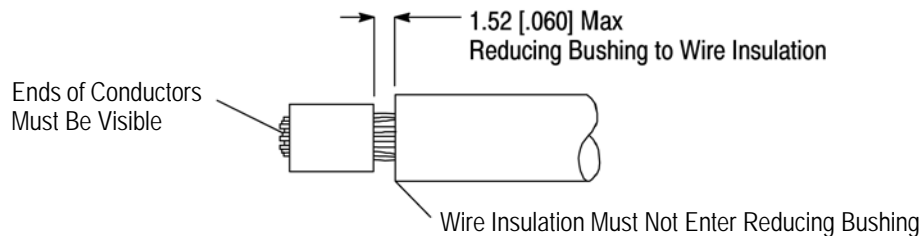

Figure 2

3.6. Reducing Bushing

Reducing bushings are available for contact size 6 to accommodate smaller wire sizes to a minimum of size 16 AWG. When required, the appropriate size reducing bushing must be installed onto the wire before inserting the wire into the contact (the reducing bushing can be installed onto the wire before or after stripping the wire). Placement of the reducing bushing must meet the requirements shown in Figure 3.

Placement of Reducing Bushing on Stripped Wire



Placement of Wire and Reducing Bushing in Contact

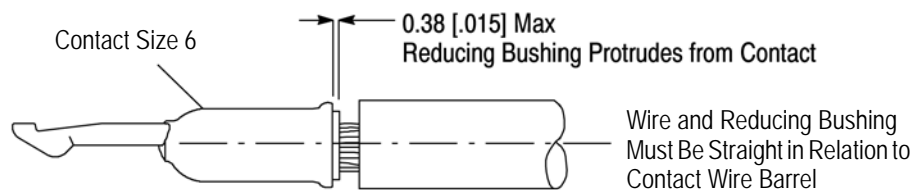

Figure 3

3.7. Crimp Requirements

A. Reducing Bushing

If a reducing bushing is used, the reducing bushing must be held firmly inside the contact wire barrel. The reducing bushing must be straight in relation to the wire barrel and can protrude from the wire barrel to the dimension provided in Figure 4.

B. Tab

The contact tab must not be deformed in any way. See Figure 4.

C. Wire Barrel Crimp

All conductors must be held firmly inside the wire barrel. The crimp applied to the contact wire barrel is the most compressed area and most critical in ensuring optimum performance of the crimped contact. The crimped area must be symmetrical on both sides of the wire barrel as shown in Figure 4.

NOTE

The developed crimp configurations result from using the specific tooling described in Section 5, TOOLING.



D. Wire Conductor and Insulation Location

No conductors can be folded back over the wire insulation. The insulation must not enter the wire barrel. The conductors must be visible between the reducing bushing, if applicable, or contact wire barrel and the wire insulation within the dimension stated in Figure 4.

Crimp Requirements

Note: Dual-indent crimp shown. Requirements apply equally to single-indent crimp.

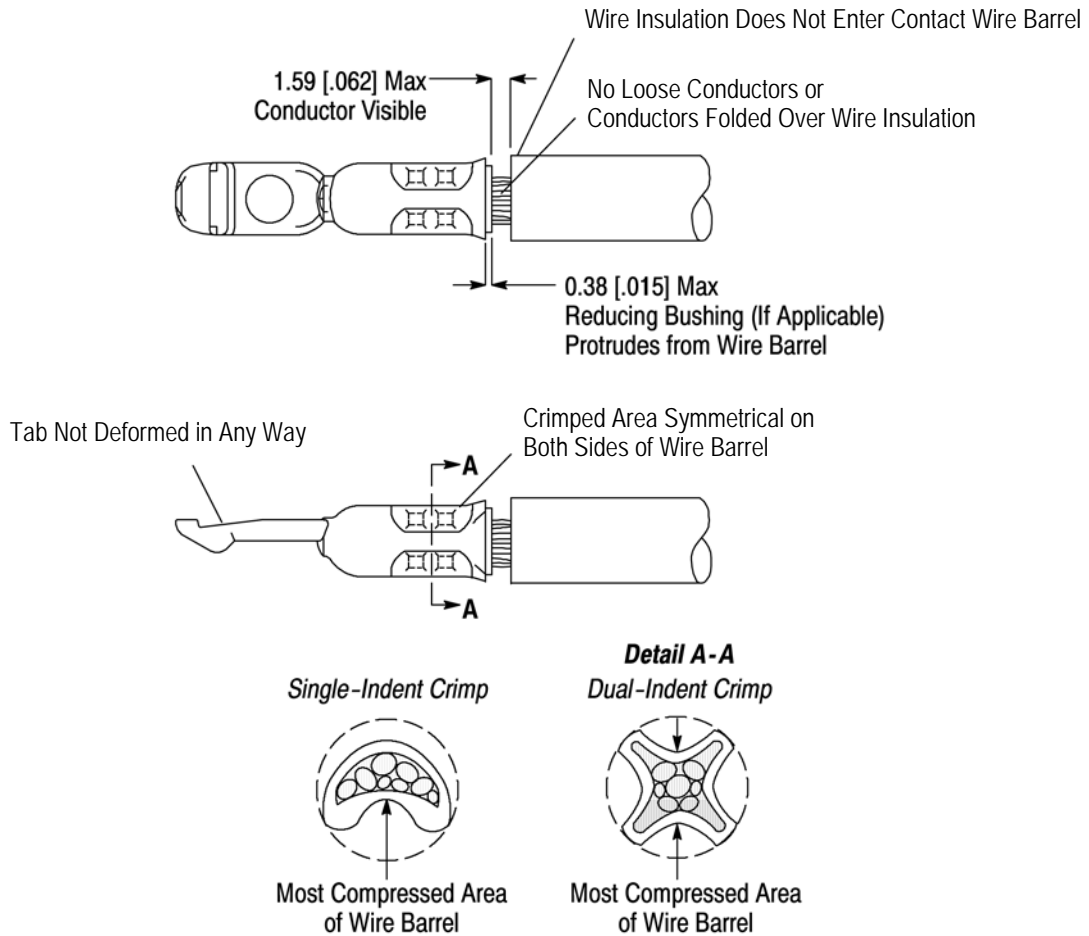

Figure 4

E. Twist and Roll

There should be no twist or roll of the wire barrel of the crimped contact that would cause overstress or impair usage. See Figure 5.

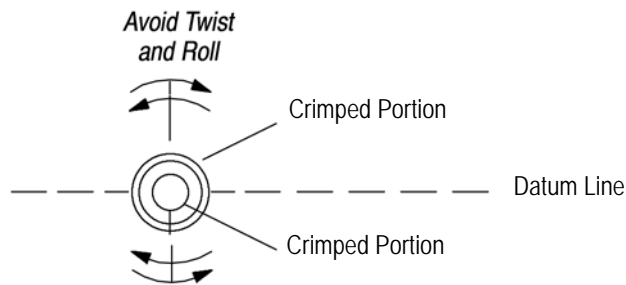

Figure 5

F. Bend Allowance

The force applied during crimping may cause some bending between the wire barrel and wire. Such deformation is acceptable within the following limits.

- 1) Up and Down -- The crimped portion must not be bent beyond the limits shown in Figure 6.
- 2) Side-to-Side -- The crimped portion must not be bent from one side to the other beyond the limits shown in Figure 6.

Note: Dual-indent crimp shown. Requirements apply equally to single-indent crimp.

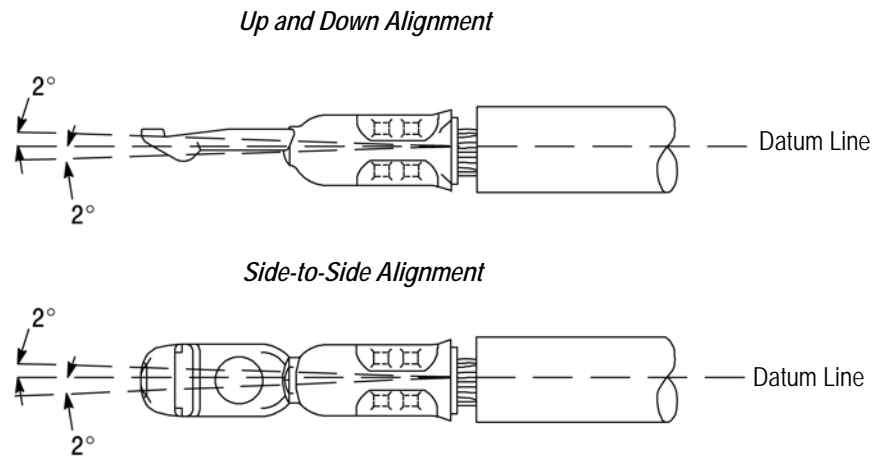

Figure 6

3.8. Keying

Assurance of proper mating is provided by a molded-in mechanical key at the mating face of the housing. The position of the key of the mating housings must be compatible. The customer drawing for the specific housing provides the key position.

NOTE *Other key positions are available upon request.*



3.9. Installing Contacts into Housing

DANGER *The electrical supply MUST BE DISCONNECTED and the connectors MUST BE DE-ENERGIZED (this might include disconnecting the cable from the battery) before installing the contacts into the housing.*



The contacts must NOT be forced into the housing. Each contact must be installed in the housing according to the following requirements.

1. Each contact must be inserted into the wire side of the housing.
2. The bottom of each contact must face the retention spring of the housing.
3. Each contact must be in straight alignment with the contact cavity.
4. Each contact must be fully latched onto the housing retaining spring.

3.10. Removing Contacts from Housing

The housing retention spring must be depressed away from the underside of the contact to remove the contact from the housing. A contact must be removed from the housing according to the following:



*The electrical supply **MUST BE DISCONNECTED** and the connectors **MUST BE DE-ENERGIZED** (this might include disconnecting the cable from the battery) before removing the contacts from the housing.*



Section 5 lists available extraction tools used to remove these contacts.

1. The tip of the tool must be inserted between the sides of contact and the contact cavity at the mating face of the housing.
2. The handle of the tool must be pushed down so that the housing retention spring is depressed away from the underside of the contact. While holding the tool in position, the wire must be pushed down and gently pulled back until the contact is free from the housing.

3.11. Mating and Unmating Connectors



*The electrical supply **MUST BE DISCONNECTED** and the connectors **MUST BE DE-ENERGIZED** (this might include disconnecting the cable from the battery) before mating or unmating the connectors.*

The connectors must NOT be forced to mate or unmate. When fully mated, the housings must appear flush at the point of engagement.

3.12. Repair

The contact, housing, and reducing bushing are not repairable. Damaged or defective contacts, housings, or reducing bushings must not be used. The contacts or reducing bushings must not be re-used by removing the wire.

4. QUALIFICATION

Power Series 50 connector assemblies are Component Recognized by Underwriters Laboratories Inc. (UL) in File E28476 and have been Investigated to CSA International Standards by UL.

5. TOOLING

Tooling part numbers and instructional material packaged with the tooling are shown in Figure 7.

5.1. Cable Cutters

These cable cutters are available for cutting the cable to length.

5.2. Hand Tools

Hand tools for manual application of loose piece contacts are available to cover the full wire size range.

Industry standard tooling for manual application of loose piece contacts is available for the full wire size range. Recommended manufacturer and tooling description and part numbers are given in Figure 7.

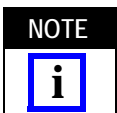

Consult manufacturer's literature for information on using the tooling.

5.3. Power Unit

A semi-automatic machine for power assisted application of tape and reeled contacts are available for the full wire size range. The machine is designed to be used as stand-alone bench unit.

5.4. Extraction Tool

The extraction tool or a standard insulated screwdriver with 1/4-in. flat blade must be used to remove contacts from the housing.

5.5. Stripping Tool

The cable stripper is used to strip insulation from the cable.

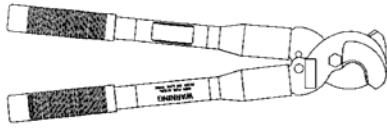

Heavy Duty Cable Cutter Hand Tool 600769-1
(408-4561)
Heavy Duty Cable Cutter Hand Tool 605743-1
(408-4557)
Heavy Duty Cable Cutter Hand Tool 605744-1
(408-4559)
Ratcheted Cable Cutter Hand Tool 607453-2
(408-4089)

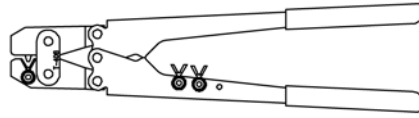

Crimp Tool 1526955-1
(408-8540)

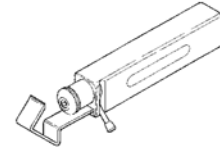

Cable Stripper/Slitter Tool 606700-1
(408-9688)

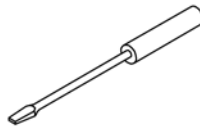

Standard Insulated Screwdriver
With 1/4-in. Flat Blade



Extraction Tool 68265-1
(No Document)

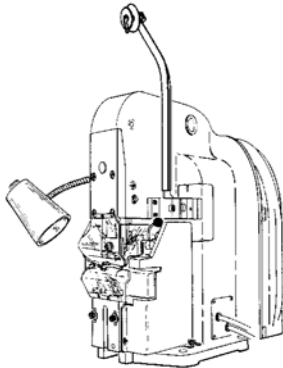

AMP-TAPETRONIC Machine 69875
(409-1993)

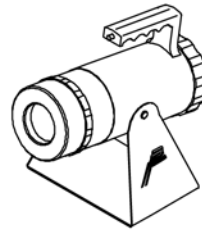

Commercially Available Pneumatic Hand
Crimping Tool, Die Set, and Locator (Dual-
Indent Crimp)

Available from Pacific Industrial Components
(PICO) Camarillo, CA (805) 388-5510
(<http://www.picotools.com>)
(See Table)

SERIES	DIE SET	LOCATOR	DIE CLOSURE FOR CONTACT SIZE	
			6 and 8	10-12
400	414DA-4583	4582-1	.152 in.	.134 in.
	414DA-4582			
500	514DA-7033	7033-1	.152 in.	.134 in.
	514DA-7034			

Figure 7

6. VISUAL AID

Figure 8 shows a typical application of Power Series 50 connector assemblies. This illustration should be used by production personnel to ensure a correctly applied product. Applications which DO NOT appear correct should be inspected using the information in the preceding pages of this specification and in the instructional material shipped with the product or tooling.

DUAL-INDENT CRIMP

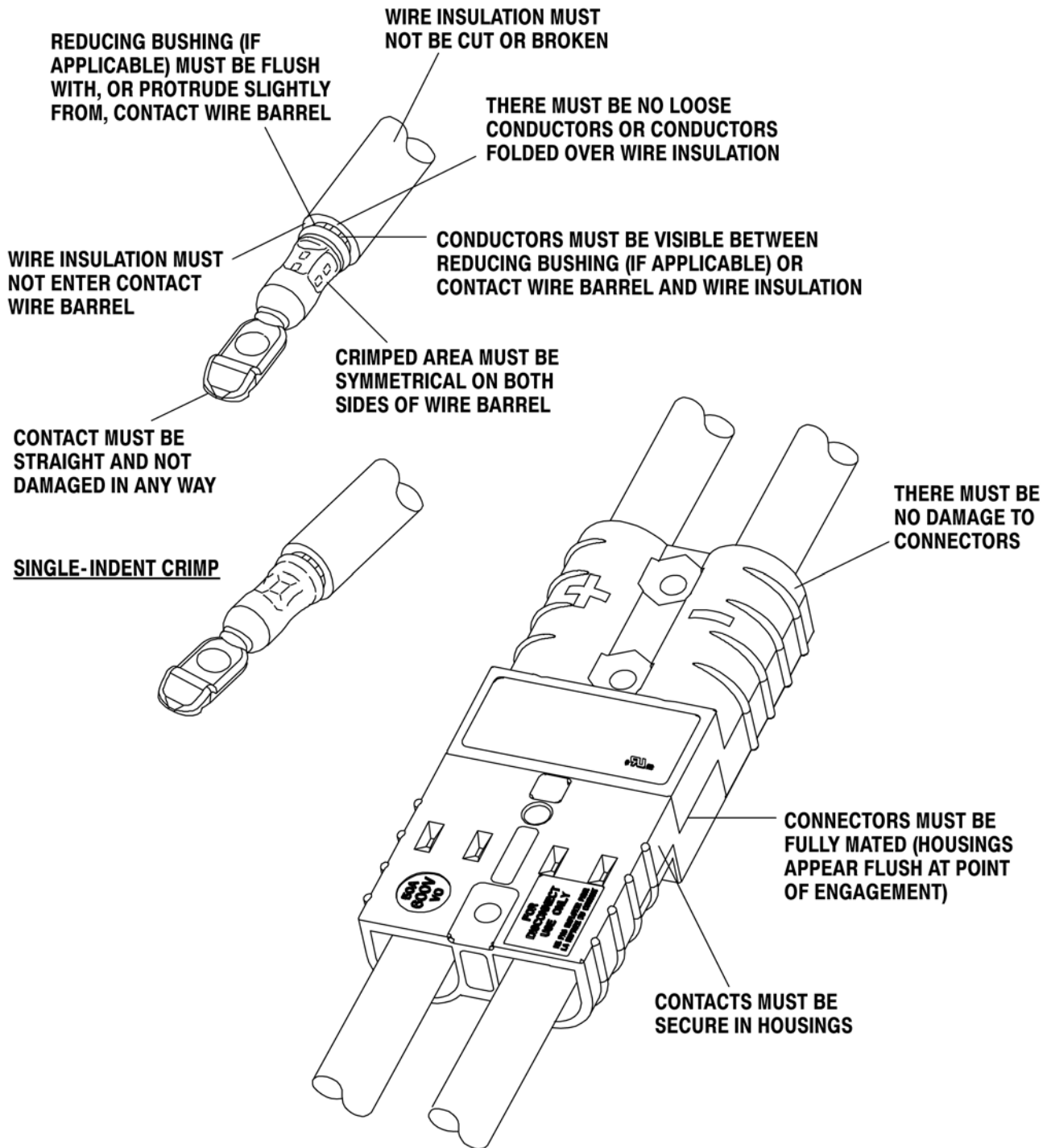

FIGURE 8. VISUAL AID