

MULTI-BEAM XL* Connectors
NOTE

All numerical values are in metric units [with U.S. customary units in brackets]. Dimensions are in millimeters [and inches]. Unless otherwise specified, dimensions have a tolerance of ± 0.13 [± 0.005] and angles have a tolerance of $\pm 2^\circ$. Figures and illustrations are for identification only and are not drawn to scale.

1. INTRODUCTION

This specification covers the requirements for application of MULTI-BEAM XL connectors onto printed circuit (pc) boards for use in power supplies. These connectors consist of vertical receptacle assemblies, right-angle receptacle assemblies, vertical header assemblies, and right-angle header assemblies. The connectors are available with either precision formed press-fit (compliant pin) contacts or solder type contacts. Each connector consists of a housing with power modules containing one power contact and signal modules containing 4 rows of signal contacts, either pin or socket. The signal pin contacts (only in header assemblies) are available in two contact mating lengths: standard and mate-last break-first (MLBF) (post mate), and the power contacts (only in receptacles) are available in two contact mating lengths: standard and mate-first break-last (MFBL) (pre-mate) for sequencing applications.

NOTE

The amount of power and signal contacts in a connector is customer specified. Any connector configuration can be designed to meet customer requirements—provided it is within the limitations stated in this document.

When corresponding with TE Connectivity Personnel, use the terminology provided in this specification to facilitate your inquiries for information. Basic terms and features of this product are provided in Figure 1.

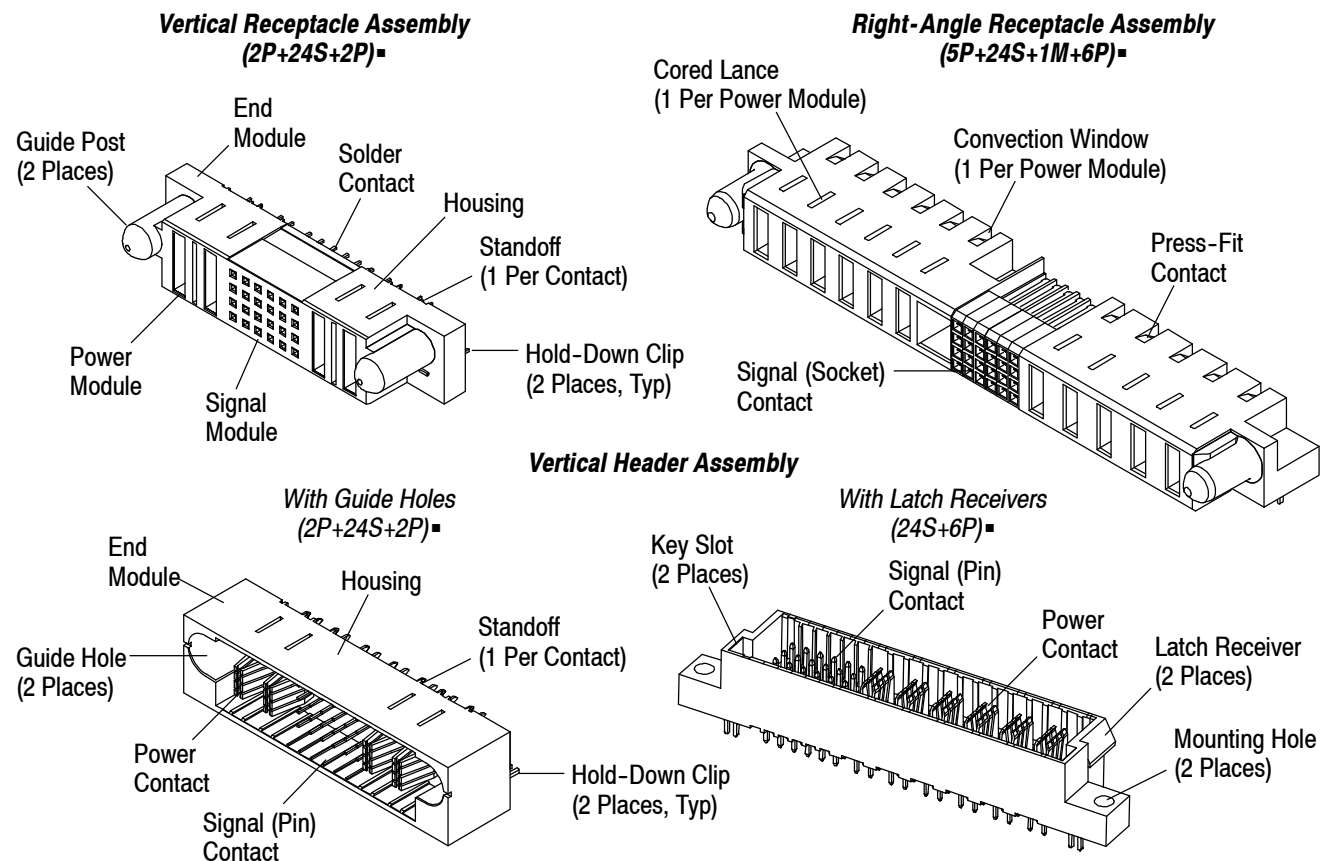

- 'P' stands for power module, 'S' stands for signal contacts, 'ACP' stands for power module with contact centerline spacing of 7.62 [.300], 'HDP' stands for high density power module with contact centerline spacing of 5.08 [.200], and 'M' stands for center module.

Figure 1 (Cont'd)

Right-Angle Header Assembly

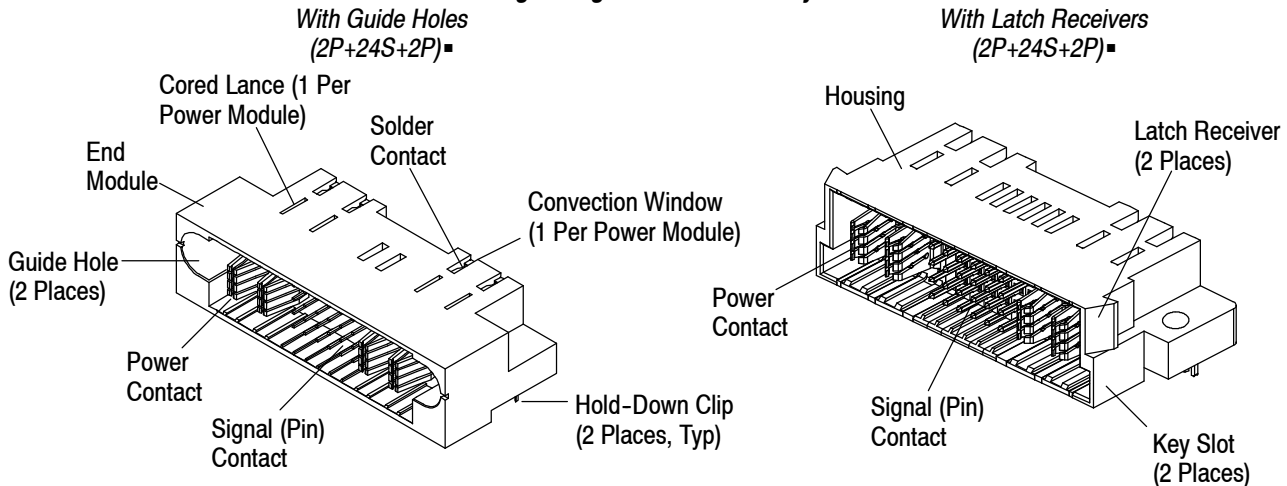

- 'P' stands for power module, 'S' stands for signal contacts, 'ACP' stands for power module with contact centerline spacing of 7.62 [.300], 'HDP' stands for high density power module with contact centerline spacing of 5.08 [.200], and 'M' stands for center module.

Figure 1 (End)

The maximum overall length allowed for the connector is 203 [8]. Combinations of up to 36 power contacts and 148 signal contacts can be used—provided the maximum allowable length is not exceeded.

Power modules are available with contact centerline spacing of 5.08 [.200], 6.35 [.250], 7.62 [.300], 9.53 [.375], and 10.8 [.425], and signal modules have a contact centerline spacing of 2.54 [.100]. End modules and center modules are available with features that provide blind mating, misalignment, and polarization.

End modules contain a guide post, guide hole, or latch receiver with key slot and a hold-down clip, and/or mounting hole, and center modules contain a hold-down clip or mounting hole. End modules without guides are also available. Guides (posts on receptacles and holes in headers) have rounded edges for ease of mating and are offset to prevent improper mating of connectors. The latch receiver with key slot ensures proper orientation of connectors when mating and that the connectors do not accidentally back-out. The hold-down clips help to align the connector to the pc board for installation then secure the connector for soldering. The mounting holes (which accept commercially-available standard screws) are also used to secure the connector to the pc board. The mounting holes are available with 3.10 [.122] or 3.81 [.150] diameter.

The connectors feature standoffs (one located at each contact) to facilitate pc board cleaning after soldering. Convection windows and cored lances located on the housing provide air flow for power modules.

The connectors are supplied in tray form for manual placement. These connectors mate with MULTI-BEAM XL cable receptacle assemblies (covered in Application Specification 114-13112) and MULTI-BEAM XL cable plug assemblies (covered in 114-13164).

2. REFERENCE MATERIAL

2.1. Revision Summary

Revisions to this application specification include:

- Updated document to corporate requirements and new logo
- Clarified hold-down clip hole dimension in Figure 4 and changed hole dimensions in Figure 8

2.2. Customer Assistance

Reference Product Part Number 6450120 and Product Code E655 are representative of MULTI-BEAM XL connectors. Use of these numbers will identify the product line and expedite your inquiries through a service network established to help you obtain product and tooling information. Such information can be obtained through a local Representative or, after purchase, by calling PRODUCT INFORMATION at the number at the bottom of page 1.

2.3. Drawings

Customer Drawings for product part numbers are available from the service network. If there is a conflict between the information contained in the Customer Drawings and this specification or with any other technical documentation supplied, call PRODUCT INFORMATION at the number at the bottom of page 1.

2.4. Manuals

Manual 402-40 can be used as a guide to soldering. This manual provides information on various flux types and characteristics with the commercial designation and flux removal procedures. A checklist is included in the manual as a guide for information on soldering problems.

2.5. Specifications

Product Specification 108-1973 provides product performance and test information.

Test Specification 109-11 provides solderability requirements and evaluation methods. Workmanship Specification 101-21 provides solder fillet requirements.

Application Specifications (114-series) provides product description and application requirements. Application specifications available which pertain to this product are:

- 114-13112 MULTI-BEAM XL Cable Receptacle Assemblies
- 114-13164 MULTI-BEAM XL Cable Plug Assemblies

2.6. Instructional Material

Instruction Sheets (408-series) provide assembly instructions and Customer Manuals (409-series) provide machine setup and operation procedures. Documents available which pertain to this product are:

- 408-8883 Seating Tool Assembly 1725769-[]

2.7. Standards

These connectors comply to Electronic Industries Alliance (EIA)-364, "Electrical Connector Test Procedures Including Environmental Classifications."

These connectors are compatible with Military Standard (MIL-STD)-2166, "Connectors, Electrical, Compliant Pin."

3. REQUIREMENTS

3.1. Safety

Do not stack product shipping containers so high that the containers buckle or deform.

3.2. Limitations

The connectors are designed to operate in a temperature range of -20° to 105°C [-4° to 221°F].

Voltage ratings for these connectors are based upon a circuit pad diameter of 1.60 ± 0.064 [$.063 \pm .0025$] and UL Material Group IIIb. This material group has a comparative tracking index (CTI) of $100 \leq \text{CTI} < 175$.

Voltage ratings according to contact centerline spacing and circuit pad travel are given in Figure 2.

3.3. Material

The housing is made of glass filled high temperature nylon, UL 94-V-0, with an oxygen index of 49%. The contacts are made of high-conductivity copper alloy underplated with nickel and plated with gold; solder tails are plated with tin over nickel. Hold-down clips are made of plated copper alloy.

3.4. Storage

A. Ultraviolet Light

Prolonged exposure to ultraviolet light may deteriorate the chemical composition used in the connector material.

MODULE		MAXIMUM VOLTAGE RATING IN AC (RMS) OR DC			
TYPE	CONTACT CENTERLINE SPACING	Within Primary Circuits	Primary to Secondary Circuits	Primary to Ground Circuits	Within Secondary Circuits
Signal	2.54 [.100]	—	—	—	60●
Power	5.08 [.200]	60●	60●	60●	60●
	6.35 [.250]	200	—	200	200
	7.62 [.300]	300	—	300	300
	9.53 [.375]	520	—	520	520
	10.8 [.425]	630	—	630	630

● Safety Extra Low Voltage (SELV) Circuits

Figure 2

B. Shelf Life

The connectors should remain in the shipping containers until ready for use to prevent deformation to the contacts. The connectors should be used on a first in, first out basis to avoid storage contamination that could adversely affect performance.

C. Chemical Exposure

Do not store connectors near any chemical listed below as they may cause stress corrosion cracking in the contacts.

Alkalies	Ammonia	Citrates	Phosphates	Citrates	Sulfur Compounds
Amines	Carbonates	Nitrites	Sulfur Nitrites		Tartrates

3.5. PC Board

A. Material and Thickness

The pc board material shall be glass epoxy (FR-4 or G-10). The pc board thickness shall be as stated in Figure 3.

PC BOARD THICKNESS		
CONNECTOR WITH PRESS-FIT CONTACTS	CONNECTOR WITH SOLDER TYPE CONTACTS	
	2.28±0.38 [.090±.015] Contact Tail Length	3.43±0.38 [.135±.015] Contact Tail Length
1.35 [.053] Min	1.40-1.75 [.055-.069]	2.11-2.62 [.083-.103]

Figure 3

B. Hole Dimensions and Durability

The contact holes must be drilled and plated through to specific dimensions to prevent stubbing during placement of the connector on the pc board and to ensure optimum continuity for circuits after soldering. If applicable, holes for the hold-down clips or mounting hardware may be used with or without plated through holes. The drilled hole size, plating types, plating thickness, and finished hole size must be as stated to provide unrestricted insertion. See Figure 4.

For connectors with press-fit contacts, the pc board holes cannot withstand connector removal more than three times. The radius of any board hole must not increase more than 0.038 [.0015] or decrease less than 0.0508 [.002].

C. Pads

The pc board circuit pads must be solderable in accordance with Test Specification 109-11.

D. Layout

The holes in the pc board must be precisely located to ensure proper placement and optimum performance of the connector. The pc board layout must be designed using the dimensions provided on the customer drawing for the specific connector. A *sample* of the recommended pc board layout is shown in Figure 5.

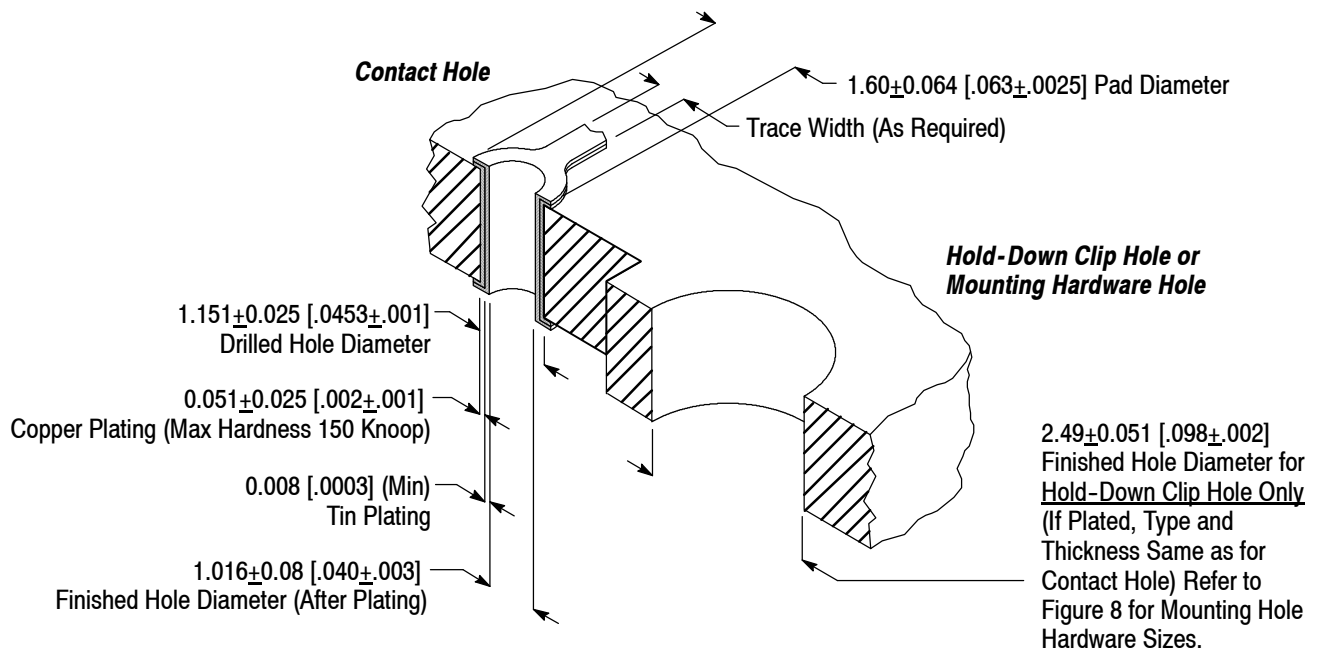
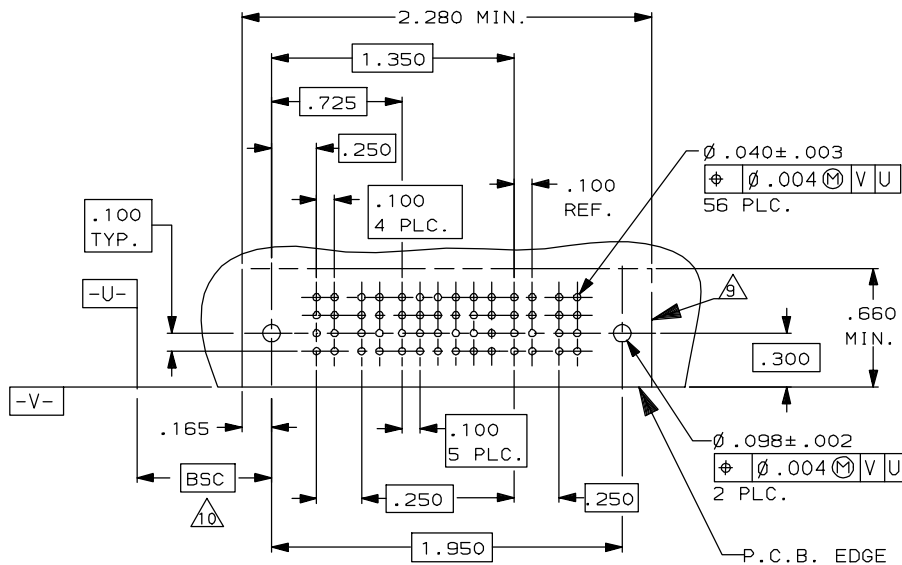

Figure 4

Sample Recommended PC Board Layout
Right-Angle Header With 2 Hold-Down Clips

PART NUMBER	ROWS	POWER		SIGNAL						POWER	
		P1	P2	1	2	3	4	5	6	P3	P4
1450120-2	D	PM	PM	J	J	J	J	J	J	PM	PM
	C			K	K	K	K	K	K		
	B			N	N	N	N	N	N		
	A			S	S	S	S	S	S		
		HD									HD
2P + 24S + 2P											



- ⚠ Mechanical Connector Keep Out Zone
- ⚠ Datum and Basic Dimensions Established by Customer

Figure 5

E. Spacing

Care must be used to avoid interference between adjacent connectors and other components. In addition, space allowed between pc boards for mating of connectors must be considered when determining distance between pc boards. The minimum allowable distance needed between connectors to ensure full mating of connectors and the allowable distance between pc boards with connectors fully mated is provided in Figure 6.

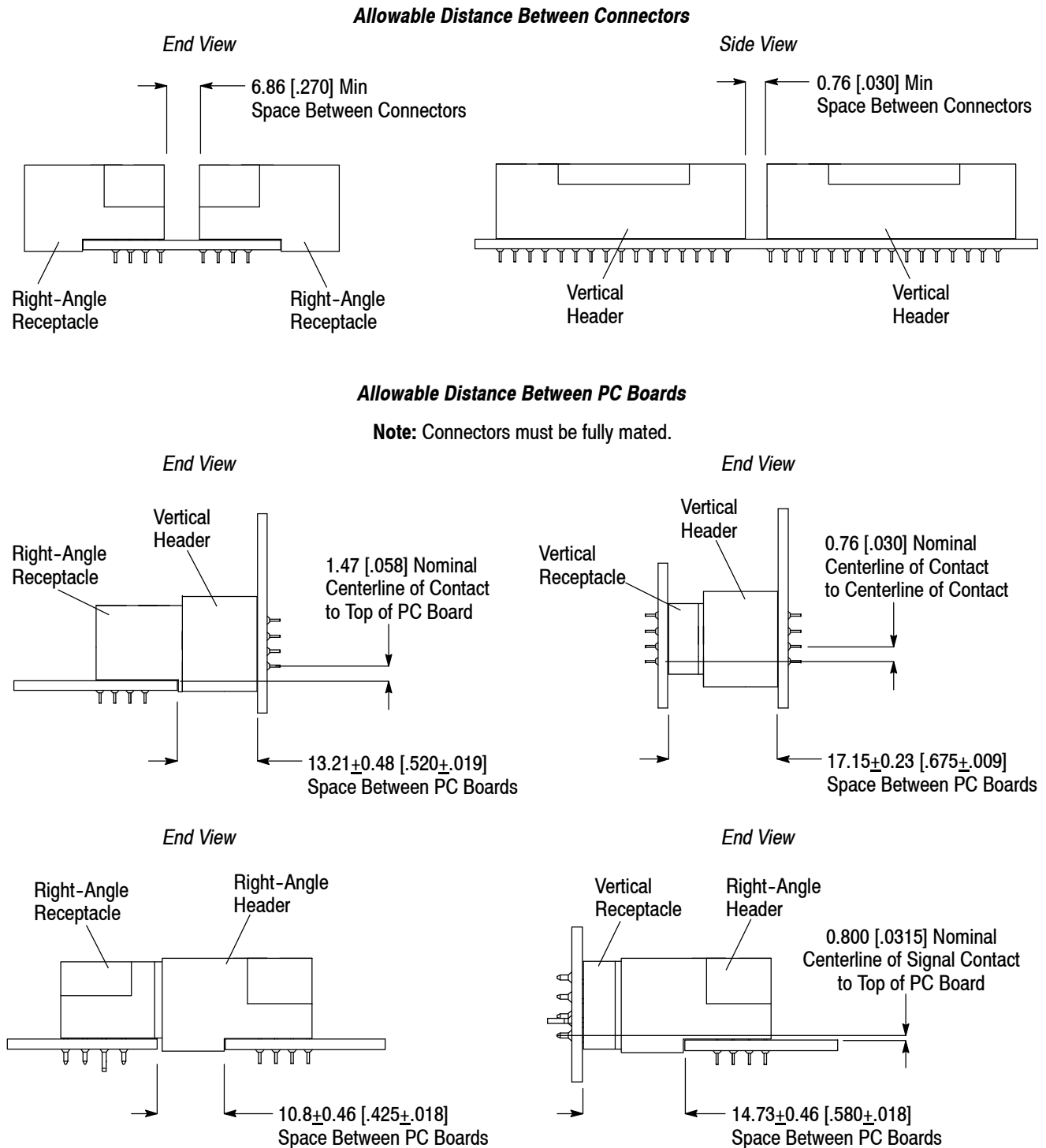

Figure 6

3.6. Connector Placement



Connectors should be handled only by the housing to avoid deformation, contamination, or damage to the contacts.

A. Registration

When placing connectors on the pc board, contacts and, if applicable, hold-down clips or mounting screws must be aligned and started into the matching holes before seating the connector onto the board.

B. Insertion Force

The force required to seat the connector with press-fit contacts or hold-down clips onto the pc board can be calculated by:

$$\text{Number of connector press-fit contacts} \times \text{maximum insertion force per contact N [lb]} = \text{insertion force N [lb]}$$

$$\text{Number of connector hold-down clips} \times \text{maximum insertion force per hold-down clip N [lb]} = \text{insertion force N [lb]}$$

The maximum amount of insertion force per press-fit contact and hold-down clip is given in Figure 7.

MAXIMUM INSERTION FORCE (N [lb])			
PER PRESS-FIT POWER CONTACT	PER PRESS-FIT SIGNAL CONTACT		PER HOLD-DOWN CLIP
890 [200]	Receptacles and Right-Angle Header	111 [25]	27 [6]
	Vertical Header	178 [40]	

Figure 7

3.7. Mounting Hardware

Connectors with mounting holes can be secured to the pc board before soldering using commercially-available standard screws. The screw size and maximum torque (applied to the mating face of the connector) is provided in Figure 8.

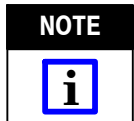

Typically, this method of mounting (or hold-down) serves connectors with solder type contacts and without hold-down clips.

MOUNTING HOLE DIAMETER	SCREW		MAXIMUM TORQUE Nm [in.-lb] (Applied to Mating Face)
	SIZE	HEAD DIAMETER (Maximum)	
3.30 [.130]	No. 4	7.37 [.290]	0.57 [5]
4.01 [.158]	No. 6	7.37 [.290]	0.23 [2]

Figure 8

3.8. Soldering

Observe guidelines and procedures when soldering contacts. Contact solder tails must be soldered, cleaned, and dried according to the following:

A. Flux Selection

Contact solder tails must be fluxed prior to soldering with a mildly active, rosin base flux. Selection of the flux will depend on the type of pc board and other components mounted on the board. Additionally, the flux must be compatible with the wave solder line, manufacturing, health, and safety requirements. Flux that is compatible with these connectors are provided in Figure 9.

FLUX TYPE	ACTIVITY	RESIDUE	COMMERCIAL DESIGNATION	
			KESTER	ALPHA
RMA	Mild	Noncorrosive	186	611

Figure 9

B. Process

The connectors can be soldered using wave soldering or equivalent soldering techniques. It is recommended using tin or tin-lead solder for these connectors. Refer to Manual 402-40 for soldering guidelines. The temperatures and exposure time shall be as specified in Figure 10.

SOLDERING PROCESS	WAVE TEMPERATURE	TIME (At Maximum Temperature)
Wave	265°C [509°F]	10 Seconds

Figure 10

C. Cleaning

After soldering, removal of fluxes, residues, and activators is necessary. Consult with the supplier of the solder and flux for recommended cleaning solvents. Cleaners must be free of dissolved flux and other contaminants. Common cleaning solvents that will not affect connectors for the time and temperature specified are listed in Figure 11.



Consideration must be given to toxicity and other safety requirements recommended by the solvent manufacturer. Refer to the manufacturer's Material Safety Data Sheet (MSDS) for characteristics and handling of cleaners. Trichloroethylene and Methylene Chloride is not recommended because of harmful occupational and environmental effects. Both are carcinogenic (cancer-causing).



Even when using "no clean" solder paste, it is imperative that the contact interface be kept clean of flux and residue, since it acts as an insulator. Flux may migrate under certain conditions with elevated temperatures and therefore, cleaning is necessary.

CLEANER		TIME (Minutes)	TEMPERATURE (Maximum)
NAME	TYPE		
BIOACT EC-7	Solvent	5	100°C [212°F]
BIOACT EC-7	Solvent	5	100°C [212°F]
Butyl CARBITOL	Solvent	1	Ambient Room
Isopropyl Alcohol	Solvent	5	100°C [212°F]
KESTER 5778	Aqueous	5	100°C [212°F]
KESTER 5779	Aqueous	5	100°C [212°F]
LONCOTERGE 520	Aqueous	5	100°C [212°F]
LONCOTERGE 530	Aqueous	5	100°C [212°F]
Terpene Solvent	Solvent	5	100°C [212°F]

Figure 11

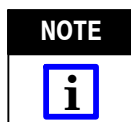

If you have a particular solvent that is not listed, contact PRODUCT INFORMATION at the number at the bottom of page 1.

ALPHA, BIOACT, CARBITOL, KESTER, and LONCOTERGE are trademarks of their respective owners.

D. Drying

When drying cleaned connectors and pc boards, make certain that temperature limitations are not exceeded: -55° to 105°C [-68° to 221°F]. Excessive temperatures may cause housing degradation.

3.9. Checking Installed Connector

A. With Press-Fit Contacts

The entire “eye” of each press-fit contact must be within the pc board hole. All standoffs must be seated on the pc board within the dimension provided in Figure 12, Detail A.

B. With Solder Type Contacts

All solder joints should conform to those specified in Workmanship Specification 101-21 and all other requirements specified in this document. Solder fillets must be evenly formed around each contact solder tail. There must be no visible skips or voids. All standoffs must be seated on the pc board within the dimension provided in Figure 12, Detail B.

Checking Installed Connector

Note: Requirements apply equally to all connectors.

Vertical Header With Press-Fit Contacts

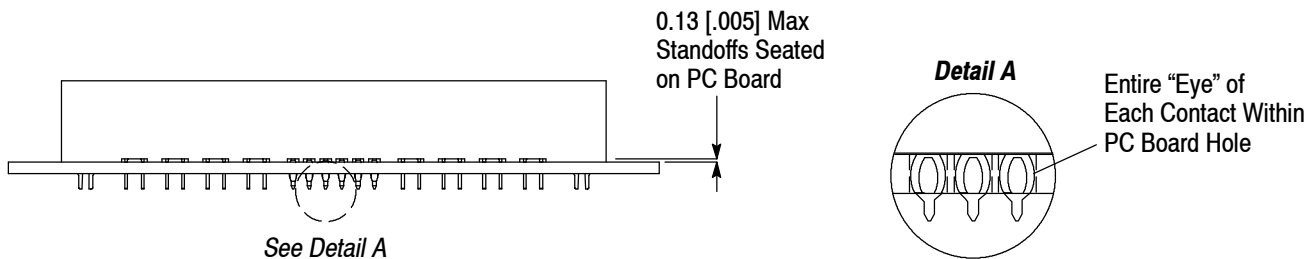

Vertical Receptacle With Solder Type Contacts

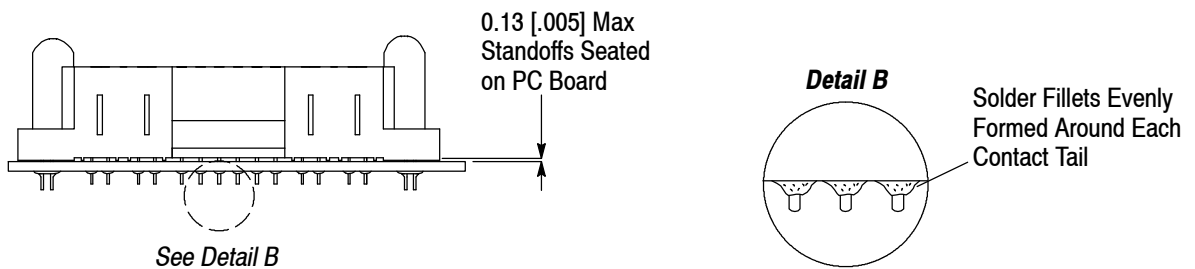

Figure 12

3.10. Connector Mating



Connectors should be handled only by the housing to avoid deformation, contamination, or damage to the contacts.

A. Polarization

For connectors with guides, polarization is provided by matching the guides of mating connectors. For connectors with latch receivers or without guides, polarization is provided by matching the mating alignment keys with the key slots of mating connectors.

B. Mating Force

The maximum amount of mating force per contact is given in Figure 13.

CONTACT	MAXIMUM MATING FORCE PER CONTACT (N [oz])
Power	9 [32]
Signal	1 [3.5]

Figure 13

C. Mating Length

Contact mating lengths available for the connectors are listed in Figure 14.

CONNECTOR	CONTACT MATING LENGTH	
	Power Contact	Signal Contact
Receptacle	Standard and MFBL (Pre-Mate)	Standard
Header	Standard	Standard and MLBF (Post Mate)

Figure 14

D. Wipe Length

Wipe length for these connectors is defined as that portion (length) of the mating contacts that touches (wipes) from the point of engagement to the point of being fully mated. The wipe length depends on the contact (power or signal) and mating length (standard, MFBL, or MLBF) of each *individual* contact. The minimum wipe length at the level of mating for power and signal contacts is listed in Figure 15.

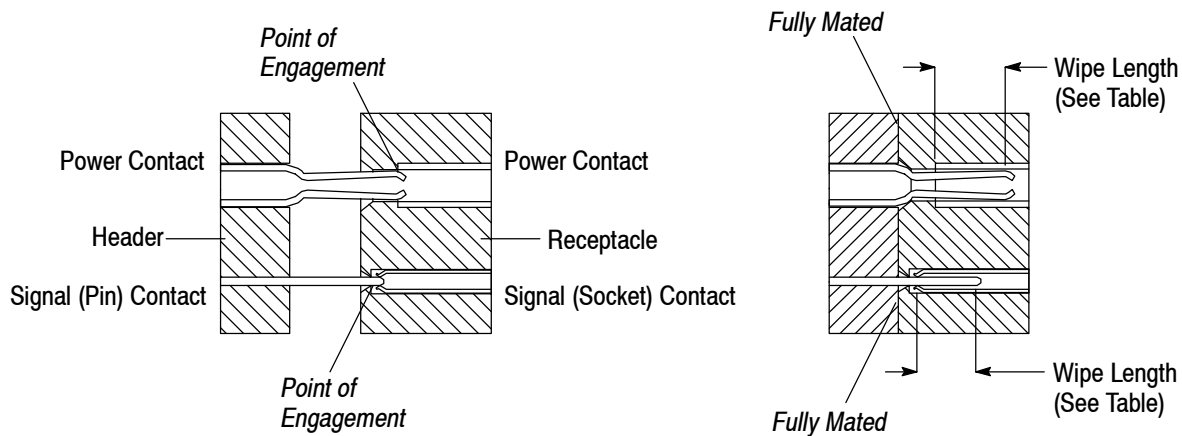

CONTACT	MATING LENGTH	MATING LEVEL	WIPE LENGTH (Min)
Power	MFBL (Pre-Mate)	1	5.08 [.200]
	Standard	2	3.81 [.150]
Signal	Standard	2	3.81 [.150]
	MLBF (Post Mate)	3	2.54 [.100]

Figure 15

E. Sequencing

The connectors provide sequencing among contacts with 3 mating levels. The offset distance, measured from the receptacle mating face to the header mating face at the point of electrical engagement, depends on the contact (power or signal) and mating length (standard, MFBL, or MLBF) of the mating connectors. The offset distance at the level of mating for power and signal contacts is listed in Figure 16.

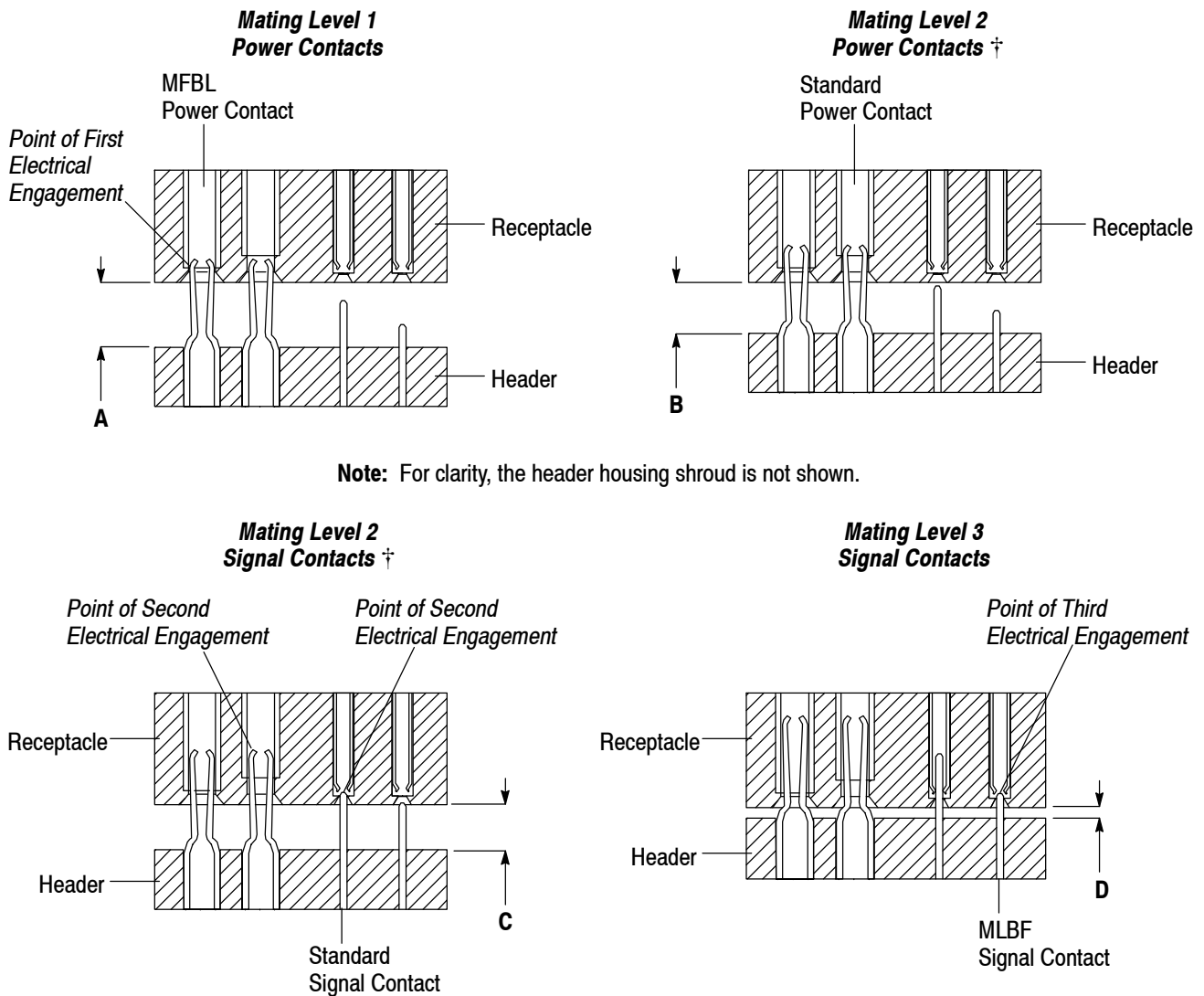

† The offset distance between Mating Level 2 for power contacts and Mating Level 2 for signal contacts is not enough to consider these as separate levels.

CONTACT	MATING LENGTH	MATING LEVEL	OFFSET DISTANCE	
			Dimension	Nominal
Power	MFBL (Pre-Mate)	1	A	6.15 [.242]
	Standard	2	B	5.18 [.204]
Signal	Standard	2	C	4.72 [.186]
	MLBF (Post Mate)	3	D	3.45 [.136]

Figure 16

F. Misalignment

When mating connectors, side-to-side and up-and-down misalignment is allowed to the dimensions given in Figure 17. There is no misalignment for connectors with latch receivers.

NOTE



Connectors with guides should be used in applications requiring blind mating. Connectors with latch receivers and connectors without guides should not be used in applications requiring blind mating.

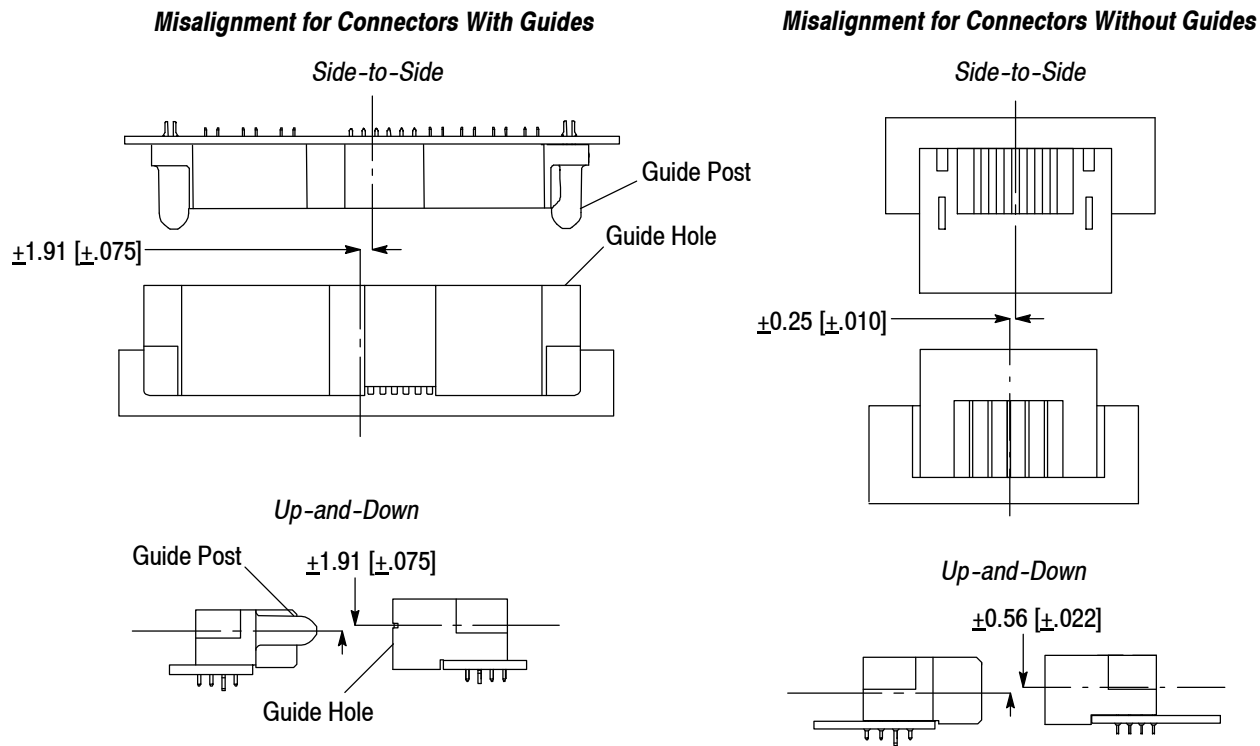
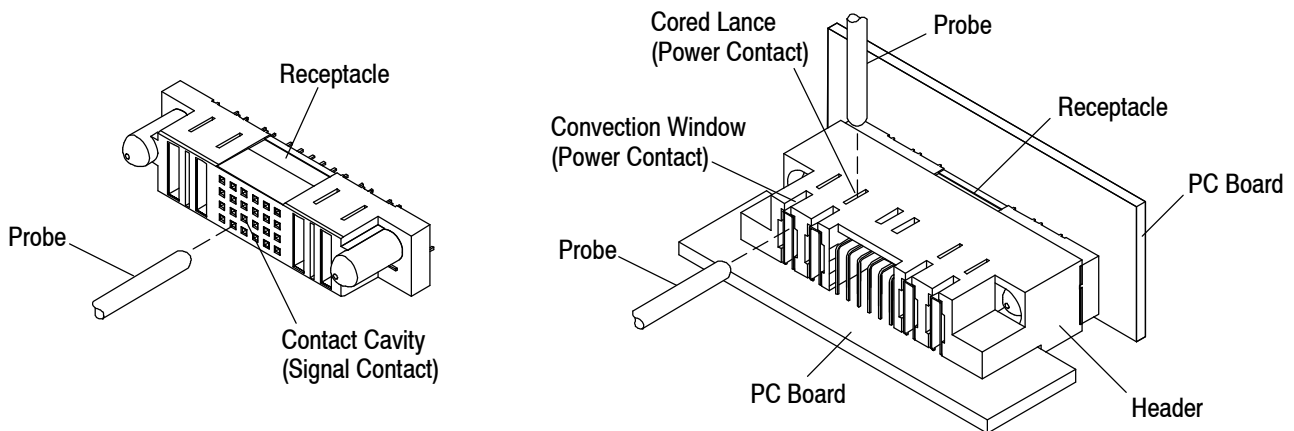

Figure 17

3.11. Circuit Testing

Unmated receptacles and mated headers must be tested against hazardous voltages using the test probe specified in UL 1950. Specific areas of the connector must be tested as indicated in Figure 18.



CONNECTOR	AREA TO BE TESTED		
	Unmated Receptacle	Mated Header	
	Contact Cavities	Convection Windows	Cored Lances
Vertical Receptacle	✓	✓	✓
Right-Angle Receptacle	✓	✓	✓
Vertical Header	—	✓	✓
Right-Angle Header	—	—	✓

Figure 18

3.12. Connector Unmating

The minimum amount of unmating force per contact is given in Figure 19.

CONTACT	MINIMUM UNMATING FORCE PER CONTACT (N [oz])
Power	2.22 [8]
Signal	.0973 [.35]

Figure 19

3.13. Connector Removal

A. Solder Type Contacts

Connectors with solder type contacts must be removed from the pc board by standard de-soldering methods. After removal from the board, the connector **MUST NOT** be re-used.

B. Press-Fit Contacts

Connectors with press-fit contacts must be removed from the pc board using a push bar (or flat rock) and pc board support.



*For reparability, the tips of the contacts must extend below the surface of the pc board by at least 1.02 [.040]; if not, the connector **MUST NOT** be removed from the pc board.*

C. Retention Force

The force retaining the connector with press-fit contacts or hold-down clips on the pc board can be calculated by:

$$\text{Number of connector press-fit contacts} \times \text{minimum retention force per contact N [lb]} = \text{retention force N [lb]}$$

$$\text{Number of connector hold-down clips} \times \text{minimum retention force per hold-down clip N [lb]} = \text{retention force N [lb]}$$

The minimum amount of retention force per press-fit contact and hold-down clip is given in Figure 20.

MINIMUM RETENTION FORCE (N [lb])		
PER PRESS-FIT POWER CONTACT	PER PRESS-FIT SIGNAL CONTACT	PER HOLD-DOWN CLIP
178 [40]	6.7 [1.5]	13.3 [3]

Figure 20

3.14. Repair

These connectors are not repairable. Damaged or defective connectors must not be used.

4. QUALIFICATION

MULTI-BEAM XL connectors are Recognized by UL in File E28476 and Certified by CSA International in Certificate 1191639 (File 164196).

5. TOOLING

5.1. Connectors with Solder Type Contacts

No tooling is required for placement of the connectors with solder type contacts onto the pc board.

5.2. Vertical Headers with Press-Fit Contacts

Tooling for seating vertical headers having press-fit contacts is available. A pc board support and application tooling (such as an arbor press) that provides sufficient amount of downward force to insert the contacts into the pc board holes must be used with the seating tool. Part numbers and instructional material packaged with the seating tooling are given in Figure 21.

5.3. Receptacles and Right-Angle Headers with Press-Fit Contacts

A. Application Tooling

The application tooling (such as an arbor press) used to seat these connectors must provide sufficient amount of downward force to insert the contacts into the pc board holes.

B. PC Board Support

A pc board support must be used to prevent bowing of the pc board during the placement of these connectors on the board. The board support must have a flat surface with holes or a channel large enough and deep enough to receive any protruding components. The pc board must be secured to the board support to prevent movement of the board during seating. Refer to Figure 21.

The board support must also be used when removing these connectors from the pc board.

C. Flat Rock Tooling

Commercially available bar stock (flat rock tooling) with a flat surface large enough to cover all contacts must be used with the application tooling to seat these connectors. For vertical receptacles with guides, the flat rock tooling must be sized to fit between the guides.

For removing these connectors from the pc board, it is suggested that the pc board be supported from the connector side and that the connector be removed using flat rock tooling.

Seating Receptacles and Right-Angle Headers With Press-Fit Contacts

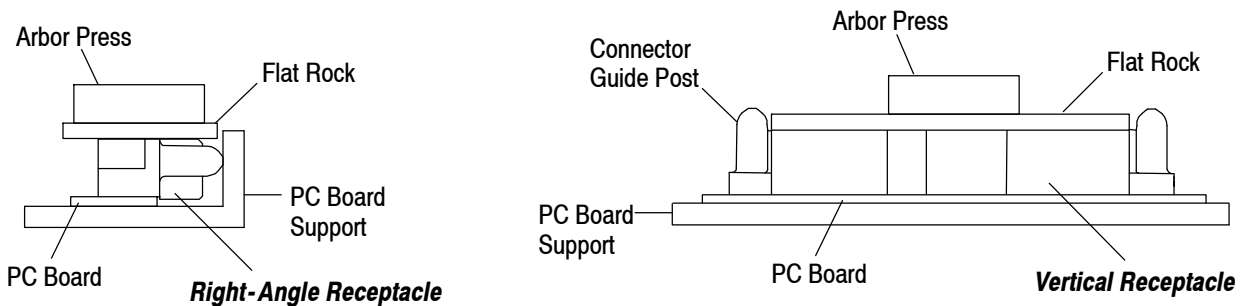

Seating Vertical Headers Having ONLY Press-Fit Power Contacts

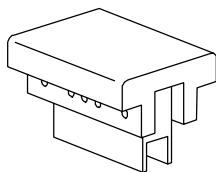

Seating Tool Assemblies
1725769-[] (408-8883)

Seating Vertical Headers Having Press-Fit Power AND Signal Contacts

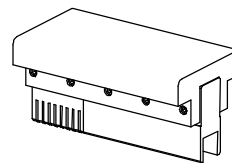

Seating Tool Assemblies 1804872-[],
1901220-[], and 1901221-1 (408-10047)

Figure 21

6. VISUAL AID

The illustration below shows a typical application of MULTI-BEAM XL connectors. This illustration should be used by production personnel to ensure a correctly applied product. Applications which DO NOT appear correct should be inspected using the information in the preceding pages of this specification and in the instructional material shipped with the product or tooling.

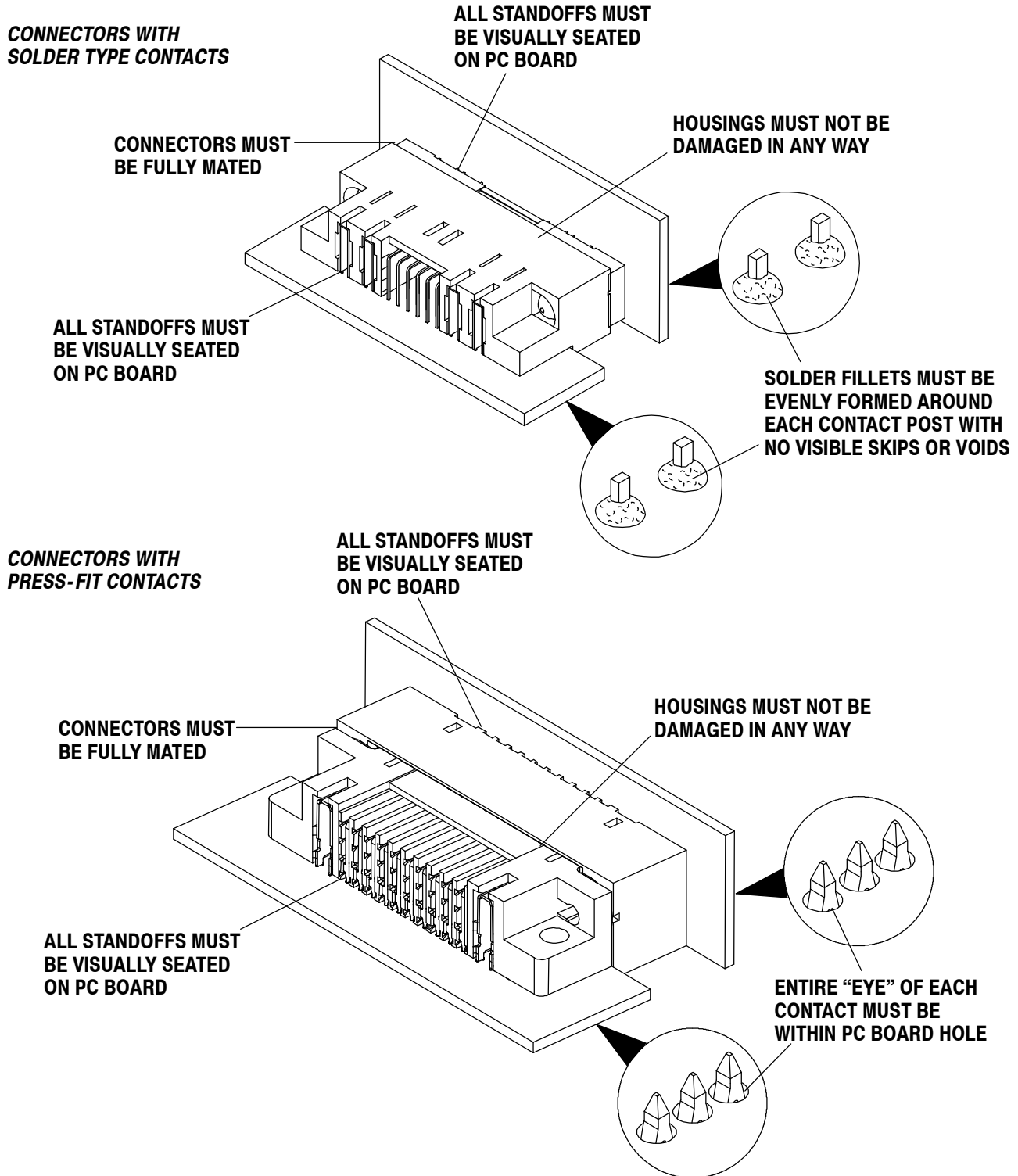

FIGURE 22. VISUAL AID