

1.Scope:

This specification covers product performance requirement and test methods for Steering Column Combination Switch(SCCS) Connector of the following part numbers.

2.Product Part Numbers and Nomenclatures:**2.1 Contact:****2.2.1 Receptacle Contact:**

SCCS MK-I	SCCS MK-II
173630: (For 0.3mm ² marked "S")	175268: (For 0.3-0.85mm ² marked "S")
173631: (For 0.5-1.25mm ² marked "M")	175269: (For 0.5-1.25mm ² marked "M")
173632: (For 1.25-2mm ² marked "L")	175270: (For 1.25-2mm ² marked "L")

2.1.2 Tab Contact:

SCCS MK-I	SCCS MK-II
173633: (For 0.3mm ² marked "S")	175272: (For 0.3-0.85mm ² marked "S")
173645: (For 0.5-1.25mm ² marked "M")	175273: (For 0.5-1.25mm ² marked "M")
173634: (For 1.25-2mm ² marked "L")	175274: (For 1.25-2mm ² marked "L")

2.2 Housing:

SCCS MK-I	SCCS MK-II
172900: 34Positions Cap Housing	177511: 34Positions Cap Housing
172901: 20Position Plug Housing	175371: 20Position Plug Housing
172902: 14position Plug Housing	175368: 14position Plug Housing

3.Definition of Terms:

For the purpose of this specification, the following terms shall apply.

3.1 Contact:

A contact is an electrically conductive metallic component member to make circuit termination, being encapsulated in housing. Tab contact and receptacle contact are available.

3.2 Housing:

A housing is an electrically insulating plastic component member that encapsulates contacts. Plug housing that encapsulates receptacle contacts and cap housing that encapsulates tab contacts, are available.

3.3 Connector:

A connector is an assembly of housing and contacts loaded in all contact positions. Plug connector assembly that contains receptacle contacts, and cap connector assembly that contains tab contacts, are available.

4. Material and Finish:

4.1 Contact:

Contacts are made of pre-tinned brass conforming to Copper Alloy 260 of ASTM B 36.

4.2 Housing:

Housing is made of PBT resin.

5. Product Design Feature, Construction and Dimensions:

5.1 Contact:

Product design feature, construction and dimensions of contact shall be conforming to the applicable customer product drawing(s). All the contacts shall be interrelation mated regardless of the difference of the wire sizes applied for termination.

5.2 Housing:

Product design feature, construction and dimension of housing shall be conforming to the applicable customer product drawing(s). Housing shall be provided with polarizing key that prevent housings from mismatching, and locking device that ensures engagement of connector halves.

6. Rating:

6.1 Temperature Rating:

Temperature rating shall be within the range of -30°C and +105°C including ambient temperature and temperature rising resulted from loaded current.

6.2 Applicable Wire Sizes:

For the termination of the products used for product performance evaluation testing, the wires of the following sizes shall be used.

SCCS MK-I		
Part Number	Applicable Wire Range	Insulation Diameter(mm)
173630 173633	0.3mm ² (#22AWG) one wire	1.4-1.9mm
173631 173645	0.5-1.25mm ² (#20-#16AWG) one wire	2.0-2.6mm
173632 173634	1.25-2mm ² (#16-#14AWG) one wire	2.6-3.1mm

SCCS MK-II		
Part Number	Applicable Wire Range	Insulation Diameter(mm)
175272 175268	0.3-0.85mm ² (#22-#18AWG) one wire	1.1-1.9mm
175273 175269	0.5-1.25mm ² (#20-#16AWG) one wire	1.8-2.6mm
175274 175270	1.25-2mm ² (#16-#14AWG) one wire	2.5-2.9mm

7.Product Performance Requirements and Test Methods:

7.1 Product Performance Requirements:

When tested in accordance with the test methods specified in Para. 7.2, and test sequence specified in Para. 7.3, the performance requirements specified in Table.1 shall be met.

Table 1

Test Item (Paragraph Number)	Contact Performance	Connector Performance	
	Initial	Initial	After Environmental Conditioning(Final)
Appearance: (Para. 7.2.1)	Visually and tactually inspect if cracks, breakage, damages, slacking and loose of parts, rust fusion and deformation that are detrimental to connector functions, are present.		
Contact or Connector Insertion Force (Para. 7.2.2)	2.94-7.84N	14 Position 117.6N max. 20 Position 147N max.	
Contact or Connector Extraction Force (Para. 7.2.3)	2.94-7.84N	14 Position 14.7-117.6N 20 Position 19.6-147N	
Termination Resistance (Low Level) (Para. 7.2.4)	3.0mΩ max.	3.0mΩ max.	10mΩ max.
Termination Resistance (Para. 7.2.5)	3.0mV/A max.	3.0mV/A max.	10mV/A max.
Physical Touch/Feeling at Insertion/Extraction Handling (Para. 7.2.6)	No conflict or difficulties that are detrimental to insertion/extraction assembly operation, shall be perceived.		
Insulation Resistance (Para. 7.2.7)	—	100MΩ min.	
Dielectric Strength (Para. 7.2.8)		No abnormalities shall be evident after applying test potential of 1,800V AC for 1 minute.	
Current Leakage (Para. 7.2.9)		3mA max.	
Contact Retention Force (Para. 7.2.10)		Only Lance - 58.8N min. Total(Lance + Double lock) -78.4N min.	

Crimp Tensile Strength (Para. 7.2.11)	Wire size mm ² (AWG)	Crimp(N) Tensile Strength (min.)	—
	0.3	58.8	
	0.5	88.2	
	0.85	127.4	
	1.25	176.4	
2.0	264.6		
Housing Retention Force (Para. 7.2.12)	—		98N min.
Current Cycling (Para. 7.2.13)	—		When tested Environment Resistivity in accordance with the test sequence specified in Table 5, performance shall meet the requirements.
Temperature Rising (Para. 7.2.14)			
Repeated Insertion/Extraction (Para. 7.2.15)			
"Kojiri" Resistivity (Para. 7.2.16)			
Heat Resistivity (Para. 7.2.17)			
Cold Resistivity (Para. 7.2.18)			
Thermal Shock (Para. 7.2.19)			
Humidity(Steady State) (Para. 7.2.20)			
Salt Spray (Para. 7.2.21)			
Dust and Sand Bombardment (Para. 7.2.22)			
Vibration, High Frequency (Para. 7.2.23)			
Current Overload (Para. 7.2.24)	—		Sample shall not start inflammation.
Contact Loading Force (Para. 7.2.25)	—	14.7N max.	—

7.2 Test Methods:**7.2.1 Appearance:**

Visually and tactually inspect if detrimental abnormalities such as cracks, breakage, damages, slacking and loose of parts, rust, fusion and deformation are evident.

7.2.2 Contact or Connector Insertion Force:

Securely fasten one of the mating pair of contacts or connectors on the tensile testing machine, and apply an axial push in force to the counterpart contact or connector to mate with by operating the head to travel with the speed at a rate of 100mm a minute uniformly. For this test, locking device is set in effect.

7.2.3 Contact or Connector Extraction Force:

Securely fasten one of the mated pair of contacts or connectors on the tensile testing machine, and apply an axial pull off load to the counterpart contact or connector to unmate from by operating the head to travel with the speed at a rate of 100mm a minute uniformly. For this test, locking device is not set in effect.

7.2.4 Termination Resistance(Low Level) :

Apply test current of 50mA maximum at open circuit voltage of 50mV maximum DC to the contacts or connectors in the mated condition, and measure by probing at the points 75mm apart from the wire crimp(across Y-Y' in Fig. 1). Termination resistance is obtained by calculation after deducting the resistance of the 150mm long wire used for termination. The measurement shall be done by probing the positions one by one respectively.

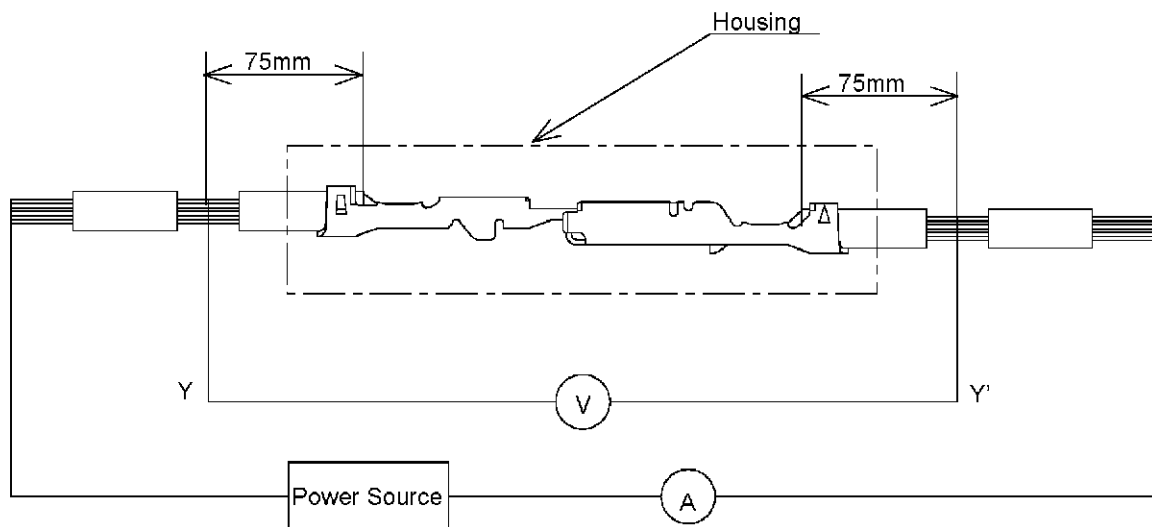
**Fig.1**

7.2.5 Termination Resistance:

Apply test current of 1A at open circuit voltage of 12V DC to the contacts or connectors in the mated condition, and after the temperature rising becomes stabilized, measure by probing at the point 75mm apart from the wire crimp (across Y-Y' in Fig. 1). Termination resistance is obtained by calculation after deducting the resistance of the 150mm long wire used for termination. The measurement shall be done one after one respectively.

7.2.6 Physical Touch/Feeling at Insertion/Extraction of Contact or Connector:

Tactually inspect the contacts or connectors by mating and unmating paired parts by hands for evidence of any conflict or difficulties perceptible during the operation.

7.2.7 Insulation Resistance:

Insulation resistance shall be tested by applying test potential of 500V DC between the adjacent contacts and between the contacts and the ground of the mated pair of connectors shown in Fig. 2.

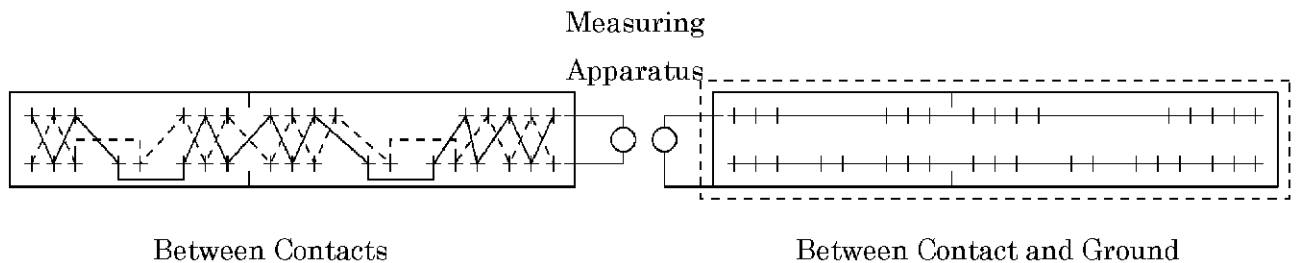
**Fig.2****7.2.8 Dielectric Strength:**

Dielectric Strength shall be measured by applying test potential of 1,800V AC in commercial frequency between the adjacent contacts and between the contacts and the ground of the circuit formed as shown in Fig.2 in the mated pair of connectors for 1 minute.

7.2.9 Current Leakage:

After exposing the mated pair of connector sample in the test chamber where $60 \pm 5^\circ\text{C}$, 90~95% R.H. is maintained for 1 hour, take out from the chamber and apply test potential of 12V DC between the adjacent contacts that are connected as shown in Fig.3. Measure leakage of electric current.

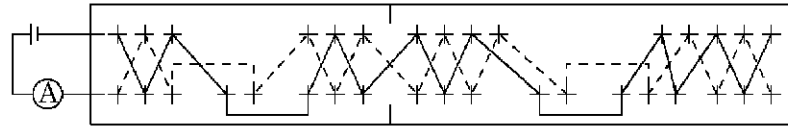
**Fig.3****7.2.10 Contact Retention Force:**

Load contacts in housing that are crimped on approximately 100mm long, 0.85mm^2 or greater wire. Fasten the housing on the tensile testing machine, and apply an axial pull-off load to the crimped wire with the speed at a rate of 100mm a minute. Measure and record the force required to dislodge the contact from the contact position.

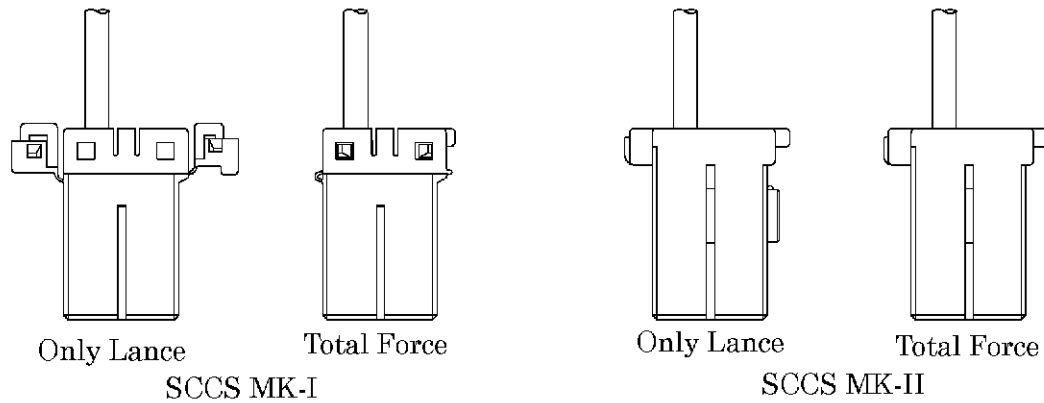
**7.2.11 Crimp Tensile Strength:**

Fasten contact which is crimped on an approximately 100mm long wire, on the tensile testing machine, and apply an axial pull-off load to the crimped wire by operating the head to travel with the speed at a rate of 100mm a minute uniformly. The force required to pull off the wire from the wire crimp or to break the wire shall be measured and recorded.

7.2.12 Housing Retention Force:

Fasten a pair of mated connectors on the tensile testing machine, and with one of the connectors securely held, pull the counterpart connector by operating the head to travel with the speed at a rate of 100mm a minute uniformly. The force required to pull off the wire from the wire crimp or to break the wire, shall be measured and recorded.

7.2.13 Current Cycling:

Apply the test current of calculated intensity obtained from Fig.5, to the four position in the middle of the testing sample connector, and to the remainder contact positions, apply a half intensity current of the specified value, for 45 minutes, and deenergize for 15 minutes. Making this a cycle, repeat for 200 cycle. The test shall be performed in a draft-free chamber.

Table 2

Wire Size (mm ²)	Test Current (DC A)
0.5	11
0.85	14.5
1.25	18.5
2.0	25.0

Number of Positions	Coefficient of Current Loading
1	1
2-3	0.75
4-5	0.6
6-8	0.55
9-12	0.5
13 & Over	0.4

Note: The test current to be loaded for the test is obtained by calculation of the specified intensity designated for the wire size to be used, multiplied by the number of positions and coefficient of current loading, shown in the above tables.

7.2.14 Temperature Rising:

Apply the test current of calculated intensity obtained from Table 2, to the four positions in the middle of the testing sample connector, and to the remainder contact positions, apply a half intensity current of the specified value, for 2 hours, and measure the temperature rising in the middle surface of the housing. From the measured value, subtract the value of room temperature, and confirm the remainder value is less than 65°C. This test shall be performed in the draft-free test chamber.

7.2.15 Repeated Insertion/Extraction:

Securely fasten one of the mated pair of connectors on the tensile testing machine, and operate the head to apply an axial load to the counterpart connector to mate and unmate as the head is travelling at a rate of 100mm a minute. Repeat 50 cycles of insertion and extraction.

7.2.16 "Kojiri" Resistivity:

Securely place one of the mated pair of connectors on the sturdy bench as shown in Fig. 4, and apply reciprocating force to the upper part of the free end of the connectors in the direction perpendicular to connector working axis, at every 1mm graduation from the fully mated depth of the connector until they become unmated. The strokes shall be applied in back/forth direction with a $1.96\text{N}\cdot\text{m}(T)$ torque. Making this one cycle and repeat for 50 cycles. After finishing in back/forth cycling, apply right/left "Kojiri" cycling with the same method for 50 cycles. Make it by fingers if tools cannot be used.

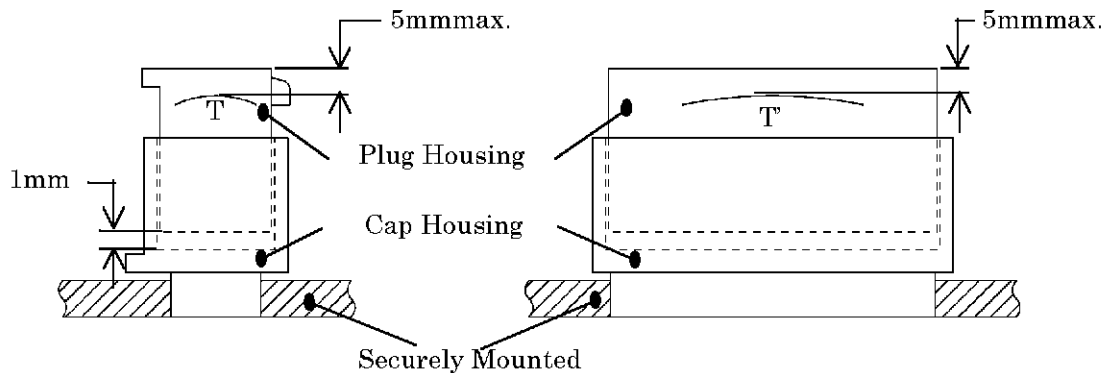

Fig.4

7.2.17 Heat Resistivity:

Expose the mated pair of connectors under the elevated temperature of 80°C in the test chamber for 120 hours. After the test duration, recondition in the room temperature and measure for the subsequent testing.

7.2.18 Cold Resistivity:

Expose the mated pair of connectors under the chilling temperature of -50°C in the test chamber for 120 hours. After the test duration, recondition in the room temperature and measure for the subsequent testing.

7.2.19 Thermal Shock:

Mated pair of connectors shall undergo 5 cycles of temperature changes in the sequence specified in Table 3. After the conditioning, recondition in the room temperature and measure for the subsequent testing.

Table 3

Step	Test Condition
1	$80 \pm 5^{\circ}\text{C}$ 2 hours
2	Room Temperature 5 minutes maximum
3	$-30 \pm 5^{\circ}\text{C}$ 2 hours
4	Room Temperature 5 minutes maximum

7.2.20 Humidity(Steady State):

From a circuit in the mated connectors as specified in Fig. 3, and with the test potential of 28V DC applied to the circuit, expose the sample connectors under the atmosphere of $60 \pm 5^{\circ}\text{C}$, with 90~95% relative humidity in the test chamber for 96 hours. After the test duration, recondition in the room temperature for the subsequent testing.

7.2.21 Salt Spray:

Mated pair of connectors shall be exposed under 5% salt spray in accordance with the test method specified in JIS C 5028. The sample shall undergo exposure for 96 hours and after resting for 1 hour, expose under the salt spray condition for another 96 hours. After completion of the duration, rinse with the tap water to remove salty residue, dry in the room temperature for 1 hour. Then, measure for the subsequent testing.

7.2.22 Dust and Sand Bombardment:

Suspend mated pair of connectors with wire entry of plug housing facing upward as shown in Fig. 5 in the closed test chamber whose dimensions are between 900mm and 1,200mm in width, height and depth, where the connectors are subject to ejection of Portland powdered cement conforming to JIS R 5210 gushed by the aid of compressed air blowing at a rate of 1.5kg per 10 seconds once every 15 minutes. The ejected cement is dispersed with the use of power-driven fan. The test duration should be 1 hour. After completion of test duration, replace the connector sample from the test chamber and measure for the subsequent testing.

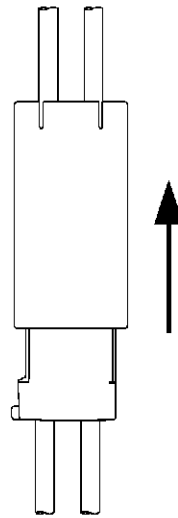
**Fig.5**

7.2.23 Vibration, High Frequency:

Contact-loaded and series wired, mated pair of connectors are vibrated on the vibration testing machine. The vibration shall be such that the frequency range is changing from 20 to 200Hz. reciprocating one cycle a minute, with the accelerated velocity of 4.5G for 8 hours. During the vibration, test current of 1A at open circuit voltage of 12V DC shall be applied to flow through the circuit as shown in Fig. 6, and the circuit shall be monitored for electrical discontinuity greater than 1 microsecond taking place in the circuit.

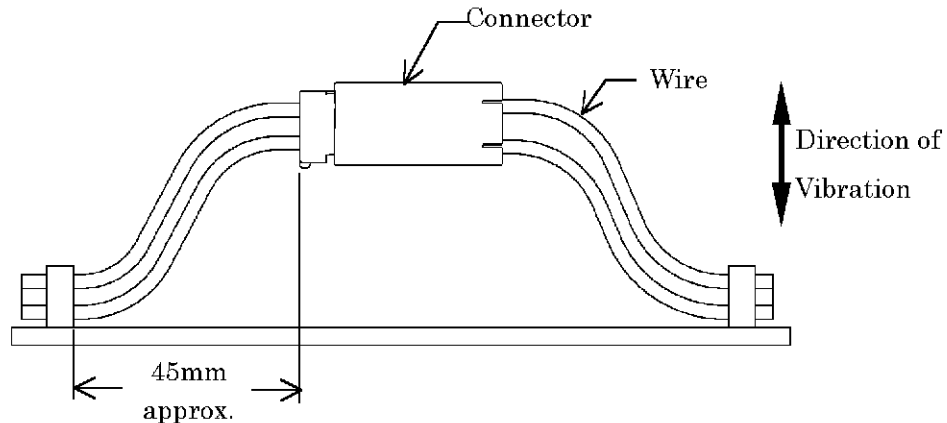

Fig. 6

7.2.24 Current Overload:

Hold the mated pair of connectors horizontally, and apply the test current specified in Table 4 to randomly selected contact position, and observe if the housing starts inflame combustion during energizing for 1 minute.

Table 4

Wire Size (mm ²)	Test Current(DC A)
0.2	—
0.3	—
0.5	50
0.85	75
1.25	100
2.0	200

7.2.25 Contact Loading Force:

Insert wire-crimped contact into housing cavity, and measure the force required to insert and lock the contact in position by travelling the head with the speed at a rate of 100mm a minute approximately.

7.3 Test Sequence:

All the test shall be performed in the sequence specified in Table 5.

Table 5

Classification	Contact		Sample Groups			
	I	II	I	II	III	IV
Test Item	1		1	1	1, 20	1
Appearance	1		1	1	1, 20	1
Contact or Connector Insertion Force	2		2	2	2, 19	
Contact or Connector Extraction Force	5		8	8	8, 18	
Termination Resistance (Low Level)	3		3, 11, 14, 18, 21	3, 11, 15, 18, 22, 25, 28	3, 11, 14	
Termination Resistance	4		4, 12, 15, 19, 22	4, 12, 16, 19, 23, 26, 29	4, 12, 15	
Physical Touch/Feeling at Insertion/Extraction of Connector	6		9, 23	9	9	
Insulation Resistance			6	6	6	
Dielectric Strength			7	7, 13	7, 16	
Current Leakage			5, 16	5, 20	5, 17	
Current Cycling			17			
Temperature Rising			20			
Contact Retention Force			25			
Crimp Tensile Strength		1				
Housing Retention Force			24			
Repeated Insertion/Extraction Force					10	
"Kojiri" Resistivity				24		
Heat Resistivity				10		
Cold Resistivity				14		
Thermal Shock				21		
Humidity (Steady State)				17		
Salt Spray					13	
Dust and Sand Bombardment			13			
Vibration, High Frequency				27		
Current Overload					21	
Contact Loading Force						2

8. Quality Assurance Provisions:**8.1 Test Conditions :**

Unless otherwise specified, all the tests shall be performed under any combination of the following test conditions.

Temperature	15~35°C
Relative Humidity	45~75%
Atmospheric Pressure	86.7~107kPa

8.2 Test and Samples:**8.2.1 Test Specimens:**

The samples to be employed for the tests shall be prepared by using the normal products, prepared in accordance with AMP Application Specifications, 114-5091, 114-5092 and 114-5160, Crimping of 070 Series Contact, crimped on the wires of the sizes specified in Table 7. Unless otherwise specified, no sample shall be reused.

8.2.2 Number of Samples:

The number of the Samples to be used for the tests shall consist of 10 sets minimum of the contacts of each group for testing contacts, and 2 sets minimum of the connectors of each group for testing connectors.

8.2.3 Applicable Wires:

The wires of the following sizes and composition as shown in Table 7 shall be used for preparation of the samples for testing product performance in accordance with specification.

Table 7

Wire Size		Composition of Strands		Calculated Cross section Area of Wire	
Nominal (mm ²)	AWG	Diameter of a Strand(mm)	Number of Strands	mm ²	CMA
0.3	#22	0.26	7	0.37	733
0.5	#20	0.32	7	0.56	1,111
0.85	#18	0.32	11	0.88	1,746
1.25	#16	0.32	16	1.28	2,540
2.0	#14	0.32	26	2.09	4,128

9. Handling Specification:**9.1 Crimping Operation:**

In order to maintain designated performance capability of the product, crimping of contact shall be controlled by AMP Application Specifications, 114-5091, 114-5092 and 114-5160, Crimping of 070 Series Contact.

9.2 Taping of Wires at Assembly of Harness:

In order to maintain proper engagement and retention capability of connectors, wire bundling by tapes shall be controlled to allow slack of wire bundle just next to Wire lead-out of housing as shown in Fig. 8.

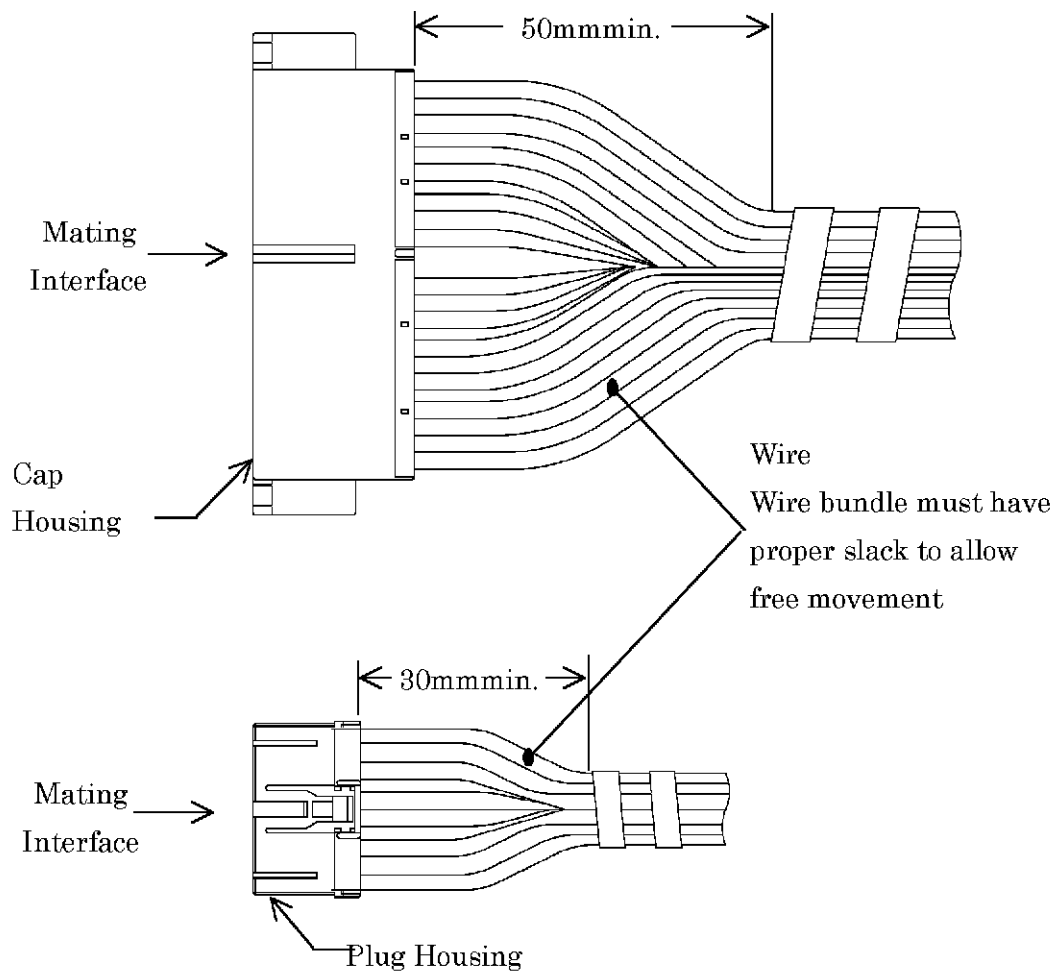
**Fig.8****9.3 Application Tooling:**

For crimping contacts and extracting contacts from loaded housing, use AMP specified extraction tools. (Refer to the Instruction Sheet No. 411-5287,412-5635.)