

**SIDE ENTRY, BOTTOM ENTRY, TOP ENTRY AND TOOLLESS  
MODULAR JACK**

**1. SCOPE.**

This specification covers the performance, tests and quality requirements for the AMP\*:

- SIDE ENTRY, shielded and unshielded, low profile Modular Jacks for printed circuit board application
- BOTTOM ENTRY Modular Jacks for p.c.b. application
- TOP ENTRY , shielded and unshielded, Modular Jacks for p.c.b. application
- TOOLLESS Modular Jack for termination to discrete wires.

**2. APPLICABLE DOCUMENTS.**

The following documents form a part of this specification to the extend specified herein. In the event of conflict between the requirements of this specification and the product drawing, the product drawing shall take precedence. In the event of conflict between the requirements of this specification and the referenced documents, this specification shall take precedence.

IEC 68	Basic environmental testing procedures
IEC 512	Basic testing procedures and measuring methods for electromechanical components for electronic equipment.
IEC 603-7	Connector for frequencies betlow 3 MHz for use with printed boards
FCC 68	Rules for Registration of Telephone Equipment Part 68, Subpart F, connectors.
REA 345-81	PE-76 Bulletin and Specification for Telephone Set Hardware
114-19019	Application Specification for SIDE ENTRY, BOTTOM ENTRY and TOP ENTRY Modular Jack.
114-19020	Application Specification for TOOLLESS Modular Jack
R-041-1409	Test Report, TOOLLESS Modular Jack
R-041-1412	Test Report, BOTTOM ENTRY Modular Jack
R-041-1413	Test Report, BOTTOM ENTRY Modular Jack
R-041-1501	Test Report, SIDE ENTRY Modular Jack
R-041-1604	Test Report, TOOLLESS Modular Jack
R-041-1951	Test Report, 8 pos. BOTTOM ENTRY Modular Jack

DR. M. van ESSEN

DATE 01 Oct 99

APVD Naam

DATE dd Mmm yy

DCR: D20071128083637\_126095

### 3. REQUIREMENTS.

#### 3.1 Design and Construction.

Connectors shall be of the design, construction and physical dimensions specified on the applicable product drawing.

#### 3.2 Materials.

- A. Contact : Phosphor Bronze, nickel underplating all over, goldplating in contact area and tinplating on solder tines.
- B. Barrel contact : Phosphor Bronze, tin coated.
- C. Housing : for SIDE ENTRY:  
Thermoplastic polyester, UL 94HB or UL 94V-O  
for BOTTOM ENTRY  
Nylon, UL 94HB  
for TOP ENTRY  
Thermoplastic polyester, UL 94HB  
for TOOLLESS  
Thermoplastic polyester, UL 94HB

#### **NOTE:**

The operating temperature can be upgraded to 85°C if, for the termination of the Modular Plug, a cable is applied having a high temperature resistant conductor insulation.

The 70°C maximum value is valid for e.g. PVC insulated conductors on the Modular Plug Lead

#### 3.3 Ratings.

- A. Voltage : 150 Vac maximum
- B. Current : 1,5 Amps max. at 30°C  
(see derating curve, figure 7)
- C. Operating temp.: -40°C to 70°C

#### 3.4 Performance and Test description.

Connectors shall be designed to meet the electrical, mechanical and environmental performance requirements specified in figure 1.

**3.5 Test Requirements and Procedures Summary.**

Test Description	Requirement	Procedure
<b>VISUAL</b>		
Examination of product	Meet requirements of product drawing and AMP spec. 114-19019 or 114-19020	Visual, dimensional and functional per applicable inspection plan.
Solderability	Max. 5% de-wetting, inspection with 10 times magnification	Inspect surface of soldering legs visually, after soldering samples mounted on a printed circuit board. Solderbath: 235°C Duration : 2 seconds Ageing : 4 hours at 155°C. Ref.: IEC 68-2-20, test Ta, method 1A.
Resistance to soldering heat.	No functional damage.	Inspect Jack visually after soldering samples on a printed circuit board. Solderbath : 260°C Duration : 5 seconds Ref.: IEC 68-2-20, test Tb, method 1A.
<b>ELECTRICAL</b>		
Termination and wire connection resistance, low level	Termination resistance $\Delta R$ 20 milliohms max. ( $\Delta R$ 30 milliohms max. for TOOLLESS). Wire connection resistance $\Delta R$ 10 milliohms max.	Subject mated Plug and Jack to 20 mV open circuit at 100 mA maximum. See figure 3. Ref.: IEC 512-2, test 2a
Termination and wire connection resistance, rated current.	Termination resistance $\Delta R$ 20 milliohms max. ( $\Delta R$ 30 milliohms max. for TOOLLESS). Wire connection resistance $\Delta R$ 10 milliohms max.	Measure potential drop of mated Plug and Jack while carrying 1,5 Ampère current. Calculate resistance. See figure 3. Ref.: IEC 512-2, test 2b
Dielectric withstanding voltage	1,0 kVac RMS dielectric withstanding voltage, 1 minute hold. One milliampère max. leakage current.	Subject adjacent contacts of mated plug and jack to the specified voltage. TOOLLESS Modular Jack should have terminated wires. Ref.: IEC 512-2, test 4a, method B
Insulation resistance	500 Megohms minimum	Test at 100 V test voltage between adjacent contacts of mated Plug and Jack. Ref.: IEC 512-2, test 3a, method B
Current cycling	Termination and wire connection resistance, rated current.	Subject mated Plug and Jack 50 500 cycles at 125% rated current for 15 minutes "ON" and 15 minutes "OFF". All contacts in series.

**FIGURE 1 (cont'd)**

**3.5 Test Requirements and Procedures Summary (cont'd)**

Test Description	Requirement	Procedure
<b>M E C H A N I C A L</b>		
Jack retention to printed circuit board, before flow soldering.	Jack shall not dislodge from printed circuit board. 4,5 Newtons min.	Apply load to the Jack at a rate of 50 mm per minute, perpendicular to the printed circuit board. Use a printed circuit board with nominal dimensions. See Figure 4
Jack to panel retention.	For TOOLLESS Jack: 300 Newtons min. For BOTTOM ENTRY Jack: 40 Newtons min.	Measure housing retention force using nominal panel or printed circuit board cutout dimensions as specified in the application specification or in the AMP customer drawing. BOTTOM ENTRY Jack should be mated with a plug. See Figure 5
Plug retention in Jack	Plug shall not dislodge from Jack and shall maintain electrical continuity.	Apply axial load of 90 Newton to the cable which is terminated to the Plug at the rate of 25 mm per minute with Plug mated in Jack and latch engaged. SIDE ENTRY and BOTTOM ENTRY Jacks should be soldered to a printed circuit board. TOP ENTRY Jacks should be supported on the panel stops of the housing. TOOLLESS Jacks to be mounted into a panel. See Figure 4. Ref.: IEC 512-8, test 15f
Vibration	No discontinuities greater than 1 microsecond. Termination and wire connection resistance low level. Shal remain mated and show no evidence of physical damage.	Subject Modular Jack and Modular Plug to sinusoidal vibration along each of 3 mutually perpendicular axes. 10 Cycles at a level of 50 m/s <sup>2</sup> from 10-500 Hz at a rate of 1 octave/minute. (Duration approx. 3x2 hours.) Ref.: IEC 68-2-6, test Fc.
Mating and unmating force	25 Newtons max.	Measure force necessary to mate Plug and Jack and to unmate with Plug latch depressed, at a rate of 25 mm per minute. Ref.: IEC 512-7, test 13b.
Durability	Termination resistance, low level. No functional damage.	Mate and unmate Plug and Jack for N=750 cycles total at a maximum rate of 500 cycles/hour and a speed of 10 mm/s, latch inoperative. Ref.: IEC 512-5, test 9a
Wire retention.	For 26 AWG wire: 20 Newtons. min. For 24 AWG wire: 30 Newtons. min. For 22 AWG wire: 35 Newtons. min.	Apply axial load to the wire extending fom each barrel contact at a rate of 25 mm/minute, stuffer cap installed. See figure 6.
6 Position Plug in 8 Position Jack.	Termination resistance, low level. No functional damage.	Resistance measurements should be done with 6 and 8 position Plug. Durability and dry heat to be tested with 6 position Plug

**FIGURE 1. (cont'd)**

**3.5 Test Requirements and Procedures Summary (cont'd)**

Test Description	Requirement	Procedure
<b>ENVIRONMENTAL</b>		
Thermal shock	Insulation resistance. Termination and wire connection resistance, low level. No functional damage.	Subject mated Plug and Jack to 25 cycles between -40°C and 70°C. The duration at the extreme temperatures shall be 30 minutes. Ref.: IEC 68-2-14, test N.
Temperature – humidity cycling.	Insulation resistance after final cycle. Termination and wire connection resistance, low level.	Subject mated Plug and Jack to 10 temperature – humidity cycles between 25°C and 55°C at 95% RH. Ref.: IEC 68-2-30, test Db.
Dry heat.	Termination and wire connection resistance, low level	Subject mated Plug and Jack for 500 hours to a temperature of 70°C. Ref.: IEC 68-2-2, test Ba.

**FIGURE 1. (end)**

**3.6 Connector Qualification and Requalification Test and Sequence**

Test or Examination	Test Group (a)									
	1	2	3	4	5	5a	6	7	8	9
Examination of product	1	1	1	1	1	1	1	1	1	1
Termination/connection* resistance, low level	2,4		2,4		4,7,9		2,4			
Termination/connection* resistance, rated current		2,4								
Insulation resistance				2,5				2,5		
Dielectric withstanding voltage				3,6				3,6		
Current cycling		3								
Temperature – humidity cycling			3	4						
Thermal Shock							3	4		
Dry Heat					6					
Vibration	3									
Mating force					2					
Unmating force					3					
Durability (½N)					5,8					
Plug retention in Jack									2	
Wire retention*									3	
Jack to panel retention*									4	
Jack retention to printed circuit board*									5	
Solderability*										2
Resistance to soldering heat*										3
6 Position Plug in 8 position Jack:*										
Termin./conn.* resistance, low level 8 pos. Plug						2,9				
Termin./conn.* resistance, low level 6 pos. Plug						3,6,8				
Durability (½N), 6 position Plug						4,7				
Dry heat, 6 position plug						5				

\* If applicable

(a) See Par 4.1.

(b) Numbers indicate sequence in which tests are performed

**FIGURE 2.**

#### 4. QUALITY ASSURANCE PROVISIONS.

##### 4.1 Qualification Testing.

###### A. Sample Selection.

Modular Jack test samples shall be selected at random from current production lots. They shall be prepared for testing in accordance with current application specification and instruction sheets.

###### B. Test Sequence.

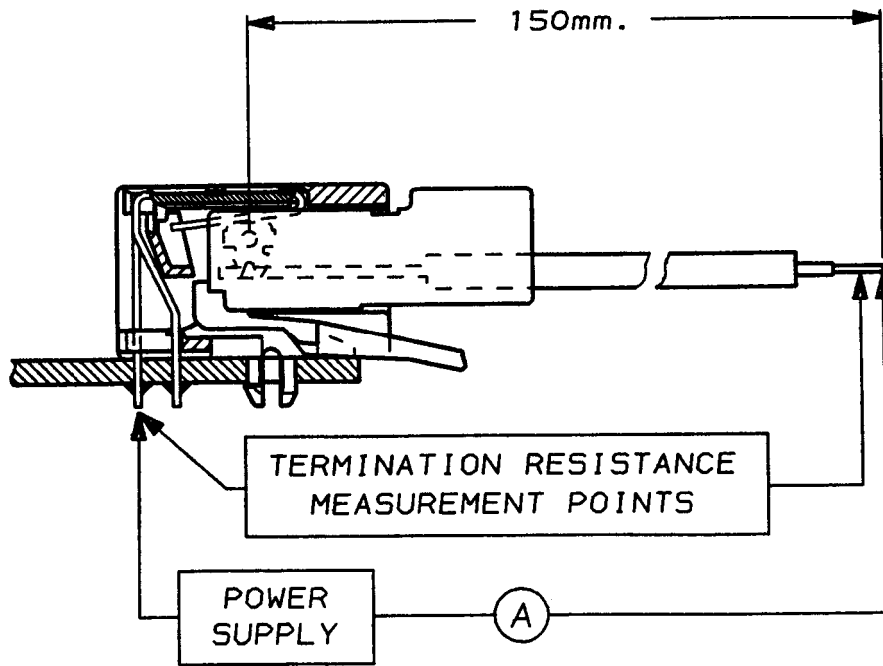
Qualification testing shall be conducted as specified in figure 2.

###### C. C. Acceptance:

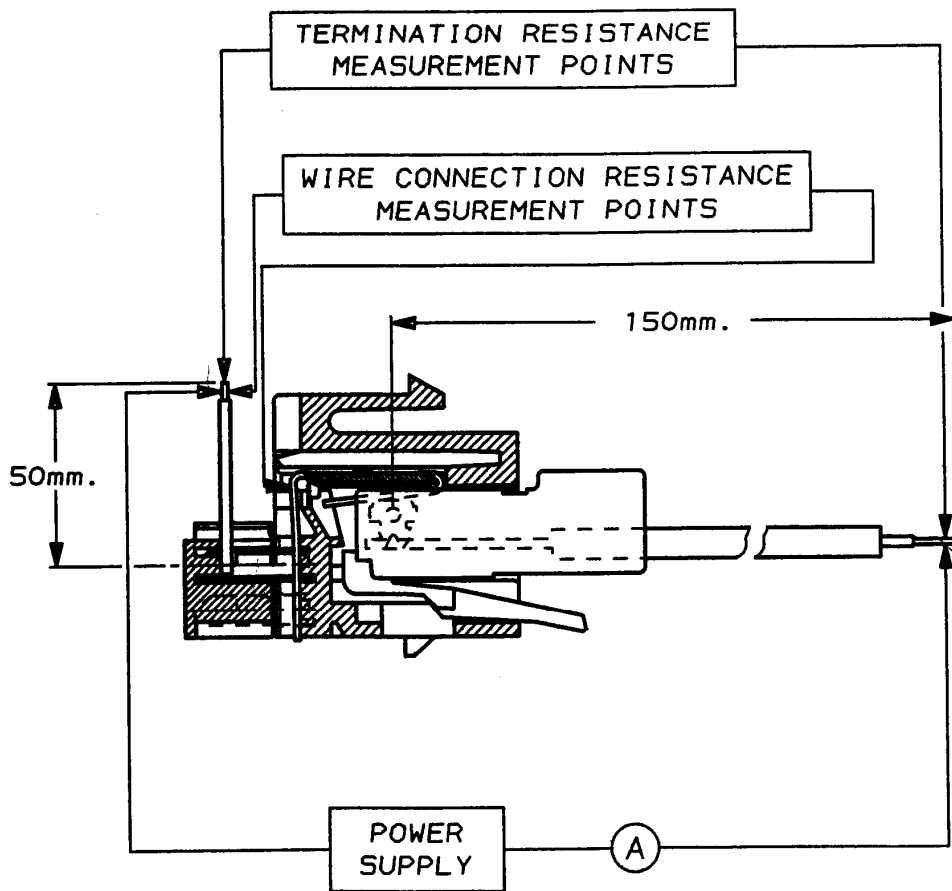
1. All samples tested in accordance with this specification shall meet the requirements as indicated in the requirements portion of Figure 1.
2. Failures attributed to equipment, test setup, or operator deficiencies shall not disqualify the product. when product failure occurs, corrective action shall be taken and samples resubmitted for qualification.

##### 4.2 Quality Conformance Inspection.

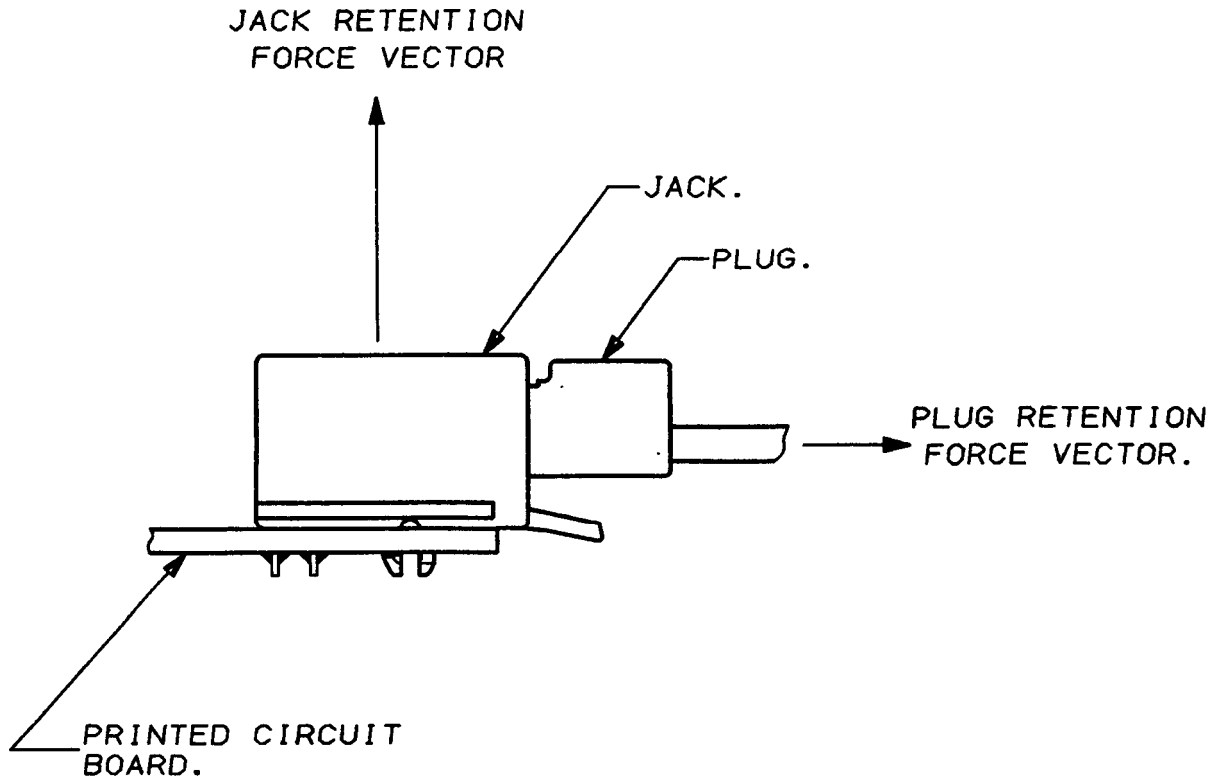
The applicable AMP Inspection plan will specify the sampling acceptable quality level to be used. Dimensional and functional requirements shall be in accordance with the applicable product drawing and this specification.



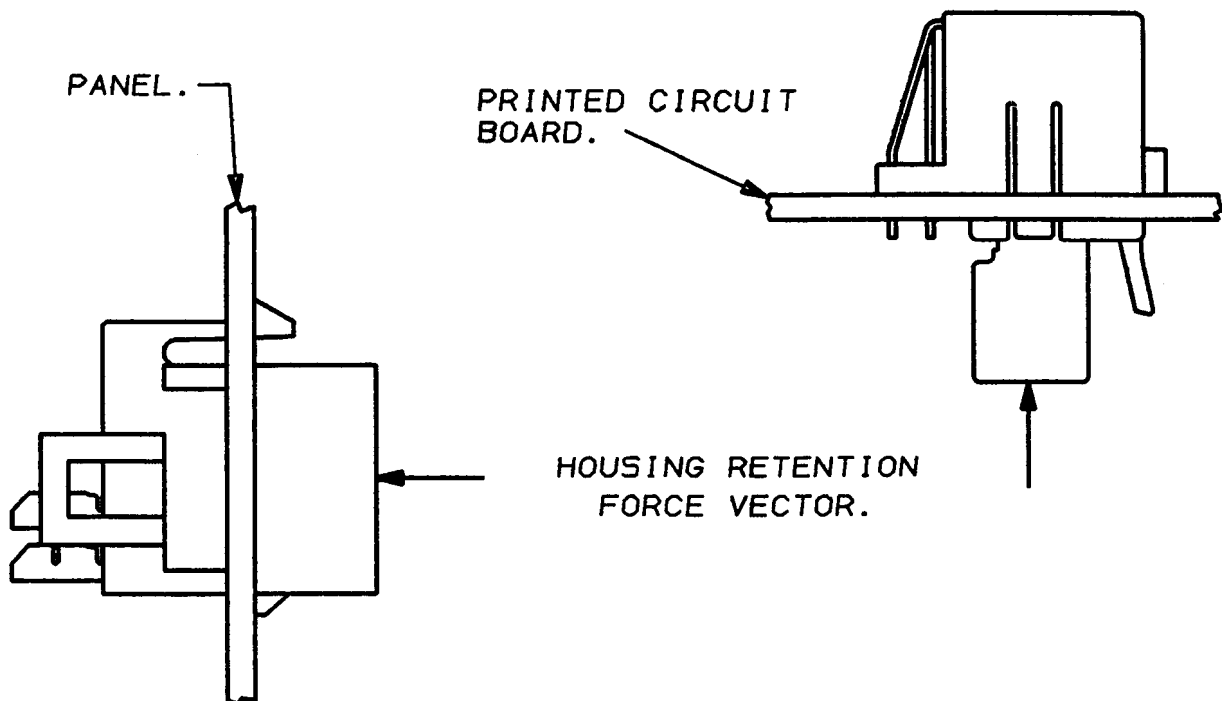
**FIGURE 3A. SIDE, BOTTOM and TOP ENTRY**



**FIGURE 3B. TOOLLESS**

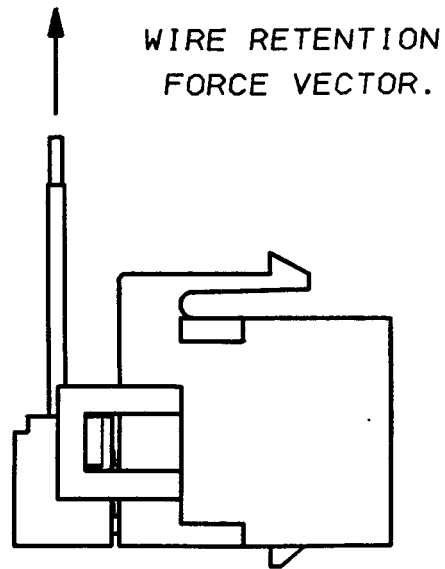


**FIGURE 4.**



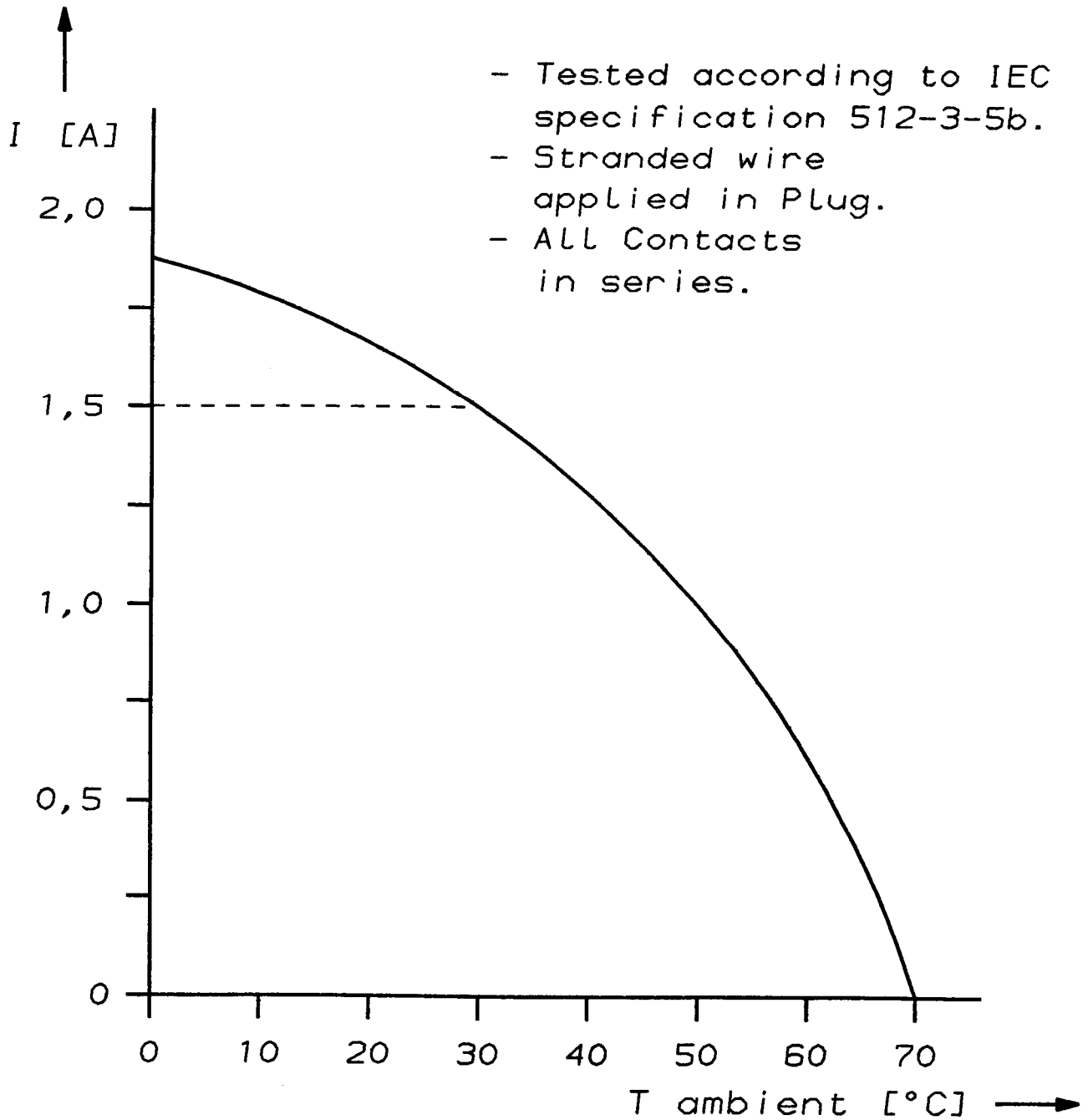
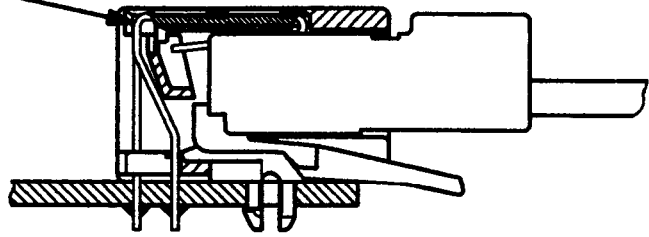
**FIGURE 5.**





**FIGURE 6.**

Temperature measurement spot.



**FIGURE 7.**

## 5. SHIELDED MODULAR JACKS.

### 5.1 SCOPE.

This specification cover the shielding effectiveness and dielectric withstanding voltage performance and tests for AMP:

- shielded Side Entry low profile Modular Jack
- shielded Top Entry Modular Jack

This is in addition to the requirements and tests specified in 108-19064.

### 5.2 TEST REQUIREMENTS AND PROCEDURE.

Test description	Requirement	Procedure
Shielding Effectiveness	Frequency: 30 Mhz to 400 Mhz  Reduction: 20 dB min.	Measure radiated response from unshielded mated jack and plug terminated with unshielded cable, while conductors are excited between 300 and 400 Mhz frequency. Repeat procedure using shielded jack mated with shielded plug terminated with Aluminum/Mylar shielded cable; the difference in response is shielding effectiveness in dB; AMP Spec. 109-90
Dielectric withstanding voltage between contacts and shield	1500 Vac RMS dielectric withstanding voltage, 1 minute hold. One milliampère max. leakage current.	Subject all contacts of Jack mated with a plug and shield to the specified voltage. Ref.: IEC 512-2, test 4a, method B

### 5.3 SAMPLE SELECTION AND ACCEPTANCE.

10 Test samples of Modular Jack and of Modular Plug shall be selected at random from current production lots. They shall be prepared for testing in accordance with current Application Specification and Instruction Sheet.

Acceptance is based on verification that the product meets the requirements. Failures attributed to equipment, test set-up or operator deficiencies shall not disqualify the product. When product failure occurs, corrective action shall be taken and samples resubmitted for qualification.

### 5.3.1 TESTGROUP 1

1. Examination of product
2. Shielding effectiveness

### TESTGROUP 2

1. Examination of product
2. Dielectric withstanding voltage
  - a) between contacts: 1000 Vac, 1 minute
  - b) between contacts / shield: 1500 Vac, 1 minute
1. Temperature – humidity cycling  
10 cycles 25°C / 55°C at 95% R.H.  
Ref. IEC 68-2-20, test Db
2. Dielectric withstanding voltage
  - a) between contacts: 1000 Vac, 1 minute
  - b) between contacts / shield: 1500 Vac, 1 minute