

EP II Connector System

1. INTRODUCTION

1.1 Purpose

Testing was performed on the TE Connectivity (TE) Economy Power (EP) II Connector System to determine its conformance to the requirements of Product Specification 108-2297, Revision B.

1.2 Scope

This report covers the electrical, mechanical, and environmental performance of the Economy Power (EP) II Connector System. Testing was performed at the Harrisburg Electrical Components Test Laboratory between January 19, 2012 and May 2, 2012. The test file numbers for this testing are EA20110905T. This documentation is on file at and available at the above listed laboratory.

1.3 Conclusion

All part numbers listed in paragraph 1.5 conformed to the electrical, mechanical, and environmental performance requirements of Product Specification 108-2297, Revision B.

1.4 Product Description

The Economy Power (EP) II Connector System is used for wire-to-board interconnection and mates with EP headers.

1.5 Test Specimens

The test specimens were representative of normal production lots, and the following part numbers were used for this test program (See Table 1).

Table 1 – Test Specimens

| Test Group | Qty | Part Number | Description |
|-----------------|--------|--------------------|-----------------------------------|
| 1 | 60 | 1744201-1 Rev B | Receptacle Contact on 18 AWG wire |
| 2 | 60 | 1744201-1 Rev B | Receptacle Contact on 16 AWG wire |
| | 60 | 1-1744144-1 Rev C | Receptacle Contact on 18 AWG wire |
| | 36 | 1744144-1 Rev C | Receptacle Contact on 22 AWG wire |
| | 36 | 1744201-1 Rev B | Receptacle Contact on 20 AWG wire |
| 3 | 36 | 1744201-1 Rev B | Receptacle Contact on 16 AWG wire |
| | 36 | 1744144-1 Rev C | Receptacle Contact on 18 AWG wire |
| 4 | 30 | 1744201-1 Rev B | Receptacle Contact on 16 AWG wire |
| | 30 | 1744144-1 Rev C | Receptacle Contact on 18 AWG wire |
| | 30 | 1744144-1 Rev C | Receptacle Contact on 22 AWG wire |
| | 30 | 1744201-1 Rev B | Receptacle Contact on 20 AWG wire |
| 5 | 60 | 1744144-1 Rev C | Receptacle Contact on 18 AWG wire |
| 6 | 36 | 1744201-1 Rev B | Receptacle Contact on 18 AWG wire |
| | 36 | 1744201-1 Rev B | Receptacle Contact on 16 AWG wire |
| 7 | 60 | 1744201-1 Rev B | Receptacle Contact on 18 AWG wire |
| 8 | 60 | 1744201-1 Rev B | Receptacle Contact on 18 AWG wire |
| 9 | 60 | 1744201-1 Rev B | Receptacle Contact on 18 AWG wire |
| 1,2,3,5,7,8,9 | 5 each | 1-2132781-2 Rev A | 12 Position Housing |
| 1,2,3,5,6,7,8,9 | 5 each | 1-1744057-2 Rev B | 12 Position Header |
| 1, 2,3,7,8,9 | 5 each | 1-2132782-2 Rev A | Retainer |
| 1, 2, 7, 8, 9 | 5 each | 60-1042501-1 Rev O | EP II Printed Circuit Board |

Note: Test Group 2 end of life testing was performed on 16 AWG specimens only. All other wire sizes were utilized to establish the Current Rating Factor (F) Table information.

1.6 Qualification Test Sequence

The specimens identified in Table 1 were subjected to the tests listed in Table 2.

Table 2 – Test Sequence

| Test or Examination | Test Group (a) | | | | | | | | |
|--------------------------------|-------------------|------|-----|---|---|---|-----|-----|-----|
| | 1 | 2 | 3 | 4 | 5 | 6 | 7 | 8 | 9 |
| | Test Sequence (b) | | | | | | | | |
| Initial examination of product | 1 | 1 | 1 | 1 | 1 | 1 | 1 | 1 | 1 |
| Low level contact resistance | 3,7 | 2,7 | | | | | 2,4 | 2,4 | 2,4 |
| Insulation resistance | | | 2,5 | | | | | | |
| Withstanding voltage | | | 3,6 | | | | | | |
| Temperature rise vs. current | | 3,8 | | | | | | | |
| Random vibration | 5 | 6(c) | | | | | | | |
| Mechanical Shock | 6 | | | | | | | | |
| Durability | 4 | | | | | | | | |
| Mating force | 2 | | | | | | | | |
| Unmating force | 8 | | | | | | | | |
| Crimp tensile | | | | 2 | | | | | |
| Contact retention | | | 7 | | | | | | |
| Connector locking strength | | | | | 2 | | | | |
| Contact insertion force | | | | | | 2 | | | |
| Thermal shock | | | 4 | | | | | | |
| Humidity/temperature cycling | | 4(d) | | | | | | | |
| Temperature life | | 5 | | | | | | | |
| Salt spray | | | | | | | 3 | | |
| Hydrogen sulfide | | | | | | | | 3 | |
| Ammonia | | | | | | | | | 3 |
| Final examination of product | 9 | 9 | 8 | 3 | 3 | 3 | 5 | 5 | 5 |

- NOTE: (a) See paragraph 1.5
 (b) Numbers indicate sequence which tests were performed.
 (c) Discontinuities shall not be measured. Energize at 18°C level for 100% loadings.
 (d) Precondition specimens with 10 durability cycles.

1.7 Environmental Conditions

Unless otherwise stated, the following environmental conditions prevailed during testing:

Temperature: 15°C to 35°C
 Relative Humidity 20% to 80%

2. SUMMARY OF TESTING

2.1 Initial Examination of Product – All Test Groups

A Certificate of Conformance stating all specimens submitted for testing were representative of normal production lots and met the requirements of the applicable product drawing was provided. Where specified, specimens were visually examined, and no evidence of physical damage detrimental to product performance was observed.

2.2 Low Level Contact Resistance (LLCR) – Test Groups 1, 2, 7, 8, and 9

All initial low level contact resistance readings were less than the initial maximum requirement of 10 milliohms; and all final measurements were less than the final maximum requirement of 20 milliohms. Refer to Tables 2 and 3 for the resistance summary data (data does not include wire bulk).

Table 2 – Low Level Contact Resistance (milliohms)

| | Test Group 1, 18 AWG | | Test Group 2, 16 AWG | |
|------------|-------------------------|-------|-------------------------|-------|
| | Initial | Final | Initial | Final |
| Min | 1.14 | 1.30 | 1.10 | 1.99 |
| Max | 1.54 | 3.10 | 1.75 | 4.66 |
| Avg | 1.25 | 1.80 | 1.23 | 2.83 |
| Std | 0.06 | 0.28 | 0.10 | 0.57 |

Table 3 – Low Level Contact Resistance (milliohms)

| | Test Group 7, 18 AWG | | Test Group 8, 16 AWG | | Test Group 9, 18 AWG | |
|------------|-------------------------|---------------------|-------------------------|------------------------------|-------------------------|------------------|
| | Initial | After Salt Spray | Initial | After Hydrogen Sulfide | Initial | After Ammonia |
| Min | 1.21 | 1.26 | 1.21 | 1.26 | 1.19 | 1.24 |
| Max | 1.44 | 1.61 | 1.44 | 1.61 | 1.42 | 1.56 |
| Avg | 1.30 | 1.40 | 1.30 | 1.40 | 1.28 | 1.34 |
| Std | 0.04 | 0.08 | 0.04 | 0.08 | 0.04 | 0.06 |

2.3 Insulation Resistance – Test Group 3

All initial insulation resistance measurements were greater than the minimum requirement of 1000 megohms. All final insulation resistance measurements were greater than the minimum requirement of 500 megohms.

2.4 Withstanding Voltage – Test Group 3

No breakdown or flashover occurred either initially or after environmental exposure.

2.5 Temperature Rise vs. Current – Test Group 2

Temperature Rise testing was performed and the current rating curve (Figure 1) is listed below along with the current rating factors (F) table with the percent loading and the corresponding values to be used per wire size (Table 4).

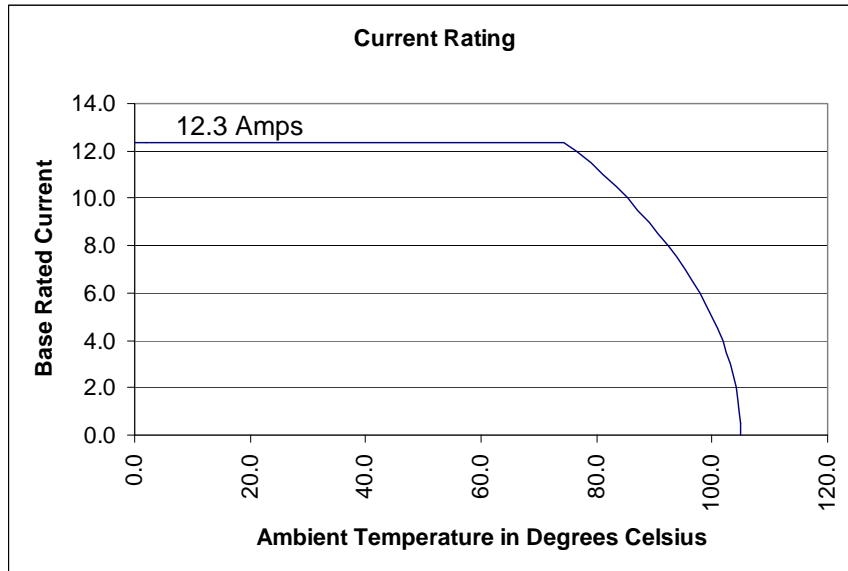

Figure 1 – Current Rating Curve

Table 4 – Current Rating Factors (F)

| Wire Size (AWG) | 22 | 20 | 18 | 16 |
|------------------------|-------|-------|-------|-------|
| Loading Density | | | | |
| Single | 0.750 | 0.818 | 0.899 | 1.0 |
| 50% | 0.587 | 0.639 | 0.703 | 0.782 |
| 100% | 0.435 | 0.475 | 0.522 | 0.580 |

2.6 Random Vibration – Test Groups 1 and 2

No discontinuities were detected during vibration. Following vibration, no cracks, breaks, or loose parts on the specimens were visible. Test Group 2 specimens were energized during vibration testing.

2.7 Mechanical Shock – Test Group 1

No discontinuities were detected during mechanical shock. Following mechanical shock testing, no cracks, breaks, or loose parts on the specimens were visible.

2.8 Durability – Test Group 1

No physical damage occurred to the specimens as a result of mating and unmating the specimens 15 times.

2.9 Mating Force – Test Group 1

All mating forces were less than the maximum requirement of 9.8 N (2.2 lbf) per contact.

2.10 Unmating Force – Test Group 1

All unmating forces were greater than the minimum requirement of 0.9 N (0.22 lbf) per contact.

2.11 Crimp Tensile – Test Group 4

All crimp tensile measurements were greater than the minimum requirements of 44.5 N (10 lbf) for 22 AWG, 62.3 N (14 lbf) for 22 AWG, 89 N (20 lbf) for 18 AWG, and 100 N (22.5 lbf) for 16 AWG.

2.12 Contact Retention – Test Group 3

All contact retention forces were greater than the minimum requirement of 29.4 N (6.6 lbf) per contact.

2.13 Connector Locking Strength – Test Group 5

All connector locking strength forces were greater than the minimum requirement of 111 N (25 lbf).

2.14 Contact Insertion Force – Test Group 7

All contact insertion forces were less than the maximum requirement of 6.9 N (1.5 lbf) per contact.

2.15 Thermal Shock – Test Group 3

No evidence of physical damage was visible as a result of exposure to thermal shock.

2.16 Humidity/temperature Cycling – Test Group 2

No evidence of physical damage was visible as a result of exposure to humidity-temperature cycling.

2.17 Temperature Life – Test Group 2

No evidence of physical damage was visible as a result of exposure to temperature life.

2.18 Salt Spray – Test Group 7

No evidence of physical damage was visible as a result of exposure to salt spray.

2.19 Hydrogen Sulfide – Test Group 8

Post test visual examination of the test specimens showed no physical damage as a result of exposure to a H₂S environment.

2.20 Ammonia – Test Group 9

Post test visual examination of the test specimens showed no physical damage as a result of exposure to an ammonia environment.

2.21 Final Examination of Product – All Test Groups

Specimens were visually examined and no evidence of physical damage detrimental to product performance was observed.

3. TEST METHODS

3.1 Initial Examination of Product

A Certificate of Conformance was issued stating that all specimens in this test package were produced, inspected, and accepted as conforming to product drawing requirements, and were manufactured using the same core manufacturing processes and technologies as production parts.

3.2 Low Level Contact Resistance

Contact resistance measurements at low level current were made using a four terminal measuring technique. The test current was maintained at 100 mA maximum with a 20 mV maximum open circuit voltage. All wire bulk was removed from the measurements. Refer to Figure 2 for a detailed drawing of the measurement points.

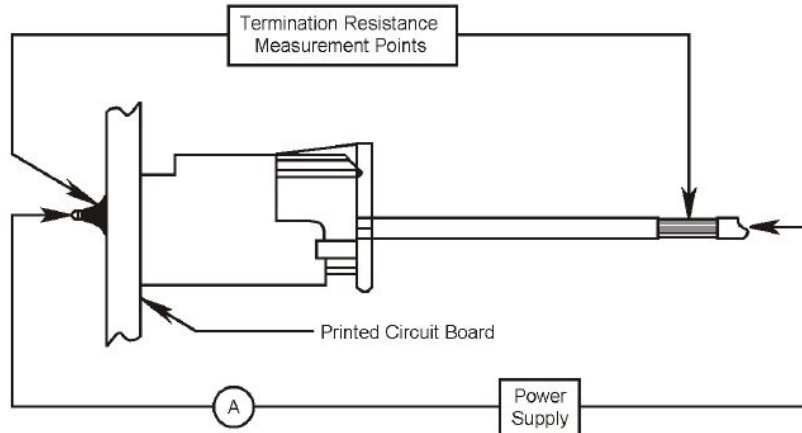

Figure 2 – Low Level Contact Resistance Measurement Points

3.3 Insulation Resistance

A potential of 500 VDC was applied between adjacent contacts of unmounted, mated connectors and held for two minutes. Readings were recorded after two minutes.

3.4 Withstanding Voltage

A potential of 1500 VAC was applied between adjacent contacts of unmounted, mated connectors at a rate of 500 volts per minute and held for one minute. The leakage current was set for 5.0 milliamps.

3.5 Temperature Rise vs. Current

The specimens were energized at various current levels and loading densities with DC current while the temperature rise was measured. The initial temperature rise data was used to establish the F-factor table values, and the final data (on the largest wire size) was used to establish the base rated current curve. Measurements were recorded once stabilization occurred (when the temperature rise of three consecutive readings taken at five minute intervals did not differ by more than 1°C).

3.6 Random Vibration

The test specimens were subjected to a random vibration test. See Figures 3 and 4 for vibration setup photographs. The parameters of this test condition are specified by a random vibration spectrum with excitation frequency bounds of 20 and 500 Hertz (Hz). The spectrum remains flat at 0.02 G²/Hz from 20 Hz to the upper bound frequency of 500 Hz. The root-mean square amplitude of the excitation was 3.10 GRMS. The test specimens were subjected to this test for 15 minutes in each of the three mutually perpendicular axes, for a total test time of 45 minutes per test specimen. The test specimens were monitored for discontinuities of 1 microsecond or greater using an energizing current of 100 milliamperes.

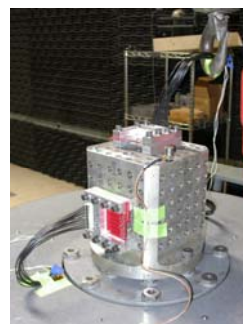

**Figure 3
Vertical & Lateral
Axes**

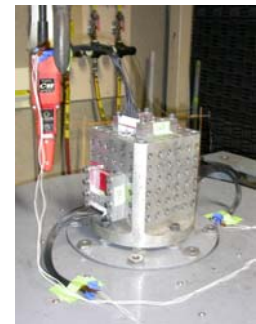

**Figure 4
Vertical & Longitudinal
Axes**

Test Group 1 specimens were monitored for discontinuities and Test Group 2 specimens were energized.

3.7 Mechanical Shock

The test specimens were subjected to a mechanical shock test. The parameters of this test condition are a half-sine waveform with an acceleration amplitude of 30 gravity units (g's peak) and a duration of 11 milliseconds. Three shocks in each direction were applied along the three mutually perpendicular axes of the test specimens, for a total of eighteen shocks. The test specimens were monitored for discontinuities of 1 microsecond or greater using an energizing current of 100 milliamperes.

3.8 Durability

Durability was performed by mating and unmating the specimens 15 times by hand. The cycle rate did not exceed 500 cycles per hour.

3.9 Mating Force

The specimens were fixtured in the manner shown in Figure 5. The crosshead was lowered at a rate of 0.5in/min until the specimens were fully mated.

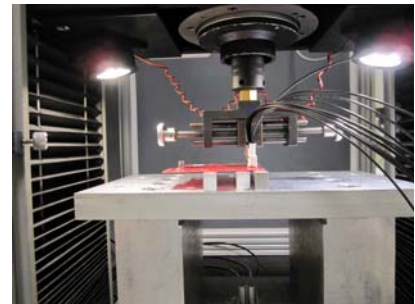

Figure 5 - Mating Force Setup

3.10 Unmating Force

Prior to testing, the latches on the connector housings were rendered inoperable. The specimen header mounted to a PCB was secured to an X-Y table and the connector housing was held in a vice mounted to the load cell. The load cell was raised at a rate of 0.5in/min until the connector housing was removed from the header. The maximum force required to remove the connector housing from the header was recorded.

3.11 Crimp Tensile

Specimens were held in a slotted plate and goal post fixture with a slotted plate slot width of 0.065 inch. The slotted plate and goal post was mounted to an X-Y table. The wire lead was secured to an air jaws mounted to the load cell and raised at a rate of 25.4mm/min until the wire was removed from the crimp. The maximum load required to remove the wire from the contact, and the failure method was recorded.

3.12 Contact Retention

Contact retention was measured by applying a minimum axial load of 29.4 N (6.6 lbs) for six seconds. A crosshead speed of 0.5 in/min was used during the test. Figure 6 shows the set-up used for this test.

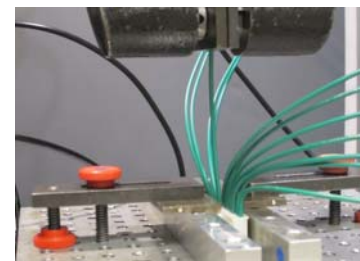

Figure 6 - Contact Retention Setup

3.13 Connector Locking Strength

Prior to testing, the connector housing lip, opposite the side of the connector locking mechanism, was removed to provide a flush surface for mounting into a vice. The connector housings were secured by two vices mounted to an X-Y table. The connector housings were held in the vices in a manner that would not influence the connector locking mechanism during testing (one vice on each side of the connector locking mechanism). The header was secured in a vice attached to the load cell mounted to the crosshead. The crosshead was raised at a rate of 0.5 in/min until the header was removed from the connector housing. The maximum force required to separate the connector housing from the header was recorded; see Figure 7 for an image of the setup.

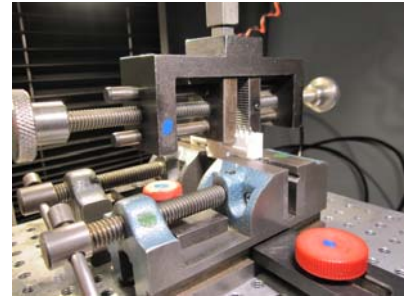

Figure 7 - Locking Strength Test

3.14 Contact Insertion Force

Connector housings were secured to an X-Y table in a manner that would not prevent the contact retainer feature from operating while the contact was inserted into the housing. The contacts were trimmed of excessive wire bulk as close to the wire insulation crimp without damaging the crimp. The contacts were then inserted into the connector housing using a drill rod attached to the load cell. The contacts were inserted at a rate of 0.5 in/min until the contact was fully inserted. The maximum force required to insert the contact into the connector housing was recorded; see Figure 8 for an image of the setup.

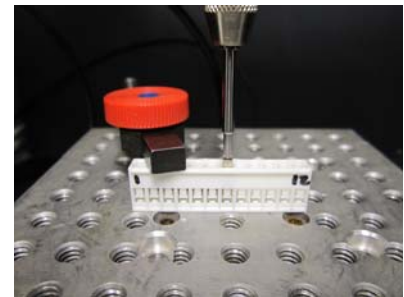

Figure 8 - Contact Insertion

3.15 Thermal Shock

Mated specimens were subjected to 10 cycles of thermal shock with each cycle consisting of 30 minute dwells at -55°C and 105°C.

3.16 Humidity/temperature Cycling

Mated specimens were exposed to 10 cycles of humidity-temperature cycling. Each cycle lasted 24 hours and consisted of cycling the temperature between 25°C and 65°C at 80 to 100% RH. Specimens were preconditioned with 10 cycles of durability prior to exposure.

3.17 Temperature Life

Mated specimens were exposed to a temperature of 105°C for 500 hours.

3.18 Salt Spray

Specimens were hung from horizontal rods using fishing line attached to one end of the specimen. The test specimens were subjected to a 5% salt concentration environment for a period of 48 hours. At the completion of the exposure period the specimens were rinsed off with tap water, gently blown with compressed air to remove excess water then oven dried at 38°C for approximately 3 hours.

3.19 Hydrogen Sulfide

Mated specimens were subjected to a 3±1 ppm H₂S gas concentration maintained at 40°C ± 2°C for 96 hours.

3.20 Ammonia

Mated specimens were subjected to a 3% ammonia solution for 7 days.

3.21 Final Examination of Product

Specimens were visually examined and no evidence of physical damage detrimental to product performance was observed.