

MicroStac

0.8 mm Connectors

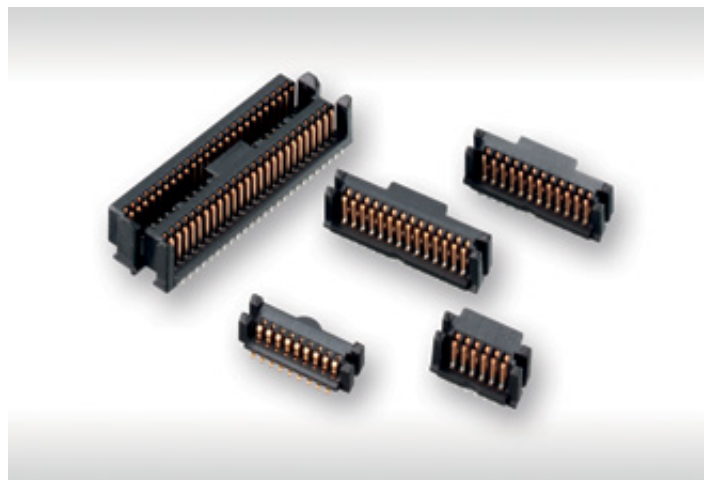
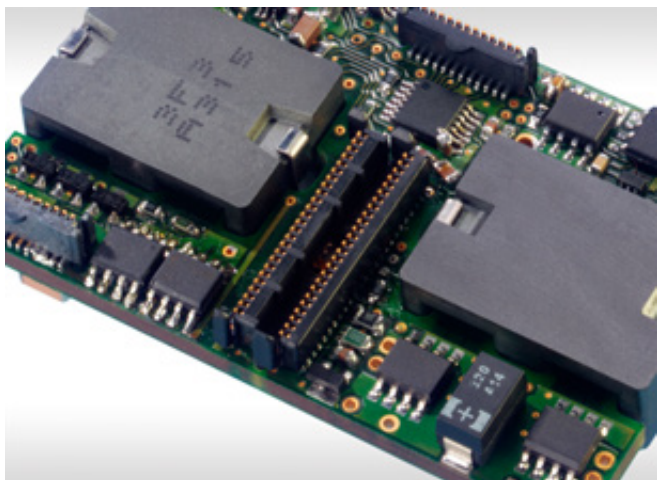
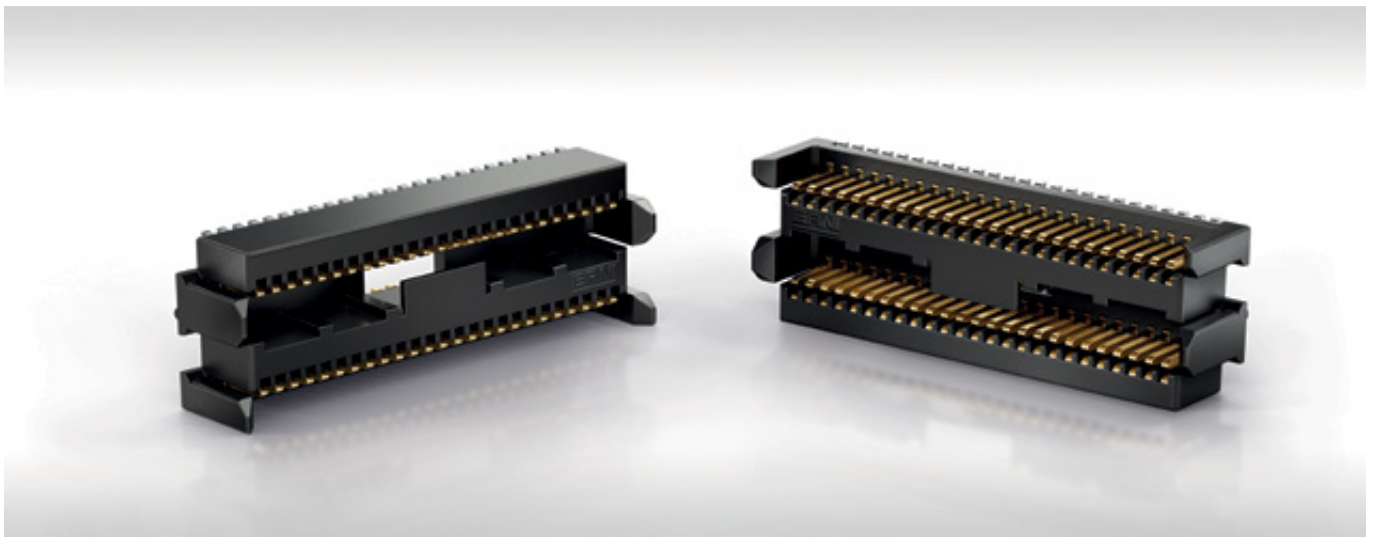

MicroStac - MEZZANIN CONNECTOR SYSTEM

The MicroStac connector series features hermaphroditic mating design within a pitch of 0.8 mm. Connectors and their mating connectors are identical. This reduces the bill of material and also storage and handling costs. Two contact points between mated contacts and the wipe length of up to 1.5 mm provide a high reliability.

The design calls for fast automatic Surface Mount Technology (SMT) assembly. MicroStac connectors are available for Board-to-Board heights of 3 mm and 5 mm. Despite their small size, MicroStac connector contacts offer large radiating surfaces to provide a high current rating.

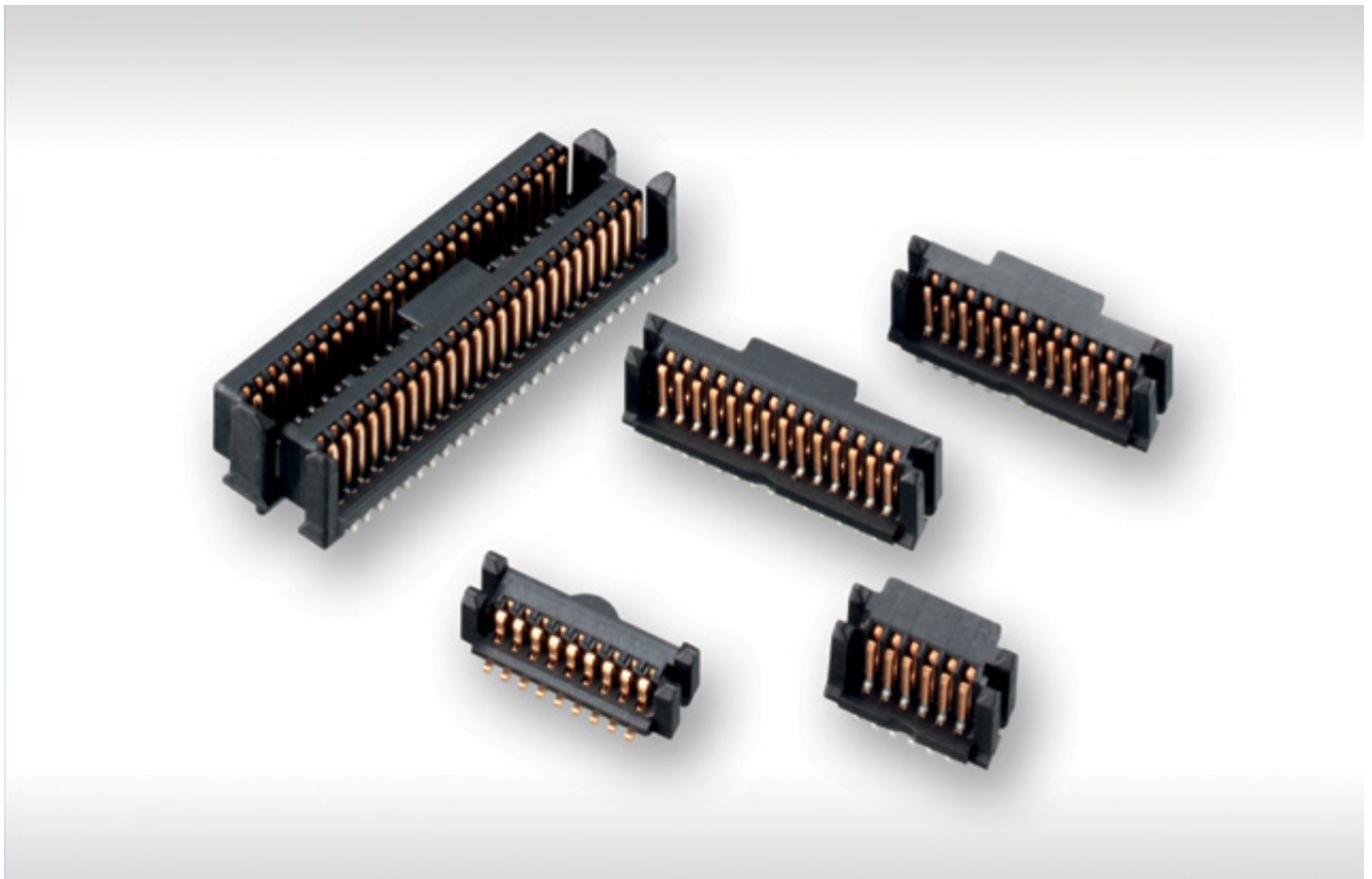

FEATURES

Pitch	0.8 mm
No. of Pins	6, 9, 10, 12, 14, 50, 54
Current rating per contact	up to 2.7 A
Termination technology	SMT
Applications	stacked boards (Mezzanine)
Board-to-Board height	3 mm, 5 mm
Weight	0.18 g (6-pin version)
Variants	single row connectors dual row connectors

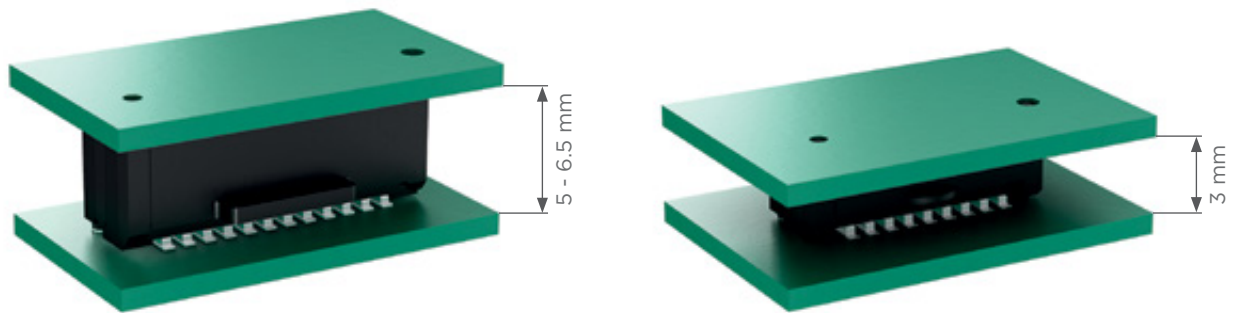

Wipe length

- 5 mm board height: 1.5 mm
- 3 mm board height: 0 mm

CAPABILITIES

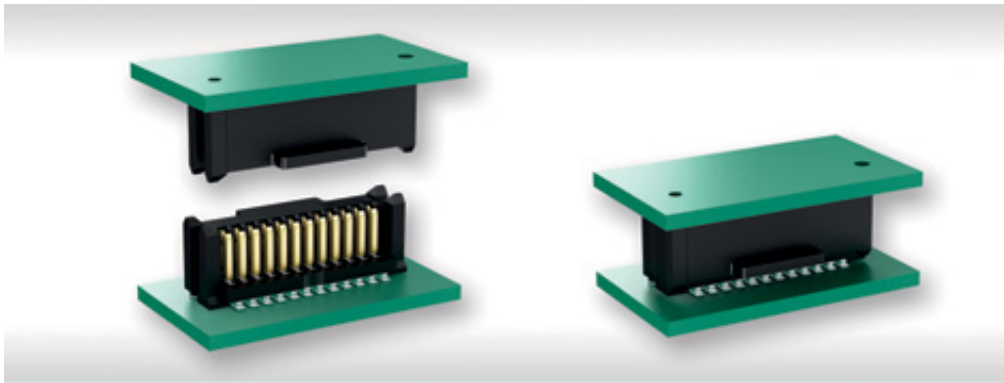

- stacked boards (mezzanine) single row version (5 mm board height)

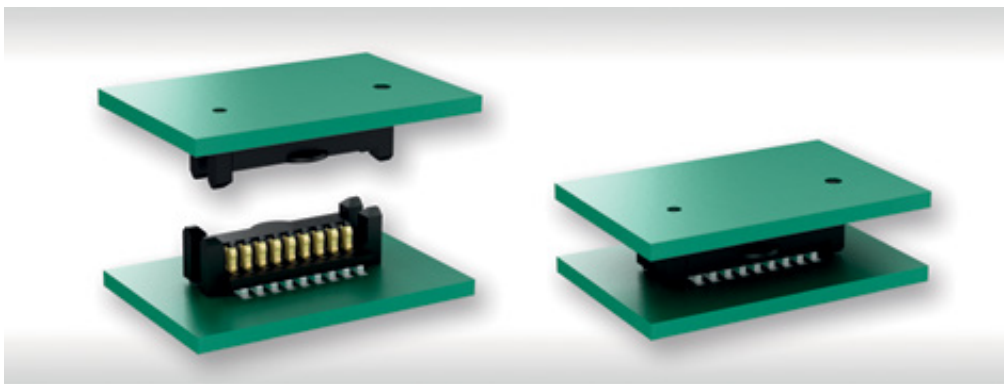

- stacked boards (mezzanine) single row version (3 mm board height)

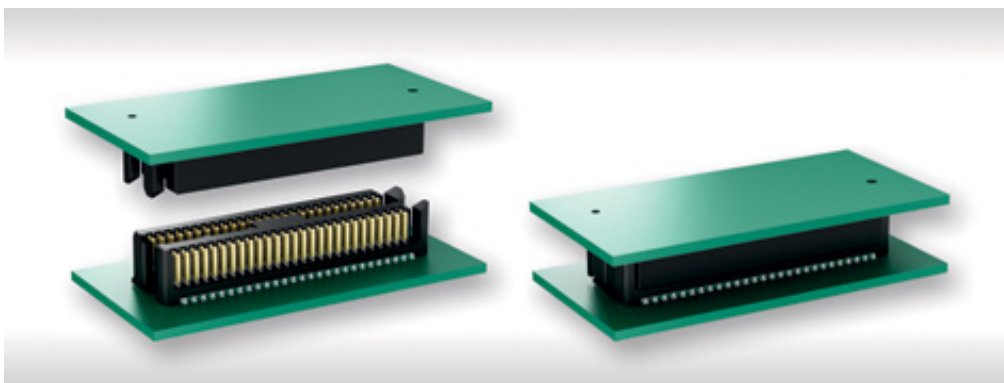

- stacked boards (mezzanine) dual row version (5 mm board height)

ADVANTAGES

Contact Design

- no difference between male and female connector
- contacts are based on a patented contact design; Patent-No.: DE 19 809 881; US 6,379,170
- two contact points for compensation of tolerances

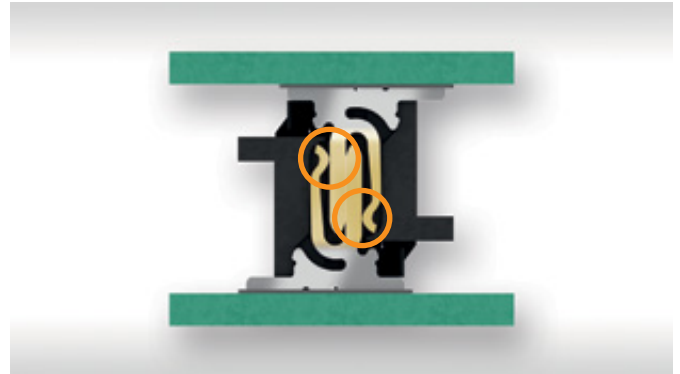

Easy Assembly

- integrated pick and place surface for automatic assembly
- pick and place surface will hinge away when mated the first time (2-row versions)

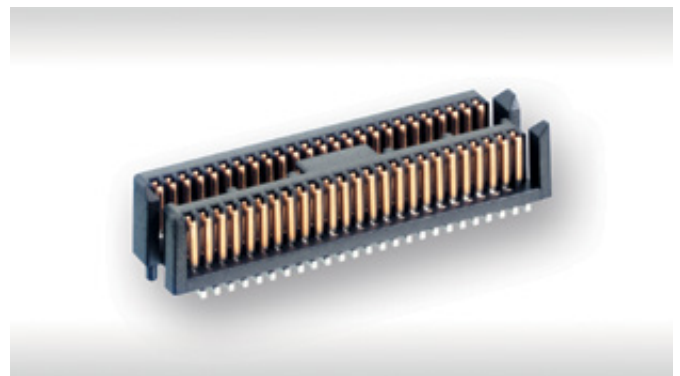

Locating Pegs

- geometrically heterogeneous locating pegs for precise positioning on the circuit board
- enables highly reliable compensation of Printed Circuit Board (PCB) holes for both positive and negative tolerances

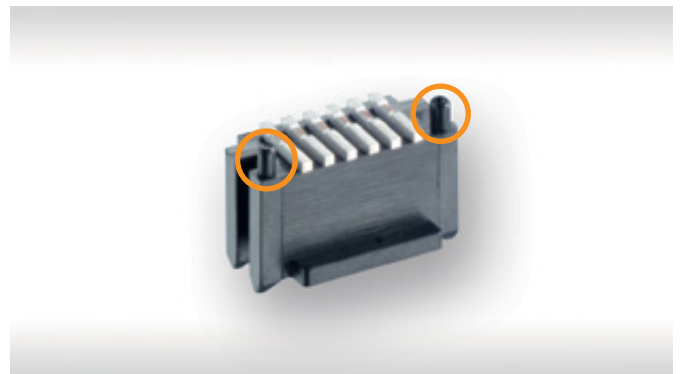

Processing

- tape and reel packaging for transport safe packaging and automatic assembly
- automatic assembly and reflow soldering for efficient processing on modern assembly lines

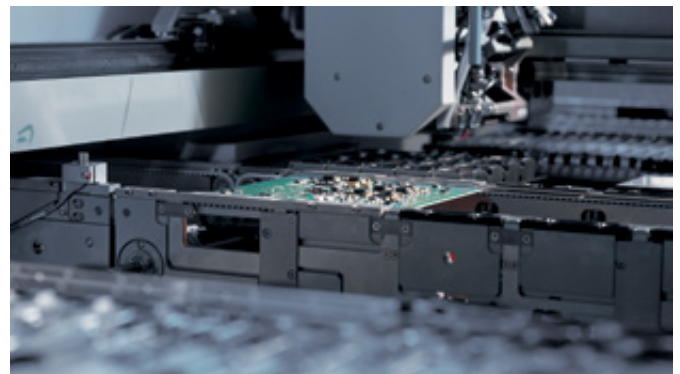

MATING CONDITIONS FOR SINGLE ROW VERSIONS

Allowed Inclination for a more Secure Self-Centering

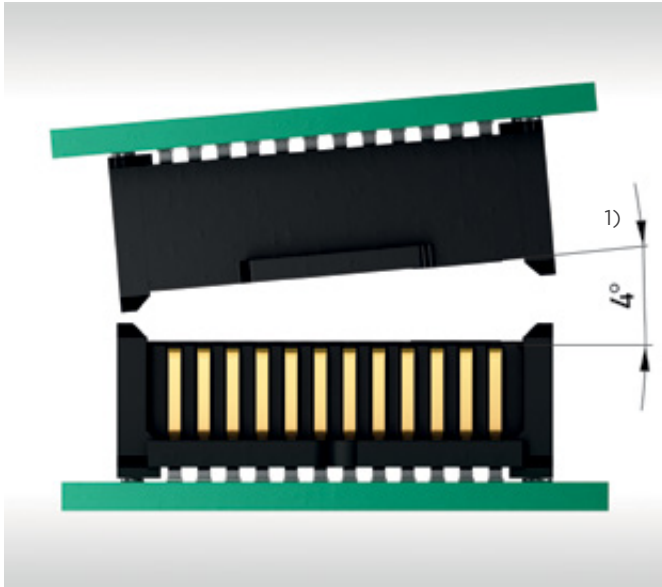

1) depends on No. of Pins and misalignment tolerance

Allowed Misalignment Tolerances for a more Secure Self-Centering

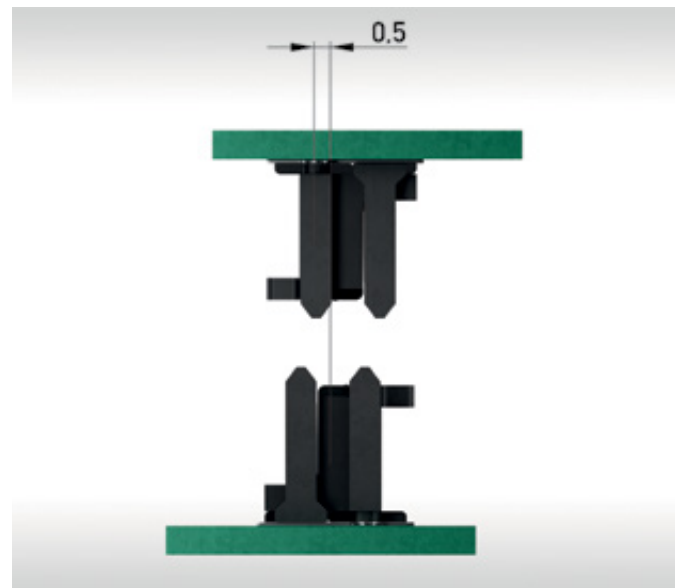
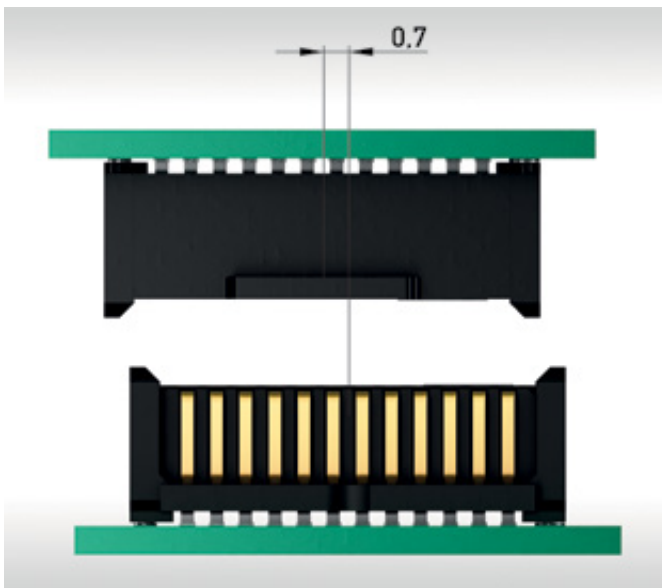

MATING CONDITIONS FOR DUAL ROW VERSIONS

Allowed Inclination for a more Secure Self-Centering

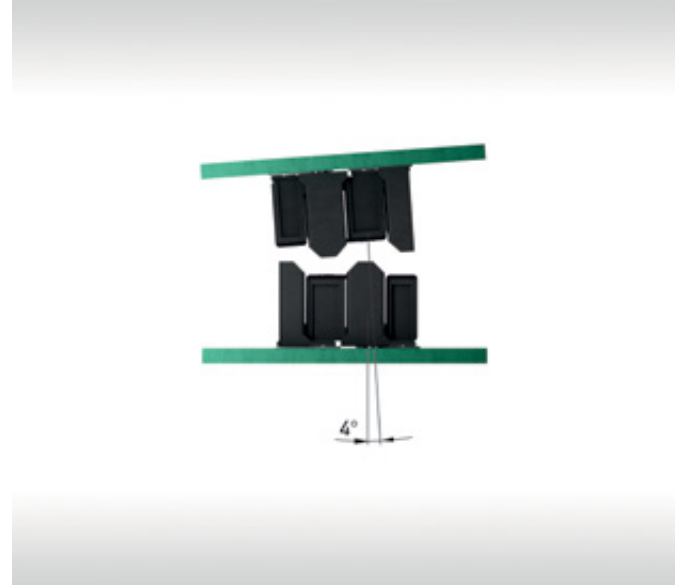
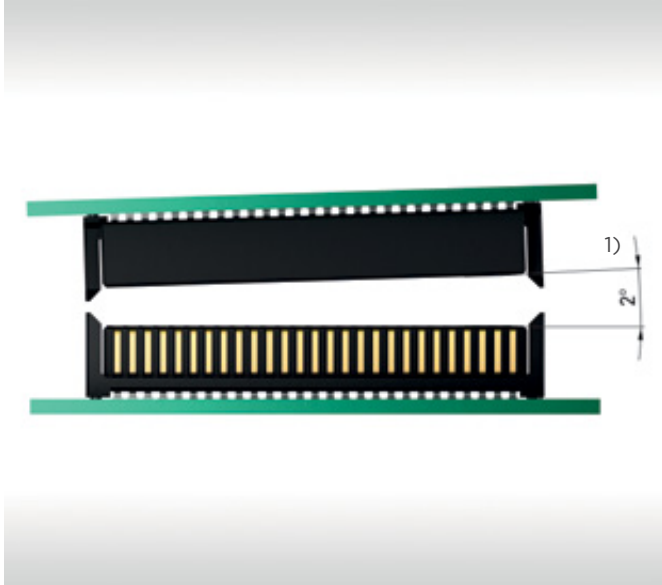

1) depends on No. of Pins and misalignment tolerance

Allowed Misalignment Tolerances for a more Secure Self-Centering

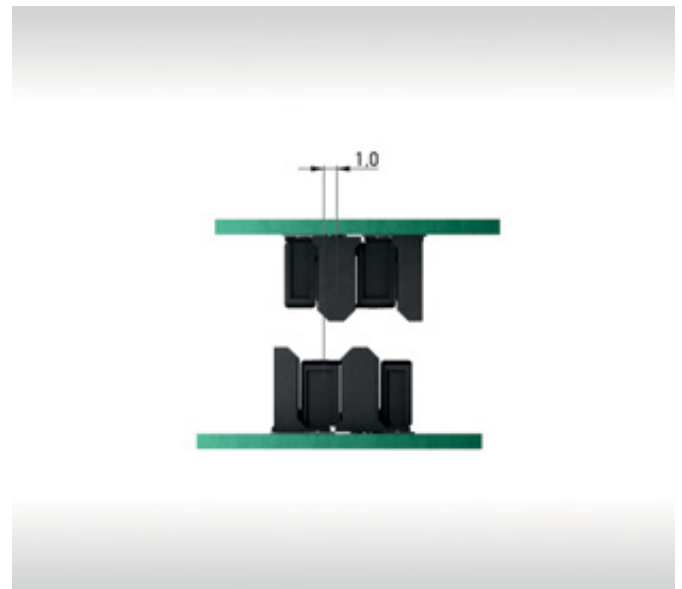
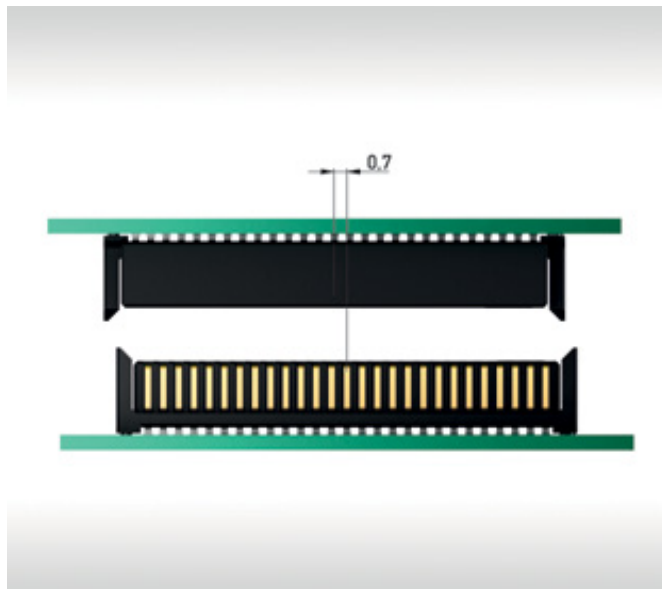

ELECTRICAL AND MECHANICAL CHARACTERISTICS

Technical Data

Description	Standard	Single- and Dual-Row Connectors
Climate category	DIN EN 60068-1 test b	-55 / 125 / 21
Temperature range		-55 / 125 °C
Current rating per contact	IEC60512 test 5b	50-pin version at 20 °C ambient temperature: 1.6 A
Air- and creepage distance		contact - contact min. 0.4 mm
Operating voltage	IEC 60664	<p>The permissible operating voltages depend on the customer application and on the applicable or specified safety requirements.</p> <p>Insulation coordination according to IEC 60664-1 has to be regarded for the complete electrical device. Therefore, the maximum creepage and clearance distances of the mated connectors are specified for consideration as a part of the whole current path. In practice, reductions in creepage or clearance distances may occur due to the conductive pattern of the printed board or the wiring used, and have to be taken into account separately.</p> <p>As a result the creepage and clearance distances for the application may be reduced compared to those of the connector.</p>
Dielectric strength	IEC 60512 test 4a	contact - contact 500 V _{rms}
Contact resistance	IEC 60512 test 2a	< 10 mΩ
Insulation resistance	IEC 60512 test 3a	> 10 ⁴ MΩ
Vibration, sine	IEC 60512 test 6d	10 - 2000 Hz 20 g
Contact disturbance (while vibration test)	IEC 60512 test 2e	< 1 μs
Shock halfsine	IEC 60512 test 6c	50 g 11 ms
Contact disturbance (while shock test)	IEC 60512 test 2e	< 1 μs
Mechanical operation	IEC 60512 test 9a	< 10 mating cycles
Insertion and withdrawal force	IEC 60512 test 13b	3 mm stack height: max. 4 N per contact 5 mm stack height: max. 2 N per contact
Gauge retention force	IEC 60512 test 16e	> 0.15 N
Processing Conditions		
Hand soldering temperature max.	IEC 60068-2-20	3,5 s at 350 °C
Dip soldering temperature max.	IEC 60068-2-20	10 s at 260 °C
Reflow soldering temperature max.	JEDEC J-STD-020	20 - 40 s at 260 °C
Coplanarity		< 0.1 mm

ELECTRICAL AND MECHANICAL CHARACTERISTICS

Technical Data

Description	Standard	Single- and Dual-Row Connectors
Housing Material		
Insulation body		PPA
CTI value	IEC 112	> 600
UL flame rating		UL 94 V-0
UL file plastic material		E171666
Contact Material		
Base material		Cu alloy
Mating area		gold plating
Termination area		Sn
Environment Compatibility		
Recycling		no flame-retardant additives, no toxic additives allow easy recycling

VERTICAL MALE, SINGLE ROW

Product Specification

- pitch 0.8 mm
- SMT process compatible
- two contact points
- one part number for interconnection saving admin and logistic costs
- mated stacking height: 3 mm (wipe length: 0 mm) or 5 mm (wipe length: 1.5 mm)
- anti-magnetic versions available
- for available part numbers please refer to our website



Dimensional Drawings

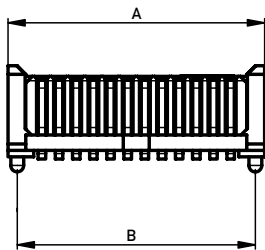

Stacking Height 5 mm

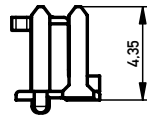

Stacking Height 3 mm

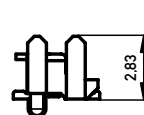

No. of Contacts	A	B
6	7.16	6.30
9	9.56	8.70
10	10.36	9.50
12	11.96	11.10
14	13.56	12.70

All dimensions in mm

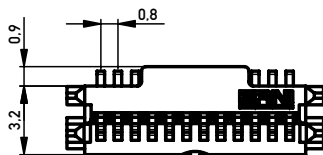

Recommended Layout

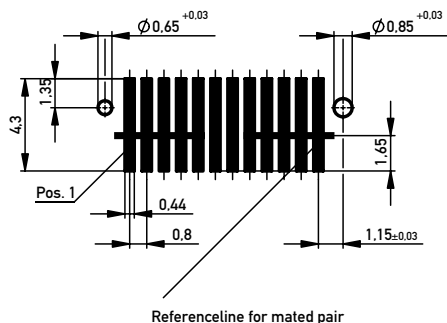

VERTICAL, DUAL ROW

Product Specification

- pitch 0.8 mm
- SMT process compatible
- two contact points
- one part number for interconnection saving admin and logistic costs
- mated stacking height: 5 mm (wipe length: 1.5 mm)
- anti-magnetic versions available
- for available part numbers please refer to our website

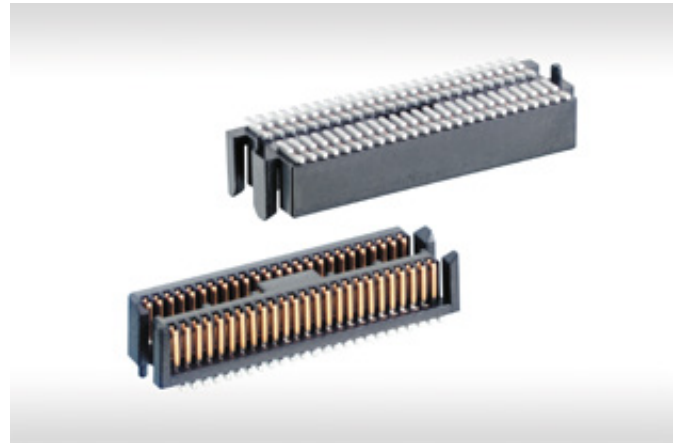

Dimensional Drawings

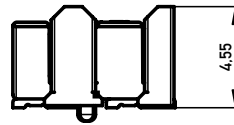
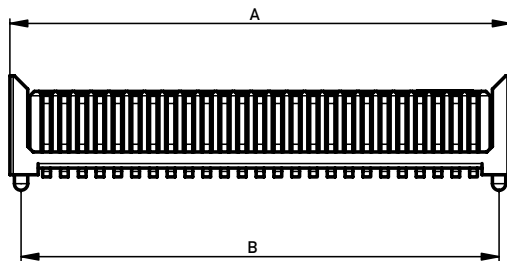

No. of Contacts	A	B
50	22.50	21.50
54	24.10	23.10

All dimensions in mm

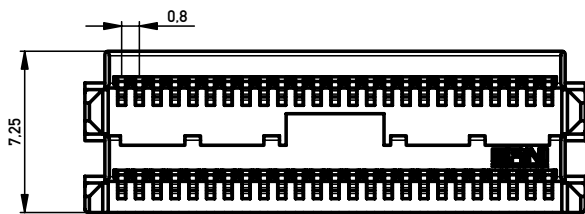

Recommended Layout

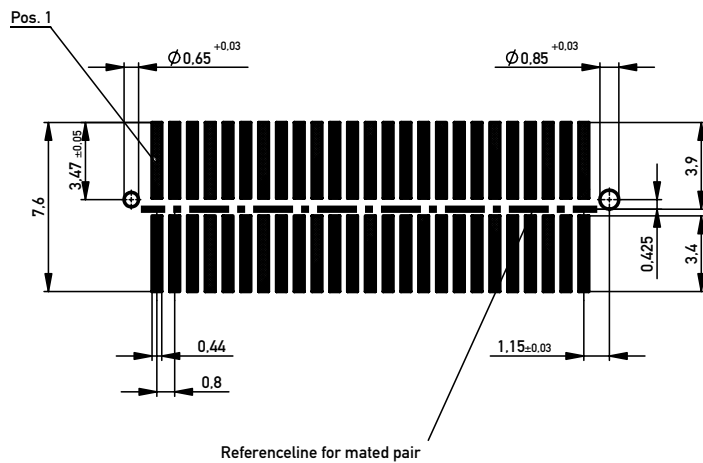

Connect With Us

We make it easy to connect with our experts and are ready to provide the support you need. Visit www.te.com/support to chat with a Product Information Specialist.

te.com

2023 TE Connectivity. All Rights Reserved.

TE Connectivity, TE connectivity (logo), ERNI, MicroStac and Every Connection Counts are trademarks owned or licensed by the TE Connectivity family of companies. All other logos, products and/or company names referred to herein might be trademarks of their respective owners.

The information given herein, including drawings, illustrations and schematics which are intended for illustration purposes only, is believed to be reliable. However, TE Connectivity makes no warranties as to its accuracy or completeness and disclaims any liability in connection with its use. TE Connectivity's obligations shall only be as set forth in TE Connectivity's Standard Terms and Conditions of Sale for this product and in no case will TE Connectivity be liable for any incidental, indirect or consequential damages arising out of the sale, resale, use or misuse of the product. Users of TE Connectivity products should make their own evaluation to determine the suitability of each such product for the specific application.

JS 10/23 Original

CATALOG

TE Connectivity

ERNI Deutschland GmbH
a TE Connectivity Ltd. company
Seestraße 9
73099 Adelberg
Germany

Tel +49 7166 50-0
www.te.com