

MicroSpeed

1.0 mm Connectors

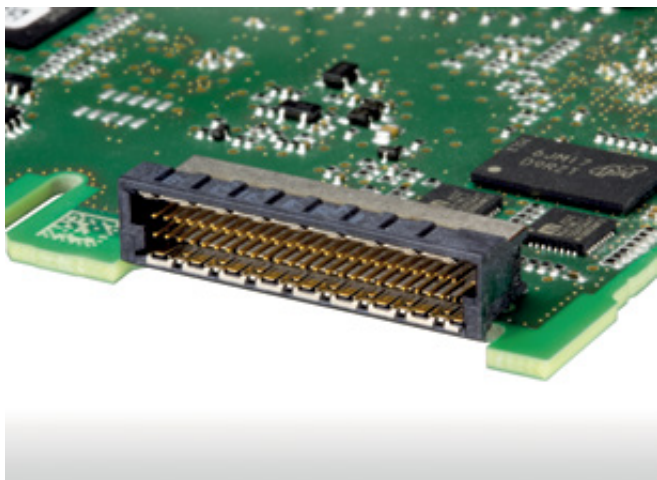
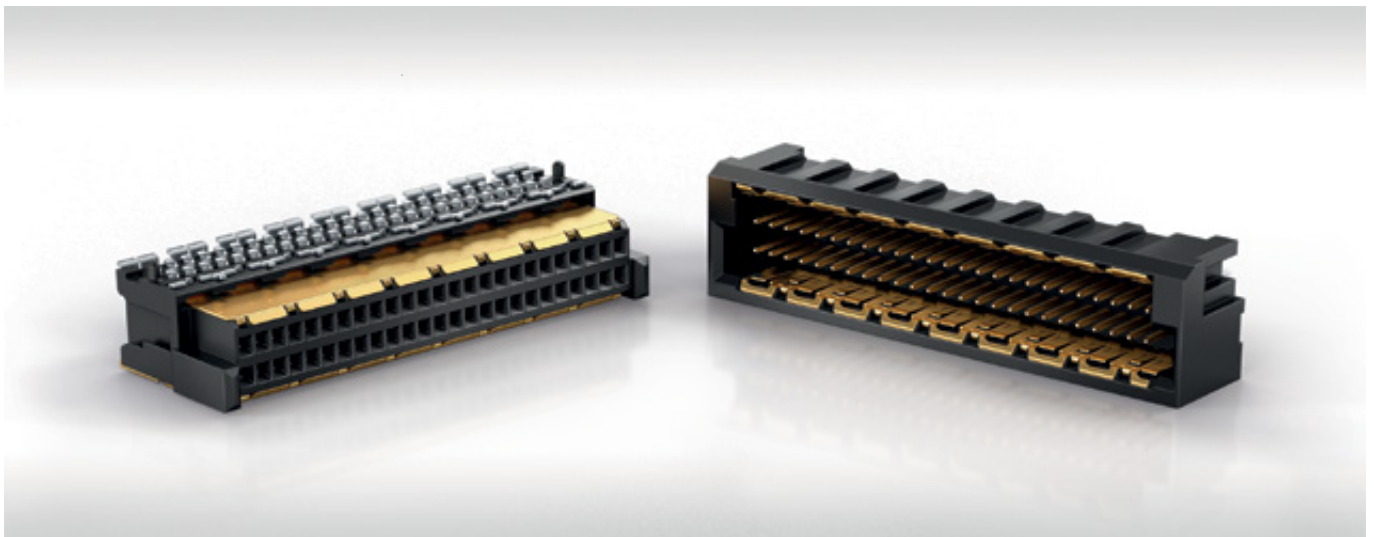

MicroSpeed HIGH-SPEED INTERCONNECT SOLUTIONS

ERNI's MicroSpeed connector family is synonymous with fast data transmission, for high signal quality and for time-tested reliability in permanent application.

The shielded connector family with 1 mm pitch enables high-speed data applications with up to 25 Gbit/s. The connectors are excellent for next generation communication standards like Ethernet 100 Gbps (IEEE 802.3ba), Optical Internetworking Forum (OIF), USB 3.1, etc. Typical applications which will benefit from the new connectors are data communication and telecommunication, high-end computing, medical technology and industrial automation with high speed transmissions and high data volumes.

Electromagnetic compatibility can be significantly improved thanks to the optimized shield concept. The connectors have minimized electromagnetic radiation and very good resistance to interference.

The robust frame design with polarized mating face and the Blind Mate features are decisive aspects for use in industrial environments. The dual-beam female contact provides safer and reliable connection in rough environments and provides a wipe length of 1.5 mm.

MicroSpeed connectors: moving data faster

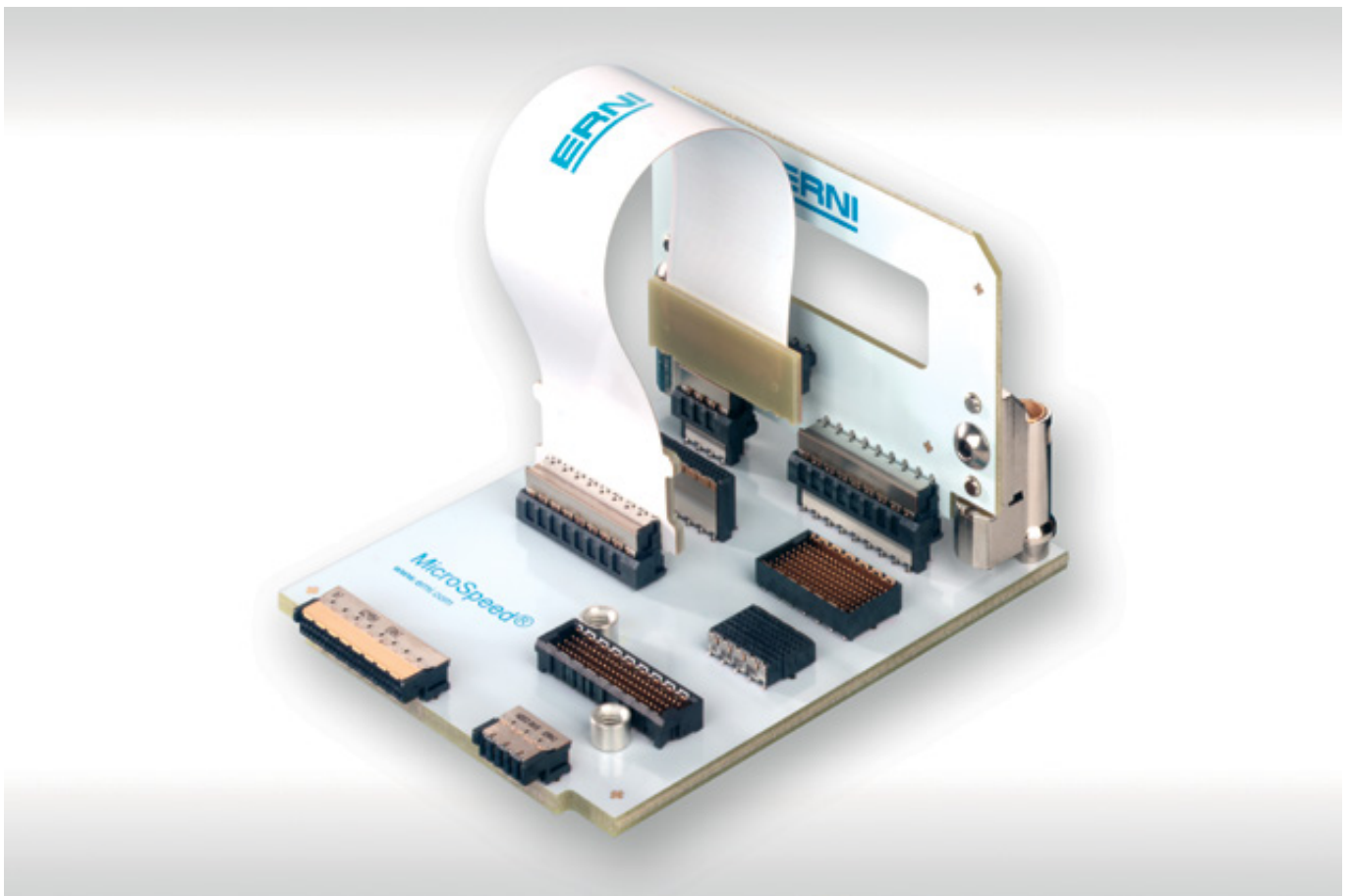

FEATURES

Pitch	1.0 mm
No. of Pins	26, 32, 44 und 50 (2-row), 75 (3-row), 91 and 133 (7-row)
Data rate	up to 25 Gbit/s
Board-to-Board height	5 - 20 mm
Termination technology	Signal contacts: Surface Mount Technology (SMT) Shield contacts: SMT or Through Hole Reflow (THR)
Connectors	2-row versions 3-row versions (MicroSpeed Triple) 7-row versions (Open Pin Field Array)
Variants	Male and female connectors Vertical and right angle Combi-Module Standard (non-Blind Mate) and Blind Mate Electromagnetic Compatibility (EMC) enhanced shielding MicroFlex Flexible Printed Circuit (FPC)

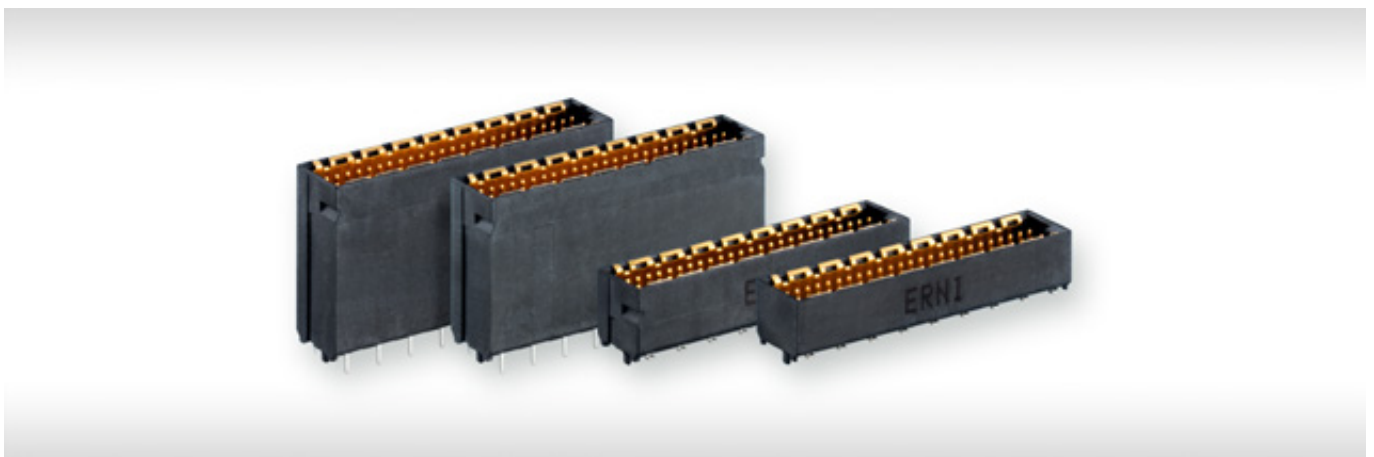

CAPABILITIES

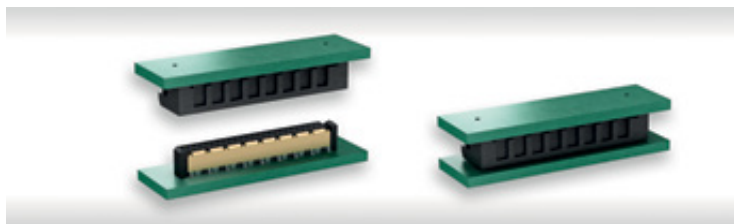

2-row - stacked boards (mezzanine)

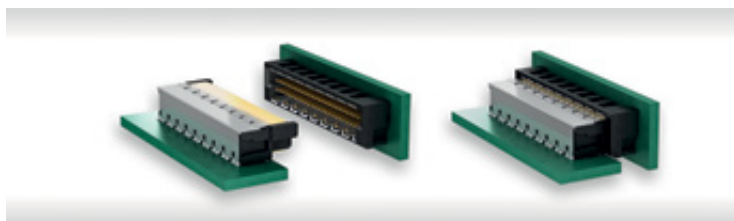

2-row - orthogonal boards

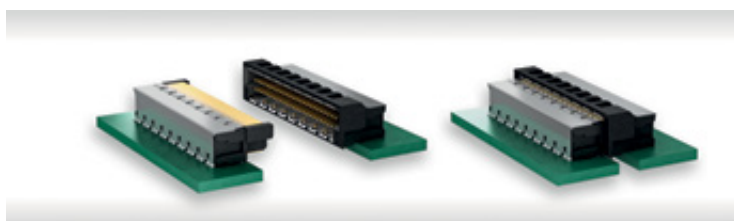

2-row - extender card (coplanar)



MicroFlex FPC

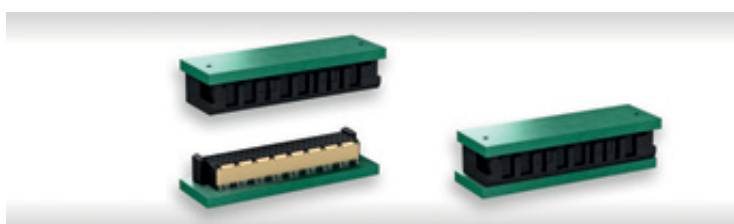

3-row - stacked boards (mezzanine)

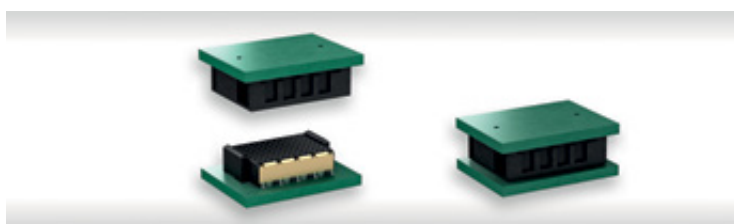

7-row - stacked boards (mezzanine)

VARIOUS TYPES

Mechanical Design & Shielding Concept

For various requirements the MicroSpeed family of products offer excellent solutions:

Robustness / Size of Connector

- standard (very small-sized footprint)
- Blind-Mate (very robust, slightly larger footprint)

Electromagnetic Compatibility (EMC)

- standard shields (very good EMC performance)
- EMC improved shields (outstanding EMC capability; minimized coupling inductance)

Blind Mate Design

- Blind Mate versions feature
 - a distinctive polarization of the mating face
 - extended guides to capture the mating connector
 - increased wall thickness
 - slightly larger footprint
- self-aligning feature, guide the Blind Mate connectors into correct mating position
- designed to provide consistent and reliable mating even in difficult conditions
- robust connectors for harsh environments

Shielding Design

Standard Shielding

- EMC fingers on female

EMC Enhanced Shielding

- EMC fingers on male
- additional SMT shielding tabs for both male and female

Significantly reduced coupling inductance and resulting in excellent electromagnetic compatibility.

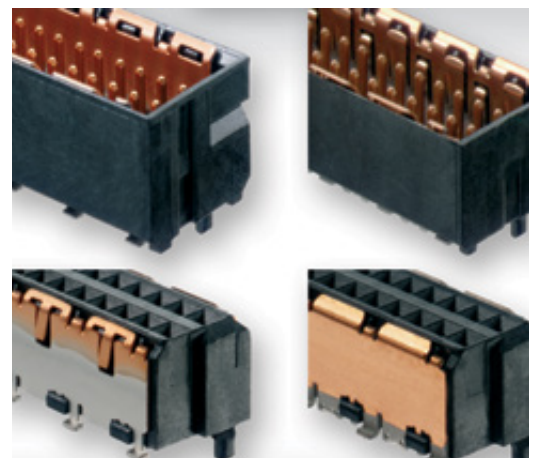
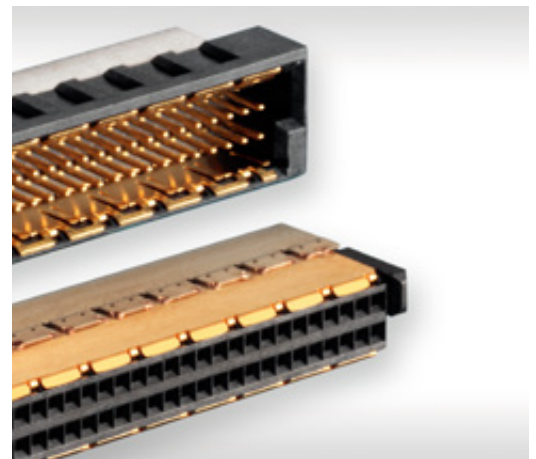
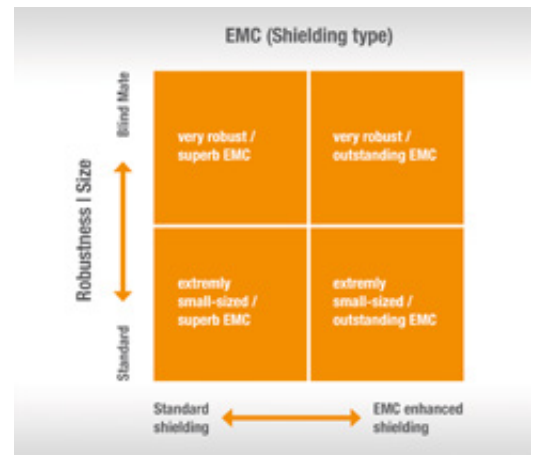

VARIOUS TYPES

High-End EMC Shielding

- The MicroSpeed connectors high-end shielding design provides great performance and highly effective electromagnetic compatibility
 - standard shielding provides an excellent interference resistance against electrostatic discharge (ESD)
 - minimizes the emitted electromagnetic interference (EMI) and significantly reduces interference on sensitive board components
- the EMC enhanced shielding increases the performance by significantly reducing inductive coupling
- advanced communication systems benefit from high signal integrity and more secure data transmission
- optionally, the shields can be used as power planes, providing up to 10 A per shield

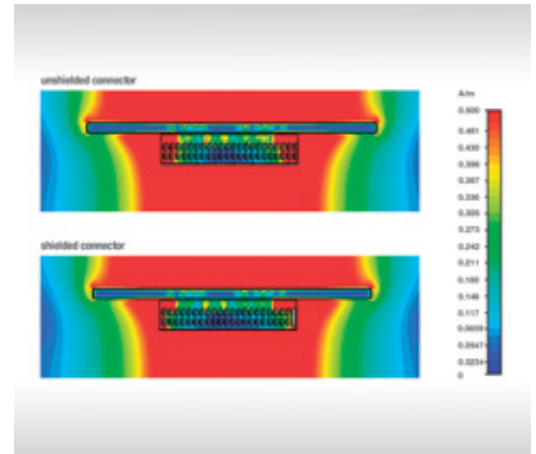

ADVANTAGES

Contact Design and Durability

- High reliability due to dual-beam female contact design:
 - twisted contact tulip (90°)
 - homogeneous, rolled surface provides for more secure contact
 - wide contact surface between mated pair
 - low surface roughness minimizes abrasion
 - low contact resistance
- provides excellent misalignment tolerance/ tolerance compensation
- wipe length 1.5 mm
- durability: > 500 mating cycles
- contact finish: Au plating
- lubricated contacts helps to avoid fretting corrosion



Interface/Mating Face

- shrouded housing protects contacts
- high-temperature resistant materials
- distinctive polarization avoids mismating
- the capture range provides self-alignment and a high misalignment tolerance and inclination
- low-profile narrow housing design provides airflow to promote system cooling



ADVANTAGES

SMT/SMT and SMT/THR Termination

- surface mount connectors (SMT contacts / SMT shielding)
 - double sided board assembly
 - 100% coplanarity of ≤ 0.1 mm leads to excellent soldering results
- optional THR terminals on shielding (SMT contacts / THR shielding)
 - THR shield terminals provide strong mechanical solder joint for demanding industrial applications

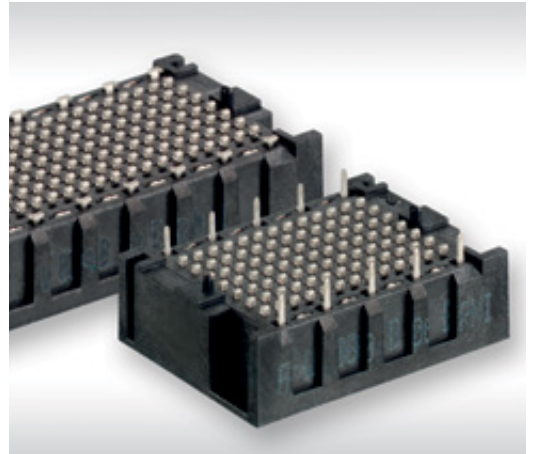

Backside Reflow Soldering

The MicroSpeed connectors meet high efficient board processing:

- capable of backside reflow soldering vertical low profile male & female SMT versions

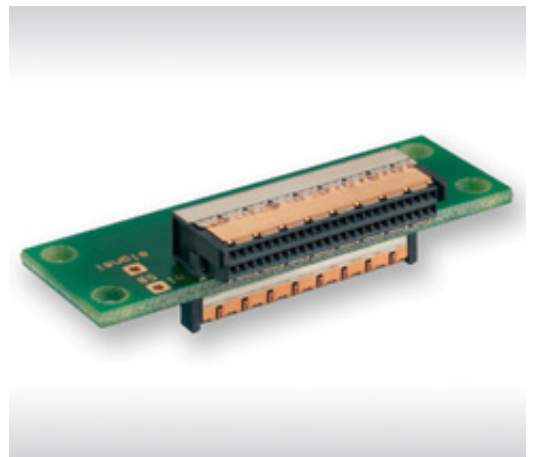

MicroFlex FPC

High-speed connections using multi-layer rigid-flexible boards, e.g.

- two-layer FPC
- high-speed data 25 Gbit/s
- 20 differential pairs
- 500 mm length
- MicroSpeed open pin field array, 133 pin
- test equipment for 100 Gig optical network transmission system

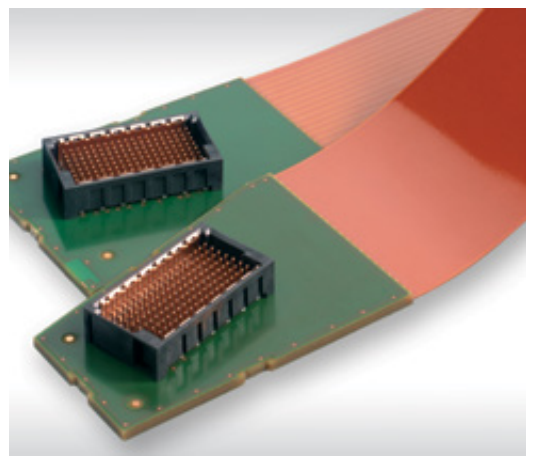

ADVANTAGES

Pick & Place Pad

- pick and place pad for vacuum pick-up nozzles provided for straight connectors
- high-temperature plastic to resist reflow solder temperatures
- right angled versions are commonly picked-up at the smooth shield surface

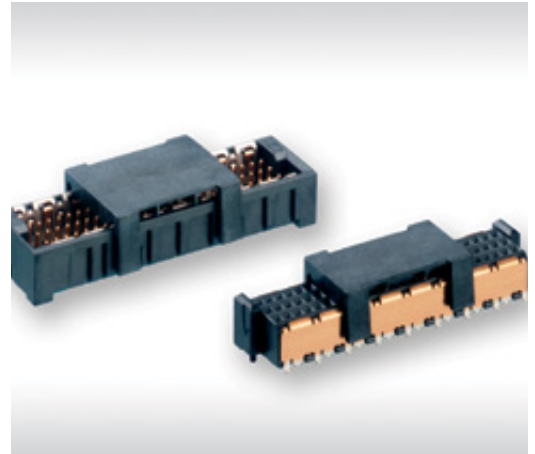

HIGH FREQUENCY CHARACTERISTICS

Performance

Next-generation platforms demand optimal signal integrity performance when routing high-speed signals. Maintaining proper impedance while minimizing discontinuities can be a challenge. Also unwanted noise from coupling of nearby signal lines may result in distortion of the desired signal.

- MicroSpeed family of products combines great high-speed performance with excellent signal integrity
- based on experience, the best performance is achieved at shorter stack heights as it results in shorter period of time for reflections and undesired coupling

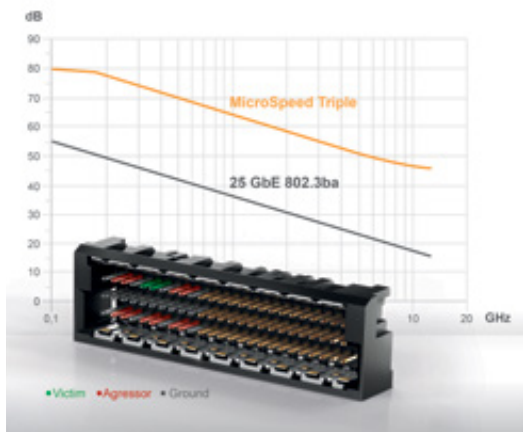

High-Speed Connector Rating

Insertion loss is a performance feature for signal integrity and high-speed characterization as it indicates the loss of power in a transmission channel. MicroSpeed high-speed connector rating is based on 0.5 dB insertion loss (IL).

- performance 25 Gbit/s at 0.5dB IL / 12.5 GHz
- meets 100 Gigabit Ethernet standard (IEEE 802.3ba; 25Gbps per channel)
- up to 42 differential IOs for 25+Gbit/s high-speed rating
- low inductance to ground

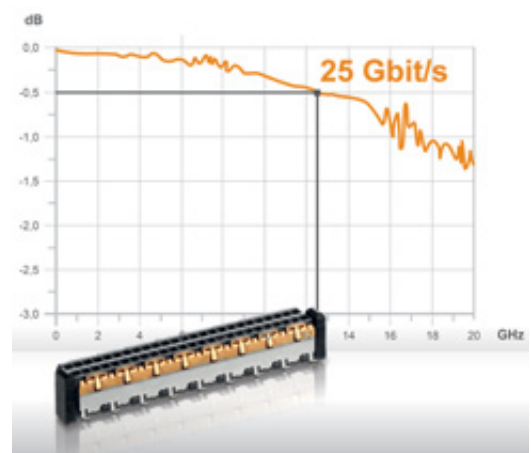

HIGH FREQUENCY CHARACTERISTICS

Signal Integrity

MicroSpeed connectors and Open Pin Field Arrays offer maximum grounding and routing flexibility for transversal, longitudinal or meshed pin assignments.

- various signal-to-ground patterns meet the individual crosstalk requirements (NEXT, FEXT) and hence maintain signal integrity
- the MicroSpeed Triple connectors support crosstalk reduction of up to 90% for certain patterns.



Controlled Impedance

- impedance matched connectors designed to minimize impedance mismatch
- for single-ended (50 Ω) or differential pair (100 Ω) signaling typ

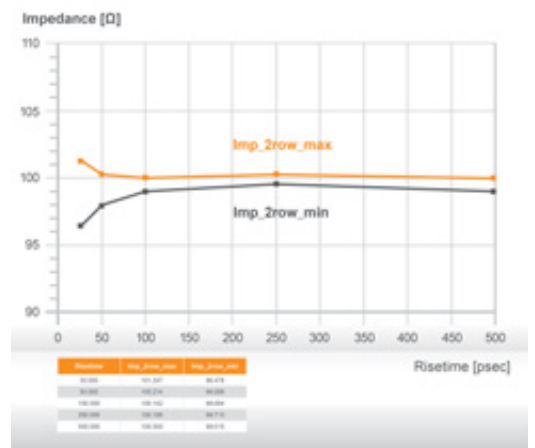

PROCESSING

Tape and Reel Packaging

- transport safe packaging
- for automatic assembly



Automatic Assembly and Reflow Soldering

- for efficient processing on modern assembly lines

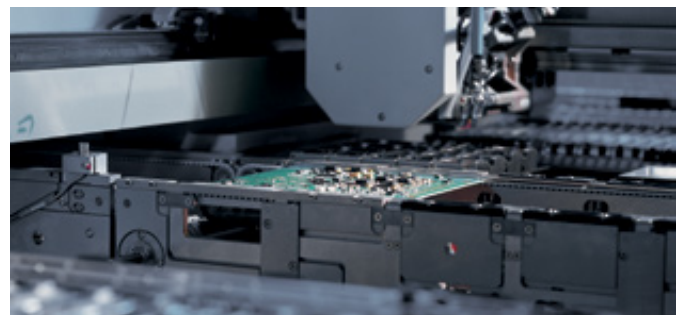

MATING CONDITIONS

Wipe Length (50 pin Blind Mate version)

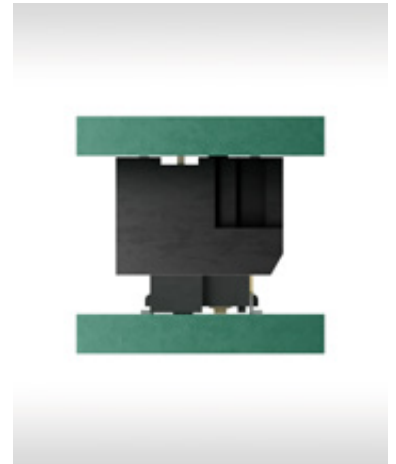
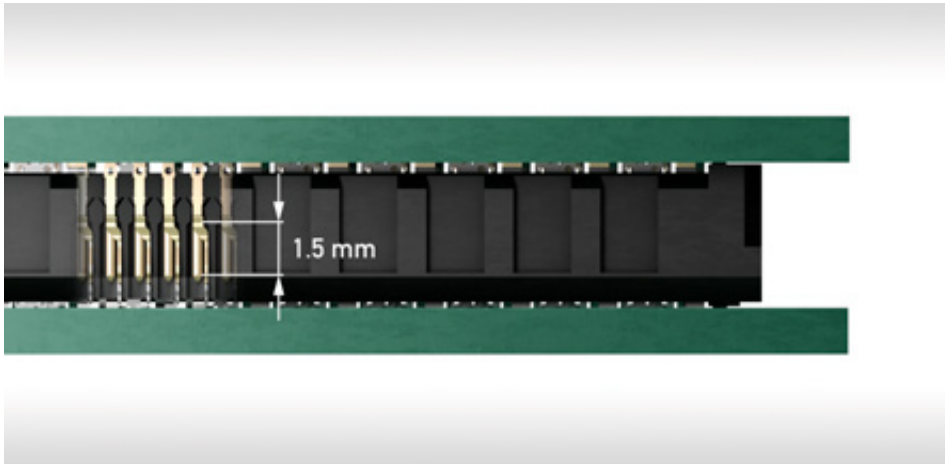

Allowed Inclination for Secure Self-Centering (50 pin Blind Mate version)

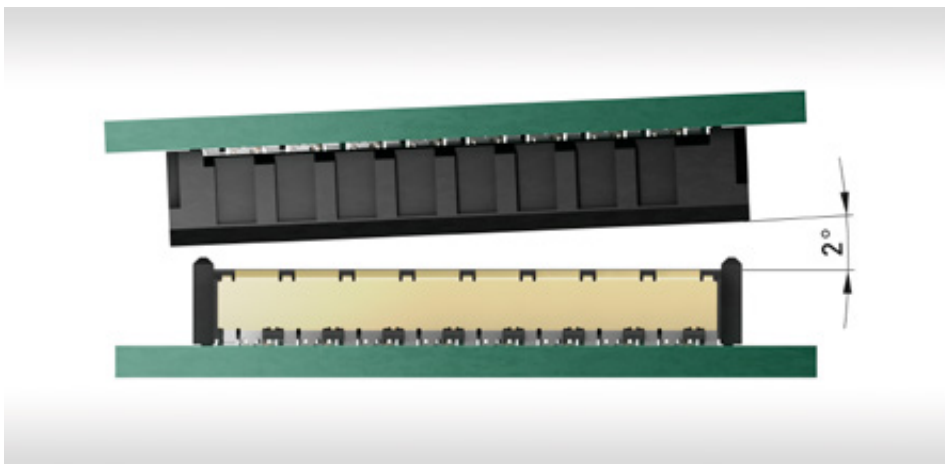

Allowed misalignment for Secure Self-Centering (50 pin Blind Mate version)

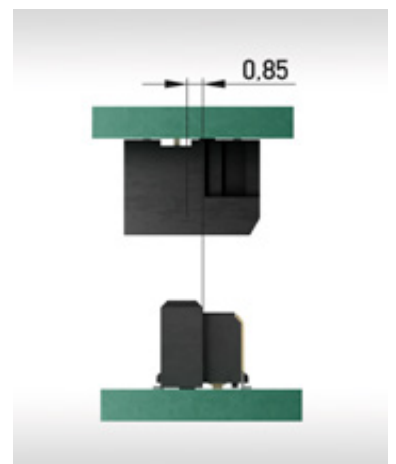
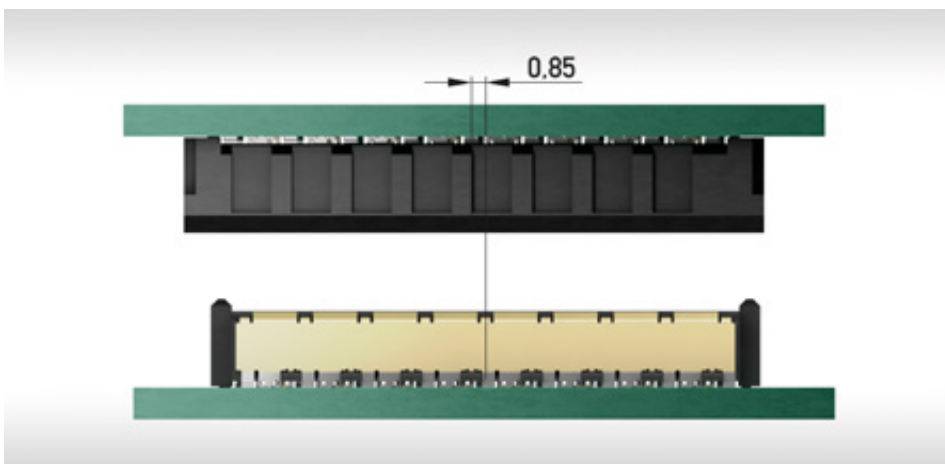

BOARD-TO-BOARD HEIGHT

Flexible Board Stacking

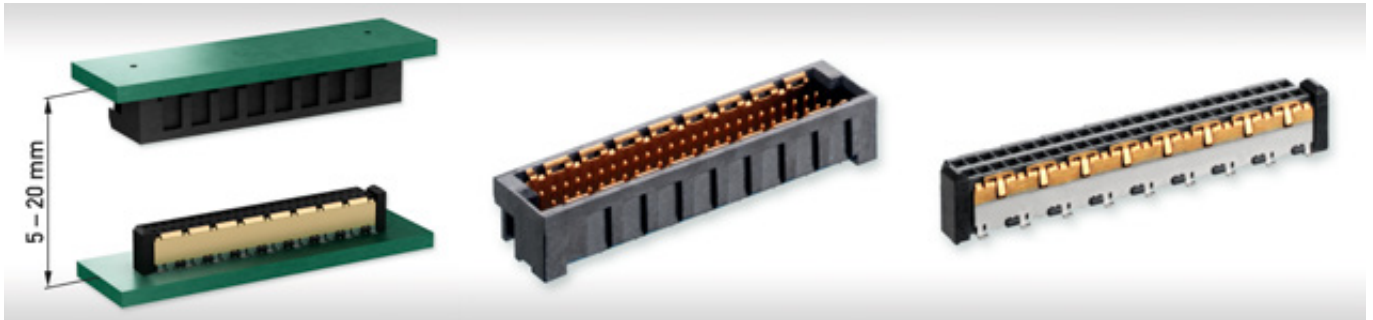

Board-to-Board Height	Male Stacking Height	Female Stacking Height
5 - 6 mm	1 mm	4 mm
6 - 7mm	2 mm	4 mm
7 - 8 mm	1 mm	6 mm
8 - 9 mm	2 mm	6 mm
9 - 10 mm	1 mm	8 mm
10 - 11 mm	2 mm	8 mm
11 - 12 mm	1 mm	10 mm
12 - 13 mm	2 mm	10 mm
13 - 14 mm	9 mm	4 mm
14 - 15 mm	10 mm	4 mm
15 - 16 mm	9 mm	6 mm
16 - 17 mm	10 mm	6 mm
17 - 18 mm	9 mm	8 mm
18 - 19 mm	10 mm	8 mm
19 - 20 mm	9 mm	10 mm
20 - 21 mm	10 mm	10 mm

ELECTRICAL AND MECHANICAL CHARACTERISTICS

Technical Data

Description	Standard	Male and Female Connectors
Climate category	DIN EN 60068-1 test b	55 / 125 / 56
Temperature range		-55 / 125 °C
Current rating per contact	IEC60512 test 5b	ca. 1 A signal contacts / 10 A per shield
Air- and creepage (min.)		contact - contact 0.5 mm
Operating voltage	IEC 60664-1	The permissible operating voltages depends on the customer application and on the applicable or specified safety requirements. Insulation coordination according to IEC 60664-1 has to be regarded for the complete electrical device. Therefore, the maximum creepage and clearance distances of the mated connectors are specified for consideration as a part of the whole current path. In practice, reductions in creepage or clearance distances may occur due to the conductive pattern of the printed board or the wiring used, and have to be taken into account separately. As a result the creepage and clearance distances for the application may be reduced compared to those of the connector.
Dielectric strength	IEC 60512 test 4a	contact - contact 500 V _{rms} contact - ground 500 V _{rms}
Contact resistant	IEC 60512 test 2a	< 25 mΩ to < 50 mΩ (depnds on stacking height)
Insulation resistant	IEC 60512 test 3a	> 10 ⁴ MΩ
Vibration, sine	IEC 60512 test 6d	10 - 2000 Hz 20 g
Contact disturbance (while vibration test)	IEC 60512 test 2e	< 1 μs
Shock, halfsine	IEC 60512 test 6c	50 g 11 ms
Contact disturbance (while shock test)	IEC 60512 test 2e	< 1 μs
Mechanical Operation	IEC 60512 test 9a	500 mating cycles
Insertion and withdrawal force	IEC 60512 test 13b	max. 0.5 N per contact
Gauge retention force	IEC 60512 test 16e	> 0.1 N

ELECTRICAL AND MECHANICAL CHARACTERISTICS

Technical Data

Description	Standard	Male and Female Connectors
Signal Transmission Data		
Data rate		up to 25 Gbit/s
Multiline crosstalk		< 0.5% at 50 ps (10-90%)
Differential impedance		100 Ω
Single-ended impedance		50 Ω
Processing Conditions		
Reflow soldering temperature max.	JEDEC J-STD-020	20 - 40 s at 260 °C
Coplanarity		< 0.1 mm
Housing Material		
Insulation body		LCP
CTI value	IEC 112	175
UL flame rating	UL 94	V-0
UL file plastic material		E83005
MSL	JEDEC J-STD-020	Level 1
Contact Material		
Base material		Cu alloy
Mating area		Gold plating
Termination area		Sn
Environment Compatibility		
Recycling		no flame-retardant additives, no toxic additives allow easy recycling
Product Approval		
UL/CSA		E84703

STANDARD EMC ENHANCED, RIGHT ANGLE FEMALE

Product Specification

- right angle, 2-row
- 26, 50 pins
- data rates up to 25 Gbit/s
- EMC enhanced shielding
- shield contacts available in SMT or THR
- tape and reel packaging
- for available part numbers please refer to our website



Dimensional Drawings | 50 Pin Version

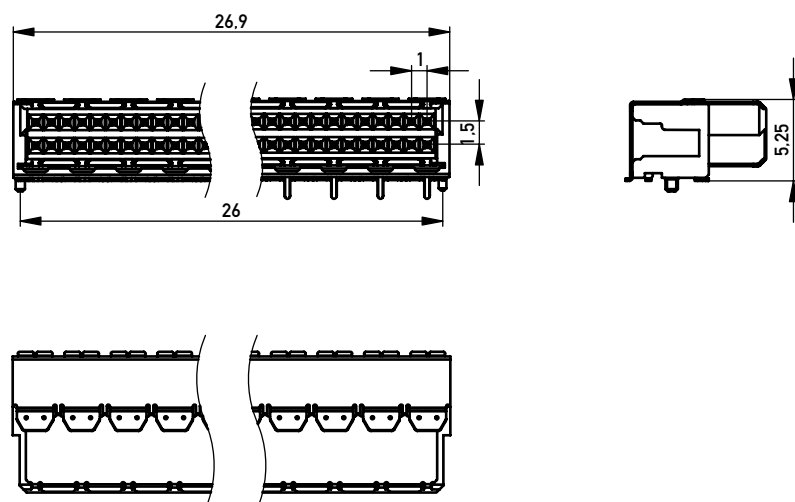

Recommended Layout

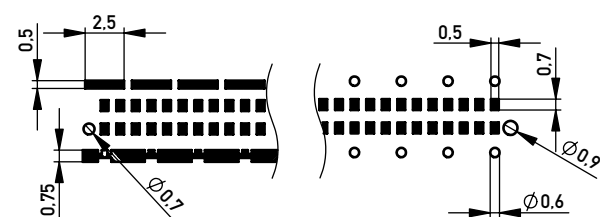

BLIND MATE EMC ENHANCED, RIGHT ANGLE FEMALE

Product Specification

- right angle, 2-row
- 32, 44, 50 pins
- Blind Mate design
- data rates up to 25 Gbit/s
- EMC enhanced shielding
- shield contacts available in SMT or THR
- tape and reel packaging
- for available part numbers please refer to our website



Dimensional Drawings | 50 Pin Version

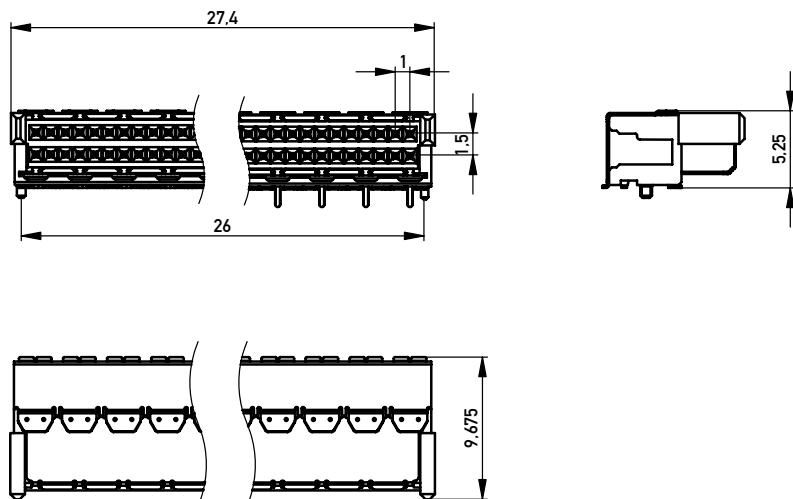

Recommended Layout

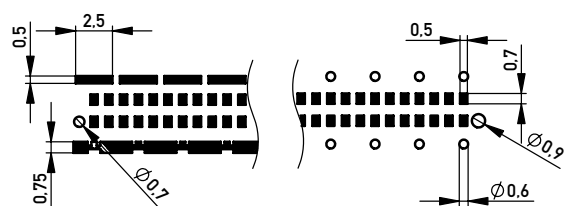

STANDARD, VERTICAL FEMALE

Product Specification

- vertical, 2-row
- 50 pins
- data rates up to 25 Gbit/s
- standard shielding
- shield contacts available in SMT or THR
- heights: 4, 6, 8, 10 mm
- tape and reel packaging
- for available part numbers please refer to our website



Dimensional Drawings | 50 Pin Version

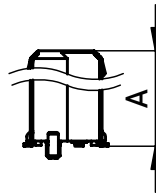
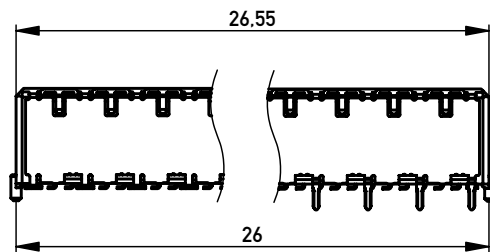

Stacking Height	A
4 mm	3.80
6 mm	5.80
8 mm	7.80
10 mm	9.80

All dimensions in mm

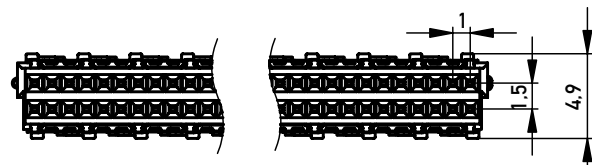

Recommended Layout

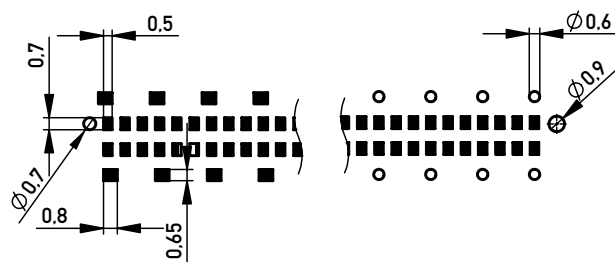

BLIND MATE, VERTICAL FEMALE

Product Specification

- vertical, 2-row
- 50 pins
- Blind Mate design
- data rates up to 25 Gbit/s
- standard shielding
- shield contacts available in SMT or THR
- heights: 4, 6, 8, 10 mm
- tape and reel packaging
- for available part numbers please refer to our website

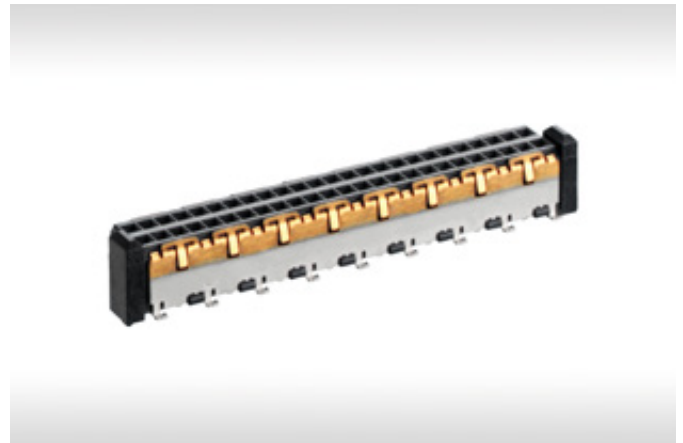

Dimensional Drawings | 50 Pin Version

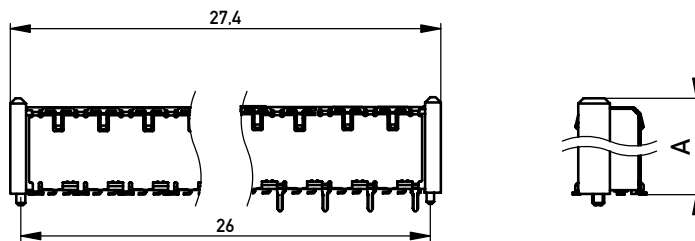

Stacking Height	A
4 mm	4.40
6 mm	6.40
8 mm	8.40
10 mm	10.40

All dimensions in mm

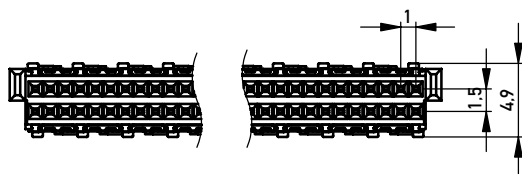

Recommended Layout

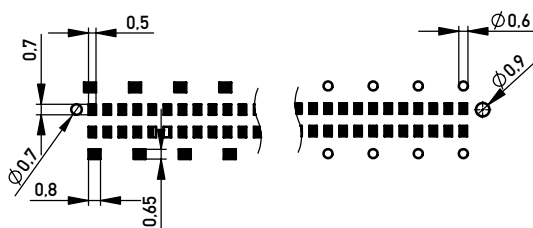

STANDARD EMC ENHANCED, VERTICAL FEMALE

Product Specification

- vertical, 2-row
- 26, 50 pins
- data rates up to 25 Gbit/s
- EMC enhanced shielding
- shield contacts available in SMT
- height: 4 mm
- tape and reel packaging
- for available part numbers please refer to our website



Dimensional Drawings | 50 Pin Version

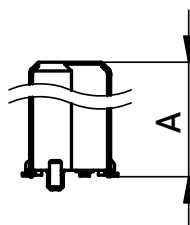
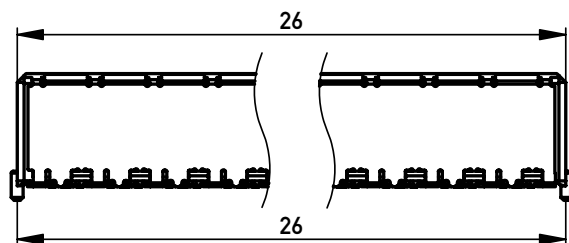

Stacking Height	A
4 mm	3.80

All dimensions in mm

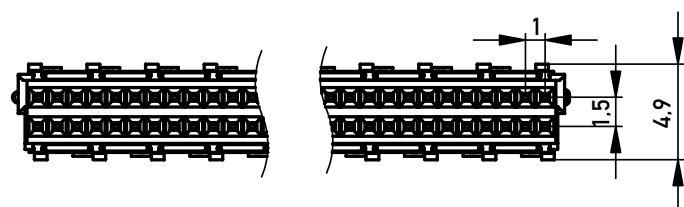

Recommended Layout

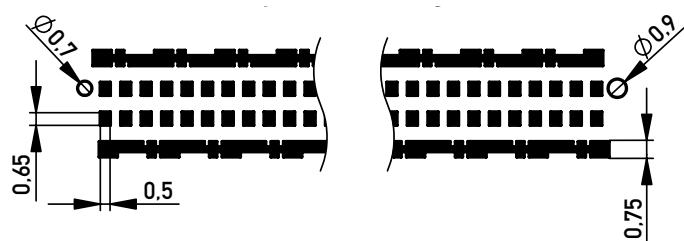

BLIND MATE EMC ENHANCED, VERTICAL FEMALE

Product Specification

- vertical, 2-row
- 32, 50 pins
- Blind Mate design
- data rates up to 25 Gbit/s
- EMC enhanced shielding
- shield contacts available in SMT
- height: 4 mm
- tape and reel packaging
- for available part numbers please refer to our website



Dimensional Drawings | 50 Pin Version

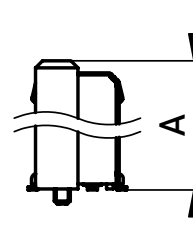
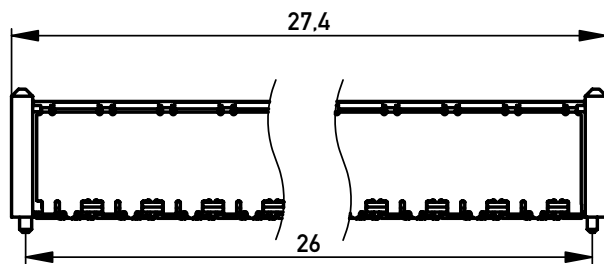

Stacking Height	A
4 mm	4.40

All dimensions in mm

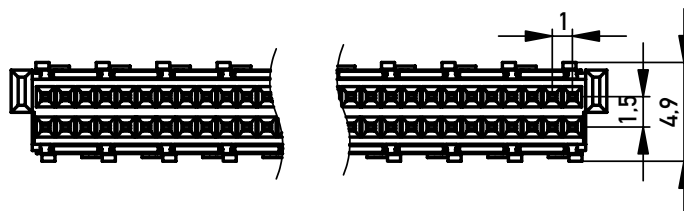

Recommended Layout

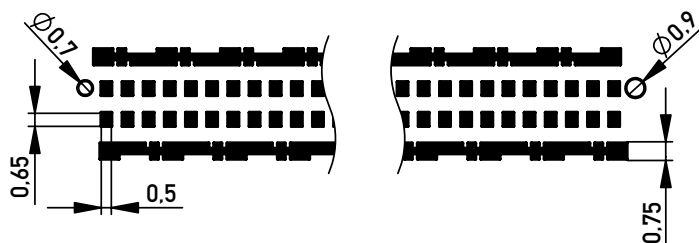

STANDARD EMC ENHANCED, RIGHT ANGLE MALE

Product Specification

- right angle, 2-row
- 26, 50 pins
- data rates up to 25 GBit/s
- EMC enhanced shielding
- shield contacts available in SMT or THR
- tape and reel packaging
- for available part numbers please refer to our website

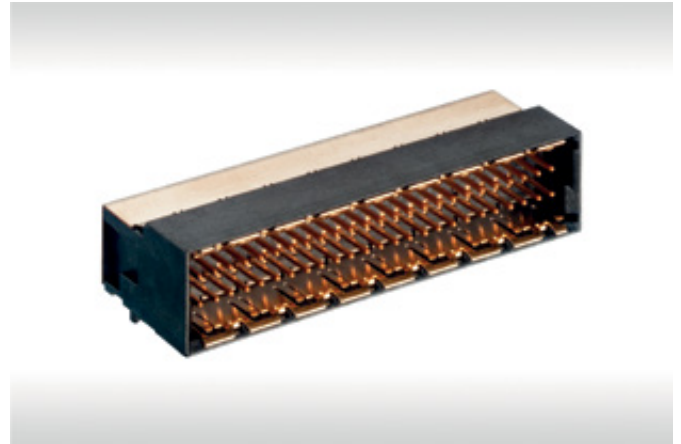

Dimensional Drawings | 50 Pin Version

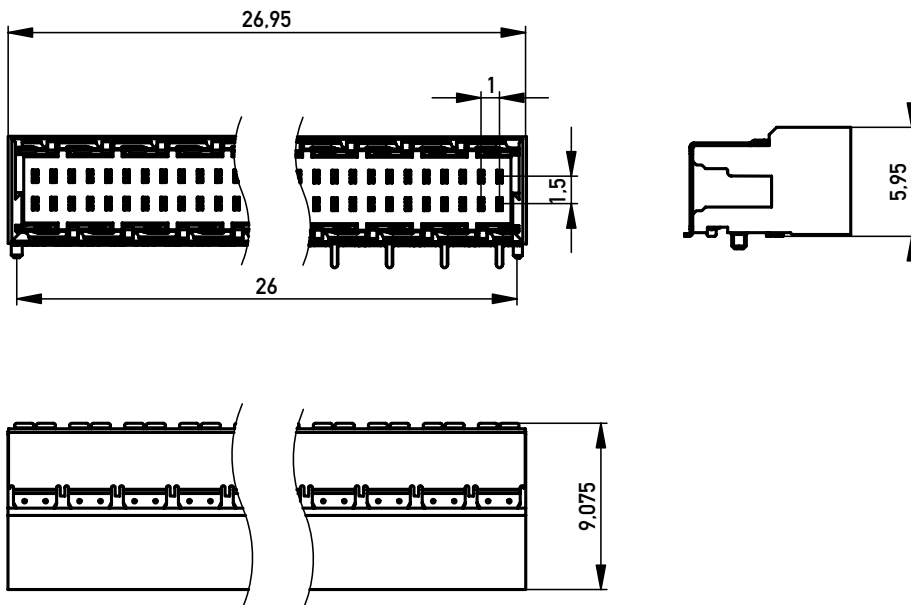

Recommended Layout

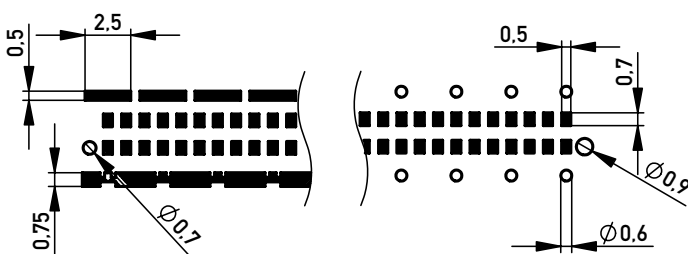

BLIND MATE EMC ENHANCED, RIGHT ANGLE MALE

Product Specification

- right angle, 2-row
- 32, 50 pins
- Blind Mate design
- data rates up to 25 GBit/s
- EMC enhanced shielding
- shield contacts available in SMT or THR
- tape and reel packaging
- for available part numbers please refer to our website

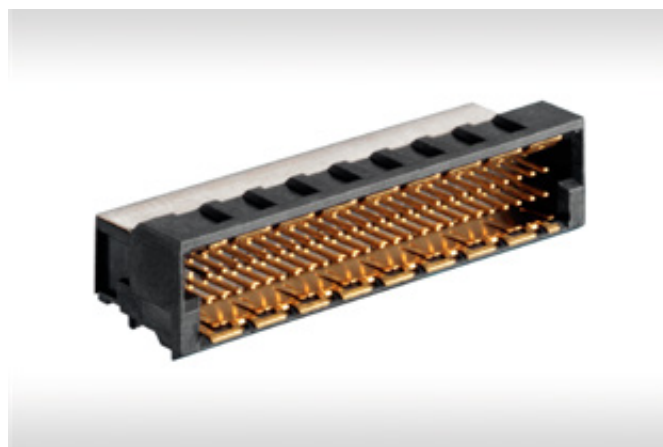

Dimensional Drawings | 50 Pin Version

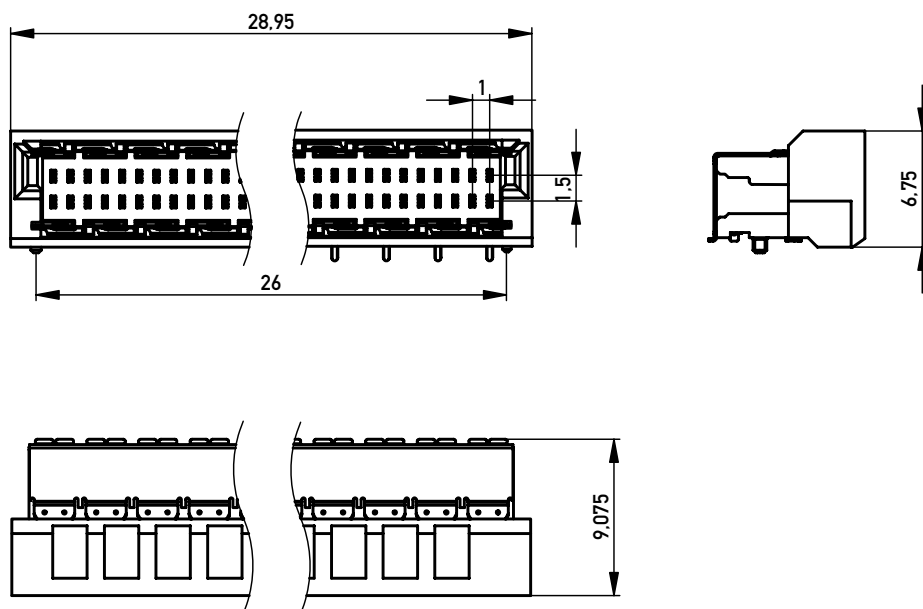

Recommended Layout

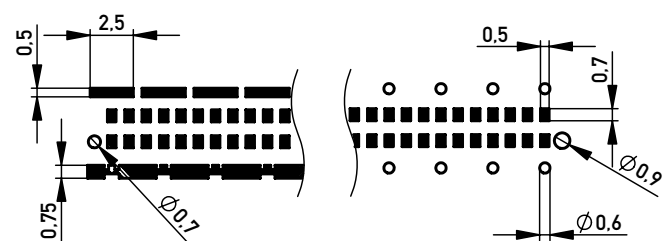

STANDARD, VERTICAL MALE

Product Specification

- vertical, 2-row
- 50 pins
- data rates up to 25 Gbit/s
- standard shielding
- shield contacts available in SMT or THR
- heights: 1, 2, 9, 10 mm
- tape and reel packaging
- for available part numbers please refer to our website



Dimensional Drawings | 50 Pin Version

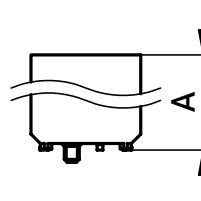
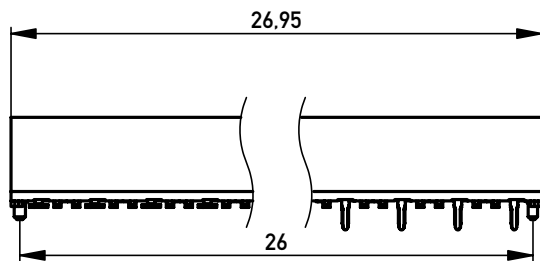

Stacking Height	A
1 mm	4.80
2 mm	5.80
9 mm	12.80
10 mm	13.80

All dimensions in mm

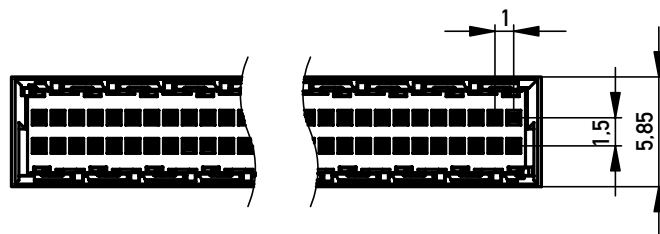

Recommended Layout

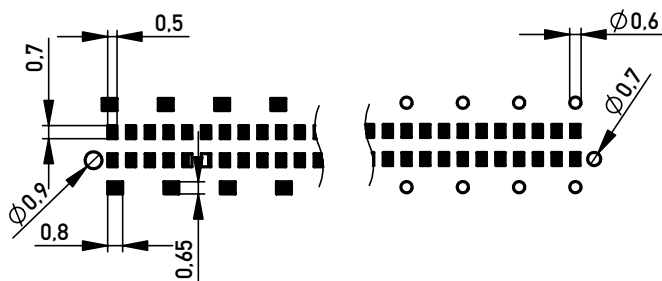

BLIND MATE, VERTICAL MALE

Product Specification

- vertical, 2-row
- 50 pins
- Blind Mate design
- data rates up to 25 Gbit/s
- standard shielding
- shield contacts available in SMT or THR
- heights: 1, 2, 9, 10 mm
- tape and reel packaging
- for available part numbers please refer to our website



Dimensional Drawings | 50 Pin Version

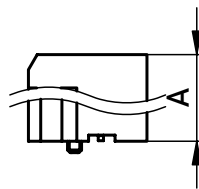
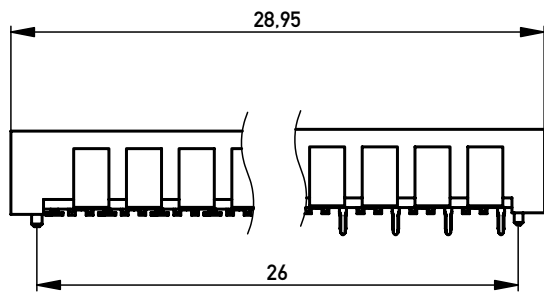

Stacking Height	A
1 mm	4.80
2 mm	5.80
9 mm	12.80
10 mm	13.80

All dimensions in mm

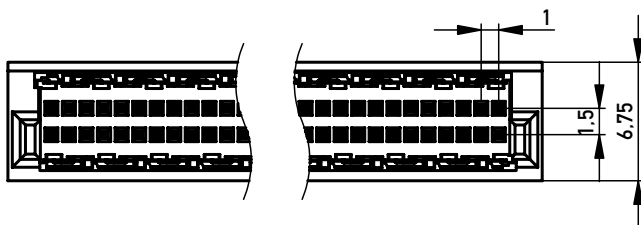

Recommended Layout

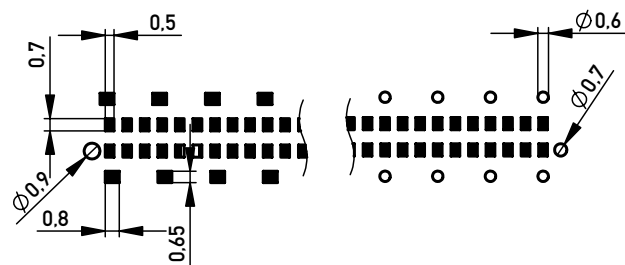

STANDARD EMC ENHANCED, VERTICAL MALE

Product Specification

- vertical, 2-row
- 26, 50 pins
- data rates up to 25 Gbit/s
- EMC enhanced shielding
- shield contacts available in SMT
- height: 1 mm
- tape and reel packaging
- for available part numbers please refer to our website



Dimensional Drawings | 50 Pin Version

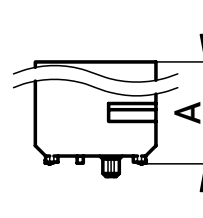
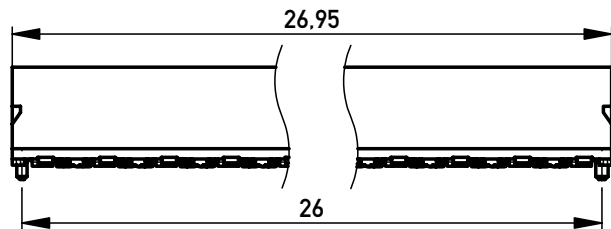

Stacking Height	A
1 mm	4.80

All dimensions in mm

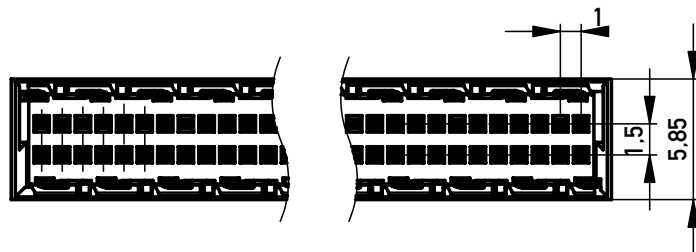

Recommended Layout

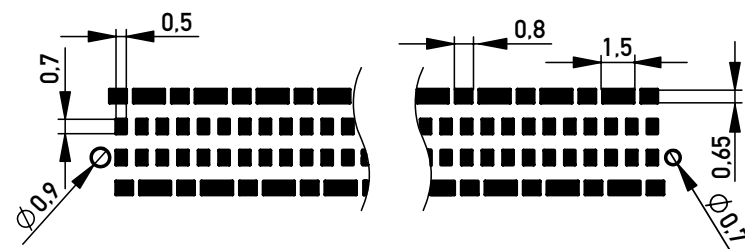

BLIND MATE EMC ENHANCED, VERTICAL MALE

Product Specification

- vertical, 2-row
- 32, 44, 50 pins
- Blind Mate design
- data rates up to 25 Gbit/s
- EMC enhanced shielding
- shield contacts available in SMT
- height: 1, 10 mm
- tape and reel packaging
- for available part numbers please refer to our website



Dimensional Drawings | 50 Pin Version

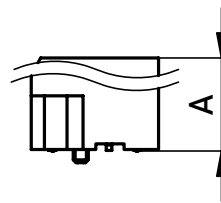
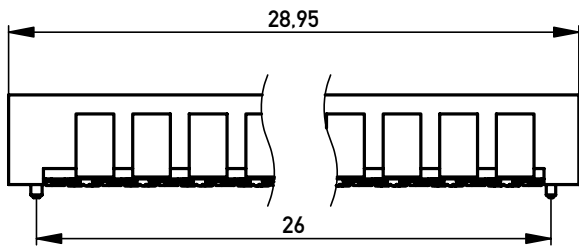

Stacking Height	A
1 mm	4.80

All dimensions in mm

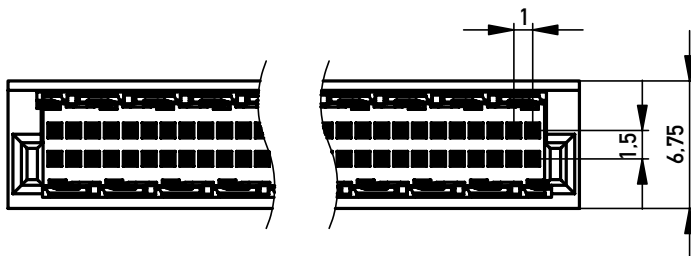

Recommended Layout

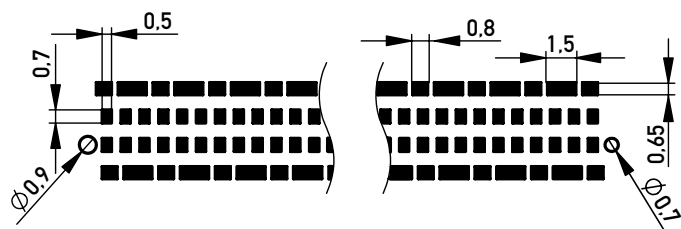

COMBI-MODULE

Product Specification

- right angle, 2-row
- 26 pins
- combined male and female connector
- data rates up to 25 Gbit/s
- shield contacts available in SMT
- tape and reel packaging
- for available part numbers please refer to our website

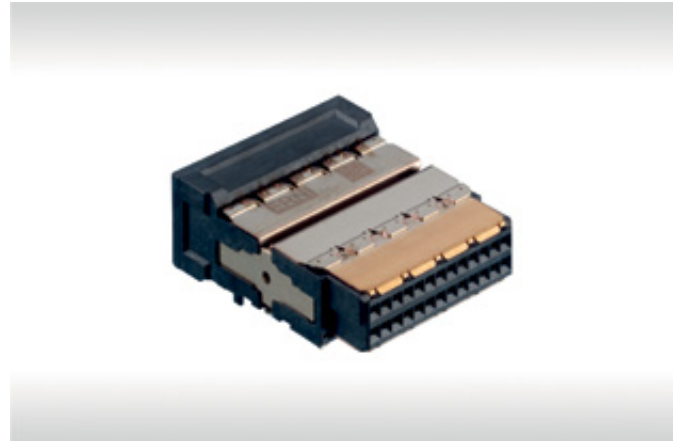

Dimensional Drawings

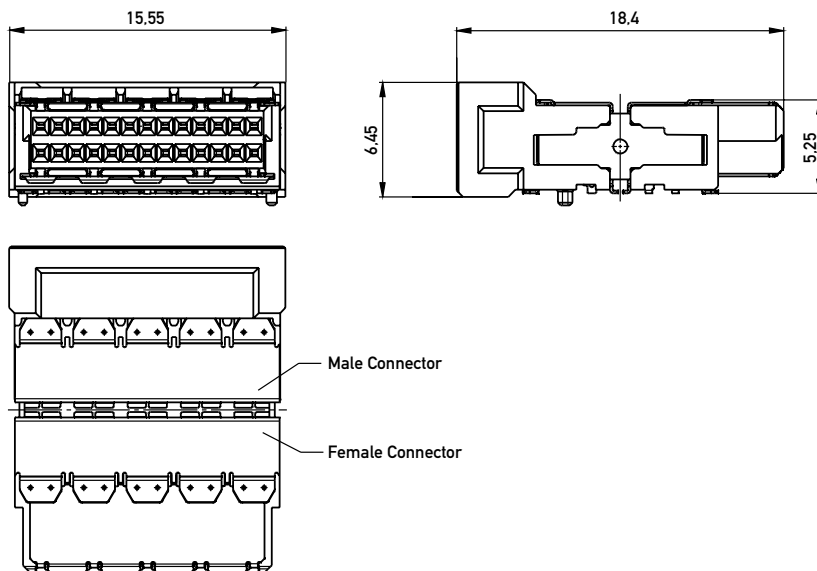

BLIND MATE EMC ENHANCED, VERTICAL FEMALE

Product Specification

- vertical, 3-row
- 75 pins
- Blind Mate design
- data rates up to 25 Gbit/s
- EMC enhanced shielding
- shield contacts available in SMT
- height: 4 mm
- tape and reel packaging
- for available part numbers please refer to our website

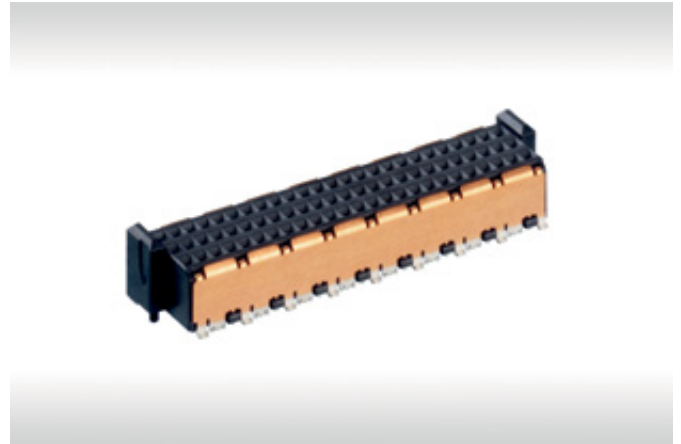

Dimensional Drawings | 50 Pin Version

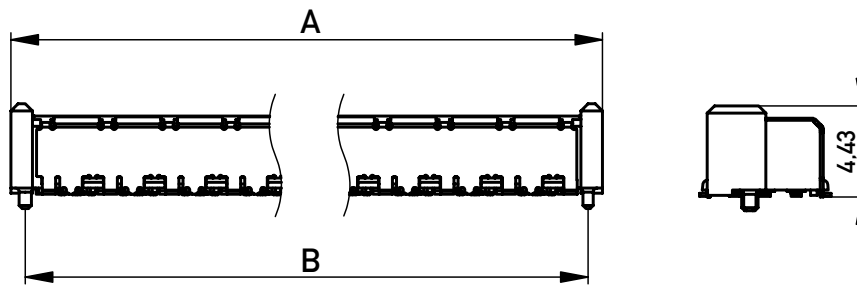

No. of Contacts	A	B
75	27.40	26.00

All dimensions in mm

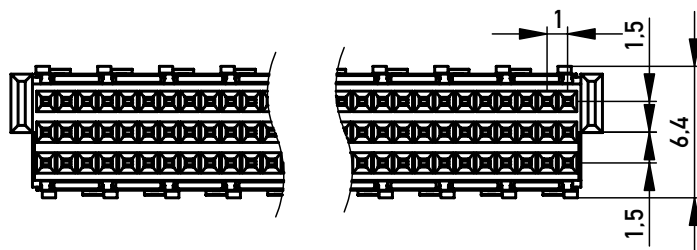

Recommended Layout

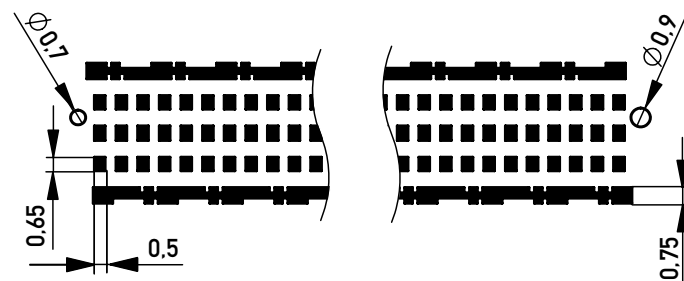

BLIND MATE EMC ENHANCED, VERTICAL MALE

Product Specification

- vertical, 3-row
- 75 pins
- Blind Mate design
- data rates up to 25 Gbit/s
- EMC enhanced shielding
- shield contacts available in SMT
- height: 1 mm
- tape and reel packaging
- for available part numbers please refer to our website

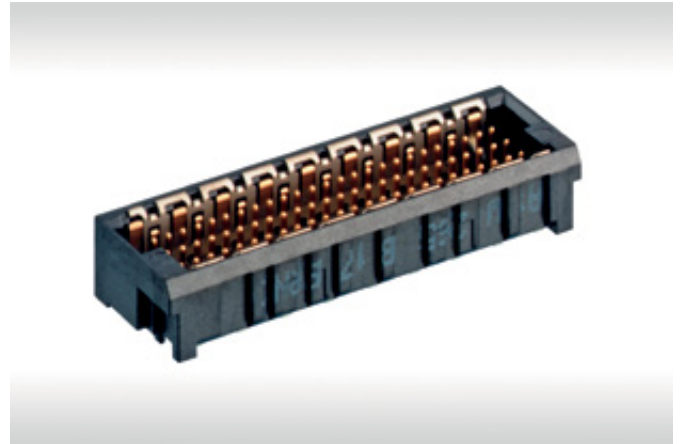

Dimensional Drawings | 50 Pin Version

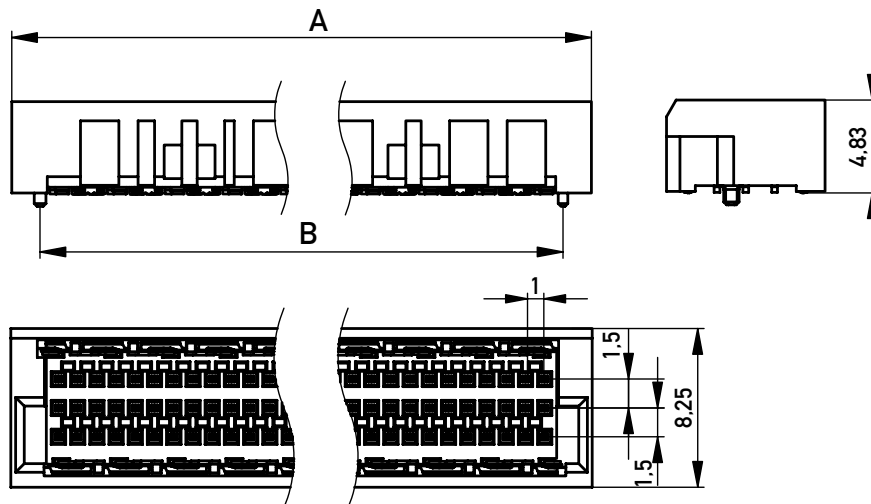

No. of Contacts	A	B
75	28.95	26.00

Recommended Layout

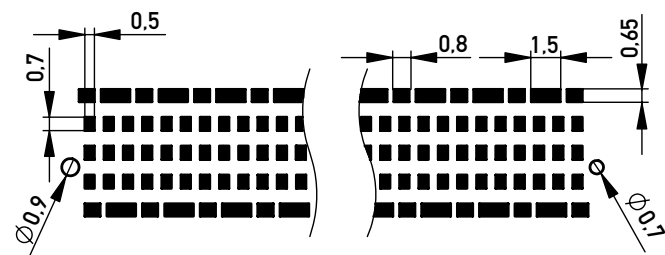

STANDARD, VERTICAL FEMALE

Product Specification

- vertical, 7-row
- 91, 133 pins
- data rates up to 25 Gbit/s
- standard shielding
- shield contacts available in SMT or THR
- height: 4 mm
- tape and reel packaging
- for available part numbers please refer to our website

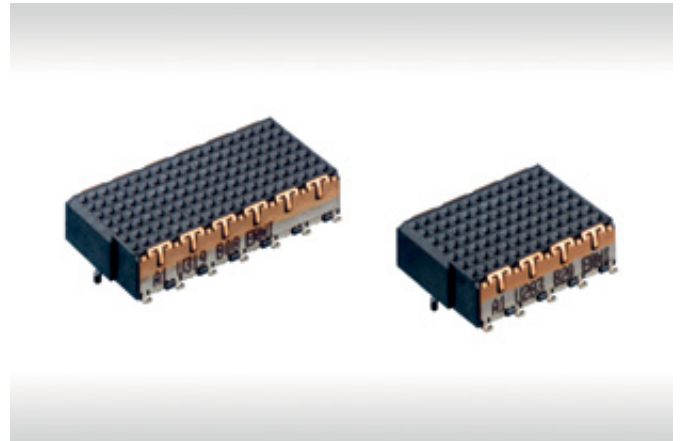

Dimensional Drawings | 50 Pin Version

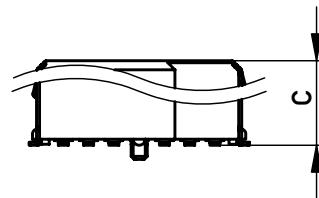
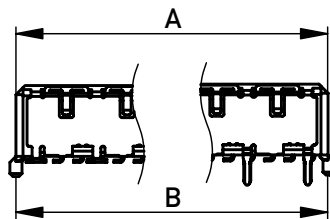

Stacking Height	C
4 mm	3.80

No. of Contacts	A	B
91	14.00	14.00
133	20.00	20.00

All dimensions in mm

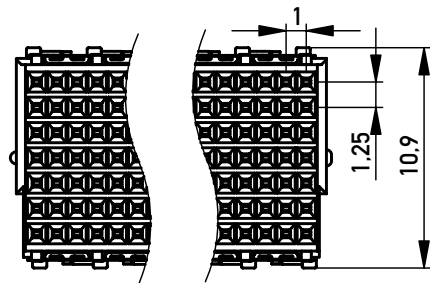

Recommended Layout

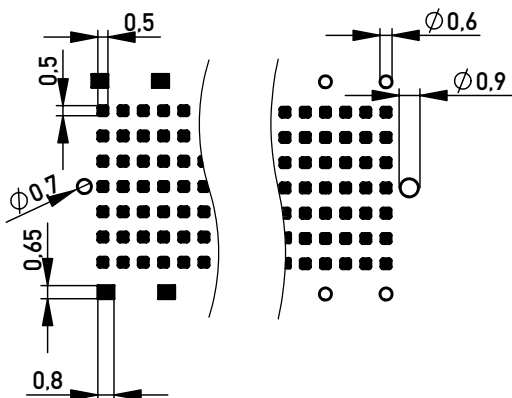

BLIND MATE, VERTICAL FEMALE

Product Specification

- vertical, 7-row
- 91, 133 pins
- Blind Mate design
- data rates up to 25 Gbit/s
- standard shielding
- shield contacts available in SMT or THR
- heights: 4, 6 mm
- tape and reel packaging
- for available part numbers please refer to our website

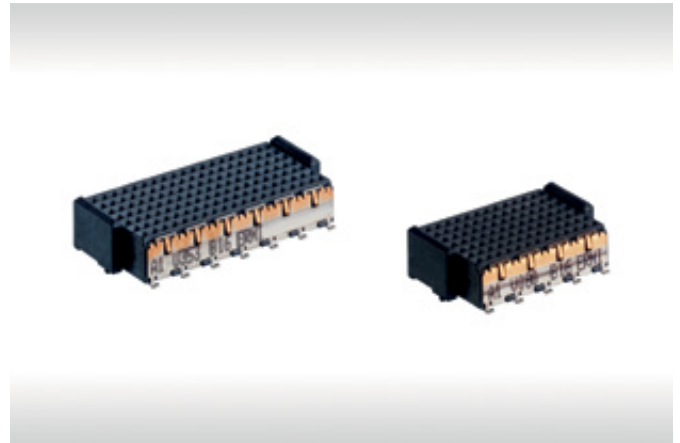

Dimensional Drawings | 50 Pin Version

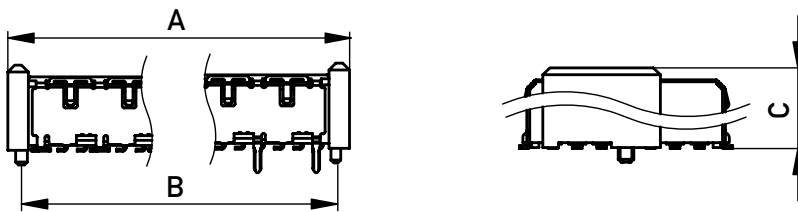

Stacking Height	C
4 mm	4.40
6 mm	6.40

No. of Contacts	A	B
91	15.40	14.00
133	21.40	20.00

All dimensions in mm

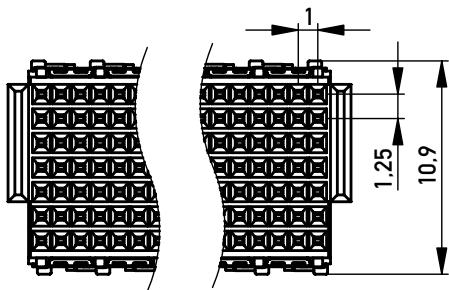

Recommended Layout

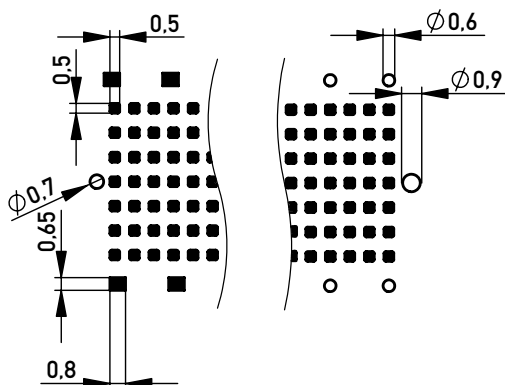

BLIND MATE EMC ENHANCED, VERTICAL FEMALE

Product Specification

- vertical, 7-row
- 91, 133 pins
- Blind Mate design
- data rates up to 25 Gbit/s
- EMC enhanced shielding
- shield contacts available in SMT
- heights: 6, 8 mm
- tape and reel packaging numbers please refer to our website

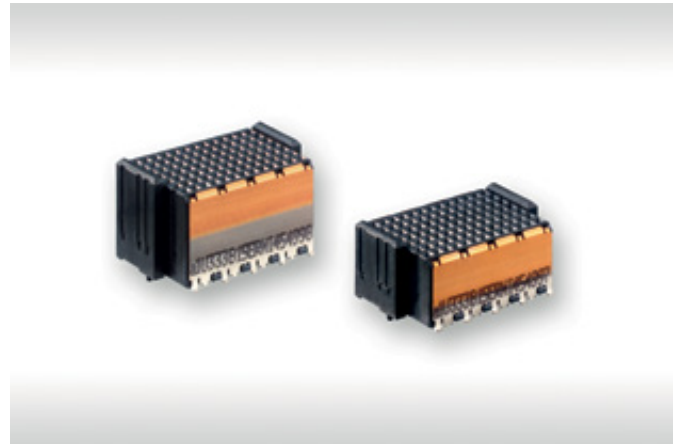

Dimensional Drawings | 50 Pin Version

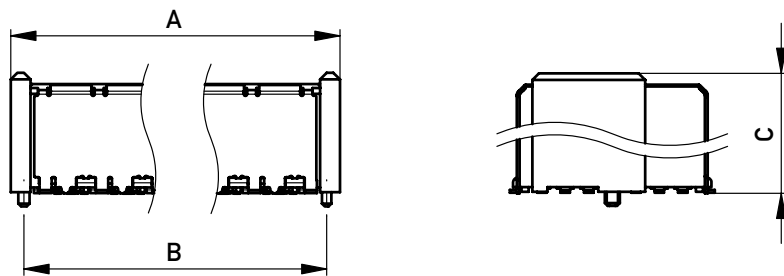

Stacking Height	C
6 mm	6.40
8 mm	8.40

No. of Contacts	A B	
	A	B
91	15.40	14.00
133	21.40	20.00

All dimensions in mm

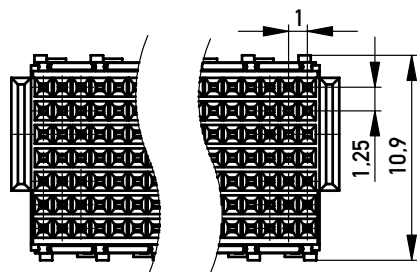

Recommended Layout

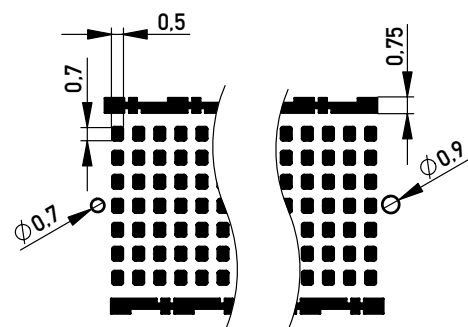

STANDARD, VERTICAL MALE

Product Specification

- vertical, 7-row
- 91, 133 pins
- data rates up to 25 GBit/s
- standard shielding
- shield contacts available in SMT or THR
- height: 1 mm
- tape and reel packaging
- for available part numbers please refer to our website

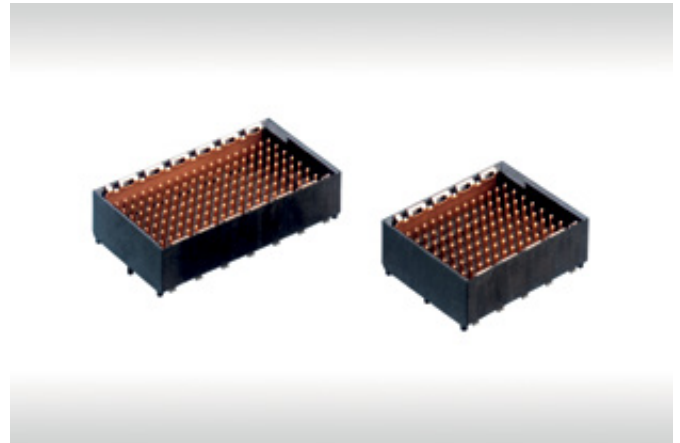

Dimensional Drawings | 50 Pin Version

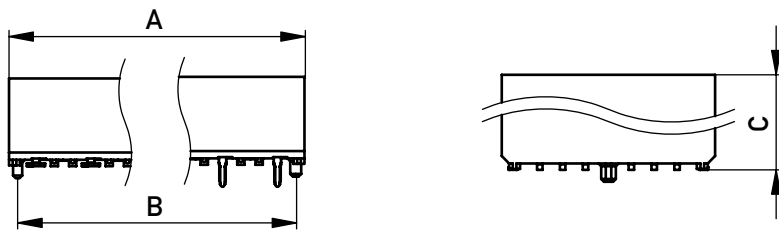

Stacking Height	C
1 mm	4.80

No. of Contacts	A B	
	A	B
91	14.95	14.00
133	20.95	20.00

All dimensions in mm

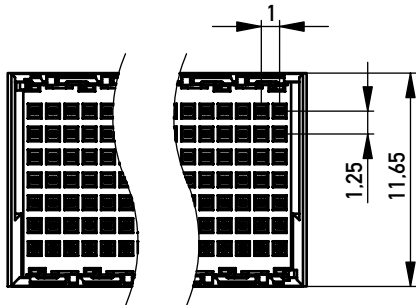

Recommended Layout

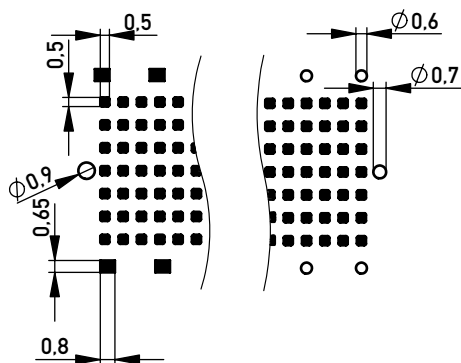

BLIND MATE, VERTICAL MALE

Product Specification

- vertical, 7-row
- 91, 133 pins
- Blind Mate design
- data rates up to 25 Gbit/s
- standard shielding
- shield contacts available in SMT or THR
- heights: 1, 2 mm
- tape and reel packaging
- for available part numbers please refer to our website



Dimensional Drawings | 50 Pin Version

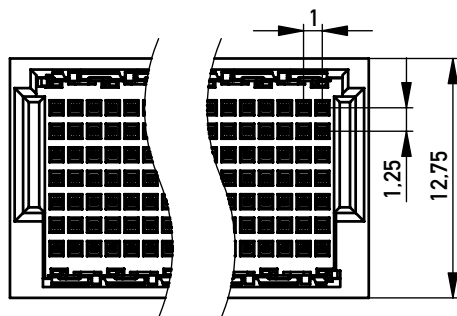
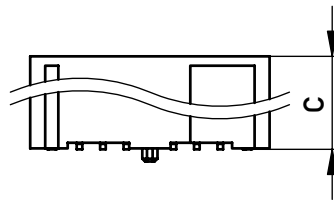
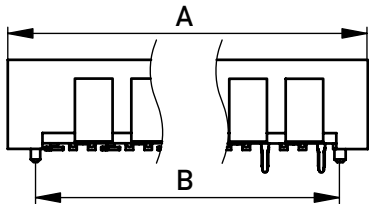

Stacking Height	C
1 mm	4.80
2 mm	5.80

No. of Contacts	A	B
91	16.95	14.00
133	22.95	20.00

All dimensions in mm

Recommended Layout

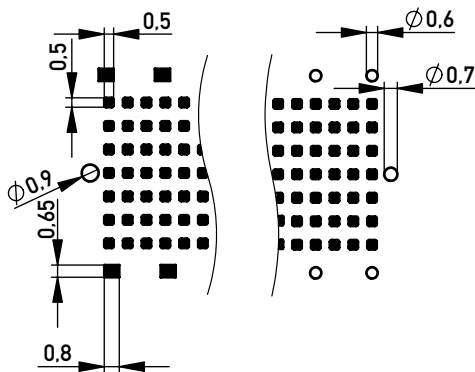

BLIND MATE EMC ENHANCED, VERTICAL MALE

Product Specification

- vertical, 7-row
- 91, 133 pins
- Blind Mate design
- data rates up to 25 Gbit/s
- EMC enhanced shielding
- shield contacts available in SMT
- heights: 1, 2 mm
- tape and reel packaging
- for available part numbers please refer to our website



Dimensional Drawings | 50 Pin Version

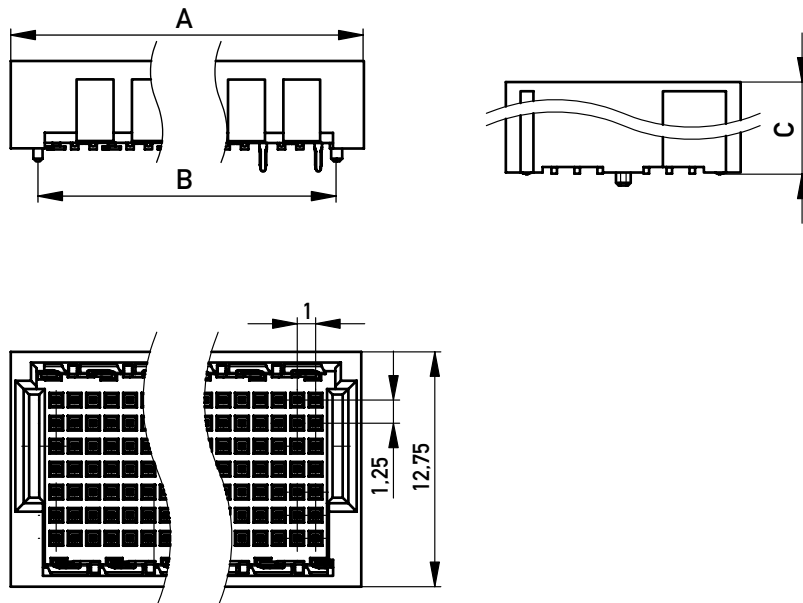

Stacking Height	C
1 mm	4.80
2 mm	5.80

No. of Contacts	A	B
91	16.95	14.00
133	22.95	20.00

All dimensions in mm

Recommended Layout

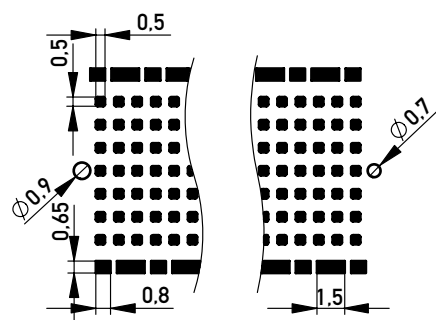

Connect With Us

We make it easy to connect with our experts and are ready to provide zthe support you need. Visit www.te.com/support to chat with a Product Information Specialist.

te.com

2023 TE Connectivity. All Rights Reserved.

TE Connectivity, TE connectivity (logo), ERNI, MicroSpeed and Every Connection Counts are trademarks owned or licensed by the TE Connectivity family of companies. All other logos, products and/or company names referred to herein might be trademarks of their respective owners.

The information given herein, including drawings, illustrations and schematics which are intended for illustration purposes only, is believed to be reliable. However, TE Connectivity makes no warranties as to its accuracy or completeness and disclaims any liability in connection with its use. TE Connectivity's obligations shall only be as set forth in TE Connectivity's Standard Terms and Conditions of Sale for this product and in no case will TE Connectivity be liable for any incidental, indirect or consequential damages arising out of the sale, resale, use or misuse of the product. Users of TE Connectivity products should make their own evaluation to determine the suitability of each such product for the specific application.

JS 10/23 Original

CATALOG

TE Connectivity

ERNI Deutschland GmbH
a TE Connectivity Ltd. company
Seestraße 9
73099 Adelberg
Germany

Tel +49 7166 50-0
www.te.com