



ANT-5GWWS2-SMA

Cellular Sub-6 5G Antenna

The 5GWWS2 is a dipole, blade-style antenna for 5G New Radio, LTE, and cellular IoT (LTE-M, NB-IoT) applications. As a 5G NR antenna, the 5GWWS2 performs in the 617 MHz to 960 MHz low band, and excels in the 2496 MHz to 2690 MHz and 3300 MHz to 5000 MHz ranges for CBRS private networking, 4.9 GHz public safety and emerging 2.5 GHz and C-band applications.

The hinged design allows for the antenna to be positioned for optimum performance and reduces the potential for damage from impact compared to a fixed whip design. The antenna attaches with an SMA plug (male pin) connector.

FEATURES

- Performance at 3.55 GHz to 3.7 GHz (CBRS)
 - VSWR: ≤ 2.1
 - Peak Gain: 5.6 dBi
 - Efficiency: 65%
- Performance at 4.94 GHz to 4.99 GHz
 - VSWR: ≤ 1.9
 - Peak Gain: 3.6 dBi
 - Efficiency: 69%
- Hinged design with detents for straight, 45 degree and 90 degree positioning
- IP67 rated

APPLICATIONS

- Worldwide 5G/4G/3G/2G
- Cellular IoT: LTE-M (Cat-M1) and NB-IoT
- Private cellular networks
 - Citizens Broadband Radio Service (CBRS)
- 4.9 GHz Public Safety
- Emerging 5G C-Band applications
- Emerging 5G 2.5 GHz EBS applications
- 2.4 GHz ISM applications
 - Bluetooth®
 - ZigBee®
- Internet of Things (IoT) devices

ORDERING INFORMATION

Part Number	Description
ANT-5GWWS2-SMA	Cellular 5G blade-style antenna with SMA plug (male pin)

Available from Linx Technologies and select distributors and representatives.

TABLE 1. ELECTRICAL SPECIFICATIONS

ANT-5GWWS2	Frequency Range	VSWR (max.)	Peak Gain (dBi)	Avg. Gain (dBi)	Efficiency (%)
LTE 71	617 MHz to 698 MHz	4.0	0.6	-3.1	53
LTE 12, 13, 14, 17, 26, 28, 29	698 MHz to 803 MHz	3.3	-0.1	-4.1	43
LTE 5, 8, 20	791 MHz to 960 MHz	3.5	0.5	-5.6	43
LTE 1, 2, 3, 4, 25, 66	1710 MHz to 2200 MHz	2.5	3.3	-2.3	62
LTE 30, 40	2300 MHz to 2400 MHz	2.4	2.7	-1.8	68
ISM	2400 MHz to 2485 MHz	1.7	2.7	-1.9	69
LTE 7, 41	2496 MHz to 2690 MHz	2.0	1.6	-1.4	77
LTE 22, 42, 43, 48, 49, 52	3300 MHz to 3800 MHz	2.2	4.0	-2.2	63
GPS/GNSS	1553 MHz to 1609 MHz	1.5	2.4	-2.2	63
CBRS	3550 MHz to 3700 MHz	2.1	5.6	-2.1	65
C-Band	3700 MHz to 4200 MHz	2.4	3.7	-2.8	57
Public Safety	4940 MHz to 4990 MHz	1.9	3.6	-1.7	69

TABLE 2. MECHANICAL SPECIFICATIONS

Parameter	Value
Polarization	Linear
Radiation	Omnidirectional
Max Power	5W
Wavelength	1/2-wave
Electrical Type	Dipole
Impedance	50 Ω
Connection	SMA plug (male pin)
Operating Temperature Range	-20 °C to +65 °C
Weight	38.0 g (1.34 oz)
Dimensions	186.0 mm x 37.0 mm x 13.0 (7.32 in x 1.46 in x 0.51 in)

Electrical specifications and plots measured with the antenna in a straight orientation.

PRODUCT DIMENSIONS

Figure 1 provides dimensions of the 5GWWS2. The antenna whip can be tilted 90 degrees, with a detent at 45 degrees enabling the antenna to be oriented in any direction. The rotating base allows for continuous positioning through 360 degrees even while installed. There is an additional rotation point above the hinge which allows the antenna to rotate independently of the base while in the bent orientation.

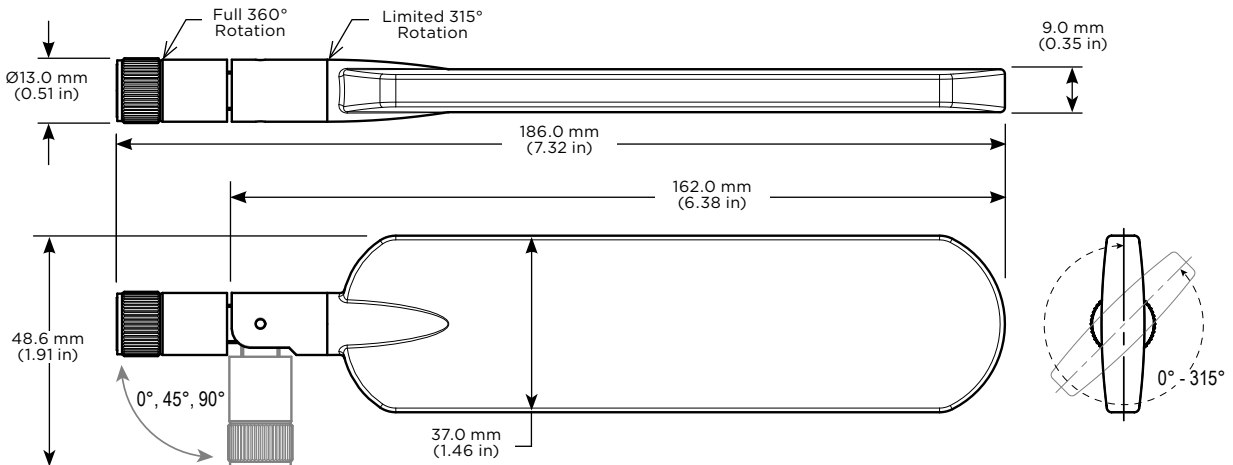

Figure 1: ANT-5GWWS2-SMA Antenna Dimensions

PACKAGING INFORMATION

The 5GWWS2 antennas are individually sealed in a clear plastic bag. 200 bags per carton, 390 mm x 260 mm x 330 mm (15.4 in x 10.24 in x 13.0 in), total weight 7.8 kgs (17.2 lb). Distribution channels may offer alternative packaging options.

ANTENNA ORIENTATION

The 5GWWS2 antenna is characterized in two antenna orientations as shown in Figure 2. The antenna straight orientation characterizes use of an antenna attached to an enclosure-mounted connector which is connected by cable to a printed circuit board. Although the antenna is a dipole not requiring a ground plane for function, characterization with an adjacent ground plane (102 mm x 102 mm) provides insight into antenna performance when attached directly to a printed circuit board mounted connector. The two orientations represent the most common end-product use cases.

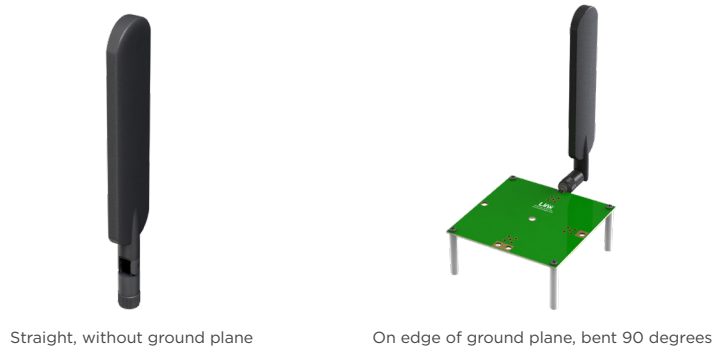

Figure 2. ANT-5GWWS2-SMA on evaluation PCB

STRAIGHT, NO GROUND PLANE

The charts on the following pages represent data taken with the antenna oriented straight, as shown in Figure 3.



Figure 3. ANT-5GWWS2-SMA Straight, No Ground Plane (Straight)

VSWR

Figure 4 provides the voltage standing wave ratio (VSWR) across the antenna bandwidth. VSWR describes the power reflected from the antenna back to the radio. A lower VSWR value indicates better antenna performance at a given frequency. Reflected power is also shown on the right-side vertical axis as a gauge of the percentage of transmitter power reflected back from the antenna.

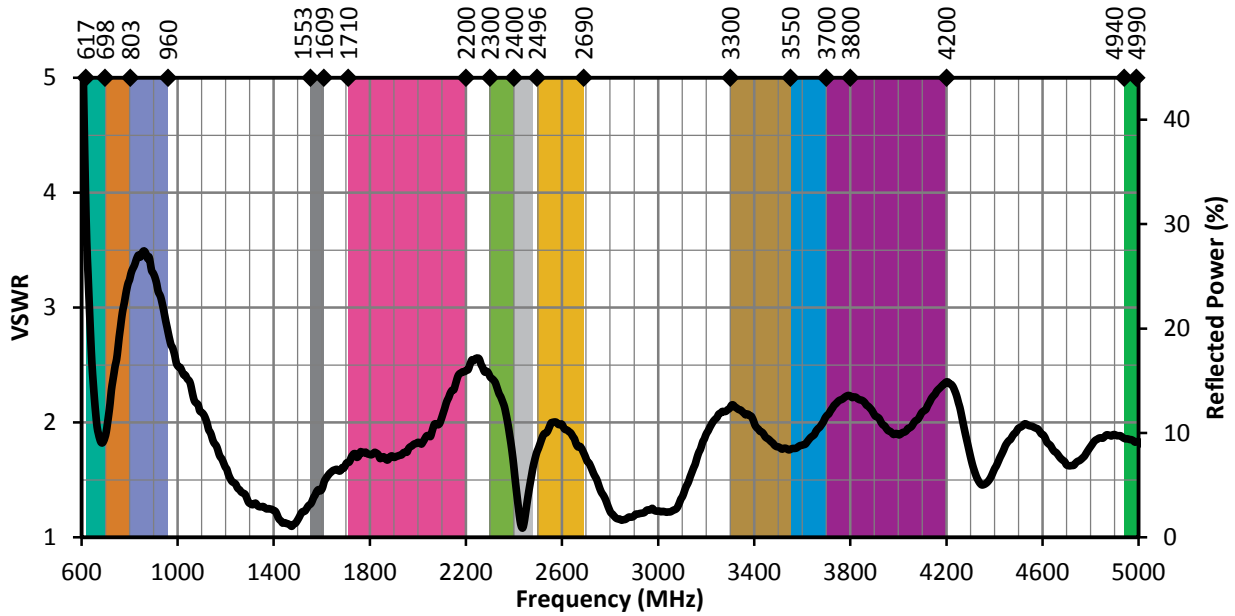

Figure 4. ANT-5GWWS2-SMA VSWR, Straight

RETURN LOSS

Return loss (Figure 5), represents the loss in power at the antenna due to reflected signals. Like VSWR, a lower return loss value indicates better antenna performance at a given frequency.

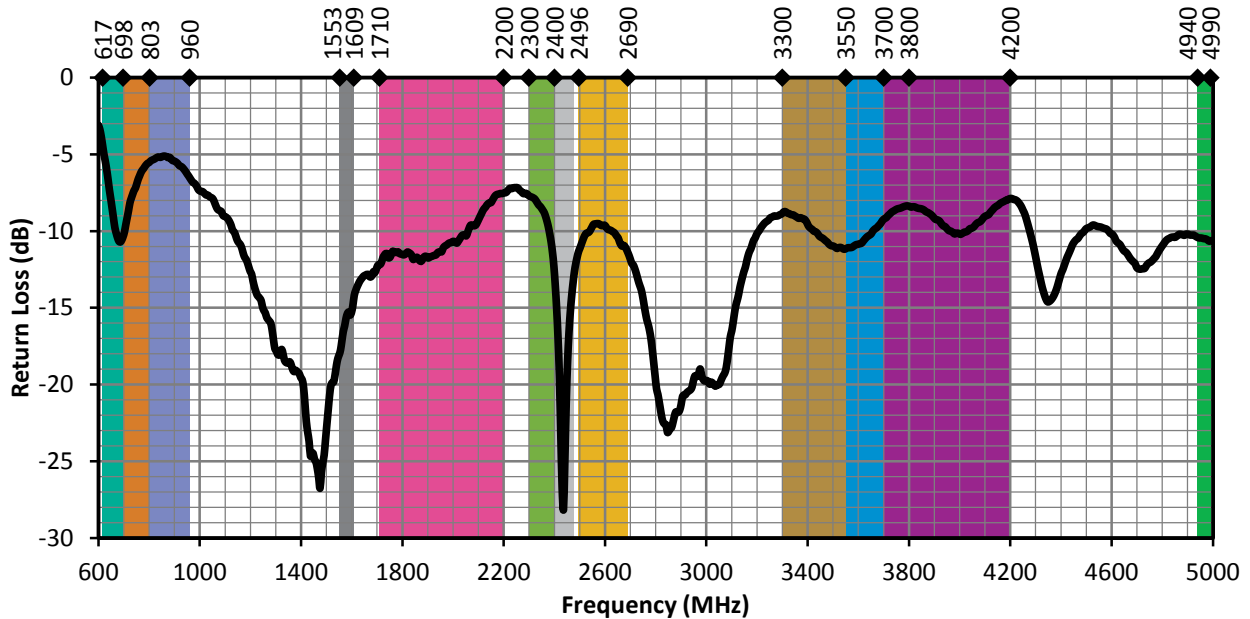

Figure 5. ANT-5GWWS2-SMA Return Loss, Straight

PEAK GAIN

The peak gain across the antenna bandwidth is shown in Figure 6. Peak gain represents the maximum antenna input power concentration across 3-dimensional space, and therefore peak performance at a given frequency, but does not consider any directionality in the gain pattern.

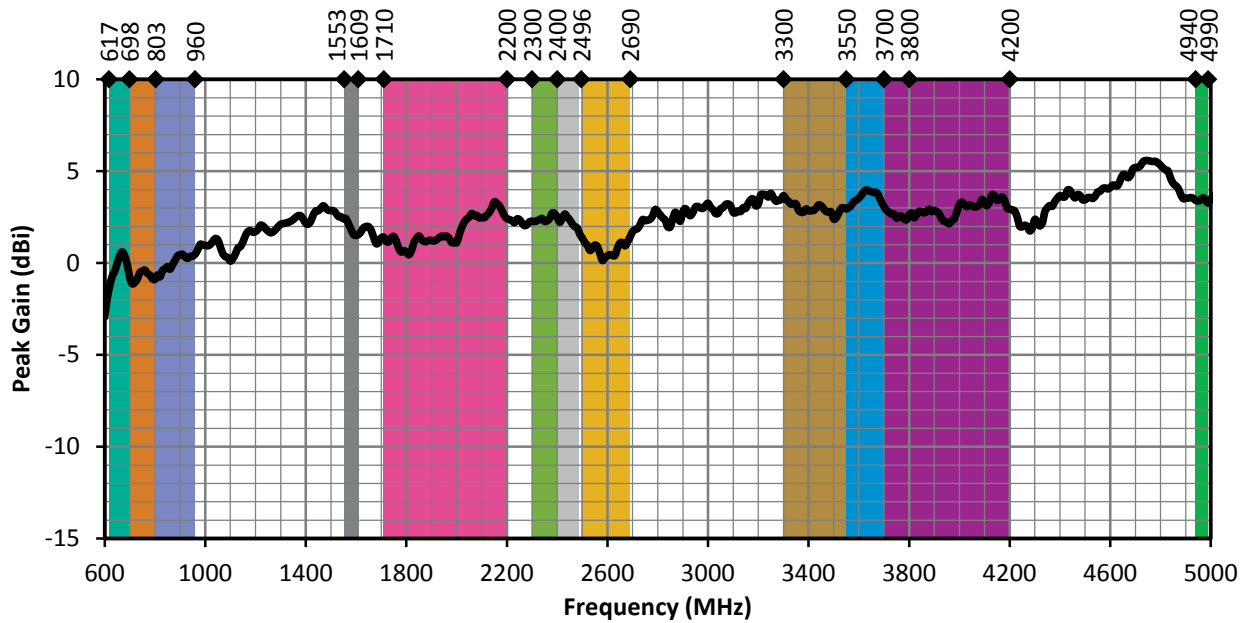

Figure 6. ANT-5GWWS2-SMA Peak Gain, Straight

AVERAGE GAIN

Average gain (Figure 7), is the average of all antenna gain in 3-dimensional space at each frequency, providing an indication of overall performance without expressing antenna directionality.

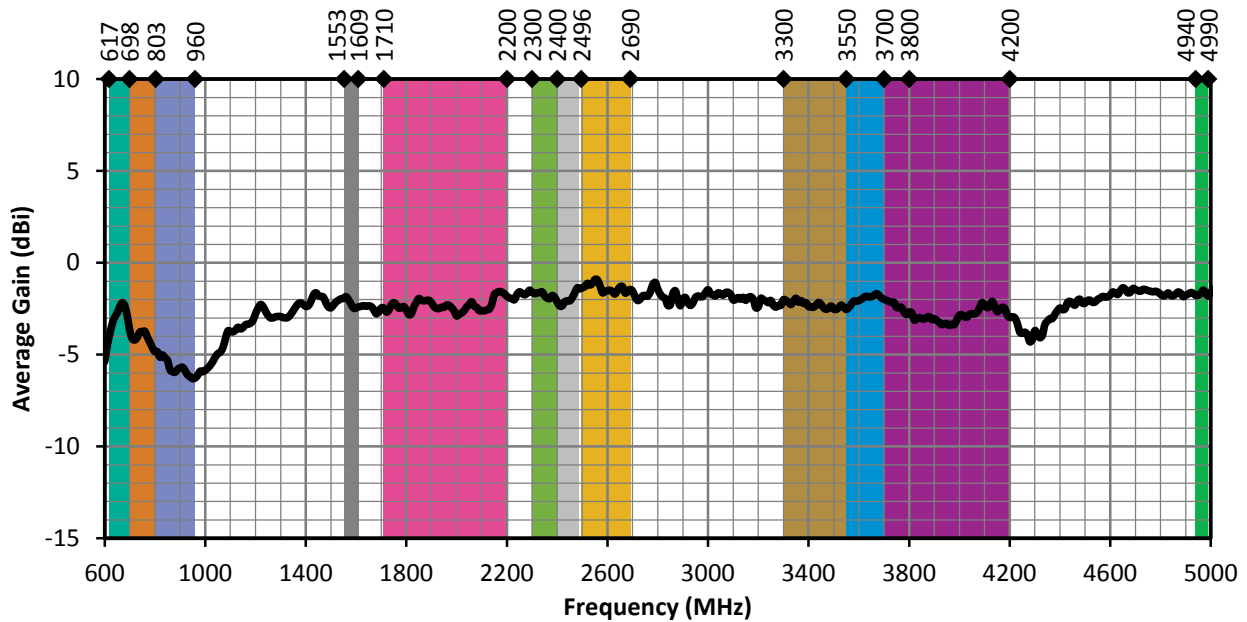

Figure 7. ANT-5GWWS2-SMA Antenna Average Gain, Straight

RADIATION EFFICIENCY

Radiation efficiency (Figure 8), shows the ratio of power delivered to the antenna relative to the power radiated at the antenna, expressed as a percentage, where a higher percentage indicates better performance at a given frequency.

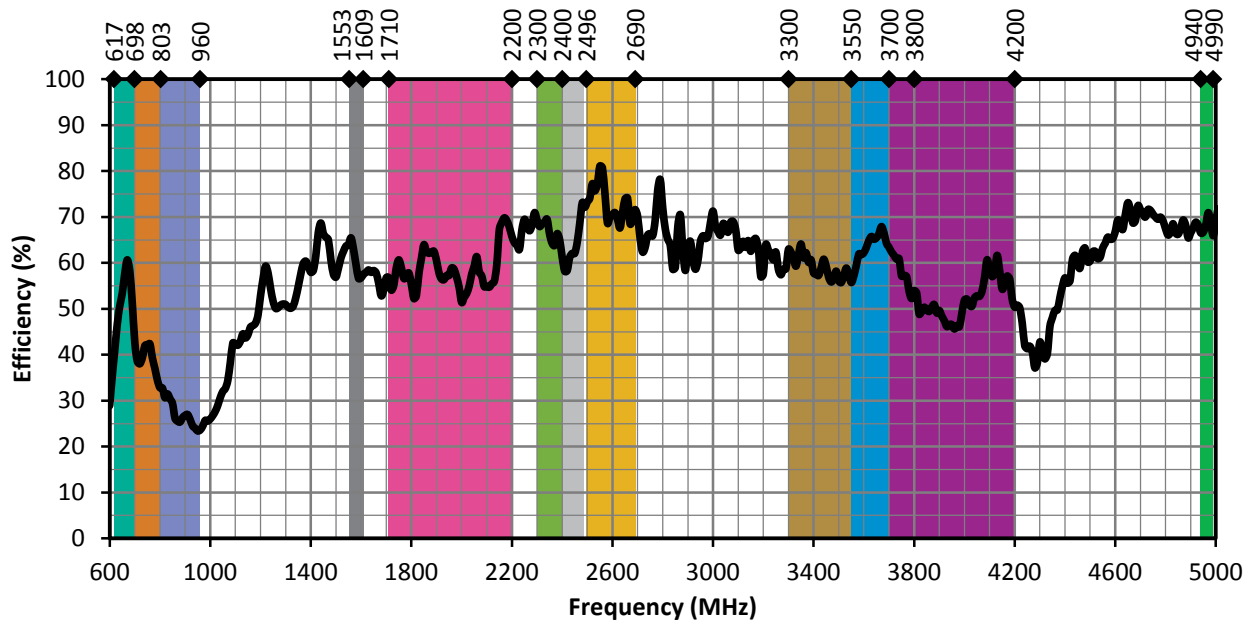

Figure 8. ANT-5GWWS2-SMA Antenna Efficiency, Straight

RADIATION PATTERNS

Radiation patterns provide information about the directionality and 3-dimensional gain performance of the antenna by plotting gain at specific frequencies in three orthogonal planes. Antenna radiation patterns for an orientation at the center of the ground plane are shown in Figure 9 using polar plots covering 360 degrees. The antenna graphic at the top of the page provides reference to the plane of the column of plots below it. Note: when viewed with typical PDF viewing software, zooming into radiation patterns is possible to reveal fine detail.

RADIATION PATTERNS - STRAIGHT



XZ-Plane Gain

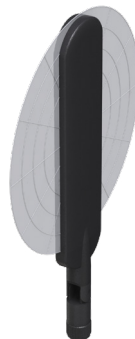

YZ-Plane Gain

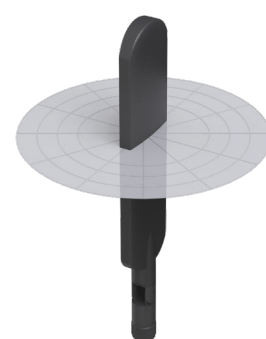

XY-Plane Gain

617 MHz TO 698 MHz (660 MHz)

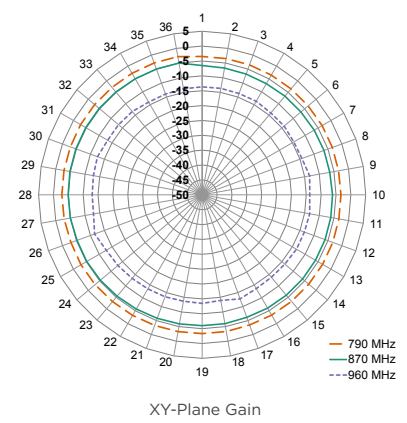
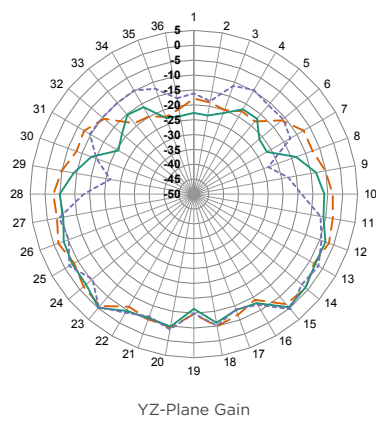
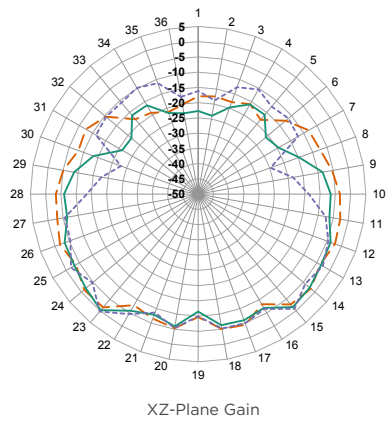

698 MHz TO 803 MHz (750 MHz)

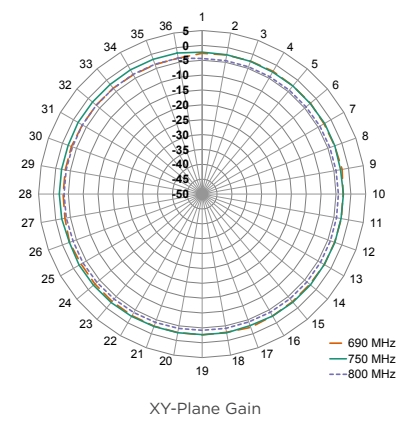
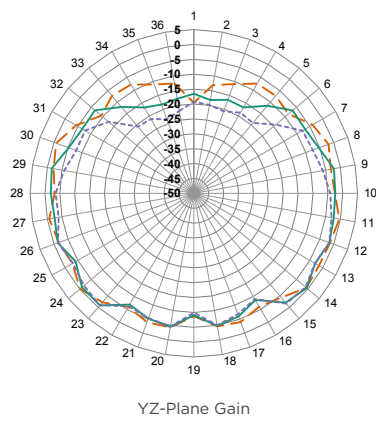
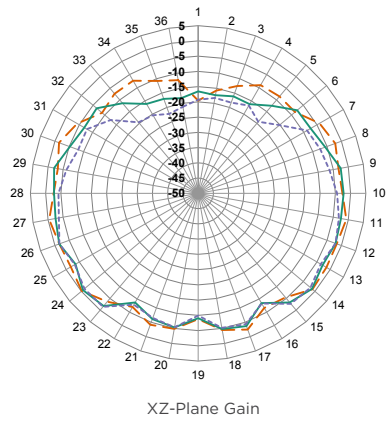

RADIATION PATTERNS - STRAIGHT

791 MHz TO 960 MHz (870 MHz)

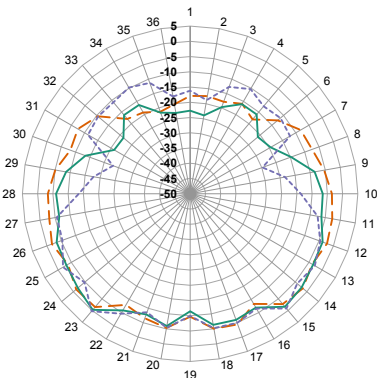

XZ-Plane Gain

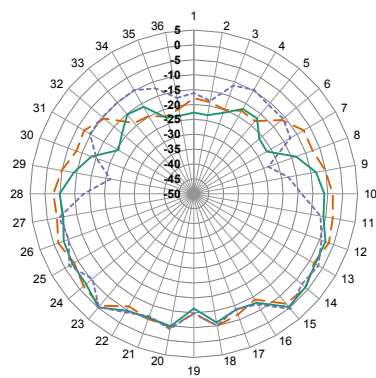

YZ-Plane Gain

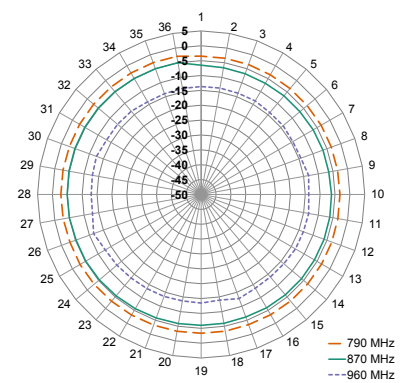

XY-Plane Gain

1710 MHz TO 2200 MHz (1950 MHz)

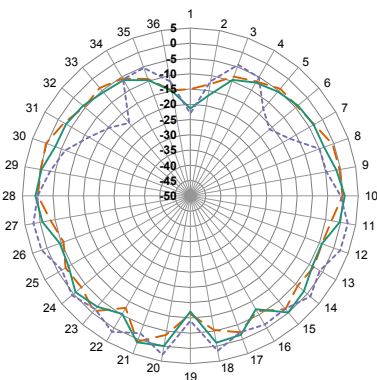

XZ-Plane Gain

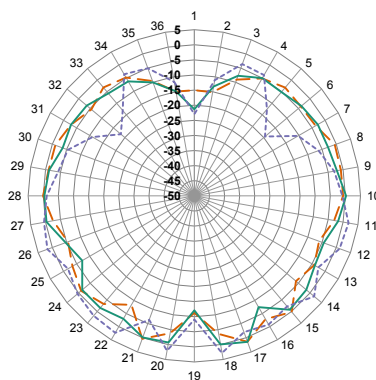

YZ-Plane Gain

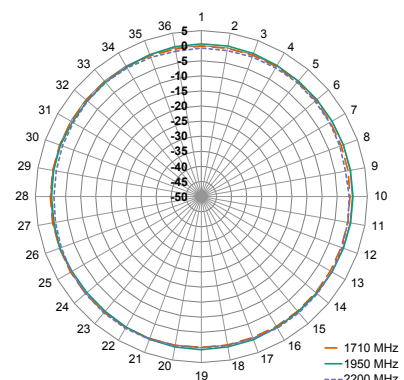

XY-Plane Gain

2300 MHz TO 2400 MHz (2350 MHz)

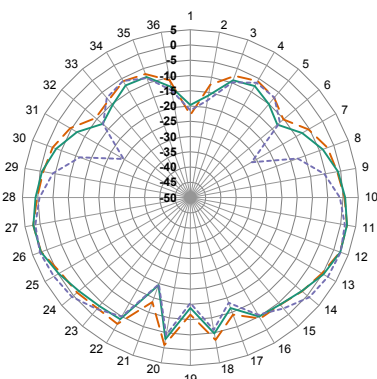

XZ-Plane Gain

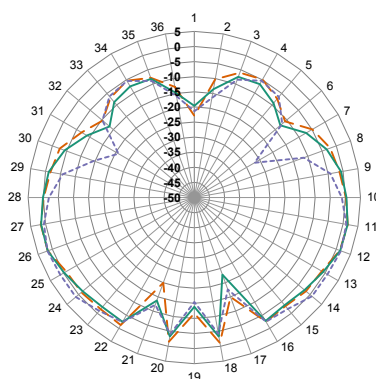

YZ-Plane Gain

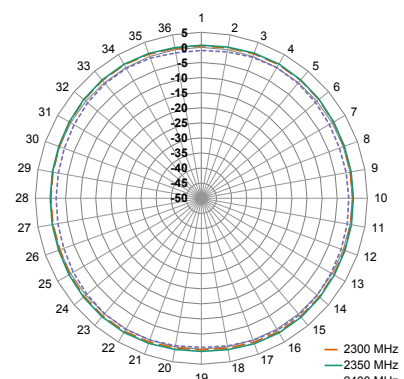

XY-Plane Gain

RADIATION PATTERNS - STRAIGHT

2496 MHz TO 2690 MHz (2600 MHz)

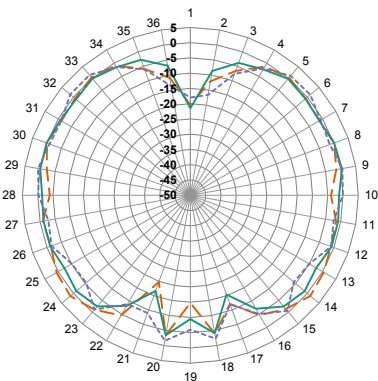

XZ-Plane Gain

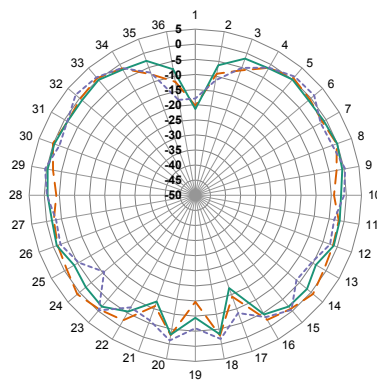

YZ-Plane Gain

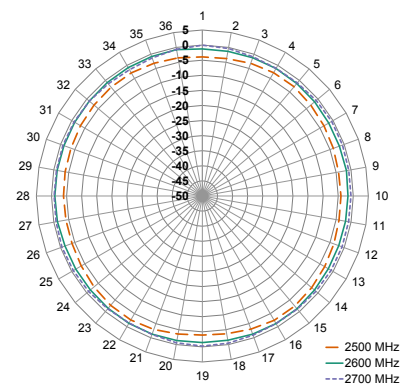

XY-Plane Gain

3300 MHz TO 3800 MHz (3550 MHz)

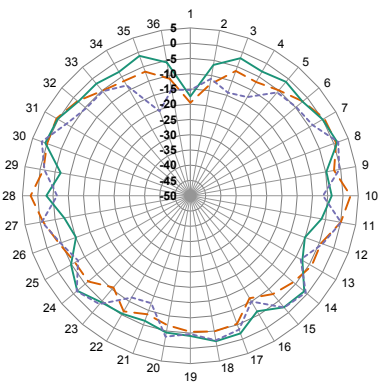

XZ-Plane Gain

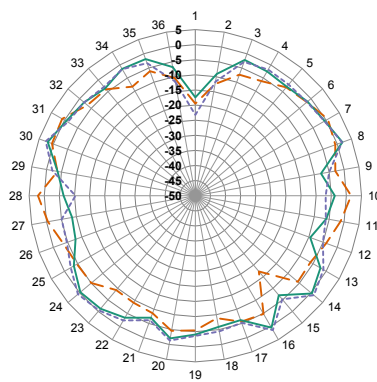

YZ-Plane Gain

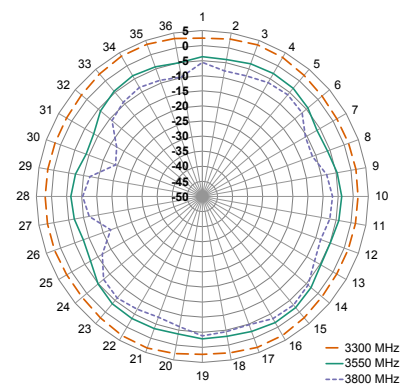

XY-Plane Gain

1553 MHz TO 1609 MHz (1580 MHz)

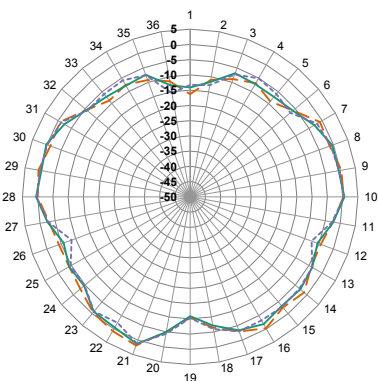

XZ-Plane Gain

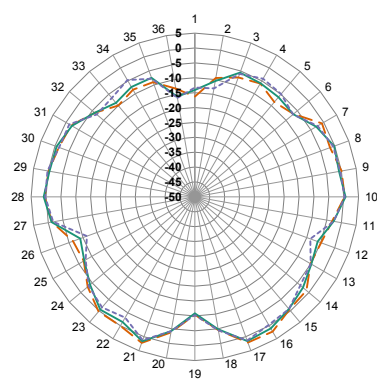

YZ-Plane Gain

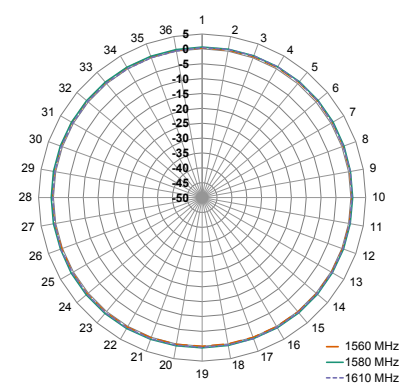

XY-Plane Gain

RADIATION PATTERNS - STRAIGHT

2400 MHz TO 2485 MHz (2450 MHz)

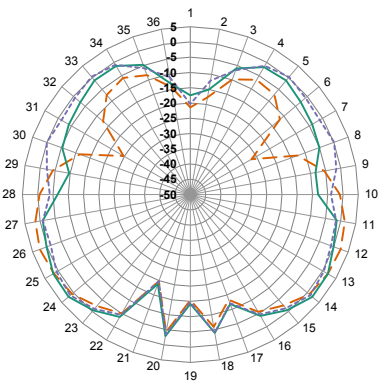

XZ-Plane Gain

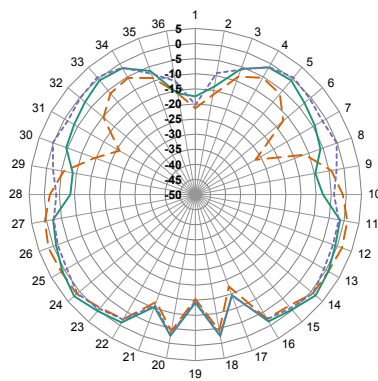

YZ-Plane Gain

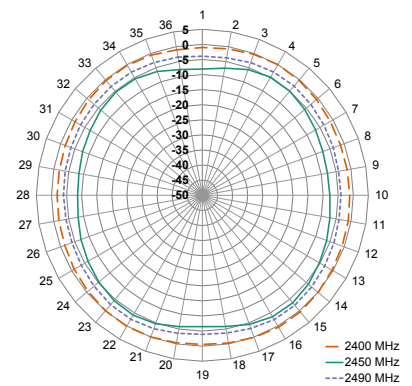

XY-Plane Gain

3550 MHz TO 3700 MHz (3620 MHz)

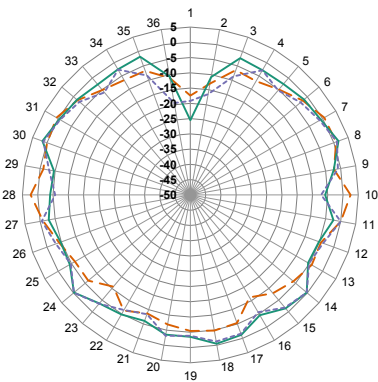

XZ-Plane Gain

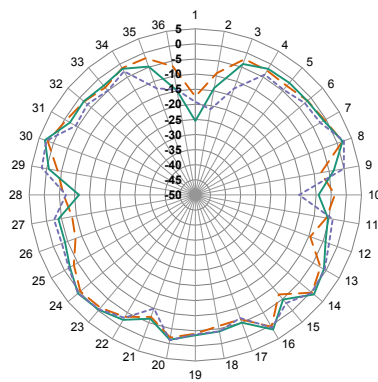

YZ-Plane Gain

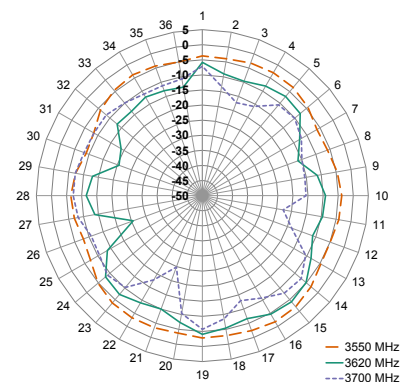

XY-Plane Gain

3700 MHz TO 4200 MHz (3950 MHz)

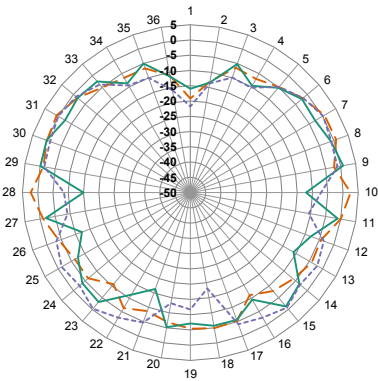

XZ-Plane Gain

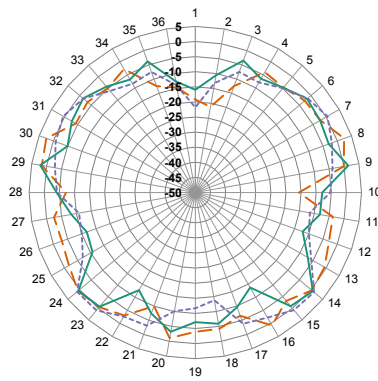

YZ-Plane Gain

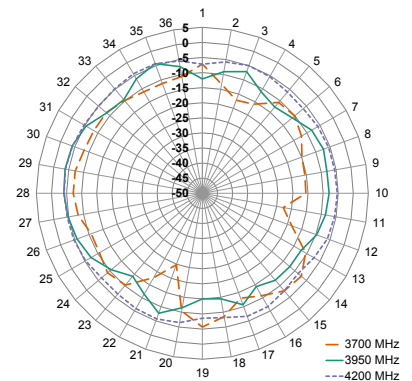

XY-Plane Gain

RADIATION PATTERNS - STRAIGHT

4940 MHz TO 4990 MHz (4960 MHz)

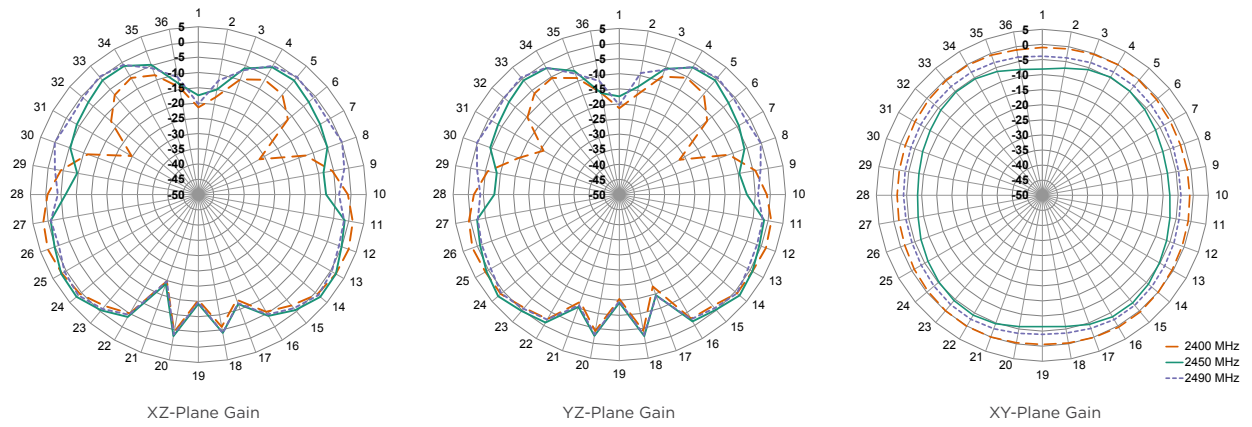

Figure 8. Radiation Patterns for ANT-5GWWS2-SMA, Straight

EDGE OF GROUND PLANE, BENT 90 DEGREES

The charts on the following pages represent data taken with the antenna oriented at the edge of the ground plane, bent 90 degrees (Edge-Bent), as shown in Figure 10.

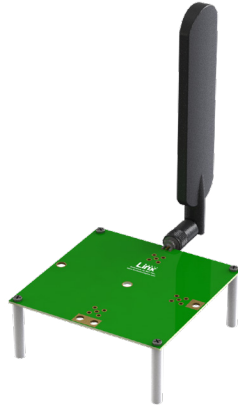

Figure 10. ANT-5GWWS2-SMA on Edge of Ground Plane, Bent 90 Degrees (Edge-Bent)

VSWR

Figure 11 provides the voltage standing wave ratio (VSWR) across the antenna bandwidth. VSWR describes the power reflected from the antenna back to the radio. A lower VSWR value indicates better antenna performance at a given frequency. Reflected power is also shown on the right-side vertical axis as a gauge of the percentage of transmitter power reflected back from the antenna.

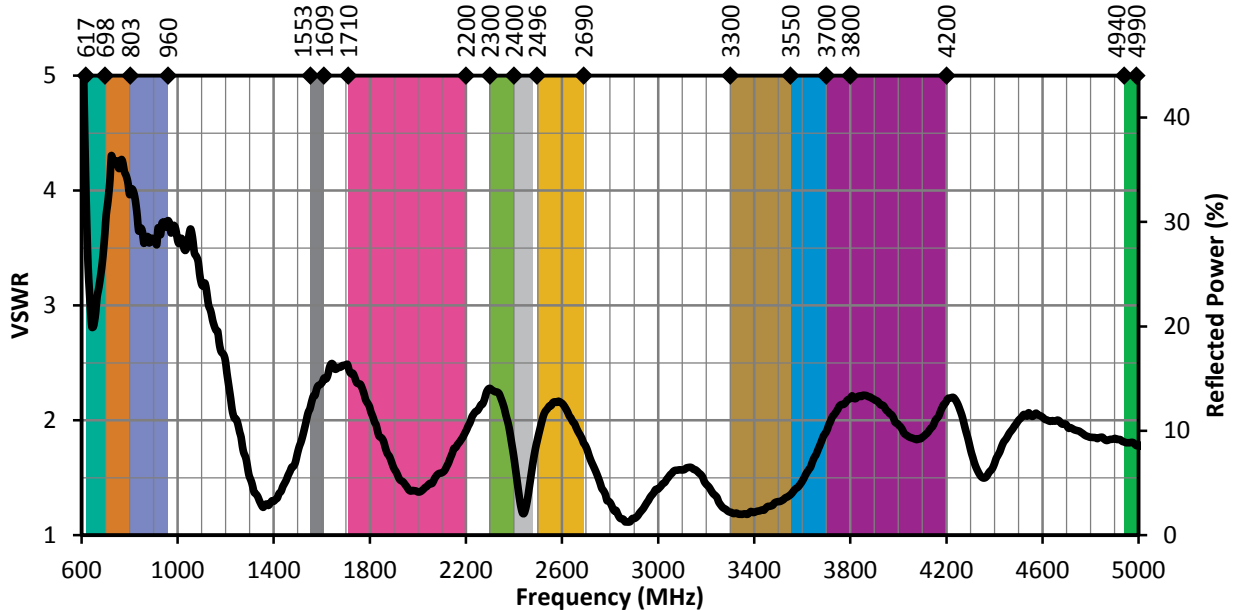

Figure 11. ANT-5GWWS2-SMA VSWR, Edge-Bent

RETURN LOSS

Return loss (Figure 12), represents the loss in power at the antenna due to reflected signals. Like VSWR, a lower return loss value indicates better antenna performance at a given frequency.

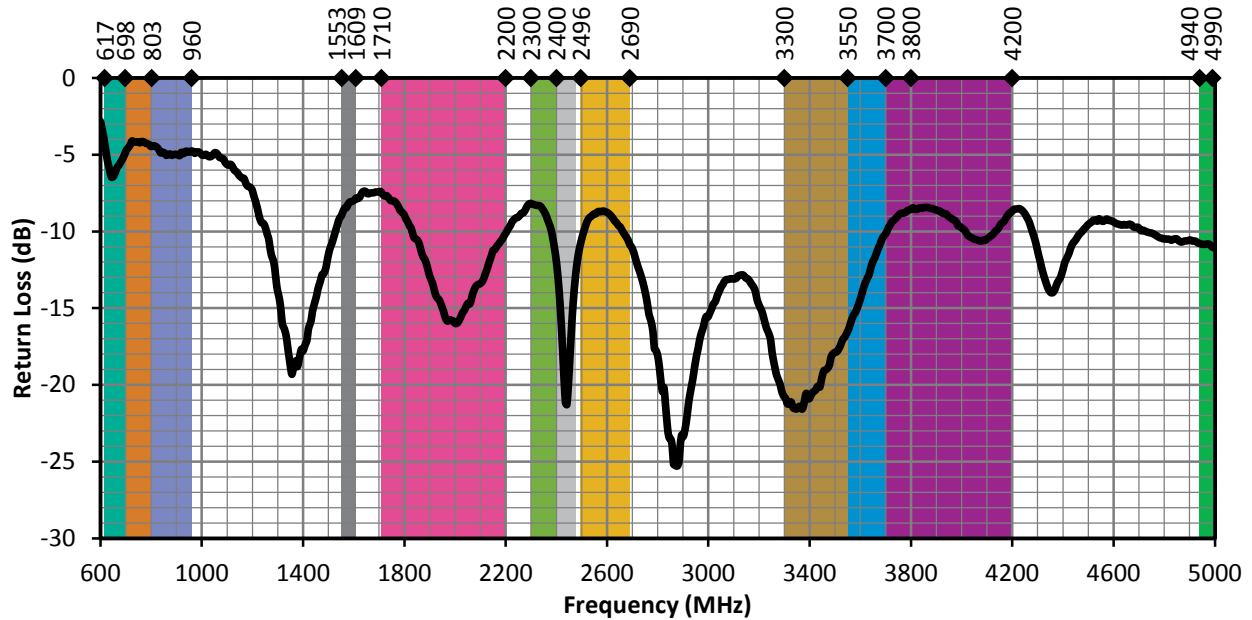

Figure 12. ANT-5GWWS2-SMA Return Loss, Edge-Bent

PEAK GAIN

The peak gain across the antenna bandwidth is shown in Figure 13. Peak gain represents the maximum antenna input power concentration across 3-dimensional space, and therefore peak performance at a given frequency, but does not consider any directionality in the gain pattern.

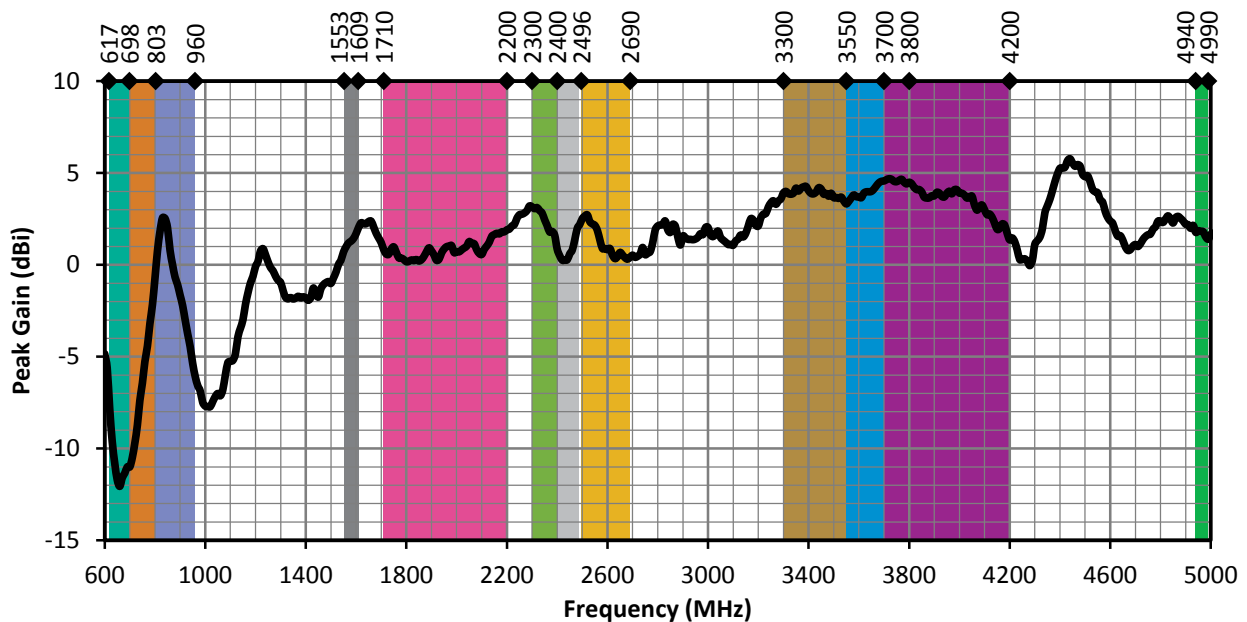

Figure 13. ANT-5GWWS2-SMA Peak Gain, Edge-Bent

AVERAGE GAIN

Average gain (Figure 14), is the average of all antenna gain in 3-dimensional space at each frequency, providing an indication of overall performance without expressing antenna directionality.

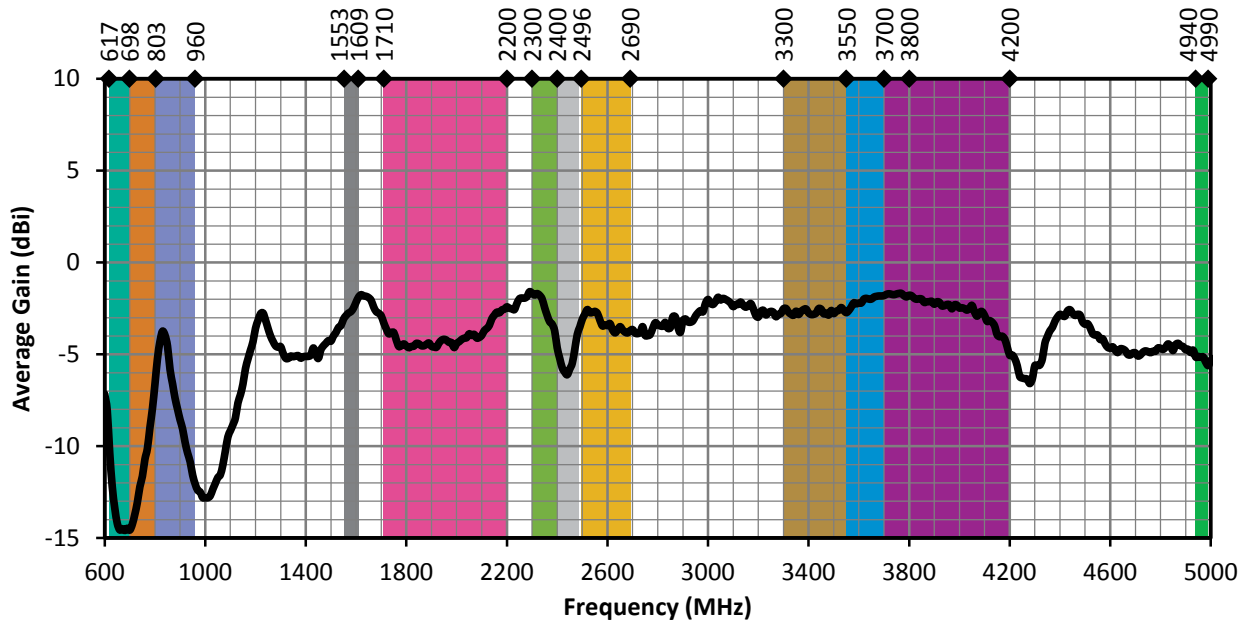

Figure 14. ANT-5GWWS2-SMA Antenna Average Gain, Edge-Bent

RADIATION EFFICIENCY

Radiation efficiency (Figure 15), shows the ratio of power delivered to the antenna relative to the power radiated at the antenna, expressed as a percentage, where a higher percentage indicates better performance at a given frequency.

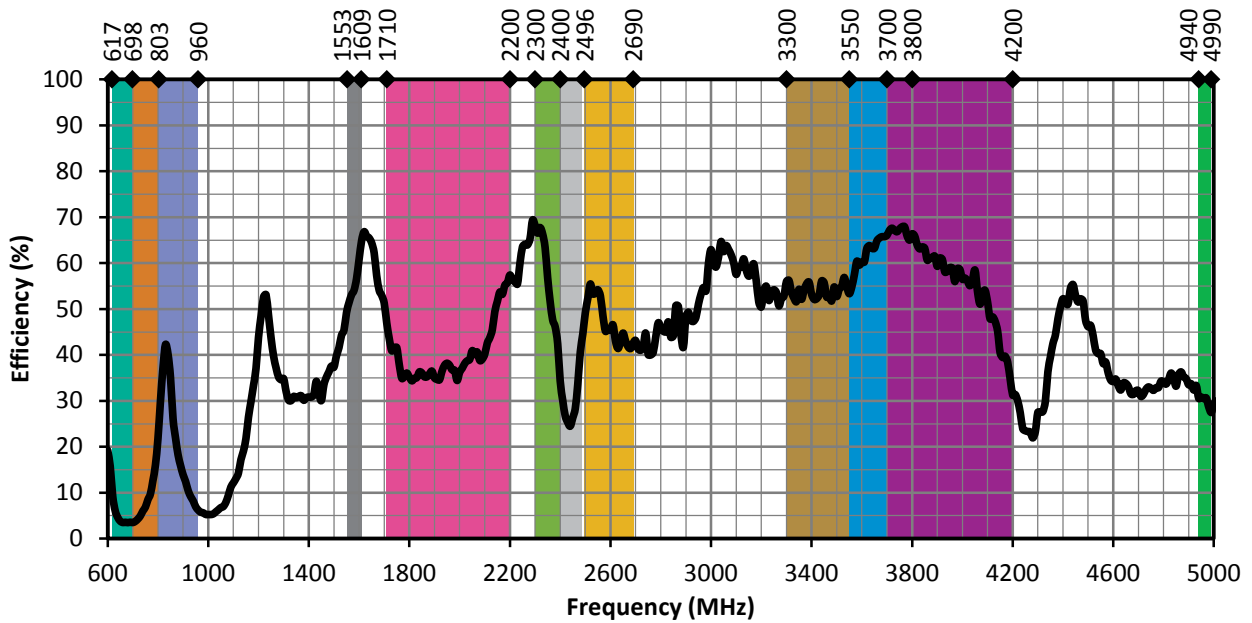
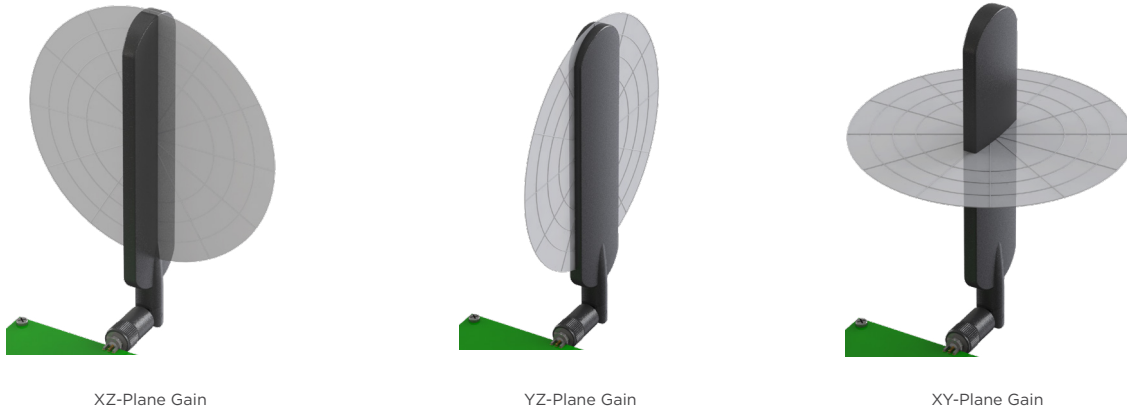

Figure 15. ANT-5GWWS2-SMA Antenna Efficiency, Edge-Bent

RADIATION PATTERNS

Radiation patterns provide information about the directionality and 3-dimensional gain performance of the antenna by plotting gain at specific frequencies in three orthogonal planes. Antenna radiation patterns for an Edge-Bent orientation are shown in Figure 16 using polar plots covering 360 degrees. The antenna graphic at the top of the page provides reference to the plane of the column of plots below it. Note: when viewed with typical PDF viewing software, zooming into radiation patterns is possible to reveal fine detail.

RADIATION PATTERNS - EDGE-BENT



617 MHz TO 698 MHz (660 MHz)

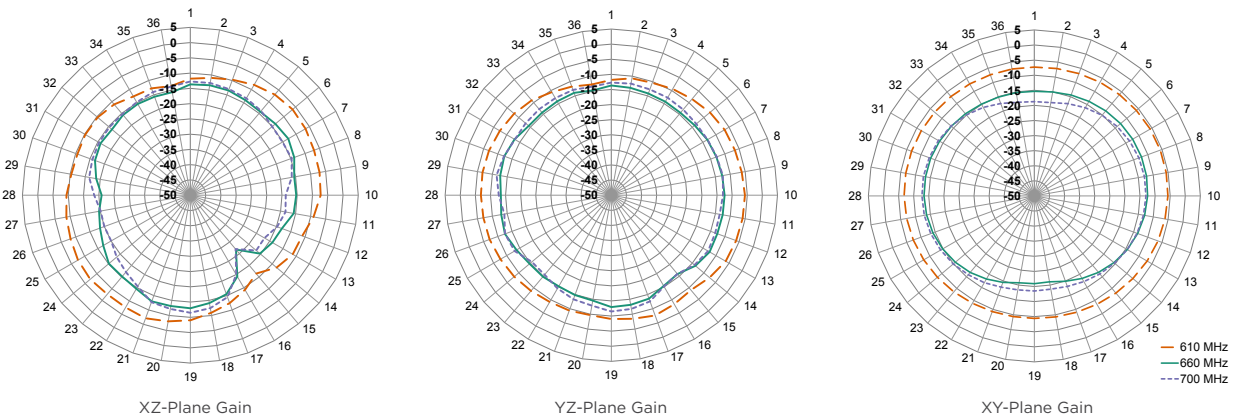

698 MHz TO 803 MHz (750 MHz)

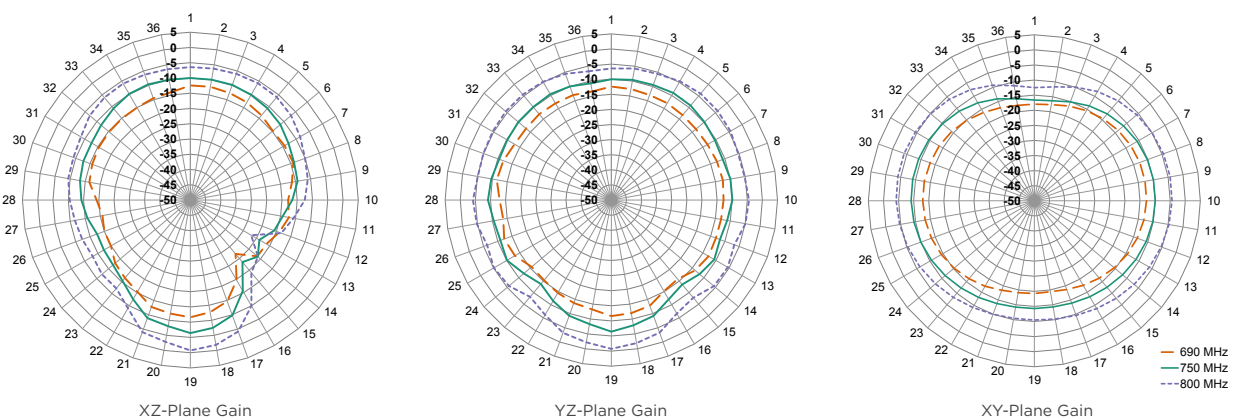
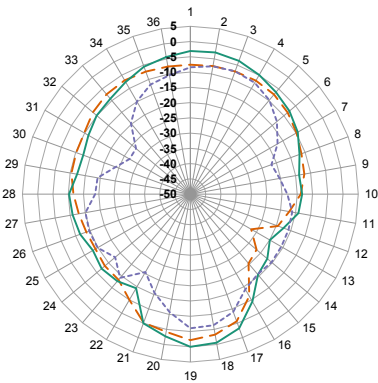

Figure 16. Radiation Patterns for ANT-8/9-IPW1-SMA, Straight

RADIATION PATTERNS - EDGE-BENT

791 MHz TO 960 MHz (870 MHz)



XZ-Plane Gain

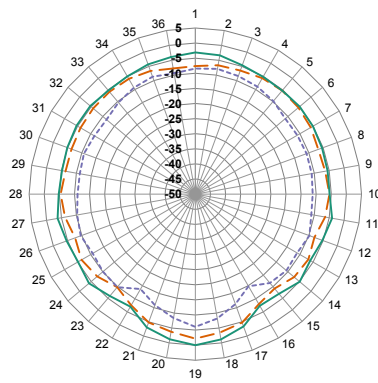

YZ-Plane Gain

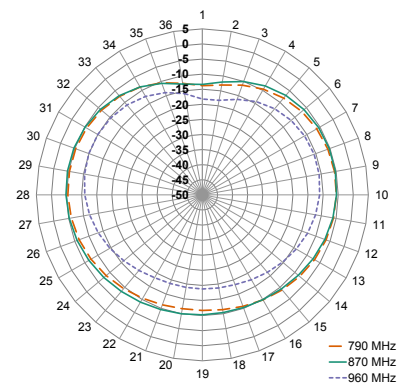

XY-Plane Gain

— 790 MHz
— 870 MHz
- - 960 MHz

1710 MHz TO 2200 MHz (1950 MHz)

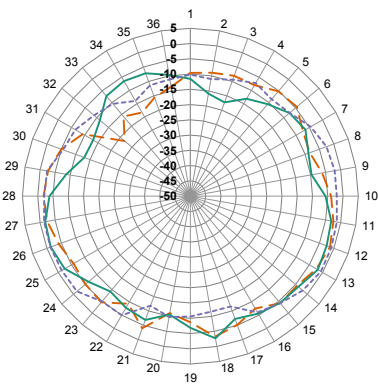

XZ-Plane Gain

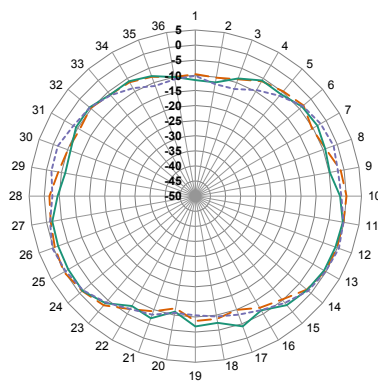

YZ-Plane Gain

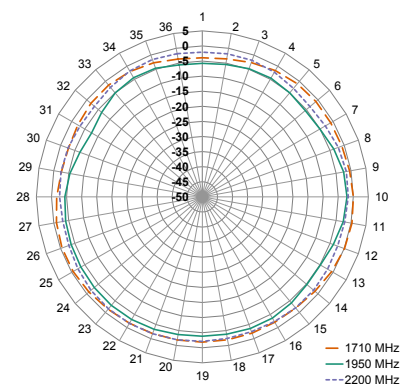

XY-Plane Gain

— 1710 MHz
— 1950 MHz
- - 2200 MHz

2300 MHz TO 2400 MHz (2350 MHz)

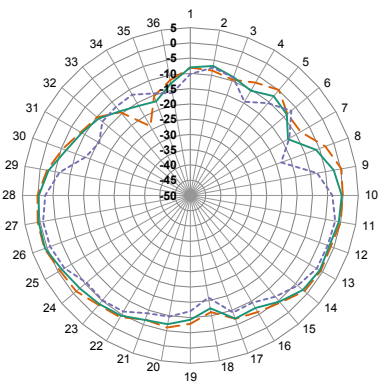

XZ-Plane Gain

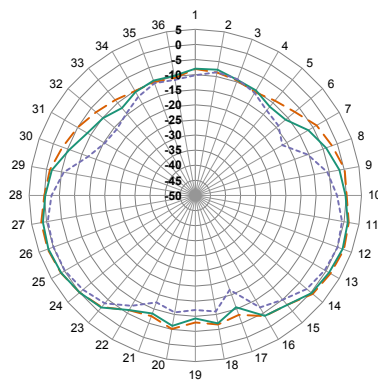

YZ-Plane Gain

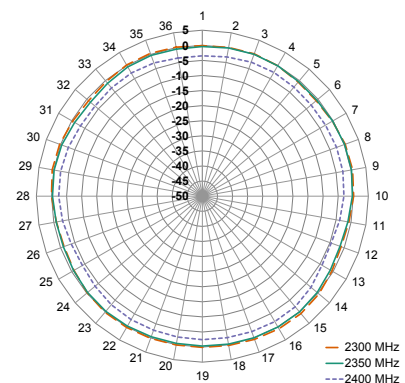

XY-Plane Gain

— 2300 MHz
— 2350 MHz
- - 2400 MHz

RADIATION PATTERNS - EDGE-BENT

2496 MHz TO 2690 MHz (3620 MHz)

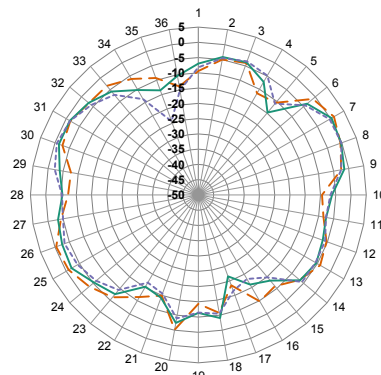

XZ-Plane Gain

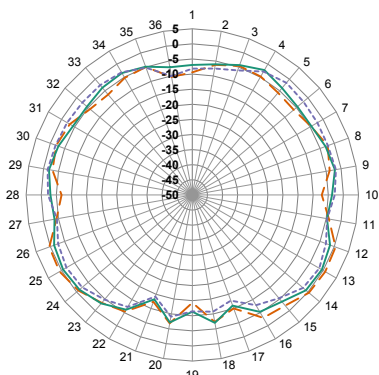

YZ-Plane Gain

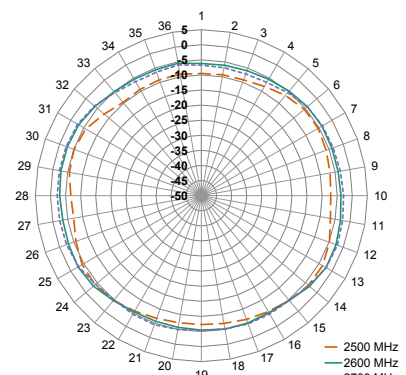

XY-Plane Gain

3300 MHz TO 3800 MHz (3550 MHz)

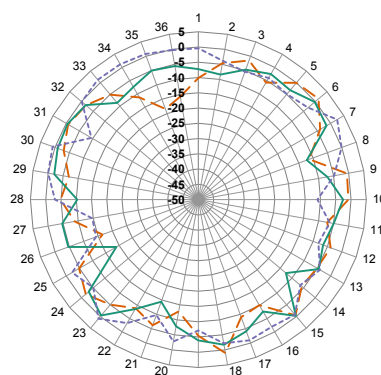

XZ-Plane Gain

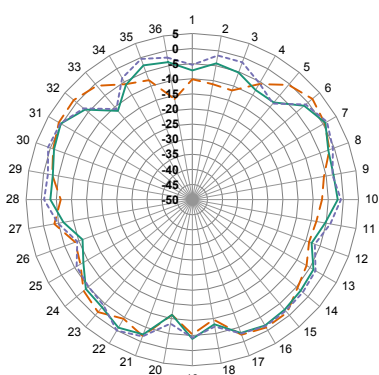

YZ-Plane Gain

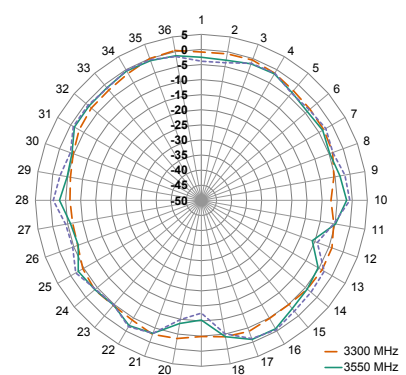

XY-Plane Gain

1553 MHz TO 1609 MHz (1580 MHz)

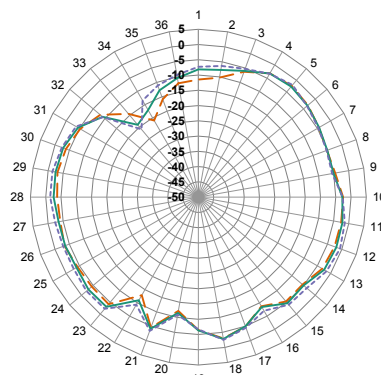

XZ-Plane Gain

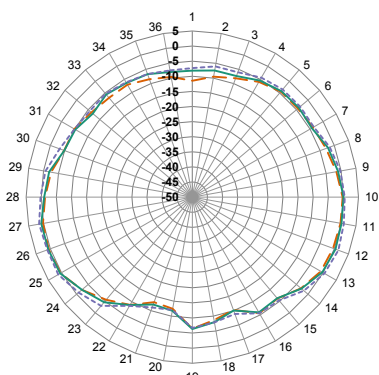

YZ-Plane Gain

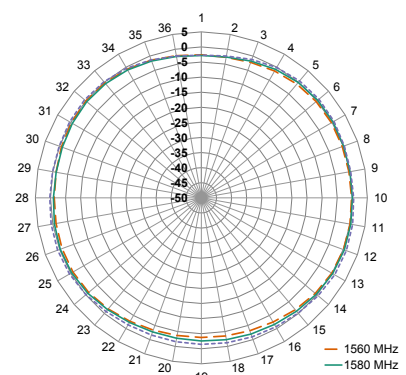

XY-Plane Gain

RADIATION PATTERNS - EDGE-BENT

2400 MHz TO 2485 MHz (2450 MHz)

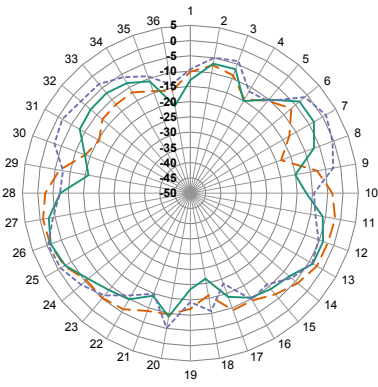

XZ-Plane Gain

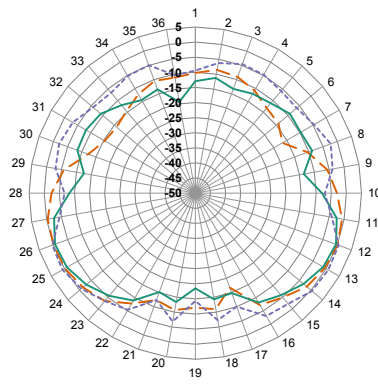

YZ-Plane Gain

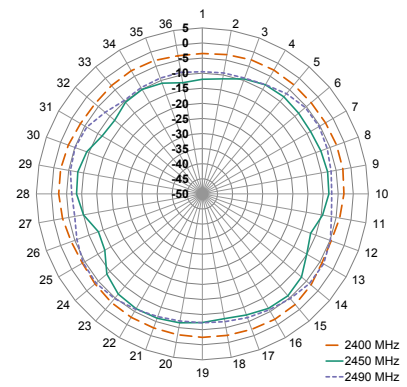

XY-Plane Gain

— 2400 MHz
— 2450 MHz
- - 2490 MHz

3550 MHz TO 3700 MHz (3620 MHz)

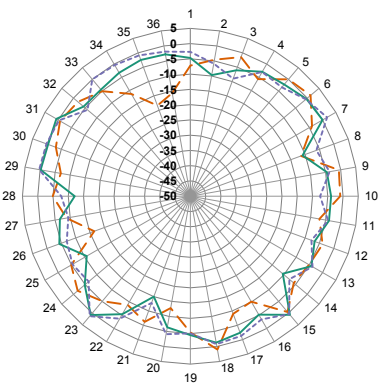

XZ-Plane Gain

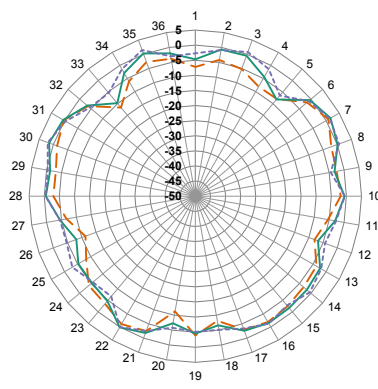

YZ-Plane Gain

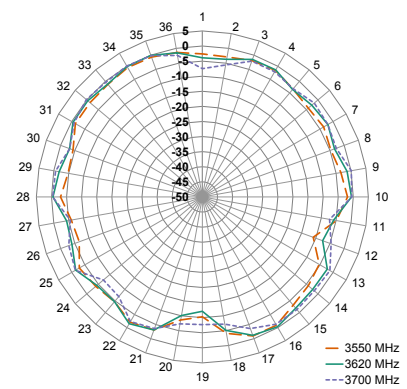

XY-Plane Gain

— 3550 MHz
— 3620 MHz
- - 3700 MHz

3700 MHz TO 4200 MHz (3950 MHz)

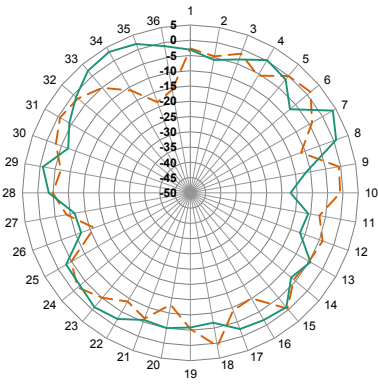

XZ-Plane Gain

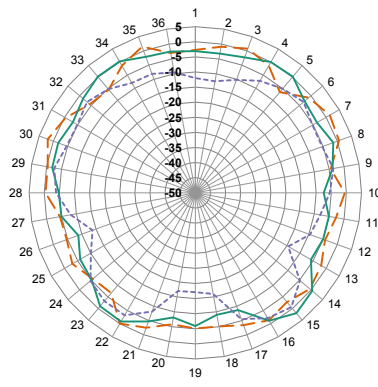

YZ-Plane Gain

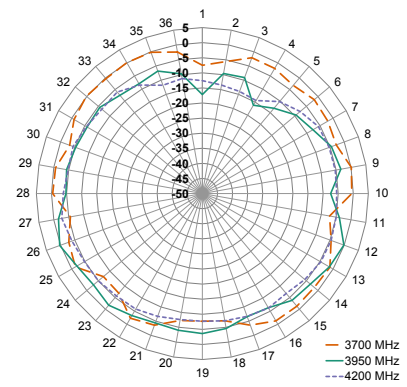

XY-Plane Gain

— 3700 MHz
— 3950 MHz
- - 4200 MHz

RADIATION PATTERNS - EDGE-BENT

2400 MHz TO 2485 MHz (2450 MHz)

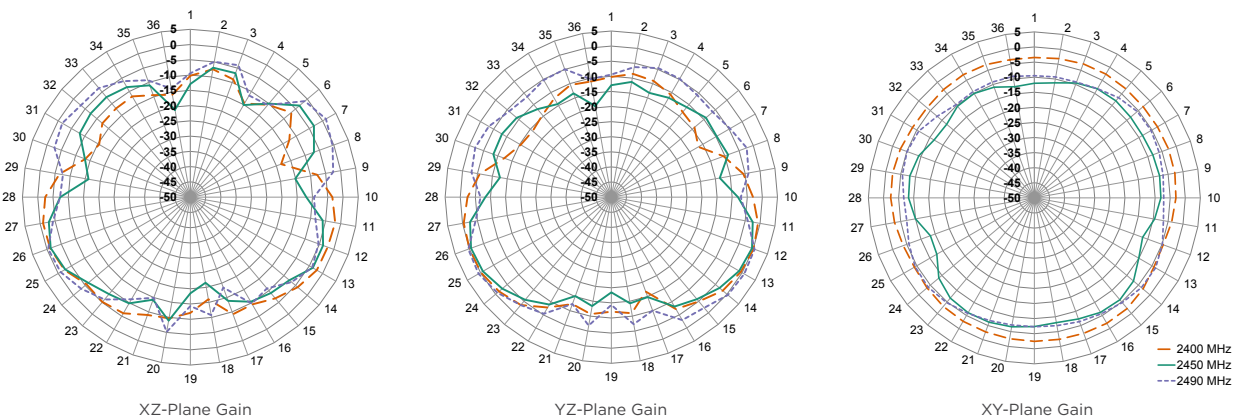

Figure 16. Radiation Patterns for ANT-8/9-IPW1-SMA, Straight

TE TECHNICAL SUPPORT CENTER

USA:	+1 (800) 522-6752
Canada:	+1 (905) 475-6222
Mexico:	+52 (0) 55-1106-0800
Latin/S. America:	+54 (0) 11-4733-2200
Germany:	+49 (0) 6251-133-1999
UK:	+44 (0) 800-267666
France:	+33 (0) 1-3420-8686
Netherlands:	+31 (0) 73-6246-999
China:	+86 (0) 400-820-6015

te.com

TE Connectivity, TE, TE connectivity (logo), Linx and Linx Technologies are trademarks owned or licensed by the TE Connectivity Ltd. family of companies. All other logos, products and/or company names referred to herein might be trademarks of their respective owners.

The information given herein, including drawings, illustrations and schematics which are intended for illustration purposes only, is believed to be reliable. However, TE Connectivity makes no warranties as to its accuracy or completeness and disclaims any liability in connection with its use. TE Connectivity's obligations shall only be as set forth in TE Connectivity's Standard Terms and Conditions of Sale for this product and in no case will TE Connectivity be liable for any incidental, indirect or consequential damages arising out of the sale, resale, use or misuse of the product. Users of TE Connectivity products should make their own evaluation to determine the suitability of each such product for the specific application.

TE Connectivity warrants to the original end user customer of its products that its products are free from defects in material and workmanship. Subject to conditions and limitations TE Connectivity will, at its option, either repair or replace any part of its products that prove defective because of improper workmanship or materials. This limited warranty is in force for the useful lifetime of the original end product into which the TE Connectivity product is installed. Useful lifetime of the original end product may vary but is not warranted to exceed one (1) year from the original date of the end product purchase.

©2022 TE Connectivity. All Rights Reserved.

09/22 Original