

HumPRO™ Series 868MHz RF Transceiver Module Data Guide

Wireless made simple®

Warning: Some customers may want Linx radio frequency (“RF”) products to control machinery or devices remotely, including machinery or devices that can cause death, bodily injuries, and/or property damage if improperly or inadvertently triggered, particularly in industrial settings or other applications implicating life-safety concerns (“Life and Property Safety Situations”).

NO OEM LINX REMOTE CONTROL OR FUNCTION MODULE SHOULD EVER BE USED IN LIFE AND PROPERTY SAFETY SITUATIONS. No OEM Linx Remote Control or Function Module should be modified for Life and Property Safety Situations. Such modification cannot provide sufficient safety and will void the product’s regulatory certification and warranty.

Customers may use our (non-Function) Modules, Antenna and Connectors as part of other systems in Life Safety Situations, but only with necessary and industry appropriate redundancies and in compliance with applicable safety standards, including without limitation, ANSI and NFPA standards. It is solely the responsibility of any Linx customer who uses one or more of these products to incorporate appropriate redundancies and safety standards for the Life and Property Safety Situation application.

Do not use this or any Linx product to trigger an action directly from the data line or RSSI lines without a protocol or encoder/decoder to validate the data. Without validation, any signal from another unrelated transmitter in the environment received by the module could inadvertently trigger the action.

All RF products are susceptible to RF interference that can prevent communication. RF products without frequency agility or hopping implemented are more subject to interference. This module does have a frequency hopping protocol built in, but the developer should still be aware of the risk of interference.

Do not use any Linx product over the limits in this data guide. Excessive voltage or extended operation at the maximum voltage could cause product failure. Exceeding the reflow temperature profile could cause product failure which is not immediately evident.

Do not make any physical or electrical modifications to any Linx product. This will void the warranty and regulatory and UL certifications and may cause product failure which is not immediately evident.

Table of Contents

1	Description
1	Features
2	Ordering Information
2	Absolute Maximum Ratings
3	Electrical Specifications
5	Typical Performance Graphs
10	Pin Assignments
10	Pin Descriptions
12	Encapsulated Module Pin Assignments
13	Module Dimensions
14	Theory of Operation
15	Module Description
16	Overview
18	Addressing Modes
20	Automatic Addressing
20	Address Register Use
21	Acknowledgements and Assured Delivery
22	Listen Before Talk and Adaptive Frequency Agility
26	Transmitting Packets
27	Receiving Packets
31	Using the Buffer Empty (BE) Line
32	Exception Engine
34	Networking
35	Using the Command Response ($\overline{\text{CRESP}}$) Line
36	Using the $\overline{\text{CMD}}$ Line
36	External Amplifier Control
37	AES Encryption
40	Using the MODE_IND Line
41	Using the PB Line

42	Restore Factory Defaults
42	Using the Low Power Features
44	The Command Data Interface
45	Reading from Registers
46	Writing to Registers
47	Command Length Optimization
48	Example Code for Encoding Read/Write Commands
50	The Command Data Interface Command Set
97	Typical Applications
98	Power Supply Requirements
98	Antenna Considerations
99	Interference Considerations
100	Pad Layout
101	Microstrip Details
102	Board Layout Guidelines
103	Helpful Application Notes from Linx
104	Production Guidelines
104	Hand Assembly
104	Automated Assembly
106	General Antenna Rules
108	Common Antenna Styles
110	Regulatory Considerations

HumPRO™ Series 868MHz RF Transceiver Module

Data Guide

Description

The HumPRO™ Series is an RF transceiver designed for the reliable transfer of digital data. It incorporates a Listen Before Talk (LBT) and Adaptive Frequency Agility (AFA) algorithm that meets the ETSI requirements for 64% duty cycle transmissions in the 868MHz band. It has a very fast lock time so that it can quickly wake up, send data and go back to sleep, saving power in battery-powered applications.

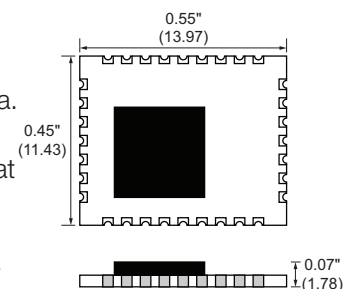

Figure 1: Package Dimensions

The module has several features that increase the data transfer reliability. It ensures that no other modules are transmitting before it begins transmitting data. Automatic acknowledgements ensure that the remote side received valid data. Multiple hopping patterns enable several systems to operate in proximity without interference. A standard UART interface is used for module configuration and data transfer. A few simple serial commands are all that are needed for configuration.

All modules have a unique 32-bit serial number that can be used as an address. Source and destination addressing support point-to-point and broadcast links. Address masking by the receiving module allows for creating subnets. Other network topologies can also be implemented.

Housed in a tiny compact reflow-compatible SMD package, the transceiver requires no external RF components except an antenna, which greatly simplifies integration and lowers assembly costs.

Features

- LBT + AFA Algorithm
- Fast Lock (<30ms at 115kbps)
- Low power modes
- Simple UART interface
- No external RF components required
- No production tuning required
- Tiny PLCC-32 footprint

Ordering Information

Ordering Information	
Part Number	Description
HUM-868-PRO	868MHz HumPRO™ Series Data Transceiver
HUM-868-PRO-CAS	HumPRO™ Series Data Transceiver with Castellation Connection
HUM-868-PRO-UFL	HumPRO™ Series Data Transceiver with u.FL Connector
EVM-868-PRO	868MHz HumPRO™ Series Carrier Board
MDEV-868-PRO	868MHz HumPRO™ Series Master Development System

Figure 2: Ordering Information

Absolute Maximum Ratings

Absolute Maximum Ratings				
Supply Voltage V_{CC}	-0.3	to	+3.9	VDC
Any Input or Output Pin	-0.3	to	$V_{CC} + 0.3$	VDC
RF Input		0		dBm
Operating Temperature	-40	to	+85	°C
Storage Temperature	-40	to	+85	°C

Exceeding any of the limits of this section may lead to permanent damage to the device. Furthermore, extended operation at these maximum ratings may reduce the life of this device.

Figure 3: Absolute Maximum Ratings

 **Warning:** This product incorporates numerous static-sensitive components. Always wear an ESD wrist strap and observe proper ESD handling procedures when working with this device. Failure to observe this precaution may result in module damage or failure.

Electrical Specifications

HumPRO™ Series Transceiver Specifications						
Parameter	Symbol	Min.	Typ.	Max.	Units	Notes
Power Supply						
Operating Voltage	V_{CC}	2.0		3.6	VDC	
TX Supply Current	I_{CCTX}					
at +10dBm			40.5		mA	1,2
at 0dBm			22		mA	1,2
RX Supply Current	I_{CCRX}		23.5		mA	1,2,3
Power-Down Current	I_{PDN}		0.7		μA	1,2
RF Section						
Operating Frequency Band	F_C	863		870	MHz	
Number of hop channels			70			
Channel spacing			100		kHz	
20 dB OBW			48		kHz	
Receiver BW			102		kHz	
FSK deviation			± 14		kHz	
Scan time / channel (avg)			0.91		ms	
Channel Lock time			76		ms	
RF Data Rate			38.4		kbps	
Modulation			GFSK			
Data Encoding			6/7 RLL			
Number of Hop Sequences			6			
Receiver Section						
Spurious Emissions				-47	dBm	
IF Frequency			330.078		kHz	
Receiver Sensitivity		-97	-100		dBm	5
RSSI Dynamic Range			85		dB	
Transmitter Section						
Max Output Power	P_O	+8.5	+10.6		dBm	6
Harmonic Emissions	P_H		-41		dBc	6
Output Power Range		-5		9	dB	6
Antenna Port						
RF Impedance	R_{IN}		50		Ω	4
Environmental						
Operating Temp. Range		-40		+85	°C	4

HumPRO™ Series Transceiver Specifications						
Parameter	Symbol	Min.	Typ.	Max.	Units	Notes
Timing						
Module Turn-On Time						
Via V_{CC}		71		190	ms	4
Via POWER_DOWN		4.00		4.12	ms	4
Via Standby			4.12		ms	4
Serial Command Response						
Volatile R/W			0.4	5	ms	8
NV Update			2.4	31.5	ms	8
Factory Reset		199		484	ms	14
Channel Dwell Time				400	ms	
CMD low to trigger TX with option TXnCMD	t_{TXnCMD}	2			ms	13
Interface Section						
UART Data rate		9,600		115,200	bps	
Input						
Logic Low	V_{IL}			$0.3 \cdot V_{CC}$	VDC	
Logic High	V_{IH}	$0.7 \cdot V_{CC}$			VDC	
Output						
Logic Low, MODE_IND, BE	V_{OLM}			$0.3 \cdot V_{CC}$	VDC	1,9
Logic High, MODE_IND, BE	V_{OHM}	$0.7 \cdot V_{CC}$			VDC	1,9
Logic Low	V_{OL}			$0.3 \cdot V_{CC}$		1,10
Logic High	V_{OH}	$0.7 \cdot V_{CC}$				1,10
CRESP Hold Time		10			Bits	11
Flash (Non-Volatile) Memory Specifications						
Flash Write Bytes		16,000			bytes	12
Flash Refresh Cycles		2,000			cycles	
1.	Measured at 3.3V V_{CC}		9.	60mA source/sink		
2.	Measured at 25°C		10.	6mA source/sink		
3.	Input power < -60dBm		11.	End of CMD_DATA_OUT stop bit to change in CRESP		
4.	Characterized but not tested		12.	Number of register write operations		
5.	PER = 1%		13.	With CSMA disabled		
6.	Into a 50-ohm load		14.	Start of factory reset command to end of last ACK response		
7.	No RF interference					
8.	From end of command to start of response					

Figure 4: Electrical Specifications

Typical Performance Graphs

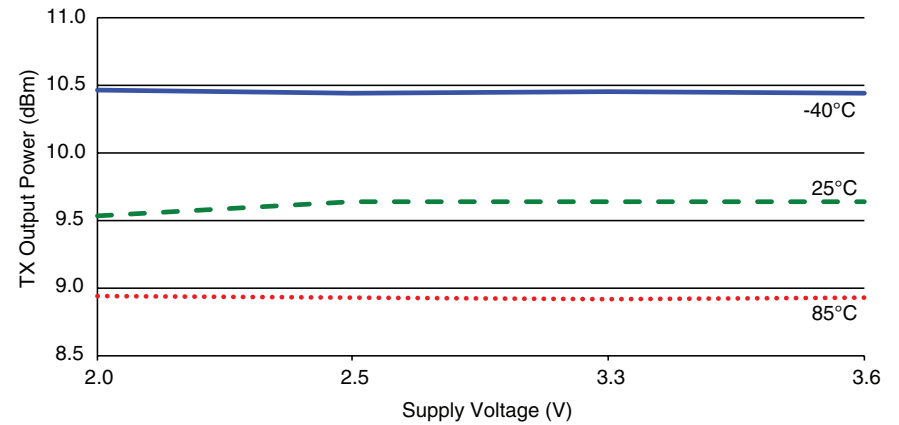

Figure 5: HumPRO™ Series Transceiver Max Output Power vs. Supply Voltage - HUM-868-PRO

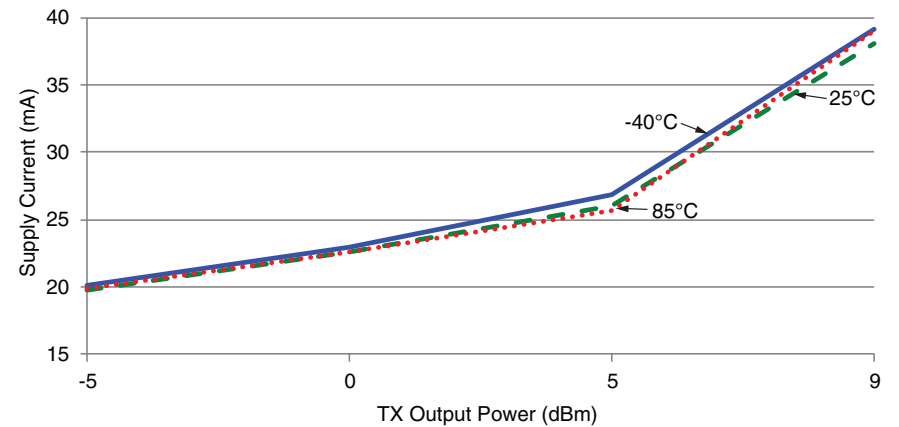

Figure 6: HumPRO™ Series Transceiver Average Current vs. Transmitter Output Power at 2.5V - HUM-868-PRO

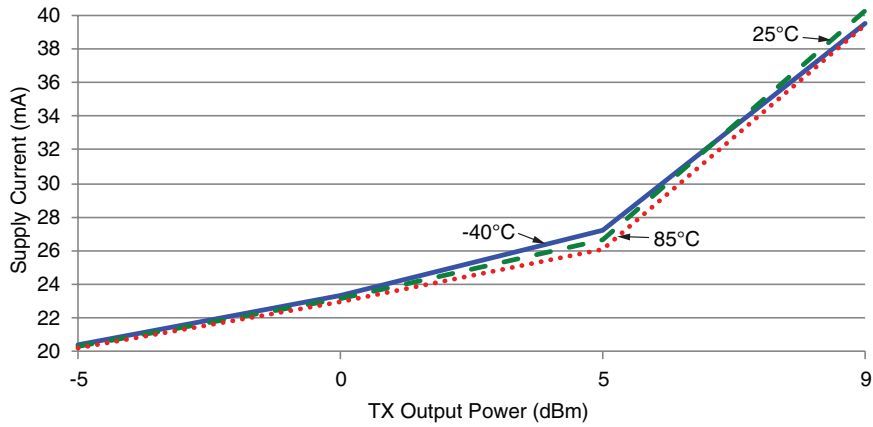

Figure 8: HumPRO™ Series Transceiver Average TX Current vs. Transmitter Output Power at 3.3V - HUM-868-PRO

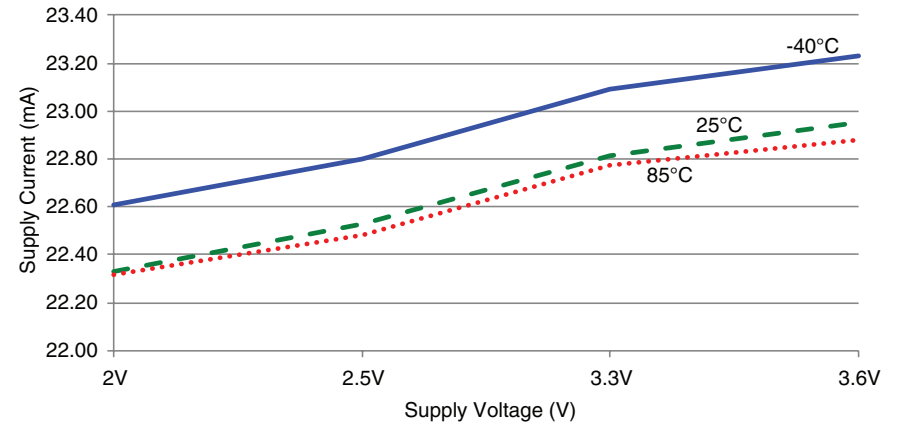

Figure 9: HumPRO™ Series Transceiver TX Current vs. Supply Voltage at 0dBm - HUM-868-PRO

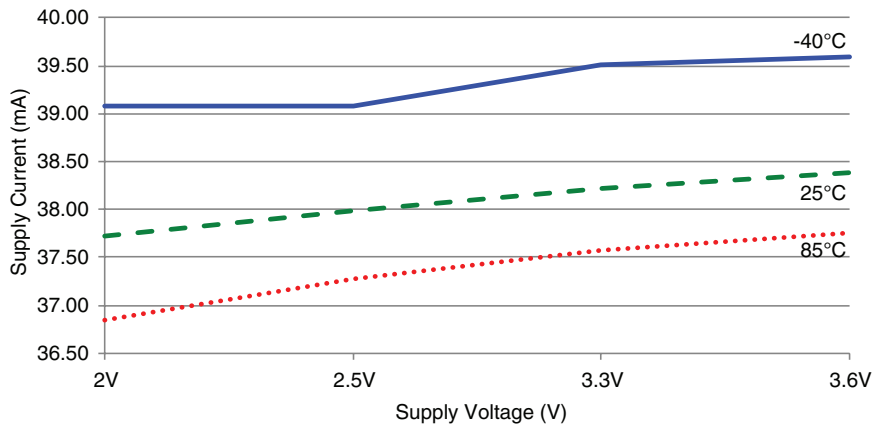

Figure 7: HumPRO™ Series Transceiver TX Current vs. Supply Voltage at Max Power - HUM-868-PRO

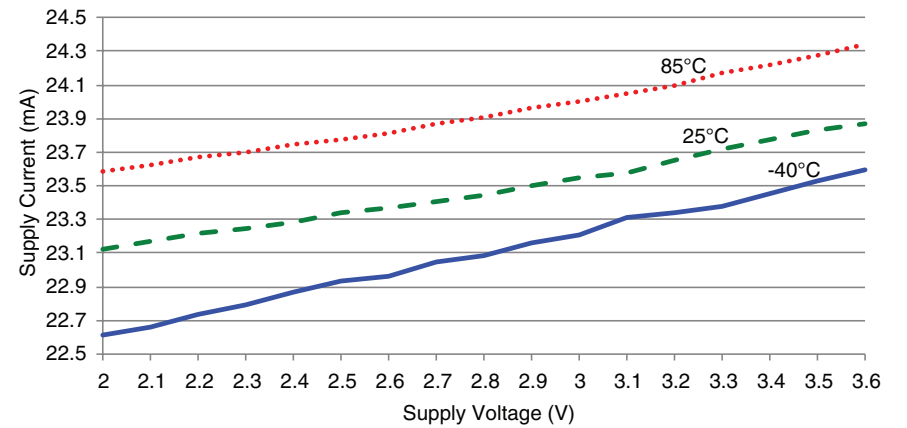

Figure 10: HumPRO™ Series Transceiver RX Scan Current vs. Supply Voltage, 9.6kbps - HUM-868-PRO

Current consumption while the module is scanning for a transmission. The current is approximately 0.5mA higher when receiving data at 9.6kbps.

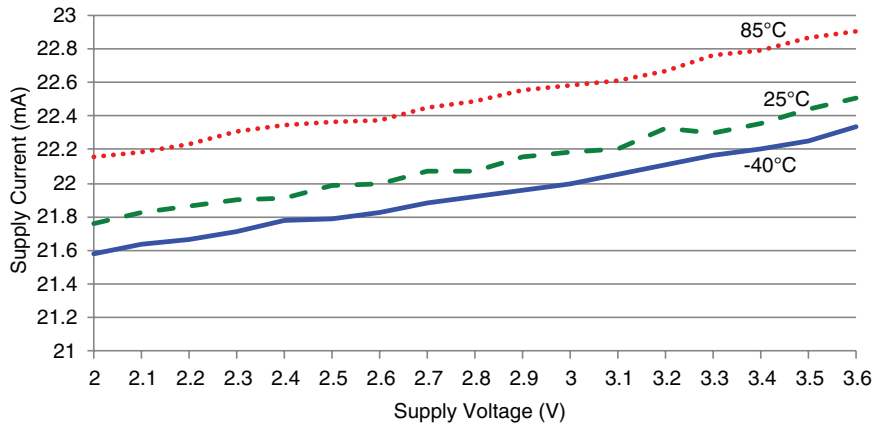

Figure 12: HumPRO™ Series Transceiver RX Scan Current vs. Supply Voltage, 115.2kbps - HUM-868-PRO

Current consumption while the module is scanning for a transmission. The current is approximately 2mA higher when receiving data at 115.2kbps.

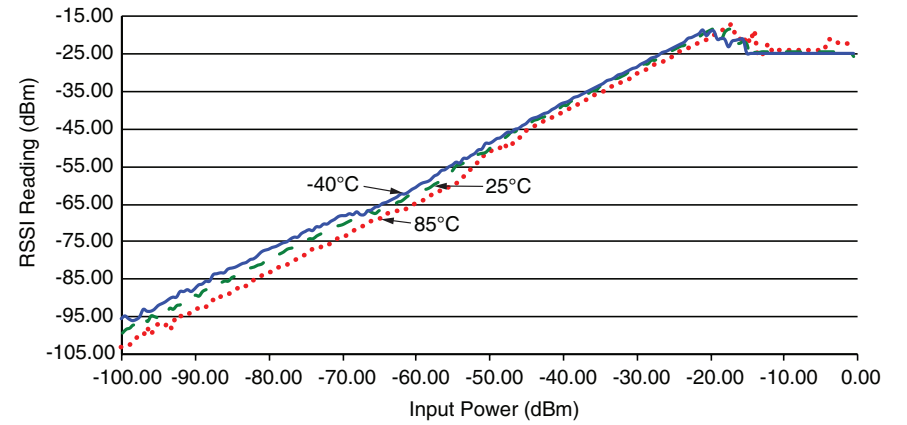

Figure 13: HumPRO™ Series Transceiver RSSI Voltage vs. Input Power - HUM-868-PRO

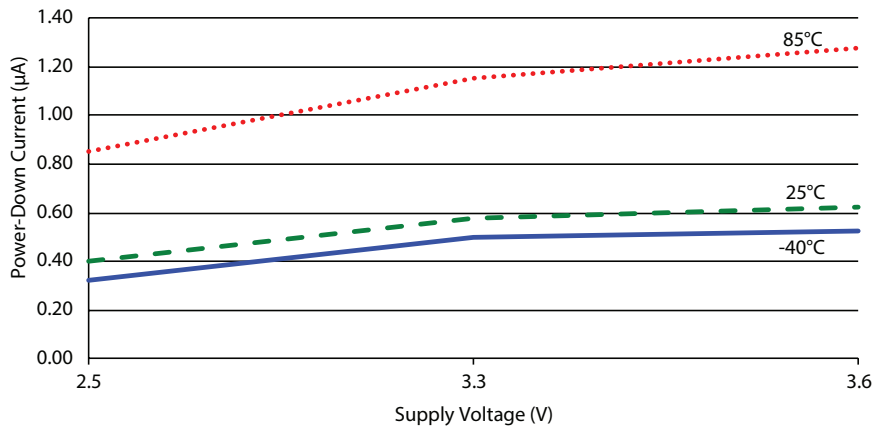

Figure 11: HumPRO™ Series Transceiver Standby Current Consumption vs. Supply Voltage - HUM-868-PRO

Pin Assignments

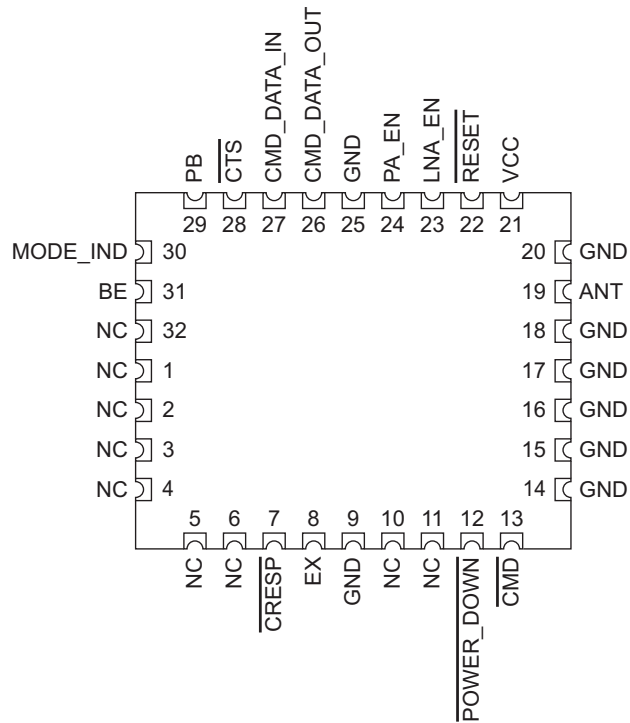

Figure 14: HumPRO™ Series Transceiver Pin Assignments (Top View)

Pin Descriptions

Pin Descriptions			
Pin Number	Name	I/O	Description
1, 2, 3, 4, 5, 6, 10, 11, 32	NC	—	No Electrical Connection. Do not connect any traces to these lines.
7	$\overline{\text{CRESP}}$	O	Command Response. This line is low when the data on the CMD_DATA_OUT line is a response to a command and not data received over the air.
8	EX	O	Exception Output. A mask can be set to take this line high when an exception occurs.
9, 14, 15, 16, 17, 18, 20, 25	GND	—	Ground
12	$\overline{\text{POWER_DOWN}}$	I	Power Down. Pulling this line low places the module into a low-power state. The module is not functional in this state. Pull high for normal operation. Do not leave floating.

Pin Descriptions			
Pin Number	Name	I/O	Description
13	$\overline{\text{CMD}}$	I	Command Input. When this line is low, incoming bytes are command data. When high, incoming bytes are data to be transmitted.
19	ANTENNA	—	50-ohm RF Antenna Port
21	VCC	—	Supply Voltage
22	$\overline{\text{RESET}}$	I	This line resets the module when pulled low. It should be high for normal operation. This line has an internal 10k resistor to supply, so leave it unconnected if not used.
23	LNA_EN	O	Low Noise Amplifier Enable. This line is driven high when receiving. It is intended to activate an optional external LNA.
24	PA_EN	O	Power Amplifier Enable. This line is driven high when transmitting. It is intended to activate an optional external power amplifier.
26	CMD_DATA_OUT	O	Command Data Out. Output line for data and serial commands
27	CMD_DATA_IN	I	Command Data In. Input line for data ($\overline{\text{CMD}}$ is high) and serial commands ($\overline{\text{CMD}}$ is low).
28	$\overline{\text{CTS}}$	O	UART Clear To Send, active low. This line indicates to the host microcontroller when the module is ready to accept data. When $\overline{\text{CTS}}$ is high, the module is busy. When $\overline{\text{CTS}}$ is low, the module is ready for data.
29	PB	I	Push Button input. This line can be connected to Vcc through a normally open push button. Button sequences can reset configurations to default and join modules into a network. Pull low when not in use; do not leave floating.
30	MODE_IND	O	Mode Indicator. This line indicates module activity. It can source enough current to drive a small LED, causing it to flash. The duration of the flashes indicates the module's current state.
31	BE	O	Buffer Empty. This line is high when the UART input buffer is empty, indicating that all data has been transmitted. If acknowledgment is active, it also indicates that the receiving module has acknowledged the data or a retry exception has occurred.

Figure 15: HumPRO™ Series Transceiver Pin Descriptions

Encapsulated Module Pin Assignments

The encapsulated version of the module has mostly the same pin assignments as the standard version. The antenna connection is routed to either a castellation (-CAS) or a u.FL connector (-UFL), depending on the part number ordered.

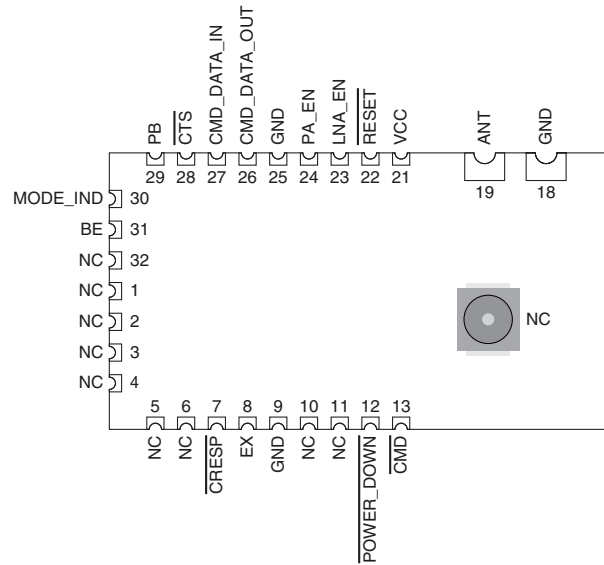

Figure 16: HumPRO™ Series Transceiver Encapsulated Version Pin Assignments - Castellation Connection (Top View)

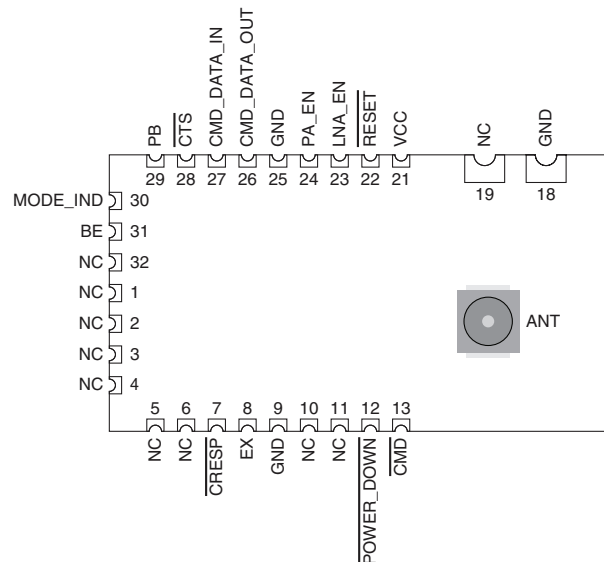

Figure 17: HumPRO™ Series Transceiver Encapsulated Version Pin Assignments - UFL Connection (Top View)

Module Dimensions

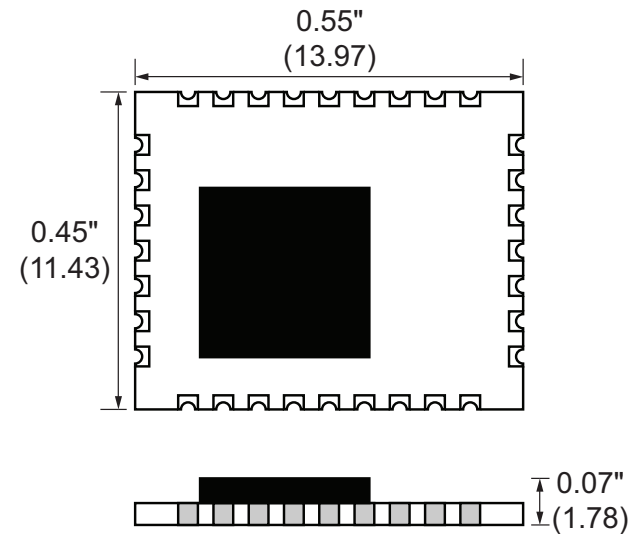

Figure 18: HumPRO™ Series Transceiver Dimensions

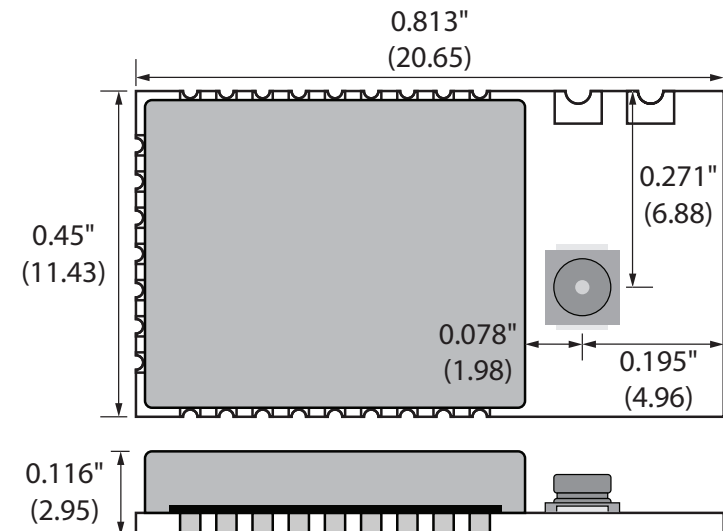

Figure 19: HumPRO™ Series Transceiver Encapsulated Version Dimensions

Theory of Operation

The HumPRO™ Series transceiver is a low-cost, high-performance synthesized FSK / GFSK / MSK transceiver. Figure 20 shows the module's block diagram.

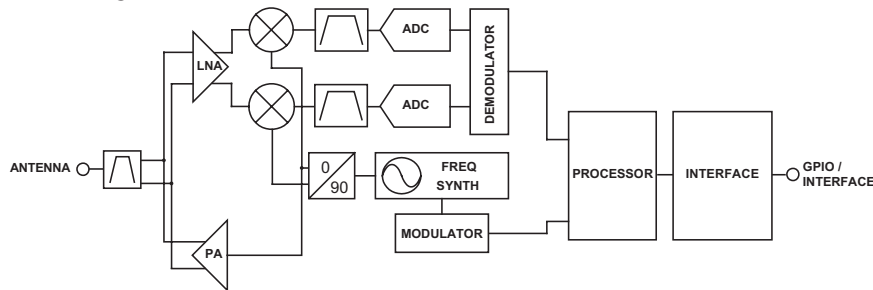

Figure 20: HumPRO™ Series Transceiver RF Section Block Diagram

The HumPRO™ Series transceiver operates in the 863 to 870MHz frequency band. The transmitter output power is programmable. The range varies depending on the antenna implementation and the local RF environment.

The RF carrier is generated directly by a frequency synthesizer that includes an on-chip VCO. The received RF signal is amplified by a low noise amplifier (LNA) and down-converted to I/Q quadrature signals. The I/Q signals are digitized by ADCs.

A low-power onboard communications processor performs the radio control and management functions including Automatic Gain Control (AGC), filtering, demodulation and packet synchronization. A control processor performs the higher level functions and controls the serial and hardware interfaces.

A crystal oscillator generates the reference frequency for the synthesizer and clocks for the ADCs and the processor.

Module Description

The HumPRO™ Series module is a completely integrated RF transceiver and processor designed to transmit digital data across a wireless link. It employs an LBT and AFA system for noise immunity and higher transmitter duty cycle as allowed by government regulations.

When the module does not have data to send it scans all of the channels for incoming data. If it finds a valid preamble, it pauses and looks for the start of a packet. When it receives a valid packet with a matching destination address the module outputs the data through the UART.

The transmitting module accepts data bytes through its UART until a configurable number of bytes is reached or a configurable timeout expires between bytes on the UART. At this point the module transmits the packet.

When the module has data to send it measures the RSSI on the selected channel to ensure that the channel is clear. If the RSSI check passes, then it transmits the packets. If the RSSI fails, then it implements a random wait time and tries again. When the channel is clear, the module transmits the data.

The module can stay on one channel for up to 400ms. If the module is ready to start transmitting near the end of the channel time, it transmits the number of bytes that it can in the remaining time. It then hops to the next channel in its hopping pattern to transmit the remaining data.

The module supports automatic acknowledgements for assured delivery. When enabled, the receiving module responds to a valid transmission with an acknowledgement to let the transmitting module know that it received the data. If an acknowledgement is not received then the transmitting module repeats the transmission for a configurable number of retries. If the retry limit is exceeded without an acknowledgement then the transmitting module issues an exception error to let the host micro know of the communication problem.

A standard UART interface is used to configure the module for operation and for the data input and output. This is suitable for direct connection to UARTs on many microcontrollers, USB converters and RS-232 converters. A simple command set is used for configuration and control.

Modules can be pre-configured for fixed point-to-point or broadcast topologies allowing streaming data (no commands) during operation.

Overview

The HumPRO™ Series RF transceiver module offers a number of features that make it suitable for many data transfer applications. This section provides a basic overview of the features while following sections dive into them in more detail.

Addressing

The modules have a very powerful addressing method. Each module is given a unique 16 or 32 bit address. The receiving modules use an address mask that determines how it responds to a received transmission.

The addressing and masking allow for the creation of point-to-point, many-to-one and one-to-many wireless links. This allows the creation of many network topologies, such as star, tree and mesh. The routing for the network topology is managed outside the module.

The addressing is the primary configuration when getting started with the modules. RG-00105, the HumPRO™ Addressing Mode Reference Guide has details about configuring the addressing.

Acknowledgements and Assured Delivery

The modules support assured delivery in the form of acknowledgements and retries. When the acknowledgements are enabled, the receiving device sends an acknowledge message to let the sender know that the transmission was received. If the sender does not get an acknowledgement it resends the message up to a configurable number of retries. If there is still no acknowledgement, the module triggers an exception to let the host processor know of the error.

Command Mode and Data Mode

The module has two main interface modes controlled by the state of the $\overline{\text{CMD}}$ line. Command mode routes the data coming in on the CMD_DATA_IN line to the processor for configuring the module. Data mode routes the data to the transmitter for transmission over-the-air. The $\overline{\text{CMD}}$ line is normally controlled by an external microcontroller.

Encryption

The module supports AES-128 encryption to provide a secure wireless link. All of the modules must have encryption enabled and be using the same key in order for communication to be successful. There are two ways of entering an encryption key: directly by writing the key to registers through the Command Data Interface or through a JOIN process.

Streaming Data and Explicit Packets

The module's default configuration is for streaming data. At some UART rates the module sends the data at a higher rate over-the-air than it is input on the UART. This hides the time required for the protocol transactions as well as the LBT and AFA. The result is that the data appears to stream through the module with no breaks in the data apparent to the host processor.

Alternatively, the module can be configured for explicit packet transmission. This allows the host processor to control when packets are sent and what data is in each packet

Exceptions and Host Processor Interface

The module has several indicator lines that provide feedback to the host processor on the module's operation and current status. This includes an exception line (EX) that informs the processor when errors occur so that it can take steps to manage the issue gracefully. The state of the status lines can also be read through the module's Command Data Interface to reduce the number of hardware connections that are required.

Command Data Interface

The module has a Command Data Interface that consists of a set of serial commands entered through a UART. These are shorter and simpler than AT commands that are popular with many modules. These commands control the configuration of the module as well as allow feedback on the operation and status of the module.

Listen Before Talk and Adaptive Frequency Agility

The module implements a Carrier Sense Multiple Access method. It listens to the channel and makes sure that it is clear before it transmits. If the channel is in use, the module either waits for it to clear or hops to the next channel depending on its current state. This reduces the overall potential for interference and improves the robustness of the link.

The module provides short pauses between packets to comply with ETSI LBT regulations. It optionally provides additional pauses to limit hourly channel usage limits to ETSI regulations.

Addressing Modes

The module has very flexible addressing methods selected with the **ADDMODE** register. It can be changed during operation. The transmitting module addresses packets according to the addressing mode configuration. The receiving module processes all addressing types regardless of the **ADDMODE** configuration. If the received message matches the addressing criteria, it is output on the UART. Otherwise it is discarded. The **ADDMODE** configuration also enables assured delivery.

There are three addressing modes: DSN, User and Extended User. Each mode offers different communications methods, but all use source and destination addressing. The source address is for the transmitting unit, the destination address is the intended receiver. Each mode uses different registers for the source and destination addresses.

The following sections give brief descriptions of the three modes, but a detailed explanation and examples are given in RG-00105, the HumPRO™ Addressing Mode Reference Guide.

DSN Addressing Mode

Device Serial Number Addressing mode is the simplest mode and supports point-to-point communications. Each module is programmed at the factory with a unique 4-byte serial number that cannot be changed. These bytes are found in the non-volatile read-only **MYDSN** registers (**MYDSN**[3-0]). DSN Addressing mode uses this serial number as an address. The transmitting unit's DSN is used as the source address and the intended receiver's DSN is written into the destination address registers (**DESTDSN**[3-0]). All modules within range hear the transmission, but only the module with the serial number that matches the destination address outputs the data on its UART. All others ignore the transmission.

User Addressing Mode

User Addressing Mode is a more flexible method than DSN Addressing Mode. It uses the customer ID bytes (**CUSTID**[1-0]) for unencrypted messages and two of the user destination bytes (**UDESTID**[1-0]) as a destination address. The customer ID bytes are programmed at the factory and cannot be changed. These are determined by the factory for specific customers to prevent their systems from operating with any other systems. Contact Linx for more details.

The module's local address is contained in two of the user source ID registers (**USRCID**[1-0]). In this mode, **USRCID** [1-0] contain the node address and **USRCID** [3-2] must be 0 in the receiver.

In normal operation each module has a user ID mask (**UMASK**[3-0]) that splits the 32 address bits into up to three fields to provide a network address and address fields for sub-networks, supporting both individual addressing and broadcast addressing within the user's network. A detailed explanation and examples are given in Reference Guide RG-00105. The 16 bits in the **UDESTID**[1-0] registers are transmitted. The upper 16 bits of **USRCID**[3-2] in the receiver must be 0.

If acknowledgements are enabled, only the module with a user source ID that exactly matches the transmitted user destination ID responds. The mask is not used for this determination.

Extended User Addressing Mode

Extended User Addressing mode is the same as User Addressing mode but uses 32-bit addresses. The two customer ID bytes are still used (**CUSTID**[1-0]) for unencrypted messages but four bytes are used for the user destination address (**UDESTID**[3-0]), user source ID (**USRCID**[3-0]) and user ID mask (**UMASK**[3-0]). This provides more addressing capabilities at the expense of more overhead in the packet.

Network Addressing

Network Addressing is selected by setting **COMPAT** to 0x03. It allows the receiver to receive all messages sent in User Address or Extended User Address mode with a destination address matching the **USRCID** group 1 bits (continuous high-order zero bits in **UMASK**). For example, with **USRCID** = 0x12345678 and **UMASK** = 0x000FFFFF, messages with destination address 0x123zzzzz, where z is any value, is received.

Automatic Addressing

The module supports an automatic addressing mode that reads the Source Address from a valid received packet and uses it to fill the Destination Address register. This makes sure that a response is sent to the device that transmitted the original message. This also allows the host microcontroller to read out the address of the sending unit. The automatic addressing is enabled for the different addressing modes with register [AUTOADDR](#).

Address Register Use

Figure 21 shows the address registers that are used with each addressing mode.

HumPRO™ Series Transceiver Address Registers						
COMPAT	0x00 (Relaxed Addressing)			0x02 (Normal Addressing)		
	0x04 (DSN)	0x06 (User)	0x07 (Ex User)	0x04 (DSN)	0x06 (User)	0x07 (Ex User)
ADDMODE	0x14 (DSN +ACK)	0x16 (User +ACK)	0x17 (ExUser +ACK)	0x14 (DSN +ACK)	0x16 (User +ACK)	0x17 (ExUser +ACK)
UDESTID[3-0]			X			X
UDESTID[1-0]		X			X	
USRC[3-0]			X		X	X
USRC[1-0]		X				
UMASK[3-0]			X		X	X
UMASK[1-0]		X				
DESTDSN[3-0]	X			X		

Figure 21: HumPRO™ Series Transceiver Address Register Use

Acknowledgements and Assured Delivery

When a module transmits with assured delivery enabled, the receiving module returns an acknowledgement packet. The transmitting module waits for this acknowledgement for a preset amount of time based on the data rate. If an acknowledgement is not received, it retransmits the packet. If the receiver receives more than one of the same packet, it discards the duplicate packet contents but sends an acknowledgment. This way, duplicate data is not output by the module.

If the received destination address matches the local address, the receiving module immediately sends an acknowledgement. This packet lets the sending module know that the message has been received. An acknowledgement packet is sent immediately following reception; CSMA delay is not applied to these packets since permission belongs to the interacting modules. When the sending module receives the acknowledgement packet, it marks the current block of data as completed. If this is the last message in the queue, the sending module takes the BE line high to indicate that all outgoing data has been sent.

Assured delivery should only be used when addressing a specific module in a point-to-point link. It should not be used when multiple receivers are enabled. When address masking is used, only the receiver with an exact match to the address in the transmitted packet responds. If none of the enabled receivers has an exact match, then there is no response and the transmitting module continues to re-transmit the data until the max number of retries is attempted. This causes the transmitting module to appear slow or unresponsive. It also impedes valid communications.

Listen Before Talk and Adaptive Frequency Agility

Europe's ETSI standards have very specific requirements for operating in the 868MHz band. The transmitter on-time is of particular note. This is specified in terms of Duty Cycle, which is the amount of time the transmitter can be active in a one-hour period. The requirements are contained in EN 300 220-1 and ERC Recommendation 70-03 summarizes the use of the 868MHz band by frequency and application.

The on-time for single channel devices depends on the specific transmit frequency and varies across the 868 to 870MHz band. It can be as low as 0.1% or 3.6 seconds per hour. It is normally up to the designer of the end product to ensure that the product cannot exceed this limit.

However, the rules also allow for higher transmit times if the radio uses intelligent or polite spectrum access techniques called Listen Before Talk (LBT) and Adaptive Frequency Agility (AFA). LBT is defined as a method where the radio listens on a channel to ensure it is clear before transmitting. AFA is defined as the capability to dynamically change channels within the available frequencies for proper operation. In other words, the radio listens to the channel to make sure it is clear. If it is occupied, it either waits for it to become clear or automatically goes to another channel.

A system that uses these spectrum access techniques is allowed more transmission time. This is advantageous for systems that need to transmit large data streams or have an unpredictable usage pattern. EN 300 220-1 has very specific requirements for LBT and transmitter on time as well as what declarations must be made by the manufacturer.

Listen Before Talk

EN 300 220-1 has the requirements, limits and methods of testing the LBT system. The main requirements are:

- An RSSI threshold above which the channel is considered busy. This is dependent on the channel bandwidth
- A minimum listening time of 5ms plus a random time between 0 and 5ms in steps of 0.5ms.
- A maximum dead time between the end of listening and start of talking.
- A minimum transmitter off time of more than 100ms.

A provision is made for acknowledgements to a transmission that allows them to transmit immediately, without needing to listen first.

Transmitter On-Time

EN 300 220-1 specifies three transmitter maximum on time limits:

1. 1s for a single transmission
2. 4s for multiple transmissions and acknowledgements for a communication dialogue or polling sequence of other units
3. 100s per hour for any 200 kHz of spectrum

These limits require the module to track the transmission times and impose delays when necessary to ensure compliance with the limits.

The module's packets have at most 192 payload bytes. This, combined with the largest header supported by the module at the 38.4kbps data rate equates to a maximum on time of 130ms. This is well under the limit.

The module imposes a 3.9s maximum on the transmission dialogue.

Since the module supports 100kHz channels, a 200kHz spectrum can bleed over into the higher and lower adjacent channels. This limits the transmission time on any given channel to 100s / 3 = 33.3s. The module uses 70 channels so it can transmit for 2,333s of every hour or about 64% assuming no delay for transmissions by other units.

It is preferable to spread the transmit time out evenly to avoid using all of the time at the start of the hour and then having 21 minutes delay at the end of the hour. To accomplish this, the module divides the time into blocks of 180s called bandspread intervals. The module can transmit on each channel for 1.66s of every 180s (33.3s of every 3600s ÷ 20). The module tracks the transmission time for each channel and limits it as well as monitoring the other required limits.

The LBT options are configured with the [ENC SMA](#) register. Setting the register to 0x00 disables LBT and the transmission is immediate. This can be used in applications with an inherent duty cycle <0.1%.

Setting the register to 0x01 enables LBT but without the transmitter on time duty cycle restriction. This can be used in applications with an inherent duty cycle of <10%.

Setting the register to 0x02 enables the full LBT with transmitter on time restriction. This complies with the ETSI regulations for LBT + AFA.

HumPRO™ Series Transceiver EN 300 220-1 Declarations

Item	Description
Receiver Category (4.1.1)	The module incorporates a short range radio device designed for use in applications in category 2 (medium reliable) or 3 (standard reliable)
General Performance Criteria (4.1.2)	The appropriate performance criterion for the HUM-868-PRO is "after demodulation, a message acceptance ratio of 80%". The test should be performed with bit 4 in the ADDMODE register (ack request) = 0. The external microcontroller normally supplies the indication for message acceptance. The MODE_IND output can be used as a packet received indication when the module is only receiving.
Duty Cycle (7.10.2)	The module is designed to provide up to 64% transmitter duty cycle when used with continuous demand for transmission when CSMAMODE = 2 (default). The actual duty cycle in operation, however, is primarily determined by average data rate and the size and timing of the packets containing the data. Thus, the end equipment has a critical part in determining the duty cycle and the manufacturer must declare the total duty cycle.
FHSS (7.4.1.2)	The module is intended to be certified as part of an AFA device, not an FHSS device.
Acknowledgement (7.10.2)	Acknowledgement can optionally be done at either the module level, application level, or both. If done at the module level through the use of ADDMODE bit 4, the acknowledgement causes the responding module to transmit for 4ms within less than 5ms after receiving the packet. If acknowledgement is provided by the application, the timing is mostly determined by the product response time and length of response message. In this case the applying manufacturer is responsible for declaring the timing.
Minimum TX-off Time (9.2.1.2)	The minimum TX-off time is 101ms. The actual time will be more if the external controller has no data to transmit.
LBT Fixed Minimum Listening Time (9.2.2.2 a)	The fixed minimum listening time is 5ms.
LBT Pseudo-random Listening Time (9.2.2.2 b)	The pseudo-random listening time, t_{PS} , varies from 0 to 5ms in 0.5ms steps: $t_{PS} = 0.5ms * \text{int}(((\text{Timer1} \& 0x1f) + 1)/3)$ The module serial number is added to a high-speed timer (incremented every 1.23µs) is used as a simple source of random value, due to the variation of time at which t_{PS} is calculated, relative to the timer period. The lower 5 bits of that sum is incremented by 1, giving a random value 1 to 32. That value is divided by 3, giving a value 0 to 10, with the value 0 occurring with $p=2/32$, other values occurring with $3/32$, resulting in an average value over several calculations of 5.33ms, slightly higher than the median value of 5.0.

Dead time (9.2.3)	The dead time between end of timeout of LBT listen time with a clear channel and starting the transmitter is 1.4 - 1.5ms.
TX On-Time for Single Transmission (9.2.5.2.1)	The TX On-time for a single transmission is variable, depending on the address mode used and number of payload bytes. The maximum single transmission time is 130ms (synchronizing preamble, 192 bytes payload, Extended User Address, encrypted).
TX On-time for a Transmission Dialogue (9.2.5.2.2)	The maximum duration for a TX dialogue imposed by the module is 3.9s.
Maximum TX On-Time within a Period of 1 Hour for Devices Using LBT + AFA (9.2.5.2.3)	The maximum module TX on-time for one hour is 64% with continuous transmission request and AFA limits enabled. The down time is <ol style="list-style-type: none"> 5ms minimum delay before transmitting on a new channel 100ms delay after 3.9s of continuous transmission. Dead time when all channels have exceeded their allotted time within their current 180s bandspread interval. The end-device maximum TX time is primarily determined by the application transmission requests.

Figure 22: HumPRO™ Series Transceiver EN 300 220-1 Declarations

Note: The integrator is solely responsible for ensuring that the final product complies with CE / ETSI requirements. This includes all testing and any application specific requirements.

Transmitting Packets

In default operation when transmitting, the host microcontroller writes bytes to the `CMD_DATA_IN` line while the $\overline{\text{CMD}}$ line is held high at the baud rate selected by the `UARTBAUD` register. The incoming bytes are buffered until one of the following conditions triggers the packet to be transmitted:

1. The number of bytes in the buffer exceeds the value in the Byte Count Trigger (`BCTRIG`) register.
2. The time since the last received byte exceeds the value in the Data Timeout (`DATATO`) register.
3. A `SENDP` command is written to the `CMD` register.
4. The $\overline{\text{CMD}}$ line is taken low with option `PKOPT: TXnCMD = 1`.
5. The number of buffered bytes exceeds what can be sent before the radio must hop channels.

The first four conditions can be controlled by the host microcontroller. In the last case, the module transmits what it can in the remaining time then sends the rest on the next channel. This can cause the data to be divided up into multiple packets and is not within the control of the host micro.

In cases where all data needs to be sent in the same packet or where the microcontroller needs greater control over the radio, the HumPRO™ offers explicit control of packet transmission with options in the `PKTOPT` register.

When the `TXPKT` option is enabled (`PKTOPT` register, bit 0 = 1), the data is held until a `SENDP` command is written to the `CMD` register. Alternatively, if option `TXnCMD` is enabled (`PKTOPT` register, bit 1 = 1), then lowering the $\overline{\text{CMD}}$ line triggers the packet transmission, reducing the number of UART transactions that are required. The `BCTRIG`, `DATATO` and hop-timing conditions are ignored when the `TXPKT` option is enabled.

Once triggered, the transmitted packet contains the bytes in the buffer as of the trigger event, even if more data bytes are received before the packet can be sent. Multiple outgoing packets can be buffered in this way.

If the full packet cannot be sent in the time remaining on the current channel, then it is held until the module hops to the next channel.

This option gives the host microcontroller very fine control over when packets are transmitted and what they contain.

Receiving Packets

In default operation when receiving valid packets, the module outputs all received bytes as soon as the packet is validated (CRC checks pass if unencrypted or key-based verification if encrypted) and if the addressing permits it at the baud rate selected by the `UARTBAUD` register. No command or control bytes are output and no action is required of an external microcontroller. The first byte from a packet directly follows the last byte of the previously received packet.

In cases where the host microcontroller needs more control over the data or where dynamic configuration changes could set up race conditions between incoming data and outgoing commands, the module offers explicit control over received packets.

When the `RXPKT` option is enabled (`PKTOPT` register, bit 2 = 1), received data is output on the `CMD_DATA_OUT` line one packet at a time after a `GETPH`, `GETPD`, or `GETPHD` command is written to the `CMD` register. Writing one of these commands begins the received packet transfer cycle.

Two lines are used as flow control and indicators during the transfer cycle. The $\overline{\text{CMD}}$ line is controlled by the host microcontroller. The module uses either the $\overline{\text{CTS}}$ line or the $\overline{\text{CRESP}}$ line as a status line, depending on the state of the `RXP_CTS` option in the `PKOPT` register.

When a valid packet is received, the `EX_RXWAIT` exception flag is set in the `EEXFLAG1` register. If the corresponding bit in the `EEXMASK1` register is set, then the `EX` line goes high. The host microcontroller can monitor the `EX` line or periodically check the `EEXFLAG` or `LSTATUS` registers to determine if data is ready to be read.

The transfer cycle is begun by writing a Get Packet Header (`GETPH`), Get Packet Data (`GETPD`), or Get Packet Header and Data (`GETPHD`) command to the `CMD` register. The module sends the command `ACK` byte and sets the selected status line high. Once the status line goes high, the host microcontroller sets the $\overline{\text{CMD}}$ line high and the module outputs the received data. The command sent determines whether the bytes sent are the header, data, or header followed by data.

When all packet bytes have been sent the control line goes low. When the host microcontroller detects that the line is low, it sets $\overline{\text{CMD}}$ low, completing the transfer cycle. The cycle is shown in Figure 23.

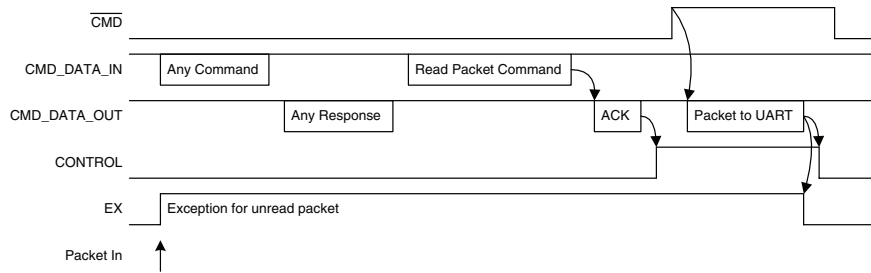

Figure 23: HumPRO™ Series Transceiver Received Packet Transfer Cycle

If a GETPH was sent and header data received, the following data can then be read by repeating the cycle with the GETPD command. If the next GETPx command is a GETPH or GETPHD, the data associated with the header read by GETPH is discarded and the header or header plus data of the following packet is returned.

If there is RF-received data waiting to be sent to the UART and the mask for EX_RXWAIT is set in the **EEXMASK** register, EX is raised if it is low.

If there is no packet waiting when a GETPx command is sent, the control line is still taken high and not reset until after $\overline{\text{CMD}}$ goes high, thereby performing a zero-byte transfer cycle.

The header and payload structures differ between encrypted packets and unencrypted packets. The header and data structures for explicit unencrypted packets are shown in Figure 24.

The Tag field identifies the start of the block and if it is the header information (0x01) or the packet data (0x02).

The Header Length field identifies the number of header bytes that follow.

The Frame Type field identifies what kind of packet was received. The values are shown in Figure 25.

The Hop ID field is the hop sequence number, 0 - 5.

The Sequence byte is incremented for each new packet, modulo 255. A received packet is discarded if the sequence byte matches the previously received packet to prevent delivering duplicate copies of an automatically retransmitted packet.

DSN Address Packet Header

Tag	Header Length	Frame Type	Hop ID	Sequence	Dest DSN	Source DSN	Data Length
0x01	1	1	1	1	4	4	1

User Address Packet Header

Tag	Header Length	Frame Type	Hop ID	Sequence	Cust ID	Dest Addr	Source Addr	Source DSN	Data Length
0x01	1	1	1	1	2	2 or 4	2 or 4	4	1

Packet Data

Tag	Data Length	Data
0x02	1	Data Length Bytes

Figure 24: HumPRO™ Series Transceiver Unencrypted Packet Header and Data Structure

HumPRO™ Series Transceiver Frame Types	
Frame Type	Packet Type
0x04	DSN Addressing Mode
0x06	User Addressing Mode
0x07	Extended User Addressing Mode
+0x10	Acknowledgements Enabled
+0x20	Encrypted Packet
+0x40	Long Preamble Packet

Figure 25: HumPRO™ Series Transceiver Frame Types

The Cust ID field is a number that can be assigned to a specific customer. Only modules with the same customer ID respond to unencrypted transmissions. By default, Cust ID is 0x7FFF for packets transmitted with COMPAT = 2 or 0xFFFF for packets transmitted with COMPAT = 0. This field is not used in DSN mode.

The Dest Addr field has the received destination address. This is 2 bytes long with User Addressing Mode and 4 bytes with DSN and Extended User Addressing Modes.

The Source Addr Field is the address of the transmitting module. This is 2 bytes long with User Addressing Mode and 4 bytes with DSN and Extended User Addressing Modes.

The Data Length byte indicates how many bytes of data are in the packet. This value is the same in the packet header and the associated data block.

The header and data structures for explicit encrypted packets are shown in Figure 26. The header and data blocks returned by the module are the decrypted message contents.

Encrypted DSN Address Packet Header

Tag	Header Length	Frame Type	Hop Key	Sequence	Dest DSN	Source DSN	EBlock Length	Payload Type
0x11	1	1	1	6	4	4	1	1

Encrypted User Address Packet Header

Tag	Header Length	Frame Type	Hop Key	Sequence	Dest Addr	Source Addr	Source DSN	EBlock Length	Payload Type
0x11	1	1	1	6	2 or 4	2 or 4	4	1	1

Encrypted Packet Data

Tag	Data Length	Data
0x12	1	Data Length Bytes

Figure 26: HumPRO™ Series Transceiver Encrypted Packet Header and Data Structure

The Tag, Header Length and Frame Type fields are the same as for unencrypted packets.

The Hop Key field uses the first three low-order bits to indicate the Hop Sequence number, which is the same as unencrypted packets. The upper two bits indicate which key is being used. Either the factory-set key that is used to securely transfer the network key or a network key that has been written or created by the JOIN process. This is shown in Figure 27.

HumPRO™ Series HopKey Byte Values	
HopKey Bit	Value
0 - 3	Hop Sequence Number, 1 to 5
4 - 5	= 0
6 - 7	Encryption key 0 = factory 1 = user network

Figure 27: HumPRO™ Series HopKey Byte Values

The Sequence bytes contain a counter that is incremented for each new transmitted message. The initial value is randomized when the module is reset. The extended sequence becomes part of an initialization vector which is used to vary the encrypted contents of identical packets. A received packet is discarded if the sequence byte matches the previously received packet to prevent delivering duplicate copies of an automatically retransmitted packet.

The Dest DSN, Source DSN, Dest Addr and Source Addr fields are the source and destination addresses, the same as in unencrypted packets.

The EBlock length field is the total number of bytes of data in the encrypted payload block. This length includes the Payload Type byte.

The Payload Type byte indicates what data is contained in the payload. 0x00 indicates that the payload is user data. 0x01 indicates that the payload is the 16-byte AES key followed by any user data. This is used for transferring the network encryption key during the JOIN process.

For the Encrypted Packet Data packet, the Data Length byte indicates the number of bytes of data payload that follow. This value is one less than the EBlock length in the header. The reason for this is that the Payload Type byte is included in the encrypted block, but is reported with the header since it is not user data.

Using the Buffer Empty (BE) Line

The BE line indicates the state of the module's UART buffer. It is high to indicate that the UART input buffer is empty, indicating that all data has been transmitted. When the module receives data on the CMD_DATA_IN line and the $\overline{\text{CMD}}$ line is high, the BE line is lowered until all data in the buffer has been processed by the protocol engine. If acknowledgement is not enabled, the BE line is raised as soon as the module transmits the outgoing packets. If acknowledgement is enabled, the buffer is not updated until either the data transmissions are acknowledged by the remote end or delivery fails after the maximum number of retries. When the BE line returns high, the EX line may be sampled, or the **EXCEPT** or **EEXFLAG** register polled to determine if an error occurred during transmission.

The state of the BE line can be read in the **LSTATUS** register, reducing the number of hardware connections that are needed.

Exception Engine

The HumPRO™ is equipped with an internal exception engine to notify the host microcontroller of an unexpected event. If errors occur during module operation, an exception is raised. There are two methods of driving the EX pin when an exception condition exists:

1. From the **EXMASK** and **EXCEPT** registers (legacy operation)
2. From the **EEXMASKx** and **EEXFLAGx** registers (standard operation)

If EXMASK is non-zero, the first method is used, otherwise the second method is used.

For legacy operation with the 250 and 25 Series, the EX line is set and reset by the Exception (**EXCEPT**) register processing. It is set when an exception occurs and the exception code ANDed with the current Exception Mask (**EXMASK**) register is non-zero. It is reset when the **EXCEPT** register is read through a command. No other operations affect the state of EX. Setting **EXMASK** non-zero does not change the state of EX.

If an exception code is already present in the register when an error occurs, the new exception code overwrites the old value. Exception codes are organized by type for ease of masking. Figure 28 lists the exception codes and their meanings.

HumPRO™ Series Transceiver Exception Codes		
Exception Code	Exception Name	Description
0x08	EX_BUFOVFL	Incoming UART buffer overflowed.
0x09	EX_RFOVFL	Outgoing UART buffer overflowed.
0x13	EX_WRITEREGFAILED	Attempted write to register failed.
0x20	EX_NORFACK	Acknowledgement packet not received after maximum number of retries.
0x40	EX_BADCRC	Bad CRC detected on incoming packet.
0x42	EX_BADHEADER	Bad CRC detected in packet header.
0x43	EX_BADSEQID	Sequence ID was incorrect in ACK packet.
0x44	EX_BADFRAMETYPE	Attempted transmit with Invalid setting in reg:NETMODE or invalid packet type in received packet header

Figure 28: HumPRO™ Series Transceiver Exception Codes

The EX line can be asserted to indicate to the host that an error has occurred. The **EXCEPT** register must be read to reset the line. Figure 29 lists some example exception masks.

HumPRO™ Series Transceiver Example Exception Masks	
Exception Mask	Exception Name
0x08	Allows only EX_BUFOVFL and EX_RFOVFL to trigger the EX line
0x10	Allows only EX_WRITEREGFAILED to trigger the EX line
0x20	Allows only EX_NORFACK to trigger the EX line
0x40	Allows only EX_BADCRC, EX_BADHEADER, EX_BADSEQID and EX_BADFRAMETYPE exceptions to trigger the EX line
0x60	Allows EX_BADCRC, EX_BADHEADER, EX_BADSEQID, EX_BADFRAMETYPE and EX_NORFACK exceptions to trigger the EX line
0xFF	Allows all exceptions to trigger the EX line

Figure 29: HumPRO™ Series Transceiver Example Exception Masks

The exception mask has no effect on the exceptions stored in the exception register. It only controls which exceptions affect the EX line.

The extended exception registers offer more functionality with more exceptions and a separate bit for each exception. These registers are the default and should be used with new applications. When an exception sets an exception code in the **EXCEPT** register, the corresponding flag in the **EEXFLAG** register is also set.

The EX line is set and reset by the Extended Exception Flags (**EEXFLAG**) and Extended Exception Mask (**EEXMASK**) register processing. It is set whenever the **EEXFLAG** value ANDed with the **EEXMASK** value is non-zero. EX can change on any write to either of these registers that affects the result of ANDing the registers. Clearing an **EEXFLAG** register bit or value can leave EX set if there is another masked condition bit set.

The state of the EX line can also be read in the **LSTATUS** register, reducing the number of hardware lines that are required.

Networking

The HumPRO™ Series modules can be used to create many types of wireless networks. The modules do not provide network routing since the internal memory size of the module would limit the overall network size. The HumPRO™ can work as the MAC/PHY layers of a network stack and the memory and processing speed of the external microcontroller can be sized according to the size of the network that is needed for the application.

This requires more software development, but avoids the cost of adding extra memory on the module for applications that don't need it. Linx can assist with network frameworks and concepts and can create custom designs on a contract basis. Contact Linx for more details.

Using the Command Response ($\overline{\text{CRESP}}$) Line

The $\overline{\text{CRESP}}$ line is high when sending data bytes and low when sending command response bytes. This indicates to an external host microcontroller that the data on the CMD_DATA_OUT line is a response to a command and not data received over-the-air. $\overline{\text{CRESP}}$ is held in the correct state at least one byte time after the last byte for the indicated source (command response or data, although it normally stays in the same state until a change is required).

If a data packet is received when the module is processing a command, it sends the command response, raises $\overline{\text{CRESP}}$, and then sends the received data bytes.

When reading or writing the module's register settings, it is possible for incoming RF data to intermix with the module's response to a configuration command. This can make it difficult to determine if commands were successfully processed as well as to capture the received RF data. Setting the CMDHOLD register to 0x01 causes the module to store incoming RF traffic (up to the RF buffer capacity) while the $\overline{\text{CMD}}$ line is low. When the $\overline{\text{CMD}}$ line is returned high, the module outputs the buffered data on the UART. This allows the external host microcontroller to have separate configuration times and data times instead of potentially having to handle both at once.

The $\overline{\text{CRESP}}$ line stays low for at least ten bit times after the stop bit of the last command response. Figure 30 shows the timing.

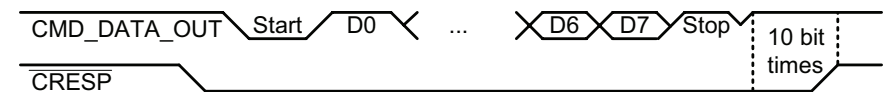

Figure 30: HumPRO™ Series Transceiver $\overline{\text{CRESP}}$ Line Timing

Using the $\overline{\text{CMD}}$ Line

The $\overline{\text{CMD}}$ line informs the module where incoming UART data should be routed. When the line is high, all incoming UART data is treated as payload data and is routed to the transmitter to be sent over the air. If the $\overline{\text{CMD}}$ line is low, the incoming UART data is treated as command bytes and is routed to the controller for processing.

Since the module's controller looks at UART data one byte at a time, the $\overline{\text{CMD}}$ line must be held low for the entire duration of the command plus time for ten bits as margin for processing. Leaving the line low for additional time (for example, until the ACK byte is received by the application) does not adversely affect the module. If RF packets are received while the $\overline{\text{CMD}}$ line is active, they are still processed and output on the module's UART (assuming $\text{CMDHOLD}=0$ and $\text{PKOPT:RXPKT}=0$). Figure 31 shows this timing.

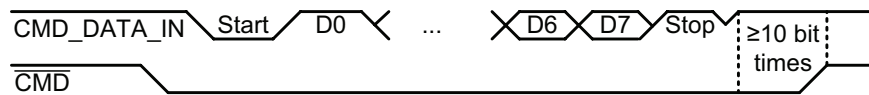

Figure 31: HumPRO™ Series Transceiver $\overline{\text{CMD}}$ Line Timing

Commands can be entered sequentially without having to raise the $\overline{\text{CMD}}$ line after each one. The $\overline{\text{CMD}}$ line just needs to be raised to be able to enter data for transmission.

If the CMDHOLD register is 0x01 then any received data is held until the $\overline{\text{CMD}}$ line is raised. This prevents received data from being intermingled with command responses.

External Amplifier Control

The HumPRO™ Series transceiver has two output lines that are designed to control external amplifiers. The PA_EN line goes high when the module activates the transmitter. This can be used to activate an external power amplifier to boost the signal strength of the transmitter. The LNA_EN line goes high when the module activates the receiver. This can be used to activate an external low noise amplifier to boost the receiver sensitivity. These external amplifiers can significantly increase the range of the system at the expense of higher current consumption and system cost.

The states of the PA_EN and LNA_EN lines can be read in the LSTATUS register. This offers a quick way to determine the current state of the radio.

AES Encryption

HumPRO™ Series modules with firmware version 2.0 and above offer AES encryption. Encryption algorithms are complex mathematical calculations that use a large number called a key to scramble data before transmission. This is done so that unauthorized persons who may intercept the signal cannot access the data. To decrypt the data, the receiver must use the same key that was used to encrypt it. It performs the same calculations as the transmitter and if the key is the same, the data is recovered.

The HumPRO™ Series module has the option to use AES encryption, arguably the most common encryption algorithm on the market. This is implemented in a secure mode of operation to ensure the secrecy of the transmitted data. It uses a 128-bit key to encrypt the transmitted data. The source and destination addresses are sent in the clear.

Encryption is disabled by default. There are two ways to enable encryption and set the key: sending serial commands and using the JOIN process.

Writing an encryption key to the module with the CDI

The module has no network key when shipped from the factory. An encryption key can be written to the module using the CDI. The CMD register is used to write or clear a key. The key cannot be read.

The same key must be written to all modules that are to be used together. If they do not have the same key then they will not communicate in encrypted mode.

The JOIN Process

The JOIN process is a method of generating an encryption key and distributing the key and addresses to associated modules through a series of button presses. This makes it very simple to establish an encrypted network in the field or add new nodes to an existing network without any additional equipment. It is also possible to trigger the JOIN process through commands on the Command Data Interface.

The JOIN process configures a star network with the central unit as system administrator. Other units are added to the network one at a time.

The hardware required is a pushbutton that is connected to the PB line. This takes the line to VCC when it is pressed and ground when it is released. An LED connected to the MODE_IND line provides visual indication of the module's state.

A module is set as an administrator by pressing and holding the button for 30 seconds to start the Generate Key function. While the button is held, the MODE_IND line is on. After 30s, the MODE_IND line repeats a double blink, indicating that the function has begun. When the button is released the key and address generation are complete and the module is an administrator.

When Generate Key is performed, the unit is set as the network administrator. It generates a random 128-bit AES encryption key based on ambient RF noise and scrambled by an encryption operation. If UMASK is the default value (0xFFFFFFFF), it is set to 0x000000FF, supporting up to 255 nodes, and ADDMODE is set to Extended User Address with encryption (0x27) (or without encryption (0x07) if flag PGKEY in the SECOPT register is 0). UMASK and ADDMODE are not changed if UMASK is not 0xFFFFFFFF. A random 32-bit address is generated. By default, the lower 8 bits are 0, forming the network base address. Other nodes are assigned sequential addresses, starting with network base address +1. UDESTID is set to the bitwise OR of USRCID and UMASK, which is the network broadcast address.

A module becomes a node by joining with an administrator. This is done by pressing and releasing the PB button on both units. The modules automatically search for each other using a special protocol. When they find each other, the administrator sends the node the encryption key, UMASK and its network address. The UDESTID is set to the address of the administrator. The values are encrypted using a special factory-defined key. Once the JOIN process is complete, the MODE_IND blinks on both units and they now operate together. This is shown in Figure 32 A.

If UMASK is pre-set when Generate Key is initiated, then the JOIN process uses that mask and sets the address accordingly. This can allow more nodes in the network. This is shown in Figure 32 B. Likewise, the network key can be written to the module with the CDI interface and the JOIN process used to create an address and associate new modules. Or the administrator can be completely configured through the CDI and the JOIN process used to associate nodes in the field. This gives the system designer many options for configuration.

The SECOPT register is used to configure options related to the JOIN process. This allows the OEM to set desired values at the factory and allow final network configuration in the field. This includes disabling the ability to change the address, change the key and share the key. The built-in security prohibits changing a node to an administrator without changing the key.

A) Key Generation and Network Join from Factory Default

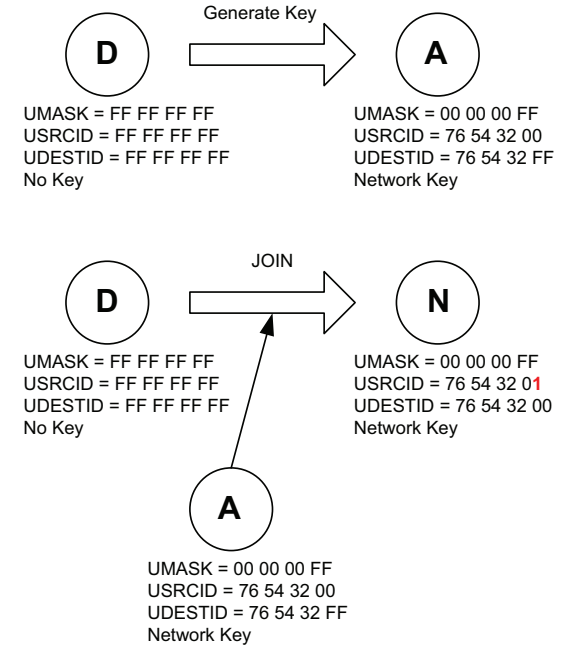

B) Key Generation and Network Join from Preset Mask

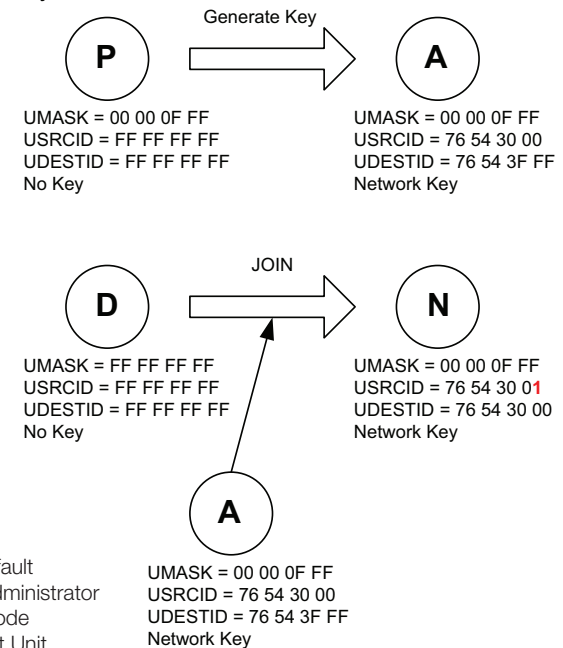

D = Factory Default
 A = Network Administrator
 N = Network Node
 P = OEM Preset Unit

UMASK = 00 00 0F FF
 USRCID = 76 54 30 00
 UDESTID = 76 54 3F FF
 Network Key

Figure 32: HumPRO™ Series JOIN Process

Restore Factory Defaults

The transceiver is reset to factory default by taking the PB line high briefly 4 times, then holding PB high for more than 3 seconds. Each brief interval must be high 0.1 to 2 seconds and low 0.1 to 2 seconds. (1 second nominal high / low cycle). The sequence helps prevent accidental resets. Once the sequence is recognized, the MODE_IND line blinks in groups of three until the PB line goes low. After PB goes low, the non-volatile configurations are set to the factory default values and the module is restarted. The default UART data rate is 9,600bps.

If the timing on PB does not match the specified limits, the sequence is ignored. Another attempt can be made after lowering PB for at least 3 seconds.

Using the Low Power Features

The module supports several low-power features to save current in battery-powered applications. This allows the module to be asleep most of the time, but be able to quickly wake up, send data and go back to sleep.

Taking the Power Down ($\overline{\text{POWER_DOWN}}$) line low places the module into the lowest power state. In this mode, the internal voltage regulator and all oscillators are turned off. All circuits powered from the voltage regulator are also off. The module is not functional while in this mode and current consumption drops to below 6 μ A. Taking the line high wakes the module.

When the $\overline{\text{POWER_DOWN}}$ line is high, the **IDLE** register determines sleep operation.

If **IDLE** is set to 1 during normal operation, the module sends an ACK byte, waits for completion of an active transmission, then goes into sleep mode. Unsent data in the incoming UART data buffer does not inhibit sleep. During sleep mode, the output lines are in the states in Figure 36.

A rising transition on the $\overline{\text{POWER_DOWN}}$ or CMD_DATA_IN lines wakes the module. If a negative-going pulse is needed to generate a rising edge, the pulse width should be greater than 1 μ s.

Other lines also wake the module but it immediately goes back to sleep. Floating inputs should be avoided since they may cause unintended transitions and cause the module to draw additional current.

HumPRO™ Series Transceiver Output Line Sleep States	
Output Line	Sleep State
EX	Unchanged
$\overline{\text{CRESP}}$	Low
LNA_EN	Low
PA_EN	Low
TXD	High
$\overline{\text{CTS}}$	High
MODE_IND	Low
BE	Unchanged

Figure 36: HumPRO™ Series Output Line Sleep States

If the volatile registers have been corrupted during sleep, a software reset is performed. This restarts the module as if power were cycled. This can be caused by power surges or brownout among other things.

After the module wakes up, it sets the **IDLE** register to 0 (active). If the **WAKEACK** register is set to 1, then the module outputs the 0x06 byte on the CMD_DATA_OUT line. The $\overline{\text{CRESP}}$ line is taken high and the module then begins normal operation.

Pulsing $\overline{\text{RESET}}$ low causes the module to restart rather than continue from sleep.

The Command Data Interface

The HumPRO™ Series transceiver has a serial Command Data Interface (CDI) that is used to configure and control the transceiver through software commands. This interface consists of a standard UART with a serial command set. The CMD_DATA_IN and CMD_DATA_OUT lines are the interface to the module's UART. The UART is configured for 1 start bit, 1 stop bit, 8 data bits, no parity and a serial data rate set by register **UARTBAUD** (default 9,600bps). The $\overline{\text{CMD}}$ line tells the module if the data on the UART is for configuration commands (low) or data transmission (high).

The module has a 256 byte buffer for incoming data. The module starts transmitting when the buffer reaches a specified limit or when the time since the last received byte on the UART reaches a specified value. This allows the designer to optimize the module for fixed length and variable length data.

If the buffer gets nearly full (about 224 bytes), the module pulls the $\overline{\text{CTS}}$ line high, indicating that the host should not send any more data. Data sent by the host while the buffer is full is lost, so the $\overline{\text{CTS}}$ line provides a warning and should be monitored. When there is outgoing data waiting to be transmitted or acknowledged the BE line is low, otherwise BE is high.

Configuration settings are stored in two types of memory inside the module. Volatile memory is quick to access, but it is lost when power is removed from the module. Non-volatile memory has a limited number of write cycles, but is retained when power is removed. When a configuration parameter has both a non-volatile and volatile register, the volatile register controls the operation unless otherwise stated. The non-volatile register holds the default value that is loaded into the volatile register on power-up.

Configuration settings are read from non-volatile memory on power up and saved in volatile memory. The volatile and non-volatile registers have different address locations, but the same read and write commands. The two locations can be changed independently.

The general serial command format for the module is:

[FF] [Length] [Command]

The Length byte is the number of bytes in the Command field. The

Command field contains the register address that is to be accessed and, in the case of a write command, the value to be written. Neither Length nor Command can contain a 0xFF byte.

Byte values of 128 (0x80) or greater can be sent as a two-byte escape sequence of the format:

0xFE, [value - 0x80]

For example, the value 0x83 becomes 0xFE, 0x03. The Length count includes the added escape bytes.

A response is returned for all valid commands. The first response byte is CMD_ACK (0x06) or CMD_NACK (0x15). Additional bytes may follow, as determined by the specific command.

Reading from Registers

A register read command is constructed by placing an escape character (0xFE) before the register number. The module responds by sending an ACK (0x06) followed by the register number and register value. The register value is sent unmodified, so if the register value is 0x83, 0x83 is returned. If the register number is invalid, the module responds with a NACK (0x15). The command and response are shown in Figure 37.

HumPRO™ Series Read From Configuration Register				
Command				
Header	Size	Escape	Address	
0xFF	0x02	0xFE	REG	
Response				
ACK	Address	Value		
0x06	REG	V		
Command for an Address greater than 128 (0x80)				
Header	Size	Escape	Addr1	Addr2
0xFF	0x03	0xFE	0xFE	REG-80
Response				
ACK	Address	Value		
0x06	REG	V		

Figure 37: HumPRO™ Series Read from Configuration Register Command and Response

Writing to Registers

To allow any byte value to be written, values of 128 (0x80) or greater can be encoded into a two-byte escape sequence of the format 0xFE, [value - 0x80]. This includes register addresses as well as values to be written to the registers. The result is that there are four possible packet structures because of the possible escape sequences. These are shown in Figure 38.

HumPRO™ Series Write to Configuration Register Command					
Register and Value less than 128 (0x80)					
Header	Size	Address	Value		
0xFF	0x02	REG	V		
Register less than 128 (0x80) and a Value greater than or equal to 128 (0x80)					
Header	Size	Address	Escape	Value	
0xFF	0x03	REG	0xFE	V-0x80	
Register greater than or equal to 128 (0x80) and a Value less than 128 (0x80)					
Header	Size	Escape	Address	Value	
0xFF	0x03	0xFE	REG-0x80	V	
Register and Value greater than or equal to 128 (0x80)					
Header	Size	Escape	Address	Escape	Value
0xFF	0x04	0xFE	REG-0x80	0xFE	V-0x80

Figure 38: HumPRO™ Series Write to Configuration Register Command

Generally, there are three steps to creating the command.

1. Determine the register address and the value to be written.
2. Encode the address and value as either the number (N) or the encoded number (0xFE, N-0x80) as appropriate.
3. Add the header (0xFF) and the size.

The module responds with an ACK (0x06). If the ACK is not received, the command should be resent. The module responds with a NACK (0x15) if a write is attempted to a read-only or invalid register.

As an example, to write 01 to register 0x83, send

FF 03 FE 03 01

Note: The non-volatile memory has a life expectancy of at least 18,000 write operations.

Command Length Optimization

Some commands may be shortened by applying the following rules:

1. Escape sequences are not required for byte values 0x00 to 0xEF (besides 0xFE and 0xFF, bytes 0xF0 – 0xFD are reserved for future use).
2. An escape byte inverts bit 7 of the following data byte.
3. The 0xFE as the first byte of the Read Register Command field is an escape byte.
4. Two consecutive escape bytes cancel unless the following data byte is 0xf0-0xff.

Examples:

- FF 02 FE 02 (read nv:TXPWR) is equivalent to FF 01 82.
- FF 03 FE FE 53 (read v:PKOPT) is equivalent to FF 01 53.
- FF 03 1A FE 7F (write FF to nv:UMASK0) cannot be shortened.
- FF 03 1A FE 40 (write C0 to nv:UMASK0) is equivalent to FF 02 1A C0.

These rules are implemented in the sample code file EncodeProCmd.c, which can be downloaded from the Linx website.

Example Code for Encoding Read/Write Commands

This software example is provided as a courtesy in “as is” condition. Linx Technologies makes no guarantee, representation, or warranty, whether express, implied, or statutory, regarding the suitability of the software for use in a specific application. The company shall not, in any circumstances, be liable for special, incidental, or consequential damages, for any reason whatsoever.

File EncodeProCmd.c

```
/* Sample C code for encoding Hum-xxx-PRO commands
**
** Copyright 2015 Linx Technologies
** 155 Ort Lane
** Merlin, OR, US 97532
** www.linxtechnologies.com
**
** License:
** Permission is granted to use and modify this code, without royalty, for
** any purpose, provided the copyright statement and license are included.
*/

#include "EncodeProCmd.h"

/* Function: HumProCommand
** Description: This function encodes a command byte sequence.
** If len = 1, a read command is generated.
** If len > 1, a write command is generated.
** rcmd[0] = register number
** rcmd[1..(n-1)] = bytes to write
*/
unsigned char HumProCommand( /* number of encoded bytes, n+2 to 2*n+2 */
    unsigned char *ecmd, /* out: encoded command, length >= 2*n + 2 */
    const unsigned char *rcmd, /* in: sequence of bytes to encode */
    unsigned char n /* number of bytes in rcmd, 1..32 */
){
    unsigned char dx; /* destination index */
    unsigned char sx; /* source index */
    unsigned char v; /* value to be encoded */
    dx = 2;
    sx = 0;
    while (n--) {
        v = rcmd[sx++];
        if (v >= 0xf0) {
            ecmd[dx++] = 0xfe;
            v &= 0x7f;
        }
        ecmd[dx++] = v;
    }
    ecmd[0] = 0xff;
    ecmd[1] = dx - 2;
}
```

```
    return dx;
}

/* Function: HumProRead
** Description: This function encodes a read command to the specified
** register address.
*/
unsigned char HumProRead( /* number of encoded bytes, 3 to 4 */
    unsigned char *cmd, /* out: encoded read command, length >= 4 */
    unsigned char reg /* register number to read, 0..0xff */
){
    unsigned char ra; /* read register byte */

    ra = reg ^ 0x80;
    return HumProCommand(cmd, &ra, 1);
}

/* Function: HumProWrite
** Description: This function encodes a command to write a single byte to
** a specified register address.
*/
unsigned char HumProWrite( /* number of encoded bytes, 4 to 6 */
    unsigned char *cmd, /* out: encoded read command, length >= 6 */
    unsigned char reg, /* register number to write, 0..0xff */
    unsigned char val /* value byte, 0..0xff */
){
    unsigned char cs[2];
    cs[0] = reg;
    cs[1] = val;
    return HumProCommand(cmd, &cs, 2);
}
```

The Command Data Interface Command Set

The following sections describe the registers.

HumPRO™ Series Configuration Registers					
Name	NV Addr	Vol Addr	R/W	Default Value	Description
CRCERRS		0x40	R/W	0x00	CRC Error Count
HOPTABLE	0x00	0x4B	R/W	0x00	Channel Hop Table
TXPWR	0x02	0x4D	R/W	0x03	Transmit Power
UARTBAUD	0x03	0x4E	R/W	0x01	UART data rate
ADDMODE	0x04	0x4F	R/W	0x04	Addressing mode
DATATO	0x05	0x50	R/W	0x10	Data timeout
MAXTXRETRY	0x07	0x52	R/W	0x1A	Maximum Transmit Retries
ENCRC	0x08	0x53	R/W	0x01	Enable CRC checking
BCTRIG	0x09	0x54	R/W	0x40	Byte Count trigger
SHOWVER	0x0A		R/W	0x01	Show version on startup
ENCSMA	0x0B	0x56	R/W	0x02	Enable CSMA
IDLE	0x0D	0x58	R/W	0x00	Idle Mode
WAKEACK	0x0E	0x59	R/W	0x01	UART Acknowledge on Wake
UDESTID3	0x0F	0x5A	R/W	0xFF	Destination Address for User Packet Type, extended
UDESTID2	0x10	0x5B	R/W	0xFF	Destination Address for User Packet Type, extended
UDESTID1	0x11	0x5C	R/W	0xFF	Destination Address for User Packet Type
UDESTID0	0x12	0x5D	R/W	0xFF	Destination Address for User Packet Type
USRCID3	0x13	0x5E	R/W	0xFF	Source Address for User Packet Type, extended
USRCID2	0x14	0x5F	R/W	0xFF	Source Address for User Packet Type, extended
USRCID1	0x15	0x60	R/W	0xFF	Source Address for User Packet Type
USRCID0	0x16	0x61	R/W	0xFF	Source Address for User Packet Type
UMASK3	0x17	0x62	R/W	0xFF	Address Mask for User Packet Type, extended
UMASK2	0x18	0x63	R/W	0xFF	Address Mask for User Packet Type, extended
UMASK1	0x19	0x64	R/W	0xFF	Address Mask for User Packet Type
UMASK0	0x1A	0x65	R/W	0xFF	Address Mask for User Packet Type
DESTDSN3	0x1D	0x68	R/W	0xFF	Destination Device Serial Number
DESTDSN2	0x1E	0x69	R/W	0xFF	Destination Device Serial Number
DESTDSN1	0x1F	0x6A	R/W	0xFF	Destination Device Serial Number

DESTDSN0	0x20	0x6B	R/W	0xFF	Destination Device Serial Number
EXMASK	0x21	0x6C	R/W	0x00	Exception Mask to activate EX
CMDHOLD	0x23	0x6E	R/W	0x00	Hold RF data when nCMD pin is low
COMPAT	0x25	0x70	R/W	0x02	Compatibility
AUTOADDR	0x26	0x71	R/W	0x00	Automatic Reply Address
MYDSN3	0x34		R		Factory programmed Serial Number
MYDSN2	0x35		R		Factory programmed Serial Number
MYDSN1	0x36		R		Factory programmed Serial Number
MYDSN0	0x37		R		Factory programmed Serial Number
CUSTID1	0x39		R	0xFF	Factory programmed customer ID
CUSTID0	0x3A		R	0xFF	Factory programmed customer ID
CSRSSI	0x3F		R/W	0xA4	Carrier Sense minimum RSSI
RELEASE	0x78		R		Release number
EXCEPT		0x79	R	0x00	Exception code
PRSSI		0x7B	R	0x00	Packet RSSI
ARSSI		0x7C	R	0x00	Ambient RSSI
FWVER3	0xC0		R		Firmware version, major
FWVER2	0xC1		R		Firmware version, minor
FWVER1	0xC2		R		Firmware version, increment
FWVER0	0xC3		R		Firmware version, suffix
NVCYCLE1	0xC4		R		NV Refresh Cycles, MS
NVCYCLE0	0xC5		R		NV Refresh Cycles, LS
LSTATUS		0xC6	R		Output line status
CMD		0xC7	W		Command register
SECSTAT		0xC9	R		Security Status
JOINST		0xCA	R	0x00	Join Status
EEXFLAG2		0xCD	R/W	0x00	Extended exception flags
EEXFLAG1		0xCE	R/W	0x00	Extended exception flags
EEXFLAG0		0xCF	R/W	0x00	Extended exception flags
EEXMASK2	0x80	0xD0	R/W	0x00	Extended exception mask
EEXMASK1	0x81	0xD1	R/W	0x00	Extended exception mask
EEXMASK0	0x82	0xD2	R/W	0x00	Extended exception mask
PKTOPT	0x83	0xD3	R/W	0x00	Packet options
SECOPT	0x84	0xD4	R/W	0xFF	Security Options
LASTNETAD[3]	0x8C		R/W	0x00	Last Network Address Assigned
LASTNETAD[2]	0x8D		R/W	0x00	Last Network Address Assigned
LASTNETAD[1]	0x8E		R/W	0x00	Last Network Address Assigned
LASTNETAD[0]	0x8F		R/W	0x00	Last Network Address Assigned

Figure 39: HumPRO™ Series Configuration Registers

CRCERRS - CRC Error Count

Volatile Address = 0x40

The value in the CRCERRS register is incremented each time a packet with a valid header is received that fails the CRC check on the payload. This check applies only to unencrypted packets. Overflows are ignored. Writing 0x00 to this register initializes the count. Figure 40 shows the command and response.

HumPRO™ Series CRC Error Count							
Read Command				Read Response			
Header	Size	Escape	Address	ACK	Address	Value	
0xFF	0x02	0xFE	0x40	0x06	0x40	V	
Write Command							
Header	Size	Address	Value				
0xFF	0x02	0x40	V				

Figure 40: HumPRO™ Series CRC Error Count Command and Response

HOPTABLE - Channel Hop Table

Volatile Address = 0x4B; Non-Volatile Address = 0x00

The module supports 6 different hop sequences with minimal correlation. The sequence is set by the value in the HOPTABLE register. Changing the hop sequence changes the band utilization, much the same way that a channel does for a non-hopping transmitter. The hop table selection must match between the transmitter and receiver. Valid values are 0-5. Figure 41 shows the command and response.

HumPRO™ Series Channel Hop Table							
Read Command				Read Response			
Header	Size	Escape	Address	ACK	Address	Value	
0xFF	0x02	0xFE	0x4B 0x00	0x06	0x4B 0x00	V	
Write Command							
Header	Size	Address	Value				
0xFF	0x02	0x4B 0x00	V				

Figure 41: HumPRO™ Series Channel Hop Table Command and Response

Figure 42 shows the RF channels used by the HumPRO™ Series. Figure 43 shows the hop sequences referenced by channel number. The default hop sequence is 0.

HumPRO™ Series RF Channels			
Channel Number	Frequency (MHz)	Channel Number	Frequency (MHz)
0	863.05	35	866.55
1	863.15	36	866.65
2	863.25	37	866.75
3	863.35	38	866.85
4	863.45	39	866.95
5	863.55	40	867.05
6	863.65	41	867.15
7	863.75	42	867.25
8	863.85	43	867.35
9	863.95	44	867.45
10	864.05	45	867.55
11	864.15	46	867.65
12	864.25	47	867.75
13	864.35	48	867.85
14	864.45	49	867.95
15	864.55	50	868.05
16	864.65	51	868.15
17	864.75	52	868.25
18	864.85	53	868.35
19	864.95	54	868.45
20	865.05	55	868.55
21	865.15	56	868.65
22	865.25	57	868.75
23	865.35	58	868.85
24	865.45	59	868.95
25	865.55	60	869.05
26	865.65	61	869.15
27	865.75	62	869.25
28	865.85	63	869.35
29	865.95	64	869.45
30	866.05	65	869.55
31	866.15	66	869.65
32	866.25	67	869.75
33	866.35	68	869.85
34	866.45	69	869.95

Figure 42: HumPRO™ Series RF Channels

HumPRO™ Series Hop Sequences by Channel Number						
Channel Index	0	1	2	3	4	5
1	52	50	40	67	13	42
2	42	67	25	38	49	20
3	45	24	54	14	60	4
4	50	49	1	4	28	9
5	18	42	43	49	35	26
6	11	61	60	20	42	54
7	67	28	66	57	67	51
8	28	51	16	65	32	40
9	62	10	29	34	5	49
10	48	21	58	39	16	37
11	51	16	30	12	69	36
12	29	29	64	40	7	63
13	33	54	68	60	9	25
14	31	59	56	53	52	7
15	24	3	36	31	66	55
16	22	17	47	32	24	31
17	15	64	38	47	17	62
18	5	40	19	30	4	46
19	8	60	51	0	39	39
20	68	18	33	17	0	2
21	32	37	46	9	3	43
22	12	63	55	43	26	41
23	43	48	61	33	30	10
24	34	46	12	58	29	35
25	69	57	17	59	51	60
26	13	47	21	46	65	38
27	57	5	9	54	68	30
28	0	34	4	7	36	68
29	10	22	2	26	58	21
30	2	9	14	22	22	61
31	39	4	52	1	12	5
32	59	0	0	61	34	1
33	46	45	3	10	53	59
34	49	23	67	35	6	22
35	65	53	65	21	2	19
36	7	30	24	62	33	8
37	66	7	28	36	47	53
38	21	2	42	16	45	67
39	3	31	41	66	23	14
40	4	15	53	69	61	12
41	23	66	69	6	21	16
42	25	11	35	3	20	11
43	26	36	45	56	41	0
44	19	27	7	37	64	44
45	6	14	34	15	62	69
46	54	44	15	41	10	17
47	53	55	49	51	31	48
48	9	19	26	50	48	57
49	16	39	62	44	56	24

HumPRO™ Series Hop Sequences by Channel Number						
Channel Index	0	1	2	3	4	5
50	14	35	57	28	25	66
51	58	32	6	27	38	18
52	38	69	5	68	54	32
53	63	41	22	13	15	15
54	27	26	27	25	43	58
55	41	8	10	63	57	34
56	37	56	20	64	11	28
57	64	65	8	48	46	23
58	40	6	11	52	50	27
59	55	68	39	19	37	29
60	35	38	32	2	44	13
61	30	58	63	5	55	47
62	60	25	31	29	18	56
63	47	33	59	42	63	6
64	44	62	13	45	59	45
65	1	52	18	8	8	65
66	61	43	48	11	19	3
67	36	20	44	24	27	64
68	20	1	23	23	14	50
69	56	12	37	55	1	52
70	17	13	50	18	40	33

Figure 43: HumPRO™ Series Hop Sequences

TXPWR - Transmitter Output Power

Volatile Address = 0x4D; Non-Volatile Address = 0x02

The value in the TXPWR register sets the module's output power. Figure 44 shows the command and response and Figure 45 available power settings and typical power outputs for the module. The default setting is 0x03.

HumPRO™ Series Transmitter Output Power Mode							
Read Command				Read Response			
Header	Size	Escape	Address	ACK	Address	Value	
0xFF	0x02	0xFE	0x4D 0x02	0x06	0x4D 0x02	PWR	
Write Command							
Header	Size	Address	Value				
0xFF	0x02	0x4D 0x02	PWR				

Figure 44: HumPRO™ Series Transmitter Output Power Mode Command and Response

HumPRO™ Series Transmitter Output Power Mode Register Settings	
PWR	Typical Output Power (dBm)
0x00	-5
0x01	0
0x02	+5
0x03	+9

Figure 45: HumPRO™ Series Transmitter Output Power Mode Settings

UARTBAUD - UART Baud Rate

Volatile Address = 0x4E; Non-Volatile Address = 0x03

The value in UARTBAUD sets the data rate of the UART interface. Changing the non-volatile register changes the data rate on the following power-up or reset. Changing the volatile register changes the data rate immediately following the command acknowledgement. Figure 46 shows the command and response and Figure 47 shows the valid settings.

HumPRO™ Series UART Baud Rate							
Read Command				Read Response			
Header	Size	Escape	Address	ACK	Address	Value	
0xFF	0x02	0xFE	0x4E 0x03	0x06	0x4E 0x03	V	
Write Command							
Header	Size	Address	Value				
0xFF	0x02	0x4E 0x03	V				

Figure 46: HumPRO™ Series UART Baud Rate Command and Response

HumPRO™ Series UART Baud Rate Register Settings		
V	Baud Rate (bps)	RF Data Rate (bps)
0x01	9,600	38,384
0x02	19,200	38,384
0x03	38,400	38,384
0x04	57,600	38,384
0x05	115,200	38,384
0x06	10,400*	38,384
0x07	31,250*	38,384

* These data rates are not supported by PC serial ports. Selection of these rates may cause the module to fail to respond to a PC, requiring a reset to factory defaults.

Figure 47: HumPRO™ Series UART Baud Rate Settings

If the module's UART baud rate is different than the host processor UART baud rate then the module will not communicate correctly. If mismatched, every rate can be tested until the correct one is found or the module can be reset to factory defaults. The default baud rate is 9,600bps (0x01).

ADDMODE - Addressing Mode

Volatile Address = 0x4F; Non-Volatile Address = 0x04

The module supports three addressing modes: DSN, User, and Extended User, which are configured using bits 0 - 2.

If bit 3 is set, the module sends an extended preamble. This allows modules that have just awakened or have not yet synchronized to find and temporarily synchronize with the transmitting module. This can be useful in systems that require the endpoints to spend most of their time sleeping. Endpoints can awaken, receive a message from the transmitter, and go back to sleep. This message could contain scheduling information as to when to wake again for a full bi-directional communications session.

If bit 4 is set, then the receiver is instructed to transmit an acknowledgement packet for assured delivery signifying to the transmitter that the message was received.

If bit 5 is set then the module transmits data in encrypted mode.

Figure 48 shows the command and response and Figure 49 shows the valid settings.

HumPRO™ Series Addressing Mode			
Read Command			
Header	Size	Escape	Address
0xFF	0x02	0xFE	0x4F 0x04
Write Command			
Header	Size	Address	Value
0xFF	0x02	0x4F 0x04	V
Read Response			
ACK	Address	Value	
0x06	0x4F 0x04	V	

Figure 48: HumPRO™ Series Addressing Mode Command and Response

HumPRO™ Series Addressing Mode Register Settings	
Addressing Mode	Meaning
0x04	DSN Addressing Mode
0x06	User Addressing Mode
0x07	Extended User Addressing Mode
+0x00	Send normal preamble
+0x08	Send long preamble
+0x10	Request acknowledgments
+0x20	Encrypt packets

All other addressing modes are reserved and may cause undesired operation.

Figure 49: HumPRO™ Series Addressing Mode Register Settings

DATATO - Transmit Wait Timeout

Volatile Address = 0x50; Non-Volatile Address = 0x05

When a byte is received from the UART, the module starts a timer that counts down every millisecond. The timer is restarted when each byte is received. The value for the DATATO register is the number of milliseconds to wait before transmitting the data in the UART receive buffer. The default setting for this register is 0x10 (~16ms delay).

If the timer reaches zero before the next byte is received from the UART, the module begins transmitting the data in the buffer. This timeout value should be greater than one byte time at the current UART baud rate with a minimum of 0x02. It should not be set any value less than one byte time as unpredictable results could occur.

If the timeout value is set to 0x00, the transmit wait timeout is deactivated. In this case, the transceiver waits until a number of bytes equal to the UART Byte Count Trigger (BCTRIG) have been received by the UART. All of the bytes are sent once the trigger has been reached. Figure 50 shows examples of the commands. Figure 51 shows the minimum timeout values based on baud rate.

HumPRO™ Series Transmit Wait Timeout						
Read Command				Read Response		
Header	Size	Escape	Address	ACK	Address	Value
0xFF	0x02	0xFE	0x50 0x05	0x06	0x50 0x05	V
Write Command						
Header	Size	Address	Value			
0xFF	0x02	0x50 0x05	V			

Figure 50: HumPRO™ Series Transmit Wait Timeout Command and Response

HumPRO™ Series Minimum DATATO Values	
Baud Rate	Minimum DATATO
9,600	3ms
19,200	2ms
38,400	2ms
57,600	2ms
115,200	2ms

Figure 51: HumPRO™ Series Transmit Wait Timeout Minimum Values

MAXTXRETRY - Maximum Transmit Retries

Volatile Address = 0x52; Non-Volatile Address = 0x07

The value in the MAXTXRETRY register sets the number of transmission retries performed if an acknowledgement is not received. If an acknowledgement is not received after the last retry, exception EX_NORFACK is raised. Figure 52 shows examples of the command.

HumPRO™ Series Maximum Transmit Retries						
Read Command				Read Response		
Header	Size	Escape	Address	ACK	Address	Value
0xFF	0x02	0xFE	0x52 0x07	0x06	0x52 0x07	V
Write Command						
Header	Size	Address	Value			
0xFF	0x02	0x52 0x07	V			

Figure 52: HumPRO™ Series Maximum Transmit Retries Command and Response

The time between retries depends on the current baud rate. Figure 53 shows the time between retries based on baud rate. The elapsed transmit and acknowledgment time is $(\text{retries} + 1) \times (\text{PacketTransmitTime} + \text{Timeout})$.

HumPRO™ Series Acknowledgement Timeout Times	
Baud Rate	Timeout Time
9,600	50ms
19,200	50ms
38,400	30ms
57,600	30ms
115,200	30ms

Figure 53: HumPRO™ Series Acknowledgement Timeout Times

ENCRC - CRC Enable

Volatile Address = 0x53; Non-Volatile Address = 0x08

The protocol includes a Cyclic Redundancy Check (CRC) on the received unencrypted packets to make sure that there are no errors. Encrypted packets use a key-based error detection method. Any packets with errors are discarded and not output on the UART. This feature can be disabled if it is desired to perform error checking outside the module. Set the ENCRC register to 0x01 to enable CRC checking, or 0x00 to disable it. The default CRC mode setting is enabled. Figure 54 shows examples of the commands and Figure 55 shows the available values.

HumPRO™ Series CRC Enable							
Read Command				Read Response			
Header	Size	Escape	Address	ACK	Address	Value	
0xFF	0x02	0xFE	0x53 0x08	0x06	0x53 0x08	V	
Write Command							
Header	Size	Address	Value				
0xFF	0x02	0x53 0x08	V				

Figure 54: HumPRO™ Series CRC Enable Command and Response

HumPRO™ Series CRC Enable Register Settings	
V	Mode
0x00	CRC Disabled
0x01	CRC Enabled

Figure 55: HumPRO™ Series CRC Enable Register Settings

Although disabling CRC checking allows receiving packets with errors in the payload, errors in the header can still prevent packets from being output by the module.

BCTRIG - UART Byte Count Trigger

Volatile Address = 0x54; Non-Volatile Address = 0x09

The BCTRIG register determines the UART buffer level that triggers the transmission of a packet. The minimum value is decimal 1 and the maximum value is 192. The default value for this register is 64, which provides a good mix of throughput and latency. At the maximum data rate, a value of 128 optimizes throughput. This register does not guarantee a particular transmission unit size; rather, it specifies the minimum desired size. If there is not enough time left in the channel dwell time before the module must hop to the next channel, for instance, the protocol engine sends as many characters as it can to fill the current channel dwell time, and sends the remaining characters on the next channel. Figure 56 shows examples of the commands.

HumPRO™ Series UART Byte Count Trigger							
Read Command				Read Response			
Header	Size	Escape	Address	ACK	Address	Value	
0xFF	0x02	0xFE	0x54 0x09	0x06	0x54 0x09	V	
Write Command							
Header	Size	Address	Value				
0xFF	0x02	0x54 0x09	V				

Figure 56: HumPRO™ Series UART Byte Count Trigger Command and Response

This trigger can be overridden by enabling the TXPKT option (PKTOPT register, bit 0).

SHOWVER - Show Version

Non-Volatile Address = 0x0A

Setting the SHOWVER register to 0x00 suppresses the start-up message, including firmware version, which is sent out of the UART when the module is reset. A value of 0x01 causes the message to be output after reset. By default, the module start-up message is output. Figure 57 shows examples of the commands and Figure 58 shows the available values.

HumPRO™ Series Show Version							
Read Command				Read Response			
Header	Size	Escape	Address	ACK	Address	Value	
0xFF	0x02	0xFE	0x0A	0x06	0x0A	V	
Write Command							
Header	Size	Address	Value				
0xFF	0x02	0x0A	V				

Figure 57: HumPRO™ Series Show Version Command and Response

HumPRO™ Series Show Version Register Settings	
V	Meaning
0x00	Startup message is NOT output on reset or power-up.
0x01	Startup message is output on reset or power-up. This is a blocking operation, and any incoming UART data is lost during the transmission of this message through the CMD_DATA_OUT line. All UART commands must be sent after this message has completed.

Figure 58: HumPRO™ Series Show Version Register Settings

Example:

HUM-868-PRO v2.3.4

(C) 2015 Linx Technologies Inc. All rights reserved.

ENCSMA - CSMA Enable

Volatile Address = 0x56; Non-Volatile Address = 0x0B

Carrier-Sense Multiple Access (CSMA), also called Listen Before Talk (LBT), is a best-effort transmission protocol that listens to the channel before transmitting a message. See the [Listen Before Talk and Adaptive Frequency Agility](#) section for details. Figure 59 shows examples of the commands and Figure 60 shows the available values.

HumPRO™ Series CSMA Enable							
Read Command				Read Response			
Header	Size	Escape	Address	ACK	Address	Value	
0xFF	0x02	0xFE	0x56 0x0B	0x06	0x56 0x0B	V	
Write Command							
Header	Size	Address	Value				
0xFF	0x02	0x56 0x0B	V				

Figure 59: HumPRO™ Series CSMA Enable Command and Response

HumPRO™ Series CSMA Enable Register Settings	
V	Mode
0x00	Disable CSMA
0x01	Enable CSMA with no duty cycle restrictions
0x02	Enable CSMA with duty cycle restrictions for full ETSI compliance

Figure 60: HumPRO™ Series CSMA Enable Register Settings

Setting this register to 0x00 disables CSMA, causing an immediate transmission when a data packet is ready. The application must limit the duty cycle to <0.1%, since this mode does not conform to ETSI LBT+AFA.

Setting this register to 0x01 enables LBT without the duty cycle constraints. For ETSI conformance, the external device is responsible for ensuring that the transmitter duty cycle is <10%. The module evenly divides transmission time among un-busy channels.

Setting the register to 0x02 enables LBT and a duty cycle limitation of 33.3s per channel per hour to meet ETSI standards for maximum transmitter on time within any 200kHz of spectrum. This is achieved for each channel by limiting the amount of transmit or response time within a 180s bandspread interval.

IDLE - Idle Mode

Volatile Address = 0x58; Non-Volatile Address = 0x0D

The value in the IDLE register sets the operating mode of the transceiver. If the module remains properly powered, and is awakened from a low power mode properly, the volatile registers retain their values. If the volatile registers become corrupted during low power, a software reset is forced and the module reboots.

Awake is the normal operating setting. This is the only setting in which the RF circuitry is able to receive and transmit RF messages.

Sleep disables all circuitry on-board the module. This is the lowest-power setting available for the module.

Please see the [Low Power States](#) section for more details. Figure 61 shows examples of the commands and Figure 62 shows the available values.

HumPRO™ Series Idle Mode						
Read Command				Read Response		
Header	Size	Escape	Address	ACK	Address	Value
0xFF	0x02	0xFE	0x58 0x0D	0x06	0x58 0x0D	V
Write Command						
Header	Size	Address	Value			
0xFF	0x02	0x58 0x0D	V			

Figure 61: HumPRO™ Series Idle Mode Command and Response

HumPRO™ Series Idle Mode Register Settings	
V	Mode
0x00	Awake
0x01	Sleep

Figure 62: HumPRO™ Series Idle Mode Register Settings

WAKEACK - ACK on Wake

Volatile Address = 0x59; Non-Volatile Address = 0x0E

When UART Acknowledge on Wake is enabled, the module sends an ACK (0x06) character out of the CMD_DATA_OUT line after the module resets or wakes from sleep. If the [SHOWVER](#) register is 1, the ACK is sent after the firmware version. This indicates that the module is ready to accept data and commands. A value of 0x01 enables this feature; 0x00 disables it. The default value is 0x01. Figure 63 shows examples of the commands and Figure 64 shows the available values.

HumPRO™ Series ACK on Wake						
Read Command				Read Response		
Header	Size	Escape	Address	ACK	Address	Value
0xFF	0x02	0xFE	0x59 0x0E	0x06	0x59 0x0E	V
Write Command						
Header	Size	Address	Value			
0xFF	0x02	0x59 0x0E	V			

Figure 63: HumPRO™ Series ACK on Wake Command and Response

HumPRO™ Series ACK on Wake Register Settings	
V	Mode
0x00	Disable ACK
0x01	Enable ACK

Figure 64: HumPRO™ Series ACK on Wake Register Settings

UDESTID - User Destination Address

Volatile Address = 0x5A-0x5D; Non-Volatile Address = 0x0F-0x12

These registers contain the address of the destination module when User Addressing mode or Extended User Addressing mode are enabled. User Addressing mode uses bytes 0 and 1 to determine the destination address. Extended User Addressing mode uses all four bytes. These registers are automatically filled with the source address from a received message if the received message address type matches the value in [AUTOADDR](#). Please see the [Addressing Modes](#) section for more details. Each register byte is read and written separately. Figure 65 shows the User Destination ID registers.

HumPRO™ Series User Destination Address Registers			
Name	Volatile Address	Non-Volatile Address	Description
UDESTID3	0x5A	0x0F	MSB of the extended destination address
UDESTID2	0x5B	0x10	Byte 2 of the extended destination address
UDESTID1	0x5C	0x11	Byte 1 of the extended destination address, MSB of the short destination address
UDESTID0	0x5D	0x12	LSB of the extended destination address and short destination address

Figure 65: HumPRO™ Series User Destination Address Registers

USRCID - User Source Address

Volatile Address = 0x5E-0x61; Non-Volatile Address = 0x13-0x16

These registers contain the address of the module when User Addressing mode or Extended User Addressing mode are enabled. User Addressing mode uses bytes 0 and 1 to determine the source address for both transmitted messages and matching received messages. Extended User Addressing mode uses all four bytes. When the [COMPAT](#) register is 0x02 in User Address mode, bytes 3 and 2 must be 0. Please see the [Addressing Modes](#) section for more details. Each register byte is read and written separately. Figure 66 shows the User Source ID registers.

HumPRO™ Series User Source Address Registers			
Name	Volatile Address	Non-Volatile Address	Description
USRCID3	0x5E	0x13	MSB of the extended source address
USRCID2	0x5F	0x14	Byte 2 of the extended source address
USRCID1	0x60	0x15	Byte 1 of the extended source address MSB of the short source address
USRCID0	0x61	0x16	LSB of the extended source address and short source address

Figure 66: HumPRO™ Series User Source Address Registers

UMASK - User ID Mask

Volatile Address = 0x62-0x65; Non-Volatile Address = 0x17-0x1A

These registers contain the user ID mask when User Addressing mode or Extended User Addressing mode are enabled. Please see the [Addressing Modes](#) section for more details. Each register byte is read and written separately.

Figure 67 shows the User ID Mask registers.

HumPRO™ Series User ID Mask Registers			
Name	Volatile Address	Non-Volatile Address	Description
UMASK3	0x62	0x17	MSB of the extended mask
UMASK2	0x63	0x18	Byte 2 of the extended mask
UMASK1	0x64	0x19	Byte 1 of the extended mask MSB of the short mask
UMASK0	0x65	0x1A	LSB of the extended mask and short mask

Figure 67: HumPRO™ Series User ID Mask Registers

DESTDSN - Destination Serial Number

Volatile Address = 0x68-0x6B; Non-Volatile Address = 0x1D-0x20

These registers contain the serial number of the destination module when DSN Addressing Mode is enabled. Please see the [Addressing Modes](#) section for more details. Each register byte is read and written separately.

Figure 68 shows the Destination DSN registers.

HumPRO™ Series Destination DSN Registers			
Name	Volatile Address	Non-Volatile Address	Description
DESTDSN3	0x68	0x1D	MSB of the destination DSN
DESTDSN2	0x69	0x1E	Byte 2 of the destination DSN
DESTDSN1	0x6A	0x1F	Byte 1 of the destination DSN
DESTDSN0	0x6B	0x20	LSB of the destination DSN

Figure 68: HumPRO™ Series Destination DSN Registers

EXMASK - Exception Mask

Volatile Address = 0x6C; Non-Volatile Address = 0x21

The module has a built-in exception engine that can notify the host processor of an unexpected event. When an exception occurs, this register is ANDed with the exception code. A non-zero result causes the EX line to go high. Reading the [EXCEPT](#) register clears the exception and resets the EX line. If the ANDed result is zero, the EX line is not asserted but the exception code is stored in the [EXCEPT](#) register. Please see the [Exception Engine](#) section for more details.

It is recommended to use the [EEXMASK](#) registers instead for new designs.

Figure 69 shows examples of the commands and Figure 70 shows the available values.

HumPRO™ Series Exception Mask						
Read Command				Read Response		
Header	Size	Escape	Address	ACK	Address	Value
0xFF	0x02	0xFE	0x6C 0x21	0x06	0x6C 0x21	V
Write Command						
Header	Size	Address	Value			
0xFF	0x02	0x6C 0x21	V			

Figure 69: HumPRO™ Series Transceiver Exception Mask Command and Response

HumPRO™ Series Example Exception Masks	
V	Exception Name
0x08	Allows only EX_BUFOVFL and EX_RFOVFL to trigger the EX line
0x10	Allows only EX_WRITEREGFAILED to trigger the EX line
0x20	Allows only EX_NORFACK to trigger the EX line
0x40	Allows only EX_BADCRC, EX_BADHEADER, EX_BADSEQID and EX_BADFRAMETYPE exceptions to trigger the EX line
0x60	Allows EX_BADCRC, EX_BADHEADER, EX_BADSEQID, EX_BADFRAMETYPE and EX_NORFACK exceptions to trigger the EX line
0xFF	Allows all exceptions to trigger the EX line

Figure 70: HumPRO™ Series Transceiver Example Exception Masks

CMDHOLD - $\overline{\text{CMD}}$ Halts Traffic

Volatile Address = 0x6E; Non-Volatile Address = 0x23

A CMDHOLD register setting of 0x01 causes the module to store incoming RF traffic (up to the RF buffer size) while the $\overline{\text{CMD}}$ line is low. When the $\overline{\text{CMD}}$ line is returned high, the module outputs all buffered data. A register value of 0 allows received bytes to be output on the UART immediately with $\overline{\text{CRESP}}$ high to indicate that the bytes are received data. See [Using the Command Response \(\$\overline{\text{CRESP}}\$ \) Line](#) section for details. This register setting is overridden when PKOPT:RXPKT=1.

Figure 71 shows examples of the commands and Figure 72 shows the available values.

HumPRO™ Series $\overline{\text{CMD}}$ Halts Traffic						
Read Command				Read Response		
Header	Size	Escape	Address	ACK	Address	Value
0xFF	0x02	0xFE	0x6E 0x23	0x06	0x6E 0x23	V
Write Command						
Header	Size	Address	Value			
0xFF	0x02	0x6E 0x23	V			

Figure 71: HumPRO™ Series Transceiver $\overline{\text{CMD}}$ Halts Traffic Command and Response

HumPRO™ Series $\overline{\text{CMD}}$ Halts Traffic Register Settings	
V	Mode
0x00	Disable Halt (received data is sent to the UART immediately)
0x01	Enable Halt (received data is sent when the $\overline{\text{CMD}}$ line is high)

Figure 72: HumPRO™ Series $\overline{\text{CMD}}$ Halts Traffic Register Settings

COMPAT - Compatibility Mode

Volatile Address = 0x70; Non-Volatile Address = 0x25

Compatibility mode allows some HumPRO™ Series modules to communicate with older modules. This does not apply to HUM-868-PRO modules. Figure 73 shows examples of the commands and Figure 74 shows the available values.

HumPRO™ Series Compatibility Mode						
Read Command				Read Response		
Header	Size	Escape	Address	ACK	Address	Value
0xFF	0x02	0xFE	0x70 0x25	0x06	0x70 0x25	V
Write Command						
Header	Size	Address	Value			
0xFF	0x02	0x70 0x25	V			

Figure 73: HumPRO™ Series Transceiver Compatibility Mode Command and Response

HumPRO™ Series Compatibility Mode Register Settings	
V	Mode
0x00	Enable Relaxed Addressing Operation
0x02	Enable Normal Addressing Operation
0x03	Enable Network Addressing Operation

Figure 74: HumPRO™ Series Compatibility Mode Register Settings

AUTOADDR - Auto Addressing

..... Volatile Address = 0x71; Non-Volatile Address = 0x26

When the AUTOADDR feature is enabled, the module reads the Source Address from a received packet and uses it to fill the Destination Address registers (UDESTID or DESTDSN, depending on the addressing mode of the received message). This ensures that a response is sent to the device that transmitted the original message. The response ADDMODE should be the same as ADDMODE used to send the original message.

The non-volatile register only uses the lower 4 bits to configure the automatic addressing. The upper 4 bits must be set to 0.

The volatile register is split in half with the lower 4 bits configuring the automatic addressing, the same as the non-volatile register. The upper 4 bits indicate the type of the last received packet satisfying the AUTOADDR mask. These bits must be written as 0. This indication is the same as the Addressing Mode register setting. These bits are not used by the module and are only written by the module after successfully receiving a packet.

As an example, if AUTOADDR is set to 0x0F (Any Auto Address) and a DSN packet is received from another module, then AUTOADDR reads back as 0x4F. The lower 4 bits (0xF) indicate that the module is set to any auto address (0xF). The upper 4 bits (0x4) indicate that the packet that was just received was a DSN Addressing Mode packet.

Figure 75 summarizes the configuration values for the lower 4 bits of the register.

Figure 76 shows the Addressing Mode values that the module writes to the upper 4 bits after successfully receiving a packet.

HumPRO™ Series Auto Addressing Register Settings		
Auto Address Value	Meaning	Action
0x00	Auto Addressing disabled	Destination Registers not populated
0x04	DSN Auto Address	Auto-populates DSN Address Destination Register Only
0x06	User Auto Address Mode	Auto-populates User Address Destination Register
0x07	Extended User Auto Address Mode	Auto-populates Extended User Address Destination Register
0x0F	Any Auto Address Mode	Auto-populates DSN Destination or User Address Destination, depending on the received message type.

Figure 75: HumPRO™ Series Transceiver Auto Addressing Register Settings

HumPRO™ Series Auto Addressing Mode Indicator	
Addressing Mode	Meaning
0x4	DSN Addressing Mode
0x6	User Addressing Mode
0x7	Extended User Addressing Mode

Figure 76: HumPRO™ Series Transceiver Auto Addressing Mode Indicator

MYDSN - Local Device Serial Number

Non-Volatile Address = 0x34-0x37

These registers contain the factory-programmed read-only Device Serial Number. This address is unique for each module and is included in all packet types as a unique origination address.

Figure 77 shows the Device Serial Number registers.

HumPRO™ Series DSN Registers		
Name	Non-Volatile Address	Description
MYDSN3	0x34	MSB of the serial number
MYDSN2	0x35	Byte 2 of the serial number
MYDSN1	0x36	Byte 1 of the serial number
MYDSN0	0x37	LSB of the serial number

Figure 77: HumPRO™ Series DSN Registers

CUSTID - Customer ID

Non-Volatile Address = 0x39-0x3A

These registers contain the factory-programmed customer ID. A unique value is assigned to a specific customer and that value is programmed into that customer's modules. The unencrypted User and Extended User Addressing modes use these bytes as part of the addressing. The unique value ensures that the custom modules will not communicate with any other systems. Contact Linx for details. Figure 78 shows the Customer ID registers.

HumPRO™ Series Customer ID Registers		
Name	Non-Volatile Address	Description
CUSTID1	0x39	MSB of the customer ID
CUSTID0	0x3A	LSB of the customer ID

Figure 78: HumPRO™ Series Transceiver Customer ID Registers

CSRSSI - Carrier Sense Minimum RSSI

Non-Volatile Address = 0x3F

This value is the minimum RSSI that causes the module to wait for a clear channel when CSMA is enabled. Figure 79 shows examples of the commands.

HumPRO™ Series Carrier Sense Minimum RSSI						
Read Command				Read Response		
Header	Size	Escape	Address	ACK	Address	Value
0xFF	0x02	0xFE	0x3F	0x06	0x3F	V
Write Command						
Header	Size	Address	Value			
0xFF	0x02	0x3F	V			

Figure 79: HumPRO™ Series Transceiver Carrier Sense Minimum RSSI Command and Response

The value is a negative number in two's complement from -128 (0x80) to -1 (0xff). The default value is -92dBm, which is the maximum limit for ETSI compliance.

Warning: The CRSSI value can have a significant impact on the performance of the module. Setting it too low could prevent the module from ever transmitting. Setting it too high can result in transmission collisions. Care must be taken if this value is adjusted.

RELEASE - Release Number

Non-Volatile Address = 0x78

This register contains a number designating the firmware series and hardware platform. Figure 80 shows examples of the commands and Figure 81 lists current releases to date.

HumPRO™ Series Release Number						
Read Command				Read Response		
Header	Size	Escape	Address	ACK	Address	Value
0xFF	0x02	0xFE	0x78	0x06	0x78	V

Figure 80: HumPRO™ Series Transceiver Release Number Command and Response

HumPRO™ Series Release Number Register Settings	
V	Release Number
0x20	HUM-900-PRO
0x22	HUM-868-PRO

Figure 81: HumPRO™ Series Transceiver Release Number Register Settings

A more detailed firmware version is available for versions 0x20 and above in the FWVER register.

EXCEPT - Exception Code

Volatile Address = 0x79

The module has a built-in exception engine that can notify the host processor of an unexpected event. If an exception occurs, the exception code is stored in this register. Reading from this register clears the exception and resets the EX line. If an exception occurs before the previous exception code is read, the previous value is overwritten. Please see the [Exception Engine](#) section for more details.

It is recommended to use the [EEXFLAG](#) registers for new designs.

Figure 82 shows examples of the commands and Figure 83 shows the available values.

HumPRO™ Series Exception Code						
Read Command				Read Response		
Header	Size	Escape	Address	ACK	Address	Value
0xFF	0x02	0xFE	0x79	0x06	0x79	V

Figure 82: HumPRO™ Series Transceiver Exception Code Command and Response

HumPRO™ Series Transceiver Exception Codes		
V	Exception Name	Description
0x08	EX_BUFOVFL	Internal UART buffer overflowed.
0x09	EX_RFOVFL	Internal RF packet buffer overflowed.
0x13	EX_WRITEREGFAILED	Attempted write to register failed.
0x20	EX_NORFACK	Acknowledgement packet not received after maximum number of retries.
0x40	EX_BADCRC	Bad CRC detected on incoming packet.
0x42	EX_BADHEADER	Bad CRC detected in packet header.
0x43	EX_BADSEQID	Sequence ID was incorrect in ACK packet.
0x44	EX_BADFRAMETYPE	Unsupported frame type specified.

Figure 83: HumPRO™ Series Transceiver Exception Codes

PRSSI - Last Good Packet RSSI

Volatile Address = 0x7B

This register holds the received signal strength in dBm of the last successfully received packet. A successful packet reception is one that causes payload data to be output on the UART interface. The value in this register is overwritten each time a new packet is successfully processed. The register value is an 8-bit signed integer representing the RSSI in dBm. It is accurate to ± 3 dB.

HumPRO™ Series Last Good Packet RSSI							
Read Command				Read Response			
Header	Size	Escape	Address	ACK	Address	Value	
0xFF	0x02	0xFE	0x7B	0x06	0x7B	V	

Figure 84: HumPRO™ Series Transceiver Last Good Packet RSSI Command and Response

ARSSI - Ambient RSSI

Volatile Address = 0x7C

This register returns the ambient receive signal strength on the current channel in dBm. The signal strength is measured as soon as the command is received. The register value is an 8-bit signed integer representing the RSSI in dBm. It is accurate to ± 3 dB at the high RF data rate, and +3 to -20 dB at the low RF data rate. The channel being read may be any of the channels in the selected hopping sequence.

HumPRO™ Series Ambient RSSI							
Read Command				Read Response			
Header	Size	Escape	Address	ACK	Address	Value	
0xFF	0x02	0xFE	0x7C	0x06	0x7C	V	

Figure 85: HumPRO™ Series Transceiver Ambient RSSI Command and Response

FWVER - Firmware Version

Non-Volatile Address = 0xC0 - 0xC3

These read-only registers contain the firmware version number currently on the module. Each byte is a hexadecimal value: 12 03 01 00 indicates version 18.3.1.0. Each register byte is read separately. Figure 86 shows the Firmware Version registers.

HumPRO™ Series Firmware Version Registers		
Name	Non-Volatile Address	Description
FWVER3	0xC0	Major version number
FWVER2	0xC1	Minor version number
FWVER1	0xC2	Incremental version number
FWVER0	0xC3	Suffix

Figure 86: HumPRO™ Series Firmware Version Registers

NVCYCLE - Non-Volatile Refresh Cycles

Non-Volatile Address = 0xC4-0xC5

These read-only non-volatile registers contain the number of lifetime refresh cycles performed for the non-volatile memory. The minimum lifetime refreshes is 2,000 refresh cycles. Beyond this the refreshes may not be complete and the module's operation can become unpredictable.

HumPRO™ Series Non-Volatile Refresh Cycles Registers		
Name	Non-Volatile Address	Description
NVCYCLE1	0xC4	MSB of the number of refresh cycles
NVCYCLE0	0xC5	LSB of the number of refresh cycles

Figure 87: HumPRO™ Series Non-Volatile Refresh Cycles Registers

Between 8 and 150 non-volatile write operations can be made before a refresh cycle is necessary. Writing the registers from lowest to highest address maximizes the number of write operations per refresh cycle.

It is recommended to write the desired default values to non-volatile memory and use the volatile registers for values that change frequently.

These registers show the total number of refresh cycles that have occurred. This gives an indication of the remaining life expectancy of the memory. Figure 87 shows the Non-Volatile Refresh Cycles registers.

LSTATUS - Output Line Status

Volatile Address = 0xC6

This register contains the logic states of the output indicator lines, providing information to the host processor while using fewer GPIO lines.

HumPRO™ Series Output Line Status								
Read Command					Read Response			
Header	Size	Escape	Escape	Address	ACK	Address	Value	
0xFF	0x03	0xFE	0xFE	0x46	0x06	0xC6	LSTATUS	

Figure 88: HumPRO™ Series Transceiver Output Line Status Command and Response

Each bit in the byte that is returned by the read represents the logic state of one of the output indicator lines. Figure 89 shows which line each bit represents.

HumPRO™ Series Output Line Status LSTATUS Values	
LSTATUS Bit	Line Status
0	EX – Exception, 1 = exception has occurred
1	PA_EN – PA Enable, 1 = the transmitter is active
2	LNA_EN – LNA Enable, 1 = the receiver is active
3	$\overline{\text{CTS}}$ – Clear To Send, 1 = incoming data buffer near full
4	MODE_IND – Mode Indicator, 1 = RF data transfer is active (TX or RX)
5	BE – Buffer Empty, 1 = UART buffer is empty
6	Reserved
7	Reserved

Figure 89: HumPRO™ Series Output Line Status LSTATUS Values

CMD - Command Register

Volatile Address = 0xC7

This volatile write-only register is used to issue special commands.

HumPRO™ Series Command Register				
Write Command				
Header	Size	Escape	Address	Value
0xFF	0x03	0xFE	0x47	V

Figure 90: HumPRO™ Series Transceiver Command Register Command and Response

Value V is chosen from among the options in Figure 91.

HumPRO™ Series CMD Values	
CMD Value	Operation
0x01	SENDP – Send Packet
0x02	GETPH – Get Packet Header
0x03	GETPD – Get Packet Data
0x04	GETPHD – Get Packet Header and Data
0x05	CLRRXP – Clear Received Packet
0x06	CLROB – Clear Outbound Buffer
0x07	CLRIB – Clear Input Buffer
0x10	JOINCTL – Join Process Control
0x11	WRKEY – Write Key
0x12	CLRKEY – Clear Key
0x13	RLDKEY – Reload Key
0x20 0xAA 0xBB	NVRESET – Reset non-volatile registers to factory default

Figure 91: HumPRO™ Series Command Register Values

The **Send Packet** command starts data transmission. Operation differs depending on whether option TXPKT is set in the PKTOPT register.

- TXPKT = 0; this command operates the same as a data timeout with DATATO. All waiting data, up to the maximum allowed in the remaining channel time, is transmitted.
- TXPKT = 1; this command marks the end of an explicit packet in the outgoing buffer. All bytes in the packet are transmitted together. Following bytes are sent in the next packet. The max packet length is 192 bytes. Multiple packets can be queued with this command.

The **Get Packet Header** command returns the received packet header using a received packet transfer cycle (see the [Receiving Packets](#) section). The header is discarded after transfer. This command is normally issued after receiving an RXWAIT exception. The packet data can be read after completion of the header transfer. If the data is not read before this command is issued a second time, then the packet data is discarded and the header for the following packet is returned. A NACK response is returned if option RXPKT is disabled in the PKTOPT register or the previous GETPx command was not completed.

The **Get Packet Data** command returns the received packet data using a received packet transfer cycle. If the packet header is not read first, then it is discarded. The packet data is then discarded after transfer. A NACK response is returned if option RXPKT is disabled in the PKTOPT register or the previous GETPx command was not completed.

The **Get Packet Header and Data** command returns the received packet header, followed by the packet data using a received packet transfer cycle. The packet is discarded after transfer. A NACK response is returned if option RXPKT is disabled in the PKTOPT register or the previous GETPx command was not completed.

The **Clear Received Packet** command removes the next unread packet from the RF incoming queue if RXPKT is enabled in the PKTOPT register.

If the packet header was read but not the data, this command causes the data to be discarded. Although not required before reading the next packet's header, it frees buffer space for more or longer messages.

If a previous GETPx command did not deliver all the associated data, this command removes the undelivered data and terminates the previous GETPx command.

If option RXPKT is disabled this command discards all received data which has not been delivered.

The **Clear Outbound Buffer** command cancels any transmission in progress and clears the buffer of data to be transmitted.

The **Clear Input Buffer** command discards all RF-received bytes and clears the EX_RXWAIT flag.

The **Join Process Control** command allows the software to initiate or stop the secure [JOIN process](#). It has the following subcommands.

HumPRO™ Series JOINCTL Subcommand Values	
Subcommand Value	Operation
0	Halt JOIN operation
1	Generate a random network key and address. This sets the module as the network administrator (SECOPT:KEYRCV=0)
2	Perform the JOIN operation with another module

Figure 92: HumPRO™ Series JOINCTL Subcommand Values

These operations are equivalent to the push-button initiated operation. If a JOIN operation is started by the serial command (CMD:JOINCTL[2]), push-button operation is ignored until the JOIN operation finishes.

Register write operations are inhibited when a JOIN process is active except that a Halt JOIN command is never inhibited. A Halt JOIN operation completes before the ACK is sent.

When the JOIN operation is started the KEYRCV flag in the [SECOPT](#) register determines whether the module is an administrator or node and whether a key can be sent or changed. The JOIN process uses and modifies the non-volatile address registers. After a successful JOIN, the modified non-volatile registers are copied to the corresponding volatile registers.

The **Write Key** command writes a 16-byte AES key to the selected key register. As with most of the registers, the encryption key has both volatile and non-volatile registers. The volatile register is used during run time, but is lost on a power cycle or reset. When the module powers up, the volatile register is loaded from the non-volatile register. This makes the non-volatile register value the default on power-up.

The key value of all zero bytes is reserved as a “no key” indication.

HumPRO™ Series Write Key Command								
Write Command								
Header	Size	Escape	Address	Value	KeyN	Key0	...	Key15
0xFF	Size	0xFE	0x47	0x11	KeyN	Key0	...	Key15

Figure 93: HumPRO™ Series Transceiver Write Key Command

Figure 93 shows the command for writing the AES key to the module.

If KeyN is 0x01, the command writes to the volatile key register. If it is 0x02, it writes to the non-volatile key register.

The **Clear Key** command sets the selected key to all zeros. Figure 94 shows the structure of this command.

HumPRO™ Series Clear Key Command					
Write Command					
Header	Size	Escape	Address	Value	KeyN
0xFF	0x04	0xFE	0x47	0x12	KeyN

Figure 94: HumPRO™ Series Transceiver Clear Key Command

If KeyN is 0x01, the command clears the volatile key registers. If it is 0x02, it clears the non-volatile key registers.

The **Reload Key** command copies the key in non-volatile memory (NKN) to the volatile location (NKV). This allows a sophisticated system to change the keys during operation and quickly revert back to the default key.

The **Non-volatile Reset** command (FF 07 FE 47 20 FE 2A FE 3B) sets all non-volatile registers to their default values. When the configuration is reset, the following message, shown in quotes, is sent out the UART at the current baud rate, then the module is reset, similar to a power cycle:

“\r\nConfiguration Reset\r\n”.

This reset can also be done by toggling the PB line as described in the [Restore Factory Defaults](#) section.

SECSTAT - Security Status

Volatile Address = 0xC9

This volatile read-only register provides status of the security features.

HumPRO™ Series Security Status								
Read Command					Read Response			
Header	Size	Escape	Escape	Address	ACK	Address	Value	
0xFF	0x03	0xFE	0xFE	0x49	0x06	0xC9	V	

Figure 95: HumPRO™ Series Transceiver Security Status Command and Response

The command returns a single byte. Figure 96 shows the meanings of the bits in the returned value byte.

HumPRO™ Series Security Status Value	
Bit	Status
0	Reserved
1	0 = No volatile key is set 1 = A volatile key is set
2	0 = No non-volatile key is set 1 = A non-volatile key is set
3	Reserved
4	Reserved
5	Reserved
6	Reserved
7	Reserved

Figure 96: HumPRO™ Series Security Status Values

JOINST - Join Status

Volatile Address = 0xCA

This volatile read-only register shows the current or previous state of join activity since the module was last reset.

HumPRO™ Series Join Status								
Read Command					Read Response			
Header	Size	Escape	Escape	Address	ACK	Address	Value	
0xFF	0x03	0xFE	0xFE	0x4A	0x06	0xCA	V	

Figure 97: HumPRO™ Series Transceiver Join Status Command and Response

The command returns a single byte. Figure shows the meanings of the returned value byte.

HumPRO™ Series Join Status Value	
Bit	Status
0 - 5	<p>Last Join Result (decimal):</p> <p>Last Operation Successful 0x00: Module unpaired since restart 0x01: New key generated 0x02: Successfully sent address to another unit 0x03: Successfully sent address and key to another unit 0x04: Successfully obtained key from administrator 0x05: Successfully obtained address from administrator 0x06: Successfully obtained key and address from administrator 0x07: New address generated without key 0x08: New key generated without address</p> <p>Last Operation Failed 0x0A: Fail: operation canceled 0x0B: Fail: timeout 0x0C: Fail: Invalid Generate Key and Address request 0x0D: Fail: Assignment message didn't contain key 0x0E: Fail: Administrator has no key to send when SECOPT:PSHARE=1 0x0F: Fail: Administrator has no address to send 0x10: Fail: Inconsistent Network Address Registers USRC, UMASK, LASTNETAD 0x11: Fail: LASTNETAD overflow 0x12: Fail: GET_KEY key and address change disabled.</p> <p>Current Operation 0x20: Detecting PB sequence 0x21: Waiting for joining unit 0x22: Another joining unit detected. Joining is in progress.</p>
6	+0x64: JOINACT – MODE_IND is active with pairing status, serial write operations are inhibited

Figure 98: HumPRO™ Series Transceiver Join Status Value

EEXFLAG - Extended Exception Flags

Volatile Address = 0xCD - 0xCF

These volatile registers contain flags for various events. Similar to the EXCEPT register, they provide a separate bit for each exception.

HumPRO™ Series Extended Exception Flags Registers		
Name	Volatile Address	Description
EEXFLAG2	0xCD	Byte 2 of the extended exception flags
EEXFLAG1	0xCE	Byte 1 of the extended exception flags
EEXFLAG0	0xCF	LSB of the extended exception flags

Figure 99: HumPRO™ Series Transceiver Extended Exception Code Registers

When an exception occurs, the associated bit is set in this register. If the corresponding bit in the EEXMASK is set and EXMASK is zero, the EX status line is set. Reading an EEXFLAG register does not clear the register.

Writing to an EEXFLAG register causes the register to be set to the BIT_AND(current_value, new_value). This provides a way of clearing bits that have been serviced without clearing a bit that has been set since the flag register was read. This prevents a loss of notification of an exception.

Register bits can only be cleared, not set, from the write command though some flags are also cleared internally. Unless otherwise noted, exceptions are cleared by writing a zero to the corresponding register bit.

Flag **EX_TXDONE** is set when a data packet has been transmitted. If the packet was sent with acknowledgement enabled, this flag indicates that the acknowledgment has also been received.

Flag **EX_RXWAIT** is 1 when there are buffered incoming data bytes which have not been sent to the UART. It is cleared by reading or discarding all data bytes.

Flag **EX_UNENCRYPT** is 1 when a received packet is not encrypted. This can only occur when SECOPT:EN_UNC=1.

Flag **EX_SEQDEC** is 1 when a received encrypted packet has a smaller sequence number than the previously received packet. Possible causes are an attempt to replay a previous message by an attacker, receiving a message from a different transmitter or restarting the transmitter.

Flag **EX_SEQSKIP** is 1 when a received encrypted packet has a sequence number that is more than one higher than the previously received packet. Possible causes are an attempt to replay a previous message by an attacker, receiving a message from a different transmitter or restarting the transmitter.

HumPRO™ Series Transceiver Extended Exception Codes		
Bit	Exception Name	Description
EEXFLAG0 (0xCF)		
0	EX_BUFOVFL	Internal UART buffer overflowed.
1	EX_RFOVFL	Internal RF packet buffer overflowed.
2	EX_WRITEREGFAILED	Attempted write to register failed.
3	EX_NORFACK	Acknowledgement packet not received after maximum number of retries.
4	EX_BADCRC	Bad CRC detected on incoming packet.
5	EX_BADHEADER	Bad CRC detected in packet header.
6	EX_BADSEQID	Sequence ID was incorrect in ACK packet.
7	EX_BADFRAMETYPE	Unsupported frame type specified.
EEXFLAG1 (0xCE)		
0	EX_TXDONE	A data packet has been transmitted.
1	EX_RXWAIT	Received data bytes are waiting to be read.
2	EX_UNENCRYPT	Received packet was not encrypted. This can only occur when SECOPT:EN_UNC=1.
3	EX_SEQDEC	Received encrypted packet sequence number is less than previous.
4	EX_SEQSKIP	Received encrypted sequence number is more than one higher the previous sequence number.
5	EX_JOIN	A JOIN operation has been started, which can result in register changes and write lockouts.
6 - 7	Reserved	
EEXFLAG2 (0xCD)		
0 - 7	Reserved	

Figure 100: HumPRO™ Series Transceiver Extended Exception Codes

PKTOPT - Packet Options

Volatile Address = 0xD3; Non-Volatile Address = 0x83

This register selects options for transferring packet data.

HumPRO™ Series Packet Options								
Read Command					Read Response			
Header	Size	Escape	Escape	Address	ACK	Address	Value	
0xFF	0x03	0xFE	0xFE	0x53 0x03	0x06	0xD3 0x83	V	
Write Command								
Header	Size	Escape	Address	Value				
0xFF	0x03	0xFE	0x53 0x03	V				

Figure 101: HumPRO™ Series Transceiver Packet Options Command and Response

Each bit in the register sets an option as shown in Figure 102.

HumPRO™ Series Transceiver Packet Option Codes		
Bit	Name	Description
0	TXPKT	Packet Transmit
1	TXnCMD	Transmit when nCMD Lowered
2	RXPKT	Packet Receive
3	RXP_CTS	Use CTS for RXPKT Transfer
4 - 7	Reserved	Reserved (must be 0)

Figure 102: HumPRO™ Series Transceiver Packet Option Codes

The **TXPKT** option allows the module to transmit data in explicit packets.

- TXPKT = 0 (default); a packet transmission is enabled when the number of waiting bytes reaches BCTRIG bytes, the time since the last received byte exceeds DATATO ms, the number of waiting bytes exceeds the number that can be sent within the remaining slot time, or a Send Packet command is written to the CMD register.
- TXPKT = 1; all bytes written to the module are held until a SENDP command is written to the CMD register or the CMD line is lowered with TXnCMD = 1. The DATATO or BCTRIG conditions are ignored with this option. The transmitted packet consists of the bytes in the buffer at the time a packet is triggered, even if more data bytes are received before the packet can be sent.

Multiple outgoing packets can be buffered. Changing this option clears the incoming buffer, losing un-transmitted or unacknowledged data.

When **TXnCMD** is 1, lowering the $\overline{\text{CMD}}$ line has the same effect as writing the SENDP command to the CMD register, triggering buffered data to be transmitted. Packet grouping is affected by option TXPKT. The minimum low time on the $\overline{\text{CMD}}$ line to terminate the packet is given in the Electrical Specifications.

When **RXPKT** is 1, incoming packets are held until a GETPH, GETPD, or GETPHD command is written to the CMD register. Transfer uses a Packet Receive transfer. The CMDHOLD setting has no effect.

When **RXPKT** is 0, incoming UART data is delivered without headers. The data flow is controlled by the CMDHOLD setting.

When **RXP_CTS** is 1, the $\overline{\text{CTS}}$ line is used for the status line during a Packet Receive transfer and not for controlling data flow into the module. When it is 0, $\overline{\text{CTS}}$ is used for flow control and CRESP is used for the status line.

SECOPT - Security Options

Volatile Address = 0xD4; Non-Volatile Address = 0x84

This register selects options for security features.

HumPRO™ Series Security Options									
Read Command					Read Response				
Header	Size	Escape	Escape	Address	ACK	Address	Value		
0xFF	0x03	0xFE	0xFE	0x54 0x04	0x06	0xD4 0x84	V		
Write Command									
Header	Size	Escape	Address		Value				
0xFF	0x03	0xFE	0x54 0x04		V				

Figure 103: HumPRO™ Series Transceiver Packet Options Command and Response

Each bit in the register sets an option as shown in Figure 104. Unlike other registers, the non-volatile register (0x84) affects all Join operations. The EN_UNENC bit in the volatile register affects data packet reception.

HumPRO™ Series Transceiver Security Option Codes		
Bit	Name	Description
0	PB_RESET	Permit factory reset from PB input sequence
1	PSHARE	Permit key sharing
2	PGKEY	Permit clearing key and changing key
3	CHGADDR	Permit changing an address
4	KEYRCV	1: Receive key and address during JOIN operation (node) 0: Send key and address during JOIN operation (admin)
5	EN_UNENC	Enable receiving unencrypted packets
6	Reserved	Reserved (must be 1)
7	EN_CHANGE	Enable changes to security options

Figure 104: HumPRO™ Series Transceiver Security Option Codes

When PB_RESET is 1 the Factory Reset function is enabled from the PB input. This allows a user to reset the module configurations back to the factory defaults with 4 short presses and a 3 second hold of a button connected to the PB input.

When PSHARE is 1 the Share Network Key function is enabled during the JOIN process. This allows an administrator to share the encryption key it created. When 0, a JOIN process sends the network address, but no key.

When PGKEY is 1 the JOIN process is allowed to change or clear the network key. The key can always be changed through serial commands.

When CHGADDR is 1 the JOIN process is allowed to generate a random network address if the module is an administrator. If the module is a node it is allowed to accept an address assignment from the administrator.

When KEYRCV is 1 the module is set to receive a network key from an administrator and act as a node. When it is 0, the module is set as an administrator and sends a network key and assigns an address to the node.

In order for this bit to change from 1 to 0, both volatile and non-volatile copies of the network key must be cleared, preventing nodes from being manipulated to transmit the key. This bit is cleared by the GENERATE_KEY push-button function.

When EN_UNENC is 1 the module accepts unencrypted packets. If this bit is 0, unencrypted received packets are ignored.

When EN_CHANGE is 1, changes are permitted to the SECOPT register, except as noted for KEYRCV changes.

Clearing this bit prohibits the following SECOPT changes to enhance security:

1. Changing PSHARE from 0 to 1
2. Changing EN_CHANGE from 0 to 1.
3. Changing EN_UNENC from 0 to 1.

An attempt to make a prohibited change causes a NACK command response.

When EN_CHANGE is 0, these restrictions can only be removed by resetting the module configuration to the factory default.

EEXMASK - Extended Exception Mask

Volatile Address = 0xD0-0xD2; Non-Volatile Address = 0x80-0x82

These registers contain a mask for the events in EEXFLAG, using the same offset and bit number.

HumPRO™ Series Extended Exception Mask Registers			
Name	Volatile Address	Non-Volatile Address	Description
EEXMASK2	0xD0	0x80	Byte 2 of the extended exception mask
EEXMASK1	0xD1	0x81	Byte 1 of the extended exception mask
EEXMASK0	0xD2	0x82	LSB of the extended exception mask

Figure 105: HumPRO™ Series Transceiver Extended Exception Mask Registers

To use this value, register EXMASK must be zero. If EXMASK is non-zero, this register has no effect on the EX line.

When an exception bit is set in EEXFLAG, the corresponding EEXMASK bit is set, and EXMASK is zero, the EX status line is set, otherwise the EX line is reset. Mask bits for unassigned flags should be zero for future compatibility.

LASTNETAD - Last Network Address Assigned

Non-Volatile Address = 0x8C-0x8F

These bytes contain the last address assigned using the JOIN process.

When a new unit joins the network, it is assigned the next address and this value is incremented in the administrator. It is initially set to the administrator address when a network key is generated.

HumPRO™ Series Extended Exception Mask Registers		
Name	Non-Volatile Address	Description
LASTNETAD3	0x8C	MSB of the last network address assigned
LASTNETAD2	0x8D	Byte 2 of the last network address assigned
LASTNETAD1	0x8E	Byte 1 of the last network address assigned
LASTNETAD0	0x8F	LSB of the last network address assigned

Figure 106: HumPRO™ Series Transceiver Extended Exception Mask Registers

Typical Applications

Figure 107 shows a typical circuit using the HumPRO™ Series transceiver.

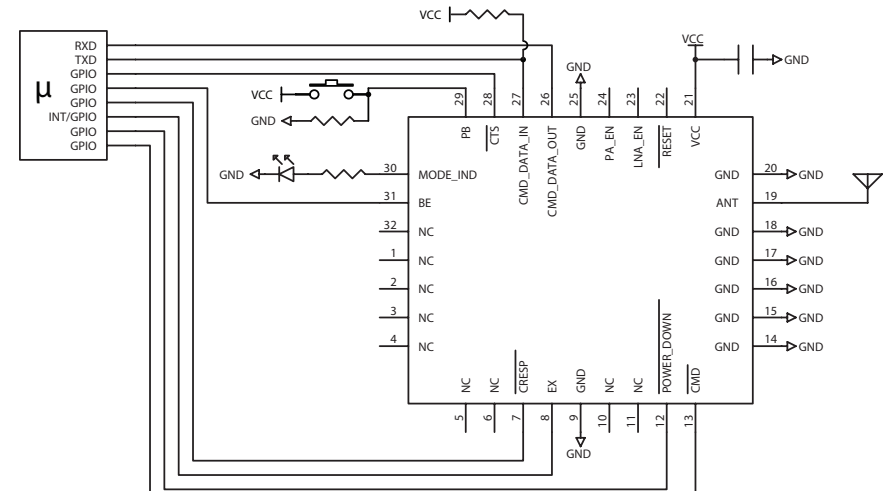

Figure 107: HumPRO™ Series Transceiver Basic Application Circuit

An external microcontroller provides data and configuration commands. Its UART (TXD, RXD) is connected to the module's UART (CMD_DATA_IN, CMD_DATA_OUT). The $\overline{\text{CTS}}$ line is monitored for flow control. GPIOs on the microcontroller are connected to lines on the module:

It monitors the $\overline{\text{CRESP}}$ line to know when the data coming out of the module is transmitted data or a response to a command.

It monitors the EX line to know if there is an error. This line may be connected to an interrupt line for faster response.

It controls the $\overline{\text{POWER_DOWN}}$ line to place the module into a low power state.

It controls the $\overline{\text{CMD}}$ line to toggle between configuration commands and data to be transmitted over the air.

The MODE_IND line is connected to an LED for visual indication that the module is active.

The PB line is connected to a pushbutton that takes the line to VCC when it is pressed. A resistor pulls the line to ground when the button is not pressed.

Power Supply Requirements

The module does not have an internal voltage regulator, therefore it requires a clean, well-regulated power source. The power supply noise should be less than 20mV. Power supply noise can significantly affect the module's performance, so providing a clean power supply for the module should be a high priority during design.

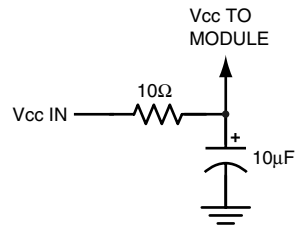

Figure 108: Supply Filter

A 10Ω resistor in series with the supply followed by a 10μF tantalum capacitor from V_{cc} to ground helps in cases where the quality of supply power is poor (Figure 108). This filter should be placed close to the module's supply lines. These values may need to be adjusted depending on the noise present on the supply line.

Antenna Considerations

The choice of antennas is a critical and often overlooked design consideration. The range, performance and legality of an RF link are critically dependent upon the antenna. While adequate antenna performance can often be obtained by trial and error methods, antenna design and matching is a complex task. Professionally designed antennas such as those from Linx (Figure 109) help ensure maximum performance and FCC and other regulatory compliance.



Figure 109: Linx Antennas

Linx transmitter modules typically have an output power that is higher than the legal limits. This allows the designer to use an inefficient antenna such as a loop trace or helical to meet size, cost or cosmetic requirements and still achieve full legal output power for maximum range. If an efficient antenna is used, then some attenuation of the output power will likely be needed.

It is usually best to utilize a basic quarter-wave whip until your prototype product is operating satisfactorily. Other antennas can then be evaluated based on the cost, size and cosmetic requirements of the product. Additional details are in Application Note AN-00500.

Interference Considerations

The RF spectrum is crowded and the potential for conflict with unwanted sources of RF is very real. While all RF products are at risk from interference, its effects can be minimized by better understanding its characteristics.

Interference may come from internal or external sources. The first step is to eliminate interference from noise sources on the board. This means paying careful attention to layout, grounding, filtering and bypassing in order to eliminate all radiated and conducted interference paths. For many products, this is straightforward; however, products containing components such as switching power supplies, motors, crystals and other potential sources of noise must be approached with care. Comparing your own design with a Linx evaluation board can help to determine if and at what level design-specific interference is present.

External interference can manifest itself in a variety of ways. Low-level interference produces noise and hashing on the output and reduces the link's overall range.

High-level interference is caused by nearby products sharing the same frequency or from near-band high-power devices. It can even come from your own products if more than one transmitter is active in the same area. It is important to remember that only one transmitter at a time can occupy a frequency, regardless of the coding of the transmitted signal. This type of interference is less common than those mentioned previously, but in severe cases it can prevent all useful function of the affected device.

Although technically not interference, multipath is also a factor to be understood. Multipath is a term used to refer to the signal cancellation effects that occur when RF waves arrive at the receiver in different phase relationships. This effect is a particularly significant factor in interior environments where objects provide many different signal reflection paths. Multipath cancellation results in lowered signal levels at the receiver and shorter useful distances for the link.

Pad Layout

The pad layout diagrams below are designed to facilitate both hand and automated assembly. Figure 110 shows the footprint for the smaller version and Figure 111 shows the footprint for the encapsulated version.

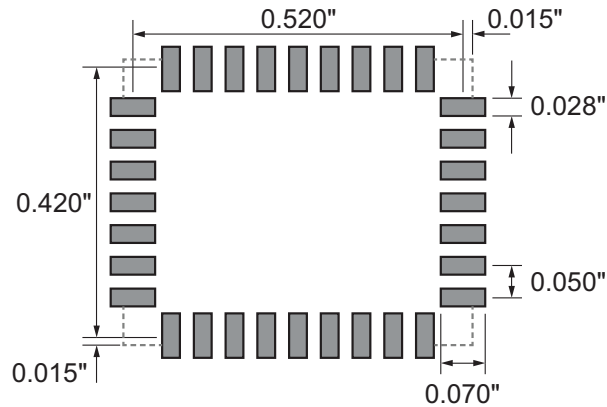

Figure 110: HUM-***-PRO Recommended PCB Layout

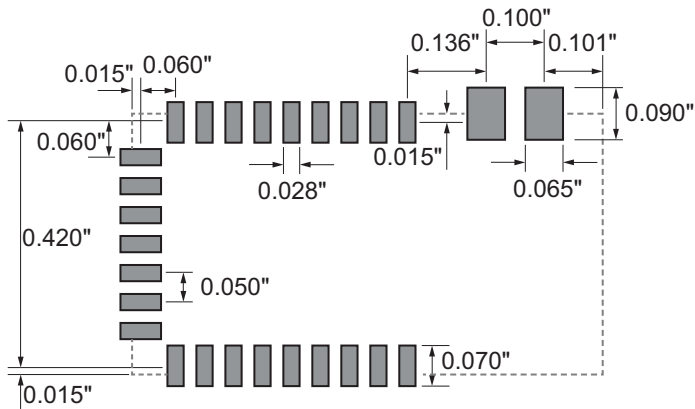

Figure 111: HUM-***-PRO-UFL/CAS Recommended PCB Layout

Microstrip Details

A transmission line is a medium whereby RF energy is transferred from one place to another with minimal loss. This is a critical factor, especially in high-frequency products like Linx RF modules, because the trace leading to the module's antenna can effectively contribute to the length of the antenna, changing its resonant bandwidth. In order to minimize loss and detuning, some form of transmission line between the antenna and the module should be used unless the antenna can be placed very close (<1/8in) to the module. One common form of transmission line is a coax cable and another is the microstrip. This term refers to a PCB trace running over a ground plane that is designed to serve as a transmission line between the module and the antenna. The width is based on the desired characteristic impedance of the line, the thickness of the PCB and the dielectric constant of the board material. For standard 0.062in thick FR-4 board material, the trace width would be 111 mils. The correct trace width can be calculated for other widths and materials using the information in Figure 112 and examples are provided in Figure 113. Software for calculating microstrip lines is also available on the Linx website.

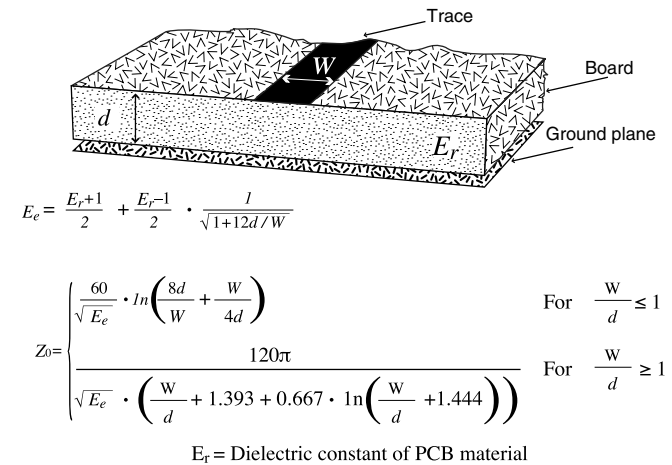

Figure 112: Microstrip Formulas

Example Microstrip Calculations

Dielectric Constant	Width / Height Ratio (W / d)	Effective Dielectric Constant	Characteristic Impedance (Ω)
4.80	1.8	3.59	50.0
4.00	2.0	3.07	51.0
2.55	3.0	2.12	48.8

Figure 113: Example Microstrip Calculations

Board Layout Guidelines

The module's design makes integration straightforward; however, it is still critical to exercise care in PCB layout. Failure to observe good layout techniques can result in a significant degradation of the module's performance. A primary layout goal is to maintain a characteristic 50-ohm impedance throughout the path from the antenna to the module. Grounding, filtering, decoupling, routing and PCB stack-up are also important considerations for any RF design. The following section provides some basic design guidelines.

During prototyping, the module should be soldered to a properly laid-out circuit board. The use of prototyping or "perf" boards results in poor performance and is strongly discouraged. Likewise, the use of sockets can have a negative impact on the performance of the module and is discouraged.

The module should, as much as reasonably possible, be isolated from other components on your PCB, especially high-frequency circuitry such as crystal oscillators, switching power supplies, and high-speed bus lines.

When possible, separate RF and digital circuits into different PCB regions.

Make sure internal wiring is routed away from the module and antenna and is secured to prevent displacement.

Do not route PCB traces directly under the module. There should not be any copper or traces under the module on the same layer as the module, just bare PCB. The underside of the module has traces and vias that could short or couple to traces on the product's circuit board.

The Pad Layout section shows a typical PCB footprint for the module. A ground plane (as large and uninterrupted as possible) should be placed on a lower layer of your PC board opposite the module. This plane is essential for creating a low impedance return for ground and consistent stripline performance.

Use care in routing the RF trace between the module and the antenna or connector. Keep the trace as short as possible. Do not pass it under the module or any other component. Do not route the antenna trace on multiple PCB layers as vias add inductance. Vias are acceptable for tying together ground layers and component grounds and should be used in multiples.

Each of the module's ground pins should have short traces tying immediately to the ground plane through a via.

Bypass caps should be low ESR ceramic types and located directly adjacent to the pin they are serving.

A 50-ohm coax should be used for connection to an external antenna. A 50-ohm transmission line, such as a microstrip, stripline or coplanar waveguide should be used for routing RF on the PCB. The Microstrip Details section provides additional information.

In some instances, a designer may wish to encapsulate or "pot" the product. There are a wide variety of potting compounds with varying dielectric properties. Since such compounds can considerably impact RF performance and the ability to rework or service the product, it is the responsibility of the designer to evaluate and qualify the impact and suitability of such materials.

Helpful Application Notes from Linx

It is not the intention of this manual to address in depth many of the issues that should be considered to ensure that the modules function correctly and deliver the maximum possible performance. We recommend reading the application notes listed in Figure 114 which address in depth key areas of RF design and application of Linx products. These applications notes are available online at www.linxtechnologies.com or by contacting the Linx literature department.

Helpful Application Note Titles	
Note Number	Note Title
AN-00100	RF 101: Information for the RF Challenged
AN-00126	Considerations for Operation Within the 902–928MHz Band
AN-00130	Modulation Techniques for Low-Cost RF Data Links
AN-00140	The FCC Road: Part 15 from Concept to Approval
AN-00500	Antennas: Design, Application, Performance
AN-00501	Understanding Antenna Specifications and Operation

Figure 114: Helpful Application Note Titles

Production Guidelines

The module is housed in a hybrid SMD package that supports hand and automated assembly techniques. Since the modules contain discrete components internally, the assembly procedures are critical to ensuring the reliable function of the modules. The following procedures should be reviewed with and practiced by all assembly personnel.

Hand Assembly

Pads located on the bottom of the module are the primary mounting surface (Figure 115). Since these pads are inaccessible during mounting, castellations that run up the side of the module have been provided to facilitate solder wicking to the module's underside. This allows for very

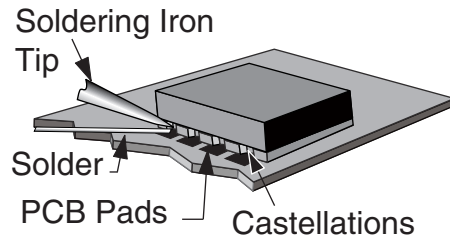

Figure 115: Soldering Technique

quick hand soldering for prototyping and small volume production. If the recommended pad guidelines have been followed, the pads will protrude slightly past the edge of the module. Use a fine soldering tip to heat the board pad and the castellation, then introduce solder to the pad at the module's edge. The solder will wick underneath the module, providing reliable attachment. Tack one module corner first and then work around the device, taking care not to exceed the times in Figure 116.

Warning: Pay attention to the absolute maximum solder times.

Absolute Maximum Solder Times

Hand Solder Temperature: +427°C for 10 seconds for lead-free alloys

Reflow Oven: +255°C max (see Figure 117)

Figure 116: Absolute Maximum Solder Times

Automated Assembly

For high-volume assembly, the modules are generally auto-placed. The modules have been designed to maintain compatibility with reflow processing techniques; however, due to their hybrid nature, certain aspects of the assembly process are far more critical than for other component types. Following are brief discussions of the three primary areas where caution must be observed.

Reflow Temperature Profile

The single most critical stage in the automated assembly process is the reflow stage. The reflow profile in Figure 117 should not be exceeded because excessive temperatures or transport times during reflow will irreparably damage the modules. Assembly personnel need to pay careful attention to the oven's profile to ensure that it meets the requirements necessary to successfully reflow all components while still remaining within the limits mandated by the modules. The figure below shows the recommended reflow oven profile for the modules.

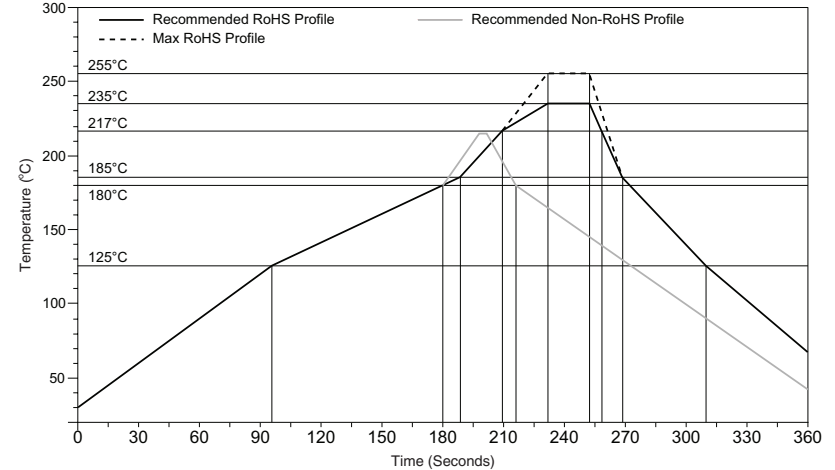

Figure 117: Maximum Reflow Temperature Profile

Shock During Reflow Transport

Since some internal module components may reflow along with the components placed on the board being assembled, it is imperative that the modules not be subjected to shock or vibration during the time solder is liquid. Should a shock be applied, some internal components could be lifted from their pads, causing the module to not function properly.

Washability

The modules are wash-resistant, but are not hermetically sealed. Linx recommends wash-free manufacturing; however, the modules can be subjected to a wash cycle provided that a drying time is allowed prior to applying electrical power to the modules. The drying time should be sufficient to allow any moisture that may have migrated into the module to evaporate, thus eliminating the potential for shorting damage during power-up or testing. If the wash contains contaminants, the performance may be adversely affected, even after drying.

General Antenna Rules

The following general rules should help in maximizing antenna performance.

1. Proximity to objects such as a user's hand, body or metal objects will cause an antenna to detune. For this reason, the antenna shaft and tip should be positioned as far away from such objects as possible.
2. Optimum performance is obtained from a $\frac{1}{4}$ - or $\frac{1}{2}$ -wave straight whip mounted at a right angle to the ground plane (Figure 118). In many cases, this isn't desirable for practical or ergonomic reasons, thus, an alternative antenna style such as a helical, loop or patch may be utilized and the corresponding sacrifice in performance accepted.

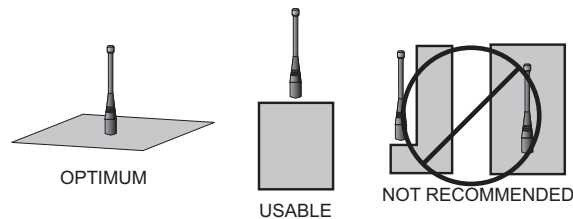

Figure 118: Ground Plane Orientation

3. If an internal antenna is to be used, keep it away from other metal components, particularly large items like transformers, batteries, PCB tracks and ground planes. In many cases, the space around the antenna is as important as the antenna itself. Objects in close proximity to the antenna can cause direct detuning, while those farther away will alter the antenna's symmetry.
4. In many antenna designs, particularly $\frac{1}{4}$ -wave whips, the ground plane acts as a counterpoise, forming, in essence, a $\frac{1}{2}$ -wave dipole (Figure 119). For this reason, adequate ground plane area is essential. The ground plane can be a metal case or ground-fill areas on a circuit board. Ideally, it should have a surface area less than or equal to the overall length of the $\frac{1}{4}$ -wave radiating element. This is often not practical due to size and configuration constraints. In these instances, a designer must make the best use of the area available to create as much ground

VERTICAL $\lambda/4$ GROUNDED ANTENNA (MARCONI)

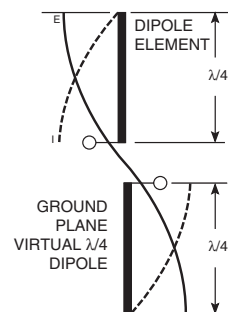

Figure 119: Dipole Antenna

plane as possible in proximity to the base of the antenna. In cases where the antenna is remotely located or the antenna is not in close proximity to a circuit board, ground plane or grounded metal case, a metal plate may be used to maximize the antenna's performance.

5. Remove the antenna as far as possible from potential interference sources. Any frequency of sufficient amplitude to enter the receiver's front end will reduce system range and can even prevent reception entirely. Switching power supplies, oscillators or even relays can also be significant sources of potential interference. The single best weapon against such problems is attention to placement and layout. Filter the module's power supply with a high-frequency bypass capacitor. Place adequate ground plane under potential sources of noise to shunt noise to ground and prevent it from coupling to the RF stage. Shield noisy board areas whenever practical.
6. In some applications, it is advantageous to place the module and antenna away from the main equipment (Figure 120). This can avoid interference problems and allows the antenna to be oriented for optimum performance. Always use 50Ω coax, like RG-174, for the remote feed.

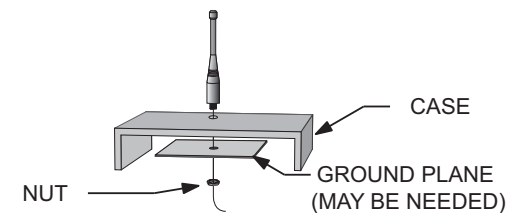

Figure 120: Remote Ground Plane

Common Antenna Styles

There are hundreds of antenna styles and variations that can be employed with Linx RF modules. Following is a brief discussion of the styles most commonly utilized. Additional antenna information can be found in Linx Application Notes AN-00100, AN-00140, AN-00500 and AN-00501. Linx antennas and connectors offer outstanding performance at a low price.

Whip Style

A whip style antenna (Figure 121) provides outstanding overall performance and stability. A low-cost whip can be easily fabricated from a wire or rod, but most designers opt for the consistent performance and cosmetic appeal of a professionally-made model. To meet this need, Linx offers a wide variety of straight and reduced height whip style antennas in permanent and connectorized mounting styles.



Figure 121: Whip Style Antennas

The wavelength of the operational frequency determines an antenna's overall length. Since a full wavelength is often quite long, a partial 1/2- or 1/4-wave antenna is normally employed. Its size and natural radiation resistance make it well matched to Linx modules. The proper length for a straight 1/4-wave can be easily determined using the formula in Figure 122. It is also possible to reduce the overall height of the antenna by using a helical winding. This reduces the antenna's bandwidth but is a great way to minimize the antenna's physical size for compact applications. This also means that the physical appearance is not always an indicator of the antenna's frequency.

$$L = \frac{234}{F_{\text{MHz}}}$$

Figure 122:
L = length in feet of quarter-wave length
F = operating frequency in megahertz

Specialty Styles

Linx offers a wide variety of specialized antenna styles (Figure 123). Many of these styles utilize helical elements to reduce the overall antenna size while maintaining reasonable performance. A helical antenna's bandwidth is often quite narrow and the antenna can detune in proximity to other objects, so care must be exercised in layout and placement.



Figure 123: Specialty Style Antennas

Loop Style

A loop or trace style antenna is normally printed directly on a product's PCB (Figure 124). This makes it the most cost-effective of antenna styles. The element can be made self-resonant or externally resonated with discrete components, but its actual layout is usually product specific. Despite the cost advantages, loop style antennas are generally inefficient and useful only for short range applications. They are also very sensitive to changes in layout and PCB dielectric, which can cause consistency issues during production. In addition, printed styles are difficult to engineer, requiring the use of expensive equipment including a network analyzer. An improperly designed loop will have a high VSWR at the desired frequency which can cause instability in the RF stage.



Figure 124: Loop or Trace Antenna

Linx offers low-cost planar (Figure 125) and chip antennas that mount directly to a product's PCB. These tiny antennas do not require testing and provide excellent performance despite their small size. They offer a preferable alternative to the often problematic "printed" antenna.



Figure 125: SP Series "Splatch" and uSP "MicroSplatch" Antennas

Regulatory Considerations

Note: Linx RF modules are designed as component devices that require external components to function. The purchaser understands that additional approvals may be required prior to the sale or operation of the device, and agrees to utilize the component in keeping with all laws governing its use in the country of operation.

When working with RF, a clear distinction must be made between what is technically possible and what is legally acceptable in the country where operation is intended. Many manufacturers have avoided incorporating RF into their products as a result of uncertainty and even fear of the approval and certification process. Here at Linx, our desire is not only to expedite the design process, but also to assist you in achieving a clear idea of what is involved in obtaining the necessary approvals to legally market a completed product.

For information about regulatory approval, read AN-00142 on the Linx website or call Linx. Linx designs products with worldwide regulatory approval in mind.

In the United States, the approval process is actually quite straightforward. The regulations governing RF devices and the enforcement of them are the responsibility of the Federal Communications Commission (FCC). The regulations are contained in Title 47 of the United States Code of Federal Regulations (CFR). Title 47 is made up of numerous volumes; however, all regulations applicable to this module are contained in Volume 0-19. It is strongly recommended that a copy be obtained from the FCC's website, the Government Printing Office in Washington or from your local government bookstore. Excerpts of applicable sections are included with Linx evaluation kits or may be obtained from the Linx Technologies website, www.linxtechnologies.com. In brief, these rules require that any device that intentionally radiates RF energy be approved, that is, tested for compliance and issued a unique identification number. This is a relatively painless process. Final compliance testing is performed by one of the many independent testing laboratories across the country. Many labs can also provide other certifications that the product may require at the same time, such as UL, CLASS A / B, etc. Once the completed product has passed, an ID number is issued that is to be clearly placed on each product manufactured.

Questions regarding interpretations of the Part 2 and Part 15 rules or the measurement procedures used to test intentional radiators such as Linx RF modules for compliance with the technical standards of Part 15 should be addressed to:

Federal Communications Commission
Equipment Authorization Division
Customer Service Branch, MS 1300F2
7435 Oakland Mills Road
Columbia, MD, US 21046
Phone: + 1 301 725 585 | Fax: + 1 301 344 2050
Email: labinfo@fcc.gov

ETSI Secretaria
650, Route des Lucioles
06921 Sophia-Antipolis Cedex
FRANCE
Phone: +33 (0)4 92 94 42 00
Fax: +33 (0)4 93 65 47 16

International approvals are slightly more complex, although Linx modules are designed to allow all international standards to be met. If the end product is to be exported to other countries, contact Linx to determine the specific suitability of the module to the application.

All Linx modules are designed with the approval process in mind and thus much of the frustration that is typically experienced with a discrete design is eliminated. Approval is still dependent on many factors, such as the choice of antennas, correct use of the frequency selected and physical packaging. While some extra cost and design effort are required to address these issues, the additional usefulness and profitability added to a product by RF makes the effort more than worthwhile.

TE TECHNICAL SUPPORT CENTER

USA:	+1 (800) 522-6752
Canada:	+1 (905) 475-6222
Mexico:	+52 (0) 55-1106-0800
Latin/S. America:	+54 (0) 11-4733-2200
Germany:	+49 (0) 6251-133-1999
UK:	+44 (0) 800-267666
France:	+33 (0) 1-3420-8686
Netherlands:	+31 (0) 73-6246-999
China:	+86 (0) 400-820-6015

te.com

TE Connectivity, TE, TE connectivity (logo), Linx and Linx Technologies are trademarks owned or licensed by the TE Connectivity Ltd. family of companies. All other logos, products and/or company names referred to herein might be trademarks of their respective owners.

The information given herein, including drawings, illustrations and schematics which are intended for illustration purposes only, is believed to be reliable. However, TE Connectivity makes no warranties as to its accuracy or completeness and disclaims any liability in connection with its use. TE Connectivity's obligations shall only be as set forth in TE Connectivity's Standard Terms and Conditions of Sale for this product and in no case will TE Connectivity be liable for any incidental, indirect or consequential damages arising out of the sale, resale, use or misuse of the product. Users of TE Connectivity products should make their own evaluation to determine the suitability of each such product for the specific application.

TE Connectivity warrants to the original end user customer of its products that its products are free from defects in material and workmanship. Subject to conditions and limitations TE Connectivity will, at its option, either repair or replace any part of its products that prove defective because of improper workmanship or materials. This limited warranty is in force for the useful lifetime of the original end product into which the TE Connectivity product is installed. Useful lifetime of the original end product may vary but is not warranted to exceed one (1) year from the original date of the end product purchase.

©2023 TE Connectivity. All Rights Reserved.

06/23 Original
