

HTU20P(F) RH/T SENSOR IC

Miniature Relative Humidity and Temperature

- DFN type package
- Relative Humidity and Temperature Analog Output, PWM interface
- Fully calibrated
- Lead free sensor, reflow solderable
- Low power consumption
- Fast response time

HTU20P(F) is a new humidity and temperature sensor by MEAS. Setting new standards in terms of size and intelligence, it is embedded in a reflow solderable Dual Flat No leads (DFN) package of 3 x 3 x 0.9 mm foot print. This sensor provides calibrated, linearized signals in analog pulse width modulated (PWM) format.

HTU20P(F) humidity sensors are dedicated humidity and temperature plug and play transducers for OEM applications where reliable and accurate measurements are needed. These low power sensors are designed for high volume and cost sensitive applications with tight space constraints.

PWM signal runs on a base frequency of 120Hz, the data signal is provided on SDA line. Pulling SCL high or low allows for switching between humidity and temperature, respectively. The sensor measures twice per second. The PWM signal may be converted to an analog ratiometric interface by adding a low pass filter.

With MEAS' improvements and miniaturization of the sensor, the performance-to-price ratio has been improved – and eventually, any device should benefit from the cutting-edge energy saving operation mode. HTU20 is also available with digital I²C (HTU20D(F)).

Optional PTFE filter/membrane (F) protects HTU20P analog humidity sensors against dust and water immersion, as well as against contamination by particles. PTFE filter/membrane preserves a high response time. The white PTFE filter/membrane is directly stuck on the sensor housing. This membrane is allowing an IP67 compliant protection.

FEATURES

- Full interchangeability with no calibration required in standard conditions
- Instantaneous desaturation after long periods in saturation phase
- Compatible with automatized assembly processes, including Pb free and reflow processes
- Individual marking for compliance to stringent traceability requirements

APPLICATIONS

- Home Appliance
- Medical
- Printers
- Humidifier
- Multimedia: Smartphone, Tablet.

NOMENCLATURE

HTU2XY(F)

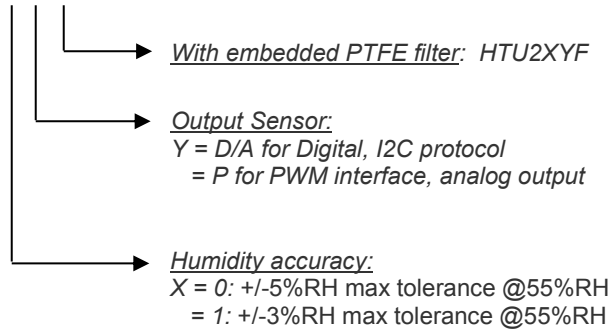

HTU2XY Modules



HTU2XYF Modules

PERFORMANCE SPECS

Maximum Ratings

Ratings	Symbol	Value	Unit
Storage Temperature	T _{stg}	-40 to 125	°C
Supply Voltage (Peak)	V _{cc}	3.8V	V _{dc}
Humidity Operating Range	RH	0 to 100	%RH
Temperature Operating Range	T _a	-40 to +125	°C
VDD to GND		-0.3 to 3.6	V _{dc}
Digital I/O pins (DATA/SCK) to VDD		-0.3 to VDD+0.3	V _{dc}
Input current on any pin		-10 to +10	mA

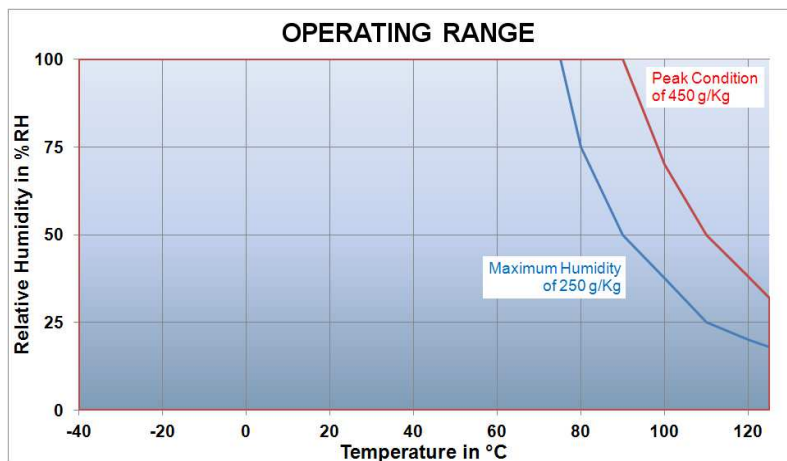

Graph above show peak conditions: less than 10% of the operating time

Exposure to absolute maximum rating conditions for extended periods may affect the sensor reliability.

HTU20P(F) RH/T SENSOR IC

Miniature Relative Humidity and Temperature

ELECTRICAL AND GENERAL ITEMS

(@T = 25°C, @Vdd = 3V)

Characteristics	Symbol	Min	Typ	Max	Unit
Voltage Supply	VDD	1.5	3.0	3.6	V _{dc}
Current consumption	idd		5	14	μA
Power Dissipation			15	50	μW
Communication	Analog output, PWM interface				
PWM Frequency ⁽¹⁾		108	120	132	Hz
Temperature drift of PWM frequency		-0.07		-0.12	Hz/°C
Measurement Frequency			2		Hz
Switch RH/T on DATA	SCK up → RH, SCK down → T				
Storage	-40°C/125°C				

(1) Conditions: Temp=40°C

SENSOR PERFORMANCE

Relative Humidity

(@T = 25°C, @Vdd = 3V)

Characteristics	Symbol	Min	Typ	Max	Unit
Resolution	10 bit		0.04		%RH
Humidity Operating Range	RH	0		100	%RH
Relative Humidity Accuracy @25°C (10%RH to 95%RH)	typ		±3		%RH
	max			See graph1	%RH
Replacement	fully interchangeable				
Temperature coefficient (from 0°C to 80°C)	T _{cc}			-0.15	%RH/°C
Humidity Hysteresis			±1		%RH
Recovery time after 150 hours of condensation	t		10		s
Long term drift			0.5		%RH/yr
Response Time (at 63% of signal) from 33% to 75%RH ⁽²⁾	T _{RH}		5	10	s

⁽¹⁾ Typical values are recommended for calculating energy consumption while maximum values shall be applied for calculating waiting times in communication.

⁽²⁾ At 1m/s air flow

GRAPH 1: RELATIVE HUMIDITY ERROR BUDGET CONDITIONS AT 25°C

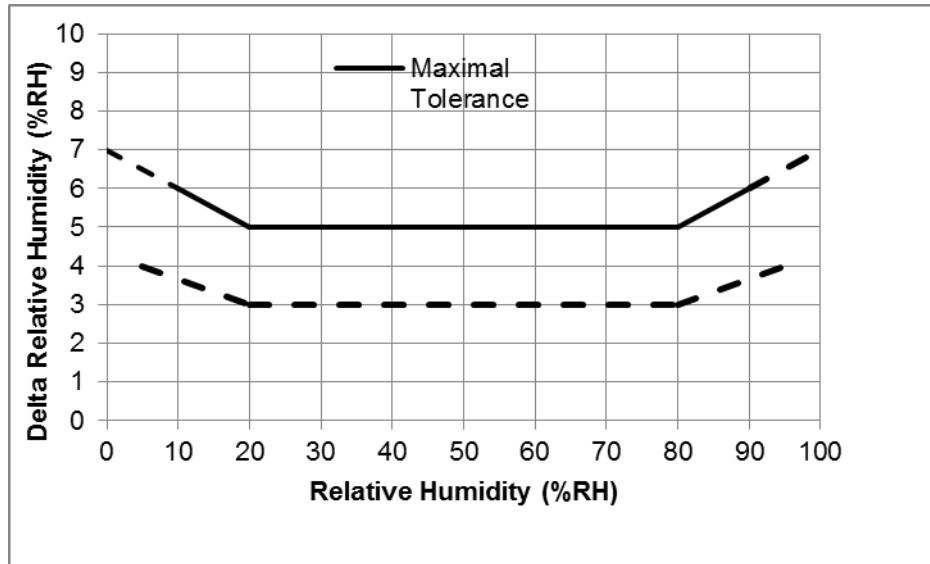

- HTU20P(F) sensors are specified for optimum accuracy measurements within 5 to 95%RH.
- Operation out of this range (< 5% or > 95% RH, including condensation) is however possible.

TEMPERATURE COEFFICIENT COMPENSATION EQUATION

Using the following temperature coefficient compensation equation will guarantee Relative Humidity accuracy given p.3, from 0°C to 80°C.

$$RH_{compensatedT} = RH_{actualT} + (25 - T_{actual}) \times CoeffTemp$$

- RHactualT Ambient humidity in %RH, computed from HTU20P(F) sensor
- Tactual Humidity cell temperature in °C, computed from HTU20P(F) sensor
- CoeffTemp Temperature coefficient of the HTU20P(F) in %RH/°

TEMPERATURE

Characteristics		Symbol	Min	Typ	Max	Unit
Resolution	12 bit			0.01		°C
Temperature Operating Range		T	-40		+125	°C
Temperature Accuracy @25°C	typ			±0.3		°C
	max			See graph2		°C
Replacement			fully interchangeable			
Long term drift				0.04		°C/yr
Response Time (at 63% of signal) from 15°C to 45°C ⁽²⁾		T _T		10		s

⁽¹⁾ Typical values are recommended for calculating energy consumption while maximum values shall be applied for calculating waiting times in communication.

HTU20P(F) RH/T SENSOR IC

Miniature Relative Humidity and Temperature

(2) At 1m/s air flow

GRAPH 2: TEMPERATURE ERROR BUDGET

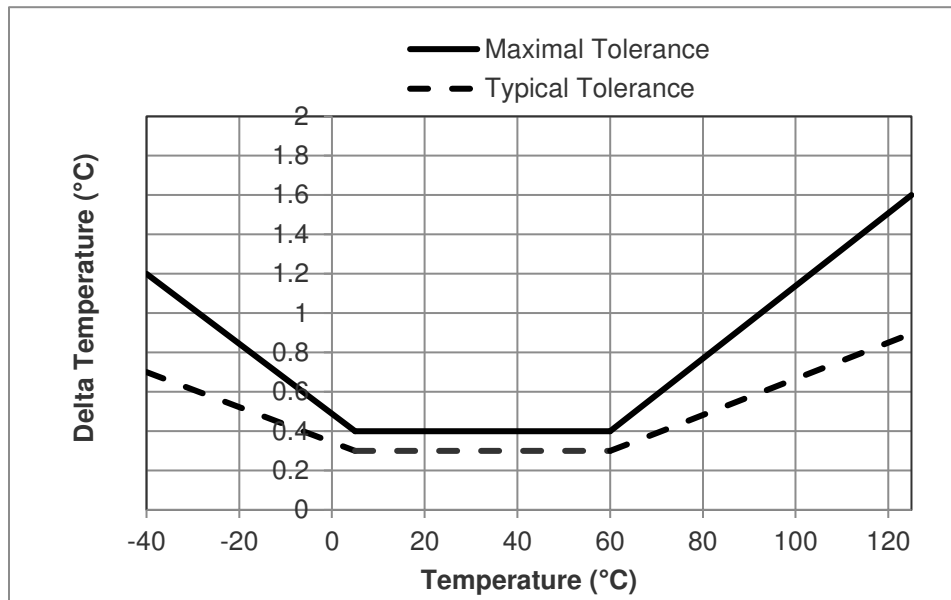

USER GUIDE HTU20P(F)

APPLICATION INFORMATION

- **Soldering instructions: Lead free reflow soldering recommended process**

For soldering HTU20P (F) sensor standard reflow soldering ovens may be used.

HTU20P(F) sensor as a humidity sensitive component (as classified by IPC/JEDEC J-STD-020 or equivalent documented procedure with peak temperature at 260°C during up to 30 seconds for Pb-free assembly in IR/convection reflow ovens) must be handled in a manner consistent with IPC/JEDEC J-STD-033 or an equivalent documented procedure. IPC-1601 provides humidity control, handling and packing of PCBs.

The HTU20P(F) sensor is qualified to withstand one lead free reflow soldering recommended process profile below according to JEDEC standard.

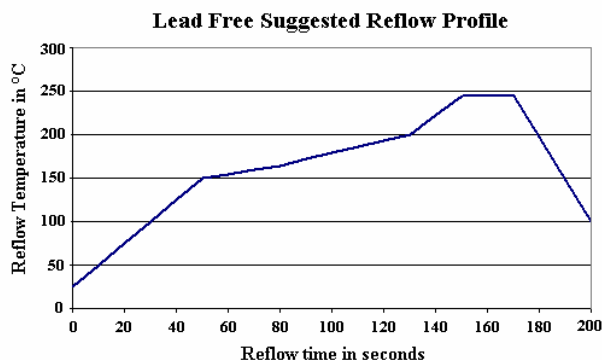

HTU20P(F) RH/T SENSOR IC

Miniature Relative Humidity and Temperature

Mount parts within 24 hours after printing solder paste to avoid potential dry up.

For manual soldering, contact time must be limited to 5 seconds at up to 350°C.

For the design of the HTU20P(F) sensor footprint, it is recommended to use dimensions according to figure below.

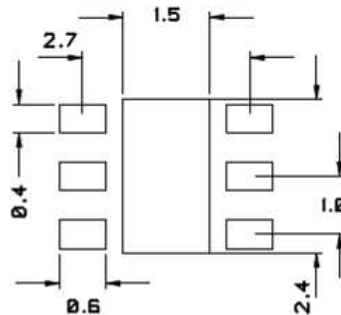

Recommended footprint for HTU20P(F) sensors. Values in mm.

No specific conditioning of devices is necessary after soldering process, either manual or reflow soldering. Optimized performance in case of metrological measurements can be reached with stabilization of devices (24 hours at 25°C / 55%RH). Similar process is advised after exposure of the devices to extreme relative humidity conditions.

- **Storage Conditions and Handling Instructions**

It is recommended to store HTU20P(F) sensor in its original packaging at following conditions: Temperature shall be in the range of -40°C – 125°C.

- **Temperature Effects**

Relative humidity reading strongly depends on temperature. Therefore, it is essential to keep humidity sensors at the same temperature as the air of which the relative humidity is to be measured.

In case of testing or qualification the reference sensor and test sensor must show equal temperature to allow for comparing humidity readings.

The HTU20P(F) sensor should be mounted in a way that prevents heat transfer from electronic sensor or that keeps it as low as possible. Advice can be ventilation, reduction of copper layers between the HTU20P(F) sensor and the rest of the PCB or milling a slit into the PCB around the sensor (1mm minimum width).

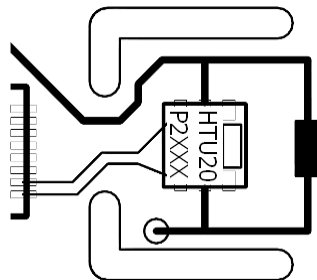

Example of HTU20P(F) sensor mounting with slits/mills to minimize heat transfer

- **Materials Used for Sealing / Mounting**

For sealing and gluing (use sparingly), use high filled epoxy for electronic packaging and silicone. For any specific material please request to pic.info@te.com.

- **Wiring Considerations and Signal Integrity**

Power supply pins (VDD, GND) must be decoupled with a 100nF capacitor. Capacitor should be placed as close as possible to the sensor.

HTU20P(F) RH/T SENSOR IC

Miniature Relative Humidity and Temperature

- **ESD (ElectroStatic Discharge)**

ESD immunity is qualified according to:

- JEDEC JESD22-A114 method (Human Body Model at $\pm 4\text{kV}$) for pads & open window
- JEDEC JESD22-A115 method (Machine Model $\pm 200\text{V}$)
- ESDA ESD-STM5.3.1-1999 and AEC-Q100-011 (charged device model, 750V corner pins, 500V other pins)

Latch-up immunity is provided at a force current of $\pm 100\text{mA}$ with $T_{\text{amb}}=25^\circ\text{C}$ according to JEDEC JESD78. For exposure beyond named limits the sensor need additional protection circuit.

INTERFACE SPECIFICATION

N°	Function	Comment
1	DATA	Data bit-stream
2	GND	Ground
3	NC	Must be left unconnected
4	NC	Must be left unconnected
5	VDD	Supply Voltage
6	SCK	Selector for RH or T
PAD		Ground or unconnected

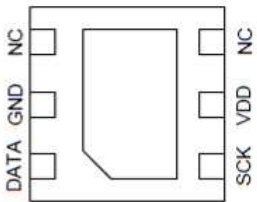
- **Power Pins (VDD, GND)**

The supply voltage of HTU20P(F) sensors must be in the range of 1.5VDC - 3.6VDC. Recommended supply voltage is 3VDC (regulated).

However, the typical application circuit includes a 100nF decoupling capacitor between VDD and GND, placed as close as possible to the sensor.

- **Output Selector Pad (SCK)**

SCK is used to select relative humidity or temperature output. SCK high yields humidity output, SCK low yields temperature. Please note that a change of SCK will affect the output on DATA after maximum 1.2 seconds.

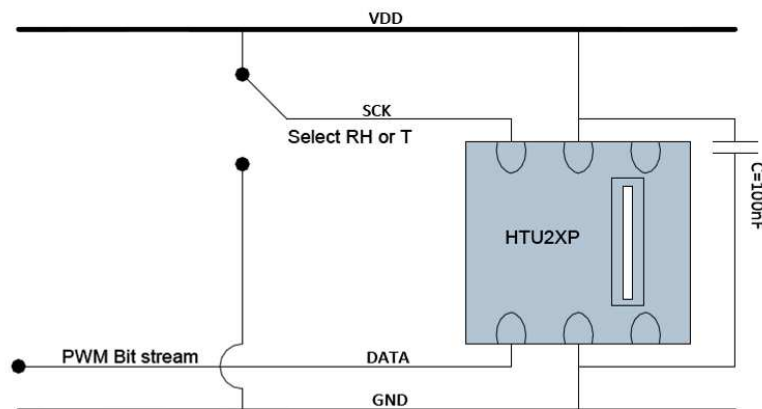

Typical application circuit, including decoupling of VDD and GND by a capacitor.

HTU20P(F) RH/T SENSOR IC

Miniature Relative Humidity and Temperature

Bit Stream Pad (DATA)

On DATA line, the HTU20P(F) sensor is providing PWM output. The signal is carrying relative humidity or temperature data depending on SCK being high or low, respectively. See Table next page for detailed I/O characteristic of the HTU20P(F) sensor.

ELECTRICAL CHARACTERISTICS

- **Input/output DC characteristics**

(VDD=1.5V to 3.6V, Temperature=-40°C to 125°C unless otherwise noted)

Characteristics	Symbol	Min	Typ	Max	Unit
Output Low Voltage	VOL	0		30%VDD	V
Output High Voltage	VOH	70%VDD		VDD	V

COMMUNICATION WITH HTU20P(F) SENSOR

- **Start-up sensor**

As a first step, the HTU20P(F) sensor is powered up to VDD (between 1.5V and 3.6V). Then the HTU20P(F) sensor starts measuring and providing data on PWM bit-stream.

- **PWM Specification**

Pulse Width Modulation (PWM) runs on a constant frequency and the measured information is provided as duty cycle on that frequency. Such information is measured humidity for SCK pulled high and temperature for SCK pulled low.

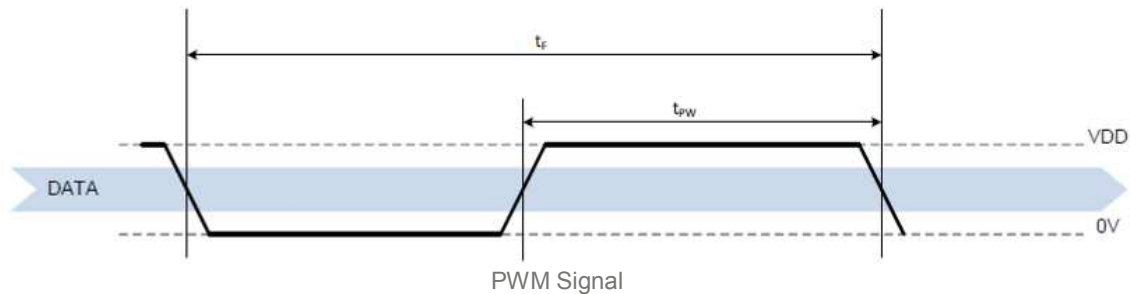

Base frequency runs constantly at approximately 120 Hz, hence t_F is about 8.3ms. The signal is provided on t_{PW} as a ratio of t_{PW} to t_F . The measured data – either relative humidity or temperature – is provided as ratio of t_{PW} and t_F . t_{PW} shall always be given as ratio of t_F to make it independent of variations of the base frequency.

CONVERSION OF SIGNAL OUTPUTS

Resolution is set to 10-bit relative humidity and 12 bit temperature reading and cannot be changed. The sensor reading is linear and hence it can be converted to a physical value by an easy linear equation.

To accommodate/adapt any process variation (nominal capacitance value of the humidity die), tolerances of the sensor above 100%RH and below 0%RH must be considered. As a consequence:

- RH output can reach 118%RH and above this value, there will have a clamp of the RH output to this value.
- RH output can reach -6%RH and below this value, there will have a clamp of the RH output to this value.

Relative Humidity conversion

With the relative humidity signal output SRH, the relative humidity is obtained using the following formula (result in %RH), no matter which resolution is chosen:

$$RH = -6 + 125 \times \frac{t_{PW}}{t_F}$$

- **Temperature conversion**

The temperature T is calculated by inserting the ratio of t_{PW} ad t_F into the following formula (result in °C), no matter which resolution is chosen:

$$Temp = -46.85 + 175.72 \times \frac{t_{PW}}{t_F}$$

APPLICATION: DEW POINT TEMPERATURE MEASUREMENT

The dew point is the temperature at which the water vapor in the air becomes saturated and condensation begins.

The dew point is associated with relative humidity. A high relative humidity indicates that the dew point is closer to the current air temperature. Relative humidity of 100% indicates that the dew point is equal to the current temperature (and the air is maximally saturated with water). When the dew point stays constant and temperature increases, relative humidity will decrease.

Dew point temperature of the air is calculated using Ambient Relative Humidity and Temperature measurements from HTU20P(F) sensor with following formulas given below:

Partial Pressure ($PP_{T_{amb}}$) formula from Ambient Temperature:

$$PP_{T_{amb}} = 10^{\left[A - \frac{B}{(T_{amb} + C)} \right]}$$

Dew point Temperature (T_d) formula from Partial Pressure ($PP_{T_{amb}}$):

$$T_d = - \left[\frac{B}{\log_{10} \left(RH_{amb} \times \frac{PP_{T_{amb}}}{100} \right) - A} + C \right]$$

$PP_{T_{amb}}$	Partial Pressure in mmHg at ambient temperature (T_{amb})
RH_{amb}	Ambient humidity in %RH, computed from HTU20P(F) sensor
T_{amb}	Humidity cell temperature in °C, computed from HTU20P(F) sensor
T_d	Calculated Dew Point in °C
A, B, C	Constants: A=8.1332; B=1762.39; C=235.66

PACKAGE OUTLINE

- HTU20P Sensor Dimensions

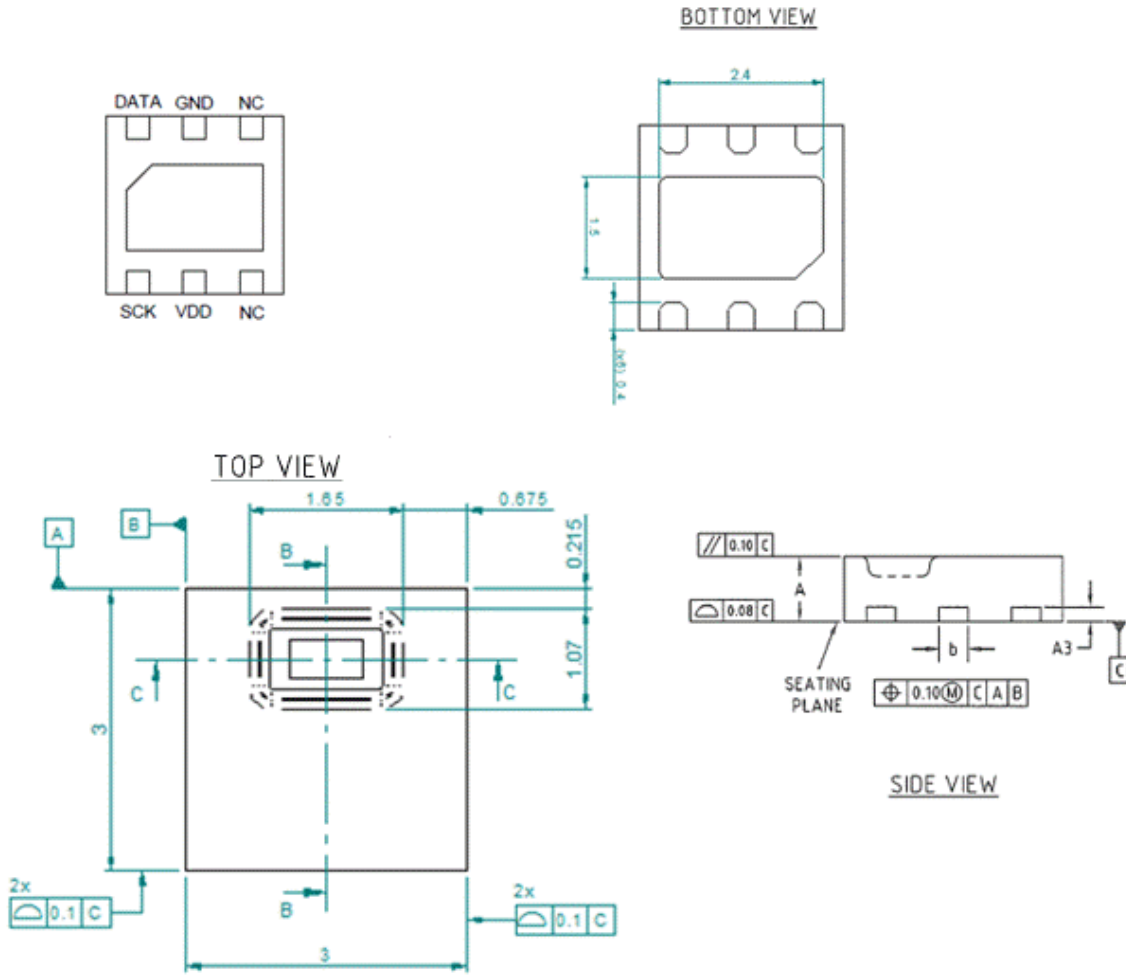

HTU20PF Sensor Dimensions

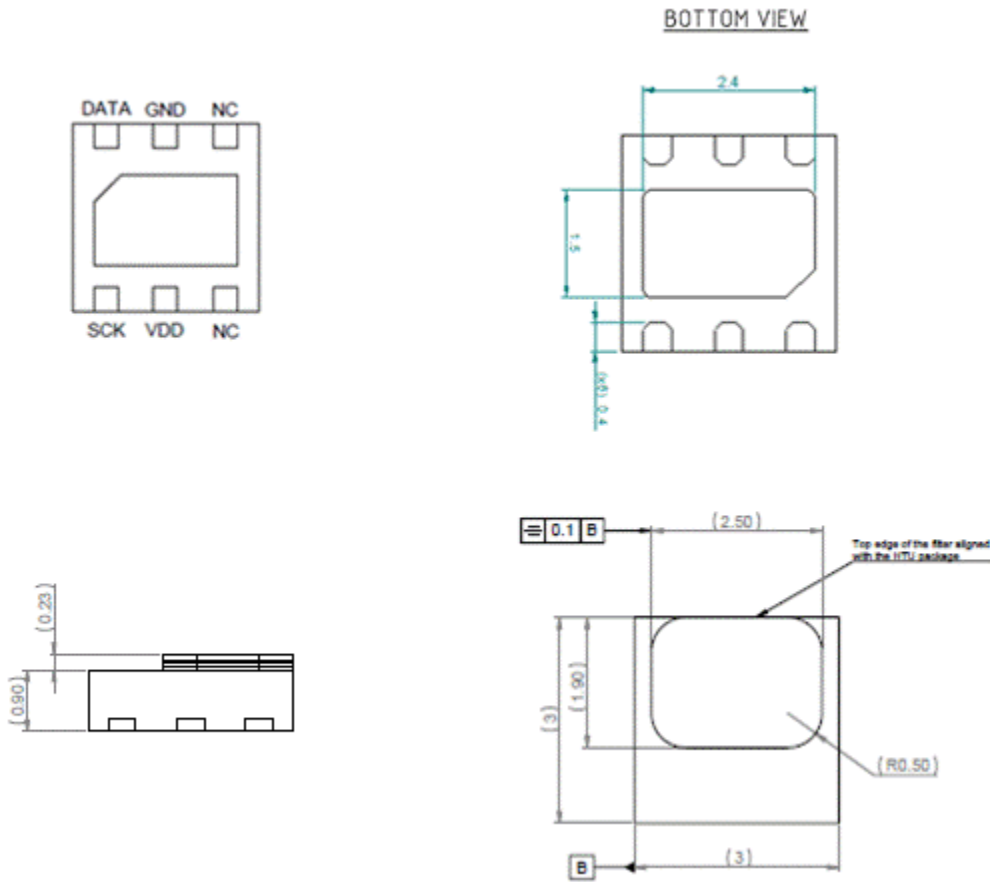

Dimensions are given in mm, tolerances are ± 0.1 mm. The die pad (thermal center pad) is internally connected to GND.

- **Packaging Type**

HTU20P(F) sensors are provided in DFN packaging. DFN stands for Dual Flat No leads.

The HTU20P(F) sensor chip is mounted to a lead frame made of Cu and plated with Ni/Pd/Au. Chip and lead frame are overmolded by green epoxy-based mold compound. Please note that side walls of sensors are diced and hence lead frame at diced edge is not covered with respective protective coating.

The total weight of the sensor is 0.025g.

- **Traceability Information**

All HTU20P(F) sensors are laser marked with an alphanumeric, five-digit code on the sensor as pictured below.

The marking on the HTU20P(F) sensor consists of two lines with five digits each: •

HTU20P(F) RH/T SENSOR IC

Miniature Relative Humidity and Temperature

- The first line denotes the sensor type: HTU20.
- The second line denotes several information as:
 - The first digit of the second line defines the output mode:
 - D or A = digital and I²C
 - D: ±2%RH typical / ±3%RH max from 20%RH to 80%RH
 - A: ±2%RH typical / ±3%RH max from 15%RH to 90%RH
 - P = PWM
 - The second digit defines the manufacturing year: 3 = 2013, 4 = 2014, etc.
 - The last three digits represent an alphanumeric tracking code. That code represents the day of the year.



Laser marking on HTU20P(F) sensor

Reels are also labeled, as displayed below and give additional traceability information.

Made in France



measurement
SPECIALTIES™

HPPxxxxxxx - IC 2X Humidity & Temperature

Lot No. : 2XY(F)-TTTTTTTTT



Quantity: QQQQ 

Datecode: YYDDD

✓RoHS



With:

2X:	Sensor Type (20 for HTU20P(F))
Y:	Output mode (D = Digital, P = PWM)
(F):	Sensor with PTFE membrane (only for HTU20PF)
TTTTTTTTT:	MEAS Traceability Code
YY:	Two last digits of the year
DDD:	Day of the year
QQQQ:	Quantity per reel (5000 units)

ORDERING INFORMATION

**** HTU20P – I.C 20P RH/T PWM ****

PACKAGE: TAPE AND REEL M.P.Q OF 5000 PIECES

- HPP845E035R5 - I.C 20P RH/T PWM in tape and reel of 5000 pieces**

**** HTU20PF – I.C 20PF RH/T PWM WITH PTFE MEMBRANE ****

PACKAGE: TAPE AND REEL M.P.Q OF 5000 PIECES

- HPP845E135R5 - I.C 20PF RH/T PWM in tape and reel of 5000 pieces**

Revision	Comments	Who	Date
0	Document Creation	D. LE GALL-ZIRILLI	August 13
1	General update	M.ROBERT	October 13
2	Obsolescence of HTU2XS (PDM interface) version Update of external package dimensions	M.ROBERT	January 14
3	Part number and designation modification	M.ROBERT	April 14
4	I/O characteristics table completion IP67 compliance, MSL2 classification, ESD recommandations	M.ROBERT	September 14
5	PN modification in "Ordering information" Header modification Symbol equation correction	T. RESTANCOURT	April 2018

NORTH AMERICA

Measurement Specialties, Inc.,
a TE Connectivity company
Tel: 800-522-6752 (option 2)
Email: customercare.ando@te.com

EUROPE

MEAS France SAS,
a TE Connectivity company
Tel: 800-440-5100
Email: customercare.tlse@te.com

ASIA

Measurement Specialties (China) Ltd.,
a TE Connectivity company
Tel: 0400-820-6015
Email: customercare.chdu@te.com

TE.com/sensorsolutions

Measurement Specialties, Inc., a TE Connectivity company.

TE Connectivity, TE, TE connectivity (logo) are trademarks. All other logos, products and/or company names referred to herein might be trademarks of their respective owners.

The information given herein, including drawings, illustrations and schematics which are intended for illustration purposes only, is believed to be reliable. However, TE Connectivity makes no warranties as to its accuracy or completeness and disclaims any liability in connection with its use. TE Connectivity's obligations shall only be as set forth in TE Connectivity's Standard Terms and Conditions of Sale for this product and in no case will TE Connectivity be liable for any incidental, indirect or consequential damages arising out of the sale, resale, use or misuse of the product. Users of TE Connectivity products should make their own evaluation to determine the suitability of each such product for the specific application.

© 2017 TE Connectivity Ltd. family of companies All Rights Reserved.

