

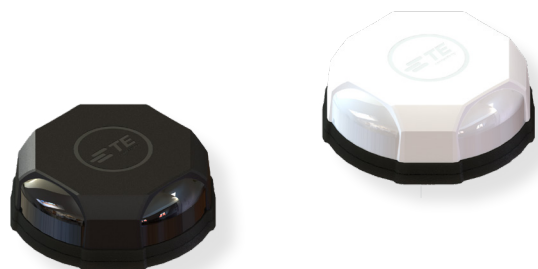

FP40 ULTRA 4X4 MIMO ANTENNAS

INTELLIGENT TRANSPORTATION

Datasheet & Kit Configurator Guide



FP40 ULTRA 4X4 MIMO VEHICULAR ANTENNAS

FP40 ultra antennas provide an all-in-one solution for LTE/5G, Wi-Fi, GNSS and Bluetooth in high bandwidth mobile connectivity applications.

The product family includes multi-port solutions up to 14-ports, along with a range of connector options to suit all major vehicular gateways and routers.

FEATURES AND BENEFITS

- Configurations available up to 14-ports incorporating next-generation technology
- 4G, 5G, CBRS, Wi-Fi, Bluetooth, GNSS coverage from a single antenna
- Designed for applications demanding the highest data rates and lowest latency
- Future-proofed against future 4G and 5G frequency rollouts up to 7125 MHz
- Compatible with all gateways & routers from major manufacturers
- Customizable connector, cable length and port configurations
- R118 compliant cables
- Stylish and aesthetical design

KEY DIFFERENTIATORS

- Low profile design, 66.5mm height, for improved vehicle clearance
- L1 and L5 GNSS for improved positioning accuracy and response times
- Out of band rejection filters maintain consistent performance
- High data throughput is enabled by technologies such as carrier aggregation
- Coverage of all 4G and 5G bands (617-7125 MHz), CBRS, Wi-Fi, Bluetooth and GNSS
- Superior gain patterns, low gain ripple, high gain at horizon and efficiency over 70%
- UV, flammability, humidity, impact, vibration, shock certified
- IP67 and IP69K rated for improved durability

TABLE OF CONTENTS

- [FP40 ultra kit overview](#)
- [FP40 ultra kit configurations](#)
- [FP40 ultra specifications](#)
- [FP40 ultra radiation patterns](#)
- [FP40 ultra packaging & drawings](#)
- [FP40 ultra example applications](#)

FP40 ULTRA 4X4 MIMO: ANTENNA OVERVIEW

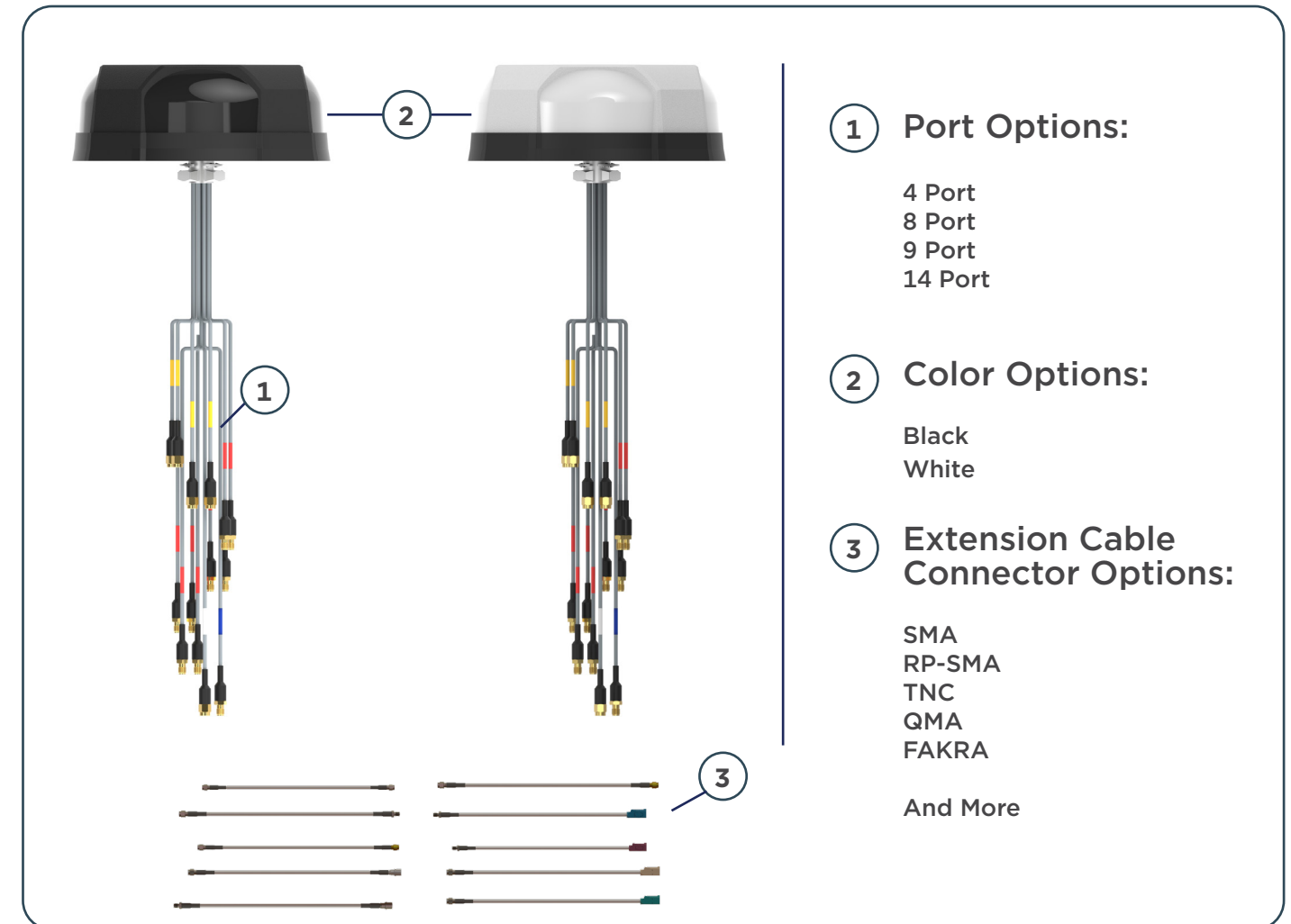

EXAMPLES OF CONNECTOR TERMINATIONS ON EXTENSION CABLES

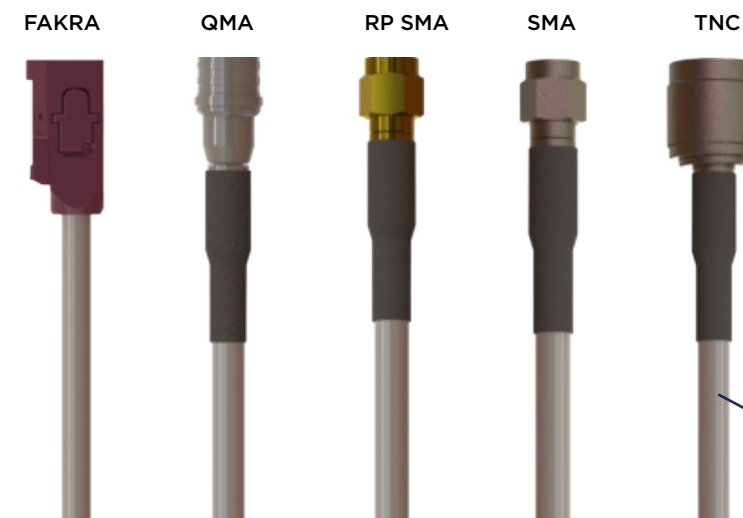

Extension Cables

All kits are supplied with a 5m extension cable set as standard (see pages 4-5 for standard extension cable connector options). Custom configurations are available on request.

Connectors will be individually marked with an appropriate label which is color coded to guide installers in connecting extension cables to the correct port on the router or gateway device.

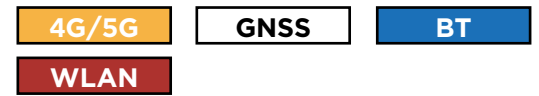

















FP40 ULTRA 4X4 MIMO: KIT CONFIGURATIONS

The table below shows common examples of the FP40 ultra kit configurations and the part numbers used to order these kits. Other options are available on request.

All kits are supplied with 5 meter (16 ft.) extension cables attached as standard. If you require different extension cable lengths or connector configurations please contact us to discuss your options.

FP40 ultra Kit	Port Configuration	Frequency (MHz)	Extension Cable Connector
4 Port - Kit Part No. - L000434-07			
 + 	4G/5G Port x 4	617-960; 1427-1511; 1690-2700; 3300-7125	SMA Male x 4
8 Port Option 1 - Kit Part No. - L000434-04			
 +    	4G/5G Port x 4	617-960; 1427-1511; 1690-2700; 3300-7125	SMA Male x 4
	WLAN Port x 2	2400-2500; 4900-7125	RP-SMA Male x 2
	GNSS Port x 1	1427-1511 (L1 & L5)	SMA Male x 1
	Bluetooth x 1	2400-2500	SMA Male x 1
8 Port Option 2 - Kit Part No. - L000434-05			
 +    	4G/5G Port x 4	617-960; 1427-1511; 1690-2700; 3300-7125	FAKRA D x 4
	WLAN Port x 2	2400-2500; 4900-7125	FAKRA I x 2
	GNSS Port x 1	1427-1511 (L1 & L5)	FAKRA C x 1
	Bluetooth x 1	2400-2500	FAKRA Z x 1
8 Port Option 3 - Kit Part No. - L000434-06			
 +    	4G/5G Port x 4	617-960; 1427-1511; 1690-2700; 3300-7125	SMA Male x 4
	WLAN Port x 2	2400-2500; 4900-7125	RP-SMA Male x 2
	GNSS Port x 1	1427-1511 (L1 & L5)	SMA Male x 1
	Bluetooth x 1	2400-2500	SMA Male x 1

FP40 ultra Kit	Port Configuration	Frequency (MHz)	Extension Cable Connector
9 Port Option 1 - Kit Part No. - L000434-01			
 +   	4G/5G Port x 4	617-960; 1427-1511; 1690-2700; 3300-7125	SMA Male x 4
	WLAN Port x 4	2400-2500; 4900-7125	RP-SMA Male x 4
	GNSS Port x 1	1427-1511 (L1 & L5)	SMA Male x 1
9 Port Option 2 - Kit Part No. - L000434-02			
 +   	4G/5G Port x 4	617-960; 1427-1511; 1690-2700; 3300-7125	Fakra D x 4
	WLAN Port x 4	2400-2500; 4900-7125	Fakra I x 4
	GNSS Port x 1	1427-1511 (L1 & L5)	Fakra C x 1
9 Port Option 3 - Kit Part No. - L000434-03			
 +   	4G/5G Port x 4	617-960; 1427-1511; 1690-2700; 3300-7125	SMA Male x 4
	WLAN Port x 4	2400-2500; 4900-7125	RP-SMA Male x 4
	GNSS Port x 1	1427-1511 (L1 & L5)	SMA Male x 1
14 Port - Kit Part No. - L000434-08			
 +    	4G/5G Port x 4	617-960; 1427-1511; 1690-2700; 3300-7125	SMA Male x 4
	WLAN Port x 8	2400-2500; 4900-7125	RP-SMA Male x 8
	GNSS Port x 1	1427-1511 (L1 & L5)	SMA Male x 1
	Bluetooth x 1	2400-2500	SMA Male x 1

For ease of installation, high-port count antenna kits may not have all extension cables pre-attached.

FP40 ULTRA 4X4 MIMO: SPECIFICATIONS

The following specifications are representative of all models/port options in the **FP40 ultra** antenna family. Unless stated the data includes testing of the antenna only and does not include testing with a 5 meter (16 feet) extension cable. For more detailed information please contact us.



ELECTRICAL SPECIFICATION - 4G/5G/CBRS (CELLULAR), WI-FI & BLUETOOTH										
	4G/5G/CBRS (Cellular)						Wi-Fi			Bluetooth
Operating Frequency (MHz)	617-960	1427-1511	1690-2700	3300-4200	4400-6000	6000-7125	2400-2500	4900-6000	6000-7125	2400-2500
Peak Gain - Max (dBi)*	4.0	8.0			9.0	7.0	7.5	8.5	9.5	6.0
Total Efficiency Average (%)*	42	41	61	61	54	49	50	51	53	54
Isolation - Cellular-to-Cellular/BT Elements (dB)**	13	21	20	26	34	38	N/A			22
Isolation - Wi-Fi-to-Wi-Fi Elements (dB)**	N/A						22	22	27	N/A
Max Power @ Ambient 20°C (Watts)	10						1			
Nominal Impedance (Ohms)	50									
Polarization	Linear									
Azimuth Beamwidth	360°, Omnidirectional									

*Measured with 0.3m (1 ft) coax cable

**Measured with 0.3m (1 ft) pigtail + 5m (16ft) 0.195" diameter extension cable

ELECTRICAL SPECIFICATION - GNSS***				
Number of Ports	1			
Frequency (MHz)	L1 Band			L5 Band
	1561	1575.42	1602	1176.45
Patch/Passive Antenna Peak Gain (dBi)	-0.6	0.9	-0.5	-0.4
LNA Gain (dBi)	28 ± 3			
Noise Figure (dB)	< 3			
Input Max Power (dBm)	+10			
Nominal Impedance (Ohms)	50			
Out of Band Rejection (dBc)	350-520 MHz			> 65
	698-960 MHz			> 70
	1428-1511 MHz			> 40
	1710-2700 MHz			> 65
	4900-5800 MHz			> 75
DC Voltage (V)	2-5			
Current (mA)	12.5 Typ. (at DC 3.0V)			

***Measured on 0.6 x 0.6m (2 x 2ft) ground plane

EXTENSION CABLE ATTENUATION FIGURES - 5MM (0.195 INCH) CABLES

Frequency Range (MHz)	698	960	1511	2500	2700	3300	4200	4400	4900	6000	7125
Cable Attenuation (dB/m)	< 0.3	< 0.4	< 0.5	< 0.7	< 0.7	< 0.8	< 0.9	< 1.0	< 1.1	< 1.2	< 1.3

MECHANICAL SPECIFICATION

Installed Dimensions HxDia mm (in.)	66.5 x 187 (2.62 x 7.4)
Max Weight - g (oz.) - Not Including Extension Cables	479 (16.9) - 612 (21.59) - Dependent on Model
Number of Ports	4 to 14 Port Options Available
Mounting Type	Fixed Stud M20
Radome	Polycarbonate, UL94-V0
Baseplate Material	Aluminium

ENVIRONMENTAL SPECIFICATION

Operating Temperature - °C (°F)	-40 to +85 (-40 to +185)
Storage Temperature - °C (°F)	-40 to +85 (-40 to +185)
Ingress Protection	IP67, IP69K
UV Rating	ASTM D4674
Flammability Rating	Radome: UL94 V0 Cable: UN ECE R118
Mechanical Shock Rating	IEC 60068-2-27, Secured Cross Country Vehicles
Vibration Test Rating	MIL-STD-810G, Method 514.6, Category 4, Highway Truck Vibration
Humidity Rating	MIL-STD-810G, 507.5, Procedure II, Aggravated Humidity @ 95%
Material Substance Compliance	RoHS Compliant CE & UKCA Compliant - Antenna

GLOBAL 4G, 5G, CBRS CELLULAR COVERAGE

The FP40 ultra antenna family provides truly global cellular coverage. The table below shows the frequencies and bands covered and the corresponding performance across those bands is shown in the charts below.

FREQUENCY	RF BANDS COVERED
617-698 MHz	71
698-960 MHz	5, 6, 8, 12, 13, 14, 17, 18, 19, 20, 26, 27, 28, 29, 44, 67, 68, 85 N5, N8, N12, N14, N18, N20, N28, N29, N81, N82, N83, N89, N91, N92, N93, N94
1427-1511 MHz	11, 21, 32, 45, 74 N50, N51, N74, N75, N76
1690-2700 MHz	1, 2, 3, 4, 7, 9, 10, 15, 16, 23, 25, 30, 33, 34, 35, 36, 37, 38, 39, 40, 41, 65, 66, 69, 70 N30, N34, N38, N39, N40, N41, N65, N66, N70, N80, N84, N86, N90, N95
3300-4200 MHz	22, 42, 43, 48 N48, N77, N78
4400-6000 MHz	N79
6000-7125 MHz*	46, 47 N96, N102, N104

4G, 5G, CBRS CELLULAR PERFORMANCE

TYPICAL VSWR

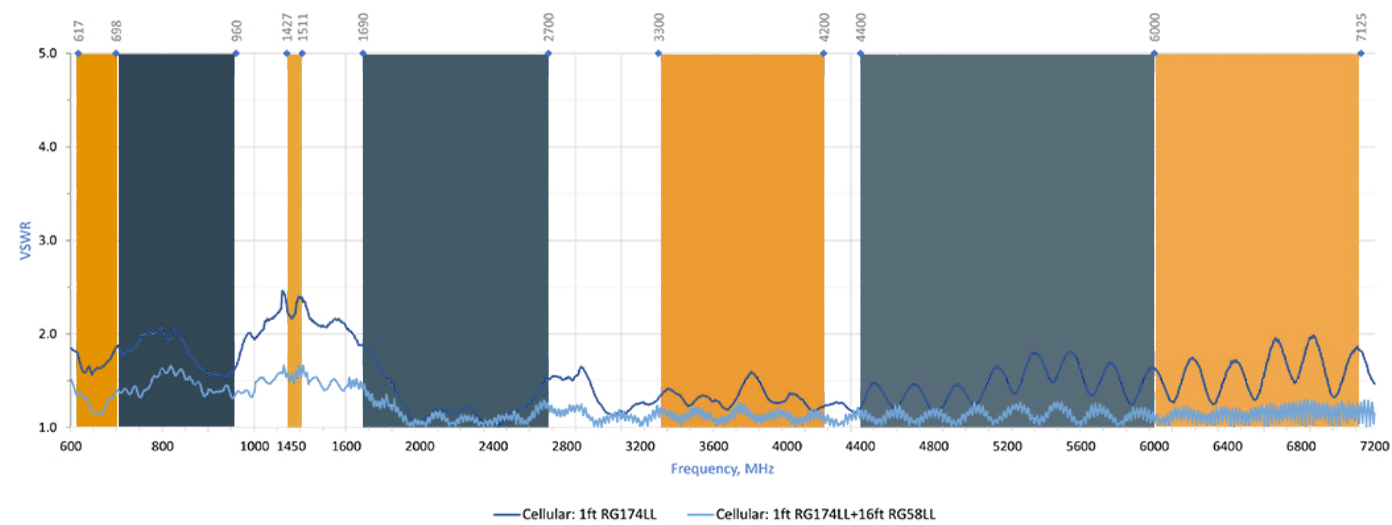

4G, 5G, CBRS CELLULAR PERFORMANCE

GAIN MAX (DBI)

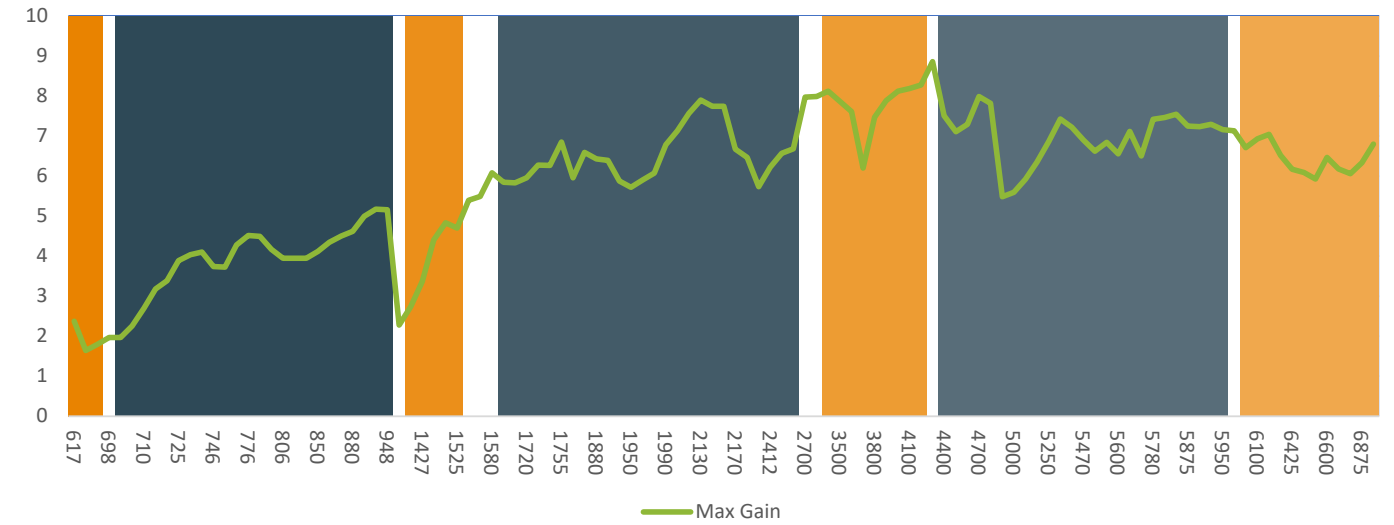

AVERAGE EFFICIENCY

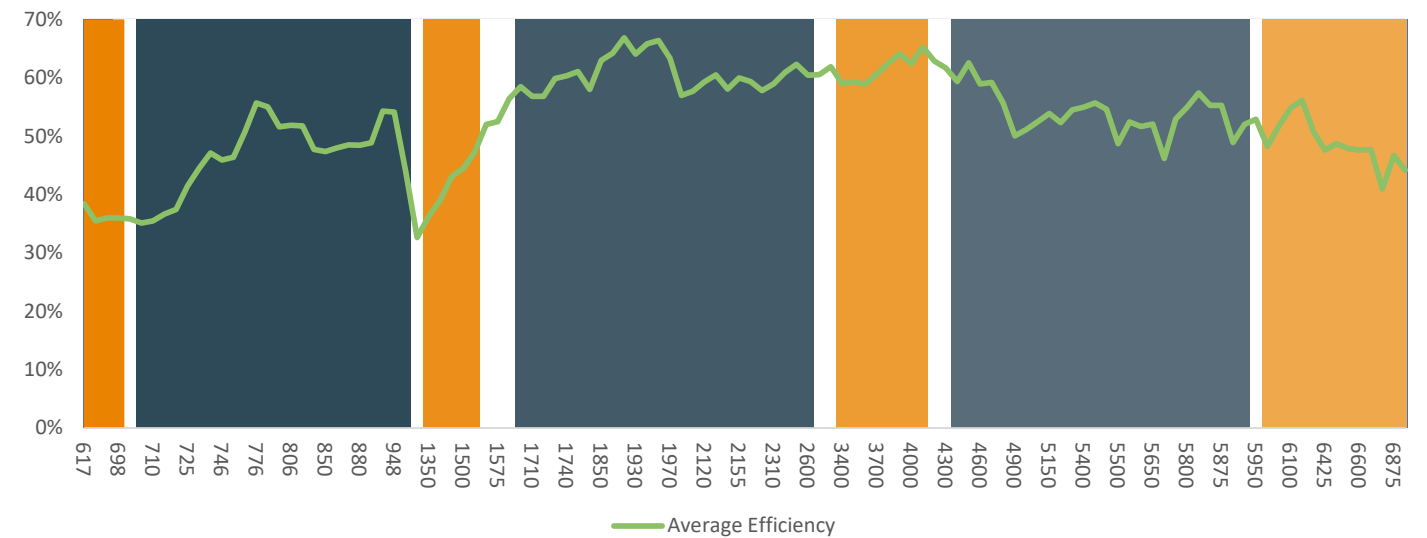

WI-FI AND BLUETOOTH PERFORMANCE

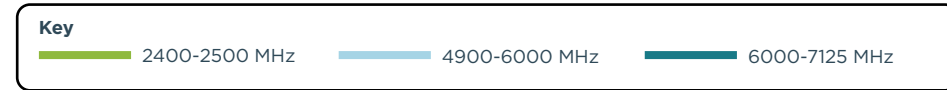

TYPICAL VSWR - WI-FI

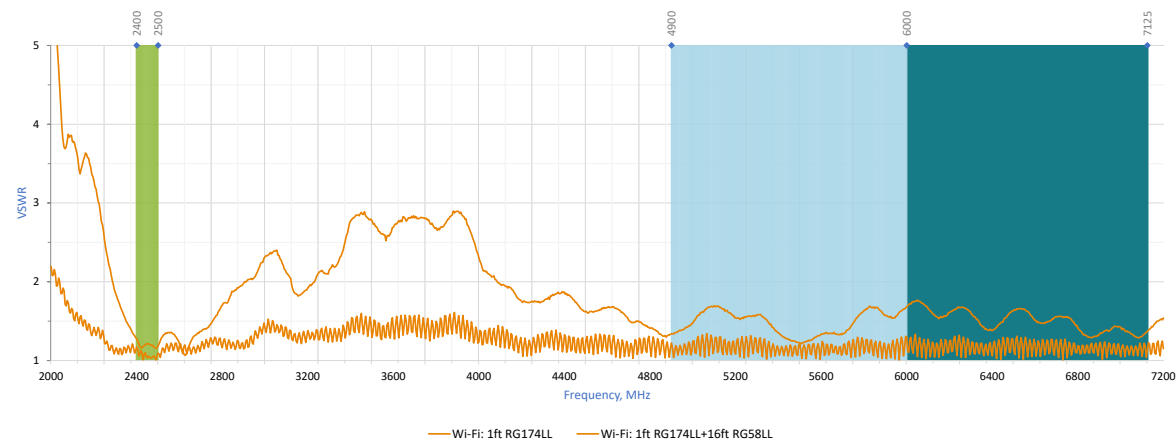

GAIN MAX (DBI) - WI-FI

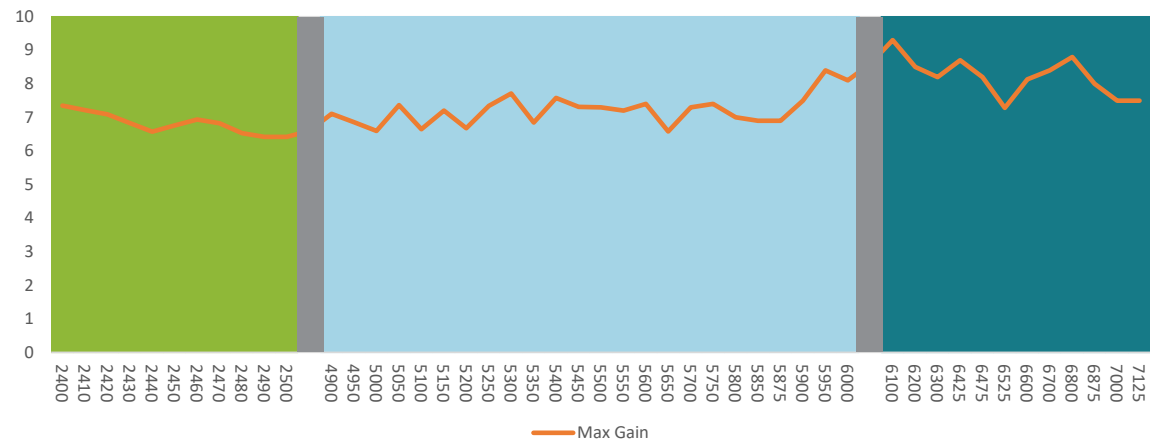

AVERAGE EFFICIENCY - WI-FI

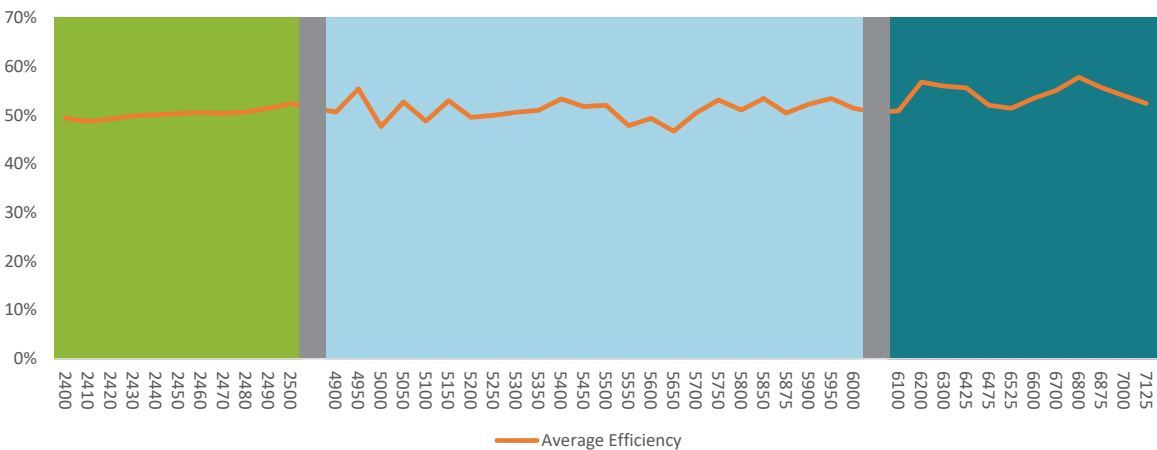

FP40 ULTRA 4X4 MIMO: RADIATION PATTERNS

The patterns below are representative of the typical performance of all **FP40 ultra** 4x4 MIMO antenna models. Patterns are recorded without the extension cable added and are four element (cellular) or up to eight element (Wi-Fi) simulated composite data. Please contact us for full test data. These antennas will perform on and off a ground plane. Performance may vary slightly when no ground plane is used in conjunction with these antennas. If you require test data for both scenarios please get in touch.

4G/5G/CBRS (CELLULAR)

Radiation Patterns at 617 MHz

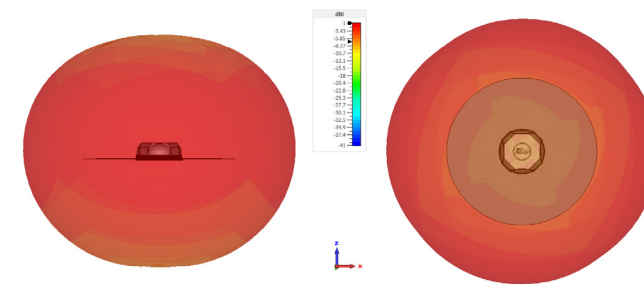

Radiation Patterns at 698 MHz

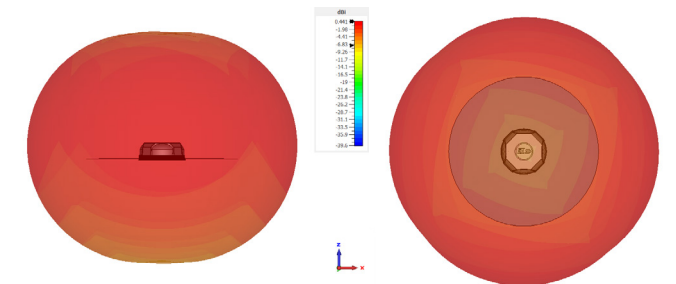

Radiation Patterns at 850 MHz

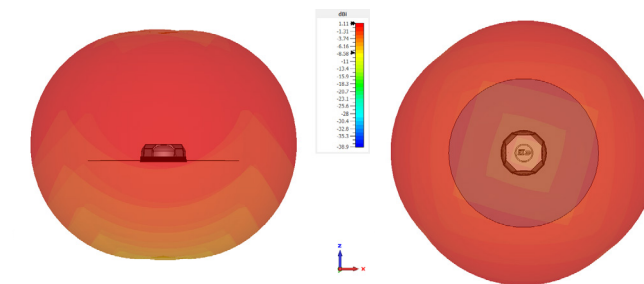

Radiation Patterns at 960 MHz

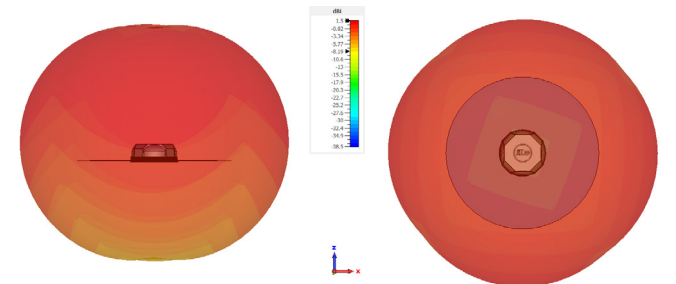

Radiation Patterns at 1500 MHz

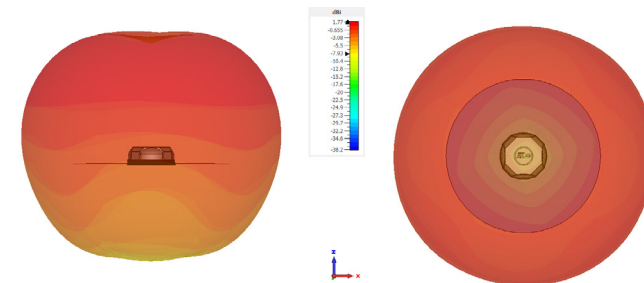

Radiation Patterns at 1690 MHz

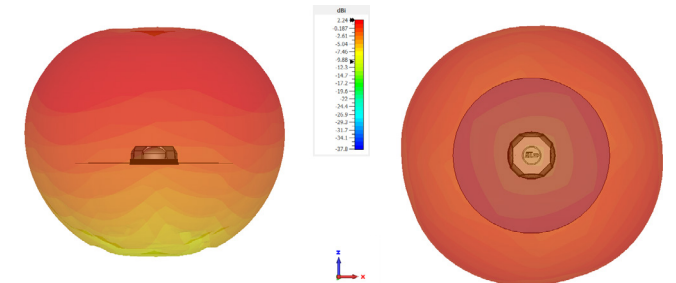

Radiation Patterns at 1850 MHz

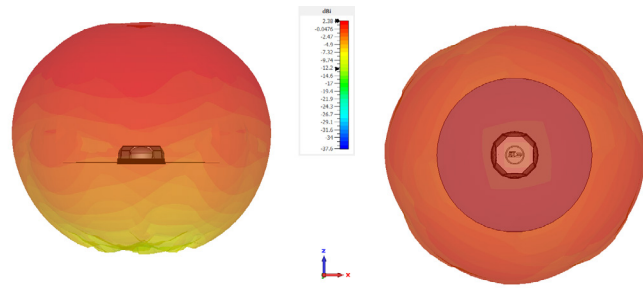

Radiation Patterns at 2170 MHz

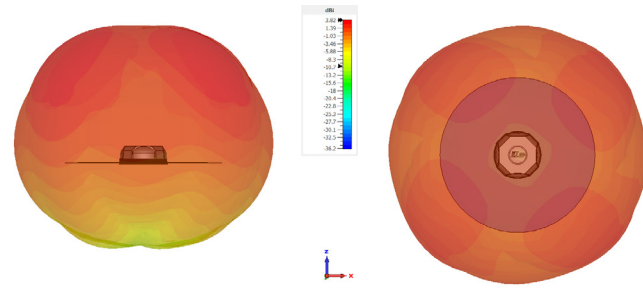

Radiation Patterns at 2500 MHz

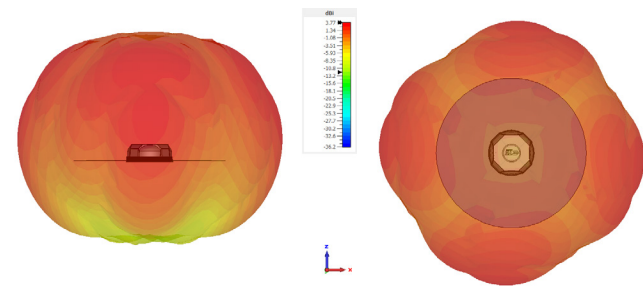

Radiation Patterns at 2700 MHz

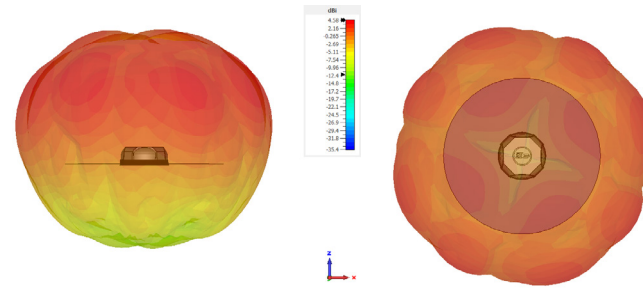

Radiation Patterns at 3500 MHz

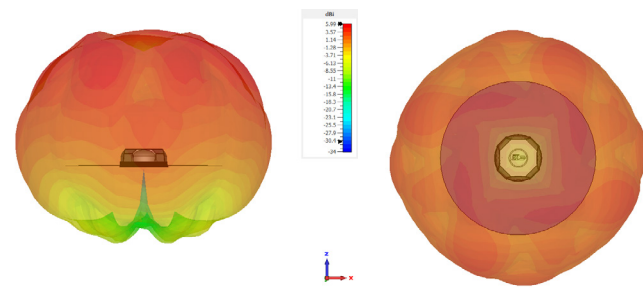

Radiation Patterns at 4900 MHz

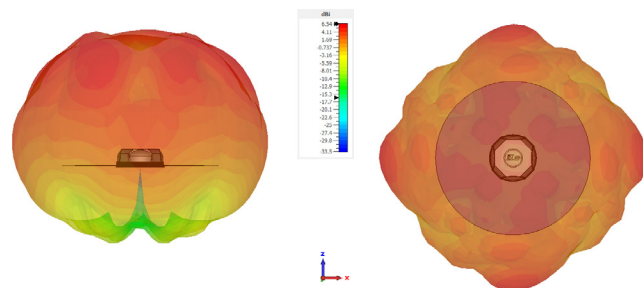

Radiation Patterns at 6000 MHz

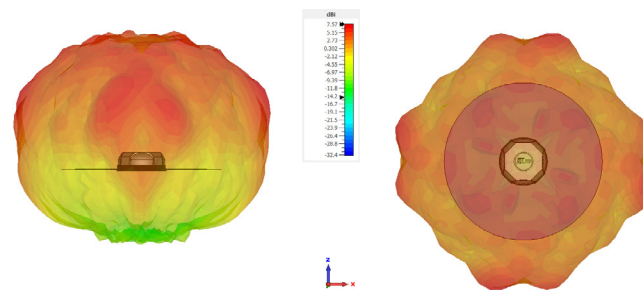

Radiation Patterns at 7125 MHz

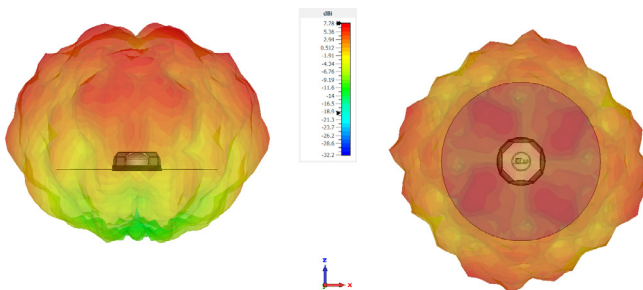

WI-FI & BLUETOOTH

Radiation Patterns at 2400 MHz

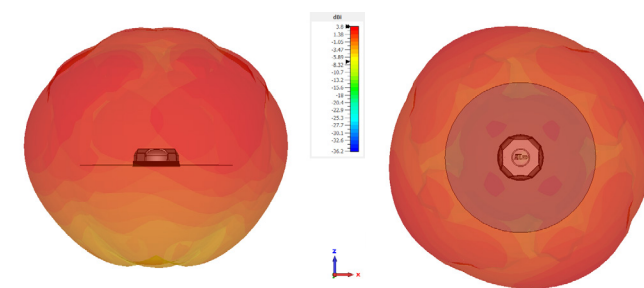

Radiation Patterns at 2450 MHz

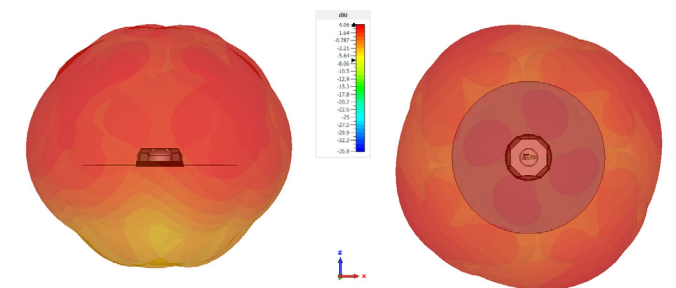

Radiation Patterns at 2500 MHz

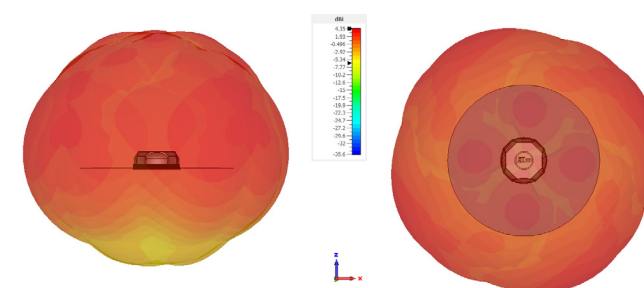

Radiation Patterns at 4900 MHz

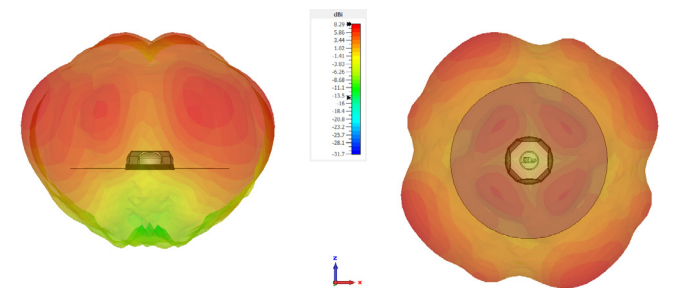

Radiation Patterns at 5500 MHz

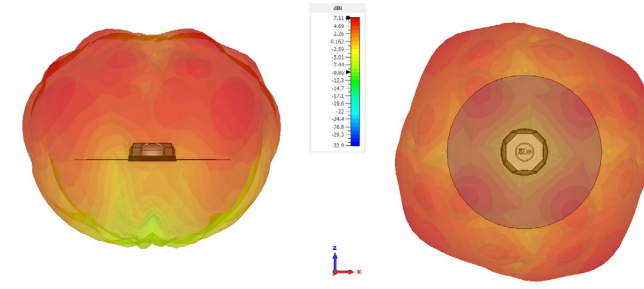

Radiation Patterns at 6000 MHz

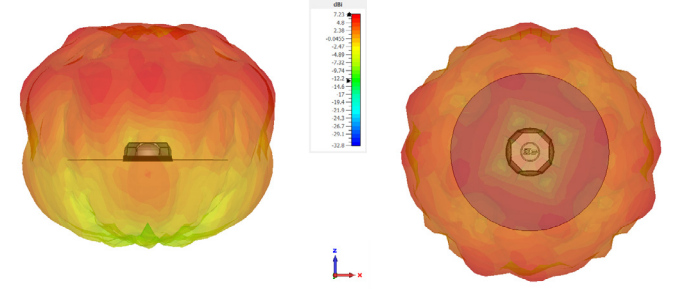

Radiation Patterns at 7125 MHz

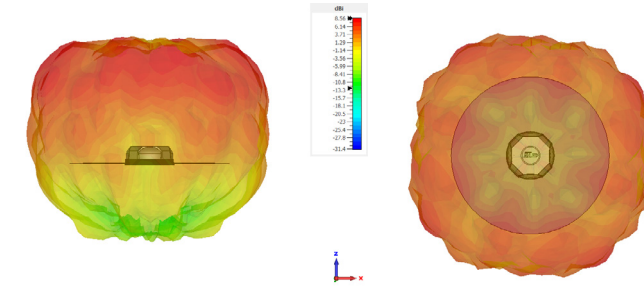

FP40 ULTRA 4X4 MIMO: DRAWINGS

MECHANICAL DRAWINGS

Installed/Compressed Height - 66.5mm (2.62 in.)

* H = 69.9mm (2.75 in.) From Bottom Gasket

** H = 68mm (2.68 in.) From Bottom Foam

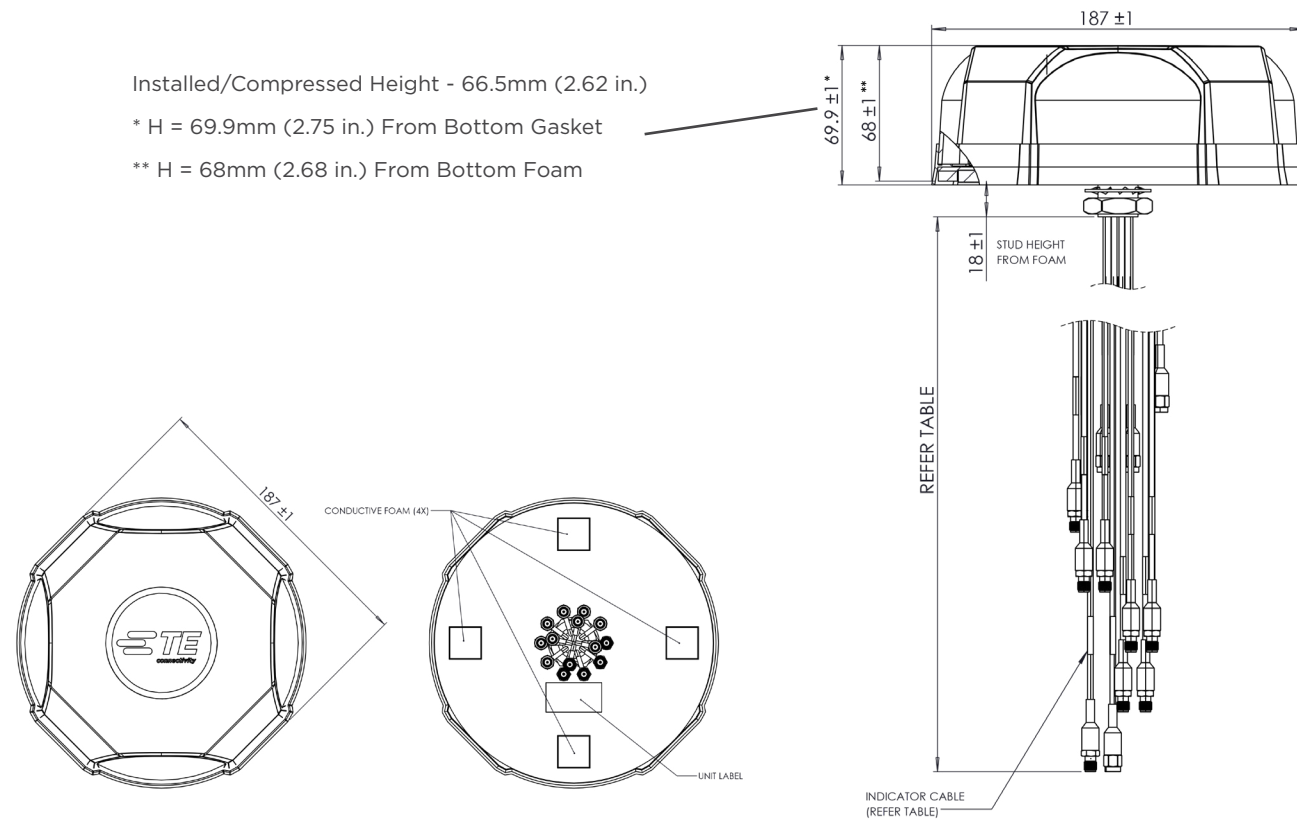

PACKAGING

FP40 ultra antennas will be shipped with the appropriate extension cable, in the kit configurations on pages 4-5 of this document. Extension cables will be pre-fitted to the antenna pigtail to reduce installation time. Shipping weights for each kit part number are shown below and quantities and dimensions on the following page.

Kit Part Number	Description	Estimated Master Carton Weight Kg (lbs)	Air Shipment Estimated Pallet Weight Kg (lbs)	Ocean Shipment Estimated Pallet Weight Kg (lbs)
L000434-01	9 Port: 4 x Cellular, 4 x Wi-Fi, 1 x GNSS	2.75 (6.06)	149.5 (329.59)	204.5 (450.85)
L000434-02	9 Port: 4 x Cellular, 4 x Wi-Fi, 1 x GNSS	2.75 (6.06)	149.5 (329.59)	204.5 (450.85)
L000434-03	9 Port: 4 x Cellular, 4 x Wi-Fi, 1 x GNSS	2.75 (6.06)	149.5 (329.59)	204.5 (450.85)
L000434-04	8 Port: 4 x Cellular, 2 x Wi-Fi, 1 x Bluetooth, 1 x GNSS	2.55 (5.62)	139.5 (307.55)	190.5 (419.98)
L000434-05	8 Port: 4 x Cellular, 2 x Wi-Fi, 1 x Bluetooth, 1 x GNSS	2.55 (5.62)	139.5 (307.55)	190.5 (419.98)
L000434-06	8 Port: 4 x Cellular, 2 x Wi-Fi, 1 x Bluetooth, 1 x GNSS	2.55 (5.62)	139.5 (307.55)	190.5 (419.98)
L000434-07	4 Port: 4 x Cellular	3.40 (7.50)	114 (251.32)	165 (363.76)
L000434-08	14 Port: 4 x Cellular, 8 x Wi-Fi, 1 x Bluetooth, 1 x GNSS	3.76 (8.29)	200 (440.93)	275.2 (606.71)

PACKAGING DIMENSIONS & QUANTITY

8-14 PORT KIT PACKAGING

Air Pallet

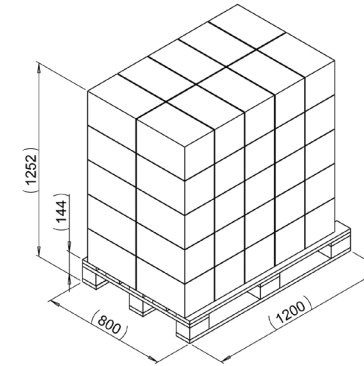

AIR SHIPMENT

- 1 ANTENNA PER MASTER CARTON
- 10 CARTONS PER LAYER
- 5 LAYERS PER PALLET
- TOTAL ANTENNAS PER PALLET = 50 PCS

Ocean Pallet

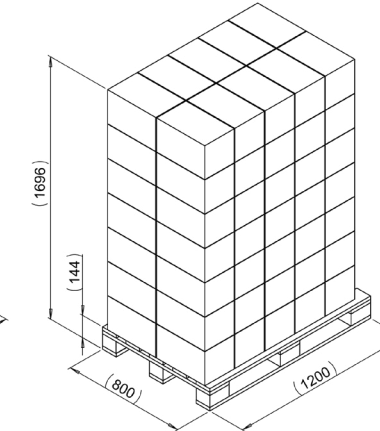

OCEAN SHIPMENT

- 1 ANTENNA PER MASTER CARTON
- 10 CARTONS PER LAYER
- 7 LAYERS PER PALLET
- TOTAL ANTENNAS PER PALLET = 70 PCS

Master Carton

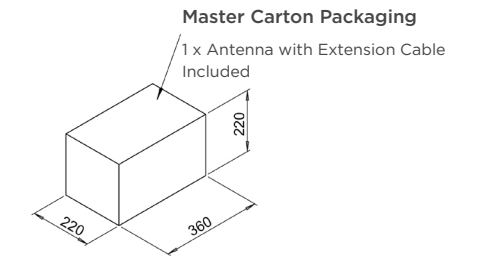

4 PORT KIT PACKAGING

Air Pallet

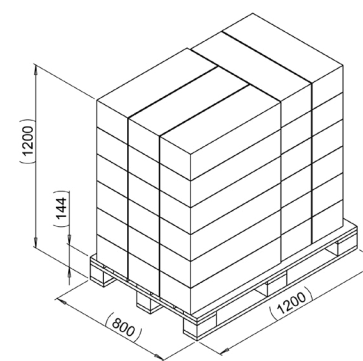

AIR SHIPMENT

- 3 ANTENNAS PER MASTER CARTON
- 5 CARTONS PER LAYER
- 6 LAYERS PER PALLET
- TOTAL ANTENNAS PER PALLET = 90 PCS

Ocean Pallet

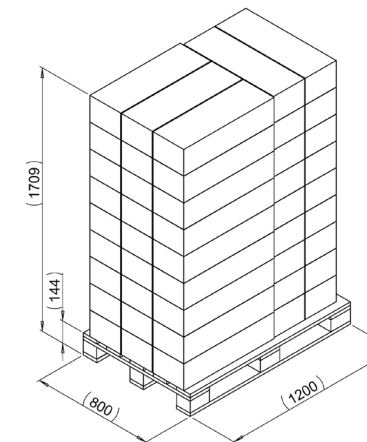

OCEAN SHIPMENT

- 3 ANTENNAS PER MASTER CARTON
- 5 CARTONS PER LAYER
- 9 LAYERS PER PALLET
- TOTAL ANTENNAS PER PALLET = 135 PCS

Master Carton

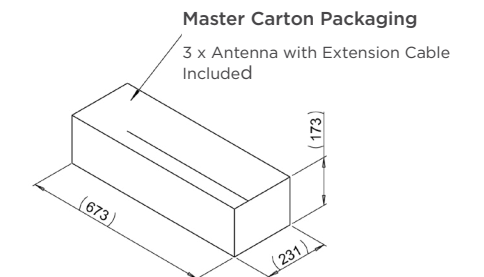

FP40 ULTRA 4X4 MIMO: APPLICATIONS

The examples below are intended to demonstrate just some of the scenarios and applications where **FP40 ultra** antennas may be used. There are many more possible scenarios and applications. If you are in any doubt about whether this is the correct antenna for your use, please contact us.



Public Transportation

Onboard connectivity is not only common but expected nowadays. In fact after arriving on time, a passenger's second concern is likely to be whether they can stream their favorite music and shows on the move. Other than **onboard Wi-Fi**, applications for public transportation can also include: **ticketing** (digital payments or apps); **navigation systems**; **security cameras**; **dispatch control**; **vehicle diagnostics** etc.



Emergency Services & Public Safety

Emergency services and public safety agencies around the world have an ever increasing need for high bandwidth data connectivity with applications such as: **dashcam footage**; **live video streaming**; **ANPR**; **facial recognition**; **finger print analysis** etc..



Utility & Repair Vehicles

Utility and repair vehicles often utilize a wide variety of connectivity in order to operate effectively including devices communicating with the vehicle through Wi-Fi, cloud uploads via 5G and location through GNSS. These requirements can be seen in the: **diagnostic equipment**; **augmented reality (AR)**; **live video streaming**; **software updates**; and **positioning/location services** used on a daily basis.

te.com

TE Connectivity, TE Connectivity (logo) and TE are trademarks. All other logos, products and/or company names referred to herein might be trademarks of their respective owners.

The information given herein, including drawings, illustrations and schematics which are intended for illustration purposes only, is believed to be reliable. However, TE Connectivity makes no warranties as to its accuracy or completeness and disclaims any liability in connection with its use. TE Connectivity's obligations shall only be as set forth in TE Connectivity's Standard Terms and Conditions of Sale for this product and in no case will TE Connectivity be liable for any incidental, indirect or consequential damages arising out of the sale, resale, use or misuse of the product. Users of TE Connectivity products should make their own evaluation to determine the suitability of each such product for the specific application.

©2023 TE Connectivity. All Rights Reserved.

03/23 Original

TECHNICAL SUPPORT CENTER

USA: +1 (800) 522-6752

Canada: +1 (905) 475-6222

Mexico: +52 (0) 55-1106-0800

Latin/S. America: +54 (0) 11-4733-2200

Germany: +49 (0) 6251-133-1999

UK: +44 (0) 800-267666

France: +33 (0) 1-3420-8686

Netherlands: +31 (0) 73-6246-999

China: +86 (0) 400-820-6015