



HEAT SHRINK WRAPAROUND SLEEVES CRSM

FOR CABLE JACKET REPAIR

KEY FEATURES

- Fast and easy fitting thanks to the channel which can be installed without special tools
- Reliable closure system and environmental seal with excellent bonding
- Cross-linked polyolefin material, halogen-free and non-corrosive. RoHS and REACH compliant
- Unlimited shelf-life when stored under normal conditions

TE's Raychem CRSM heat shrink wraparound sleeves fit easily onto the cable to repair the outer jacket and seal against moisture. The closure system consists of a raised rail profile and a stainless steel channel which can be installed without any special tools. The hot-melt sealant provides a reliable environmental seal.

Our CRSM wraparound sleeves are mainly used as insulation, sealing or as re-jacketing material for 1000V power cables, as well as cable jacket repair for Medium Voltage power cables. They may also be used as protection on various substrates, where installation space is tight or difficult to reach.

CRSM wraparound sleeves are halogen-free and stabilized against UV radiation, which ensures a long-term reliability in harsh environments. They have an unlimited shelf-life when stored under normal conditions.

Customers can count on consistent, high quality products, driven by TE's proven innovation and backed by our extraordinary customer support.

Heat Shrink Wraparound Sleeves CRSM



TECHNICAL FEATURES		
Physical Characteristics	Test Method	Material Requirements
Tensile Strength	ISO 37	≥ 15 MPa
Ultimate Elongation	ISO 37	≥ 350%
Hardness	ISO 868	≥ 40 Shore D
Low Temperature Flexibility	ASTM D 2671 Procedure C	No cracking at 4 hours at -30°C ± 3°C
Dielectric Strength	IEC 60684-2	≥ 12 kV/mm
Volume Resistivity	IEC 62631-3-2	≥ 1 × 10 ¹² Ohm cm
Water Absorption	ISO 62 method 1	≤ 0.5% max after 14 days at 23°C ± 2°C
Corrosion	ASTM D2671 Part A	No corrosion after 16h at 150°C ± 2°C
UV Resistance	The material from which CRSM is manufactured contains carbon black (≥ 2,5 %) to protect it from ultra-violet light	
Accelerated aging 7 days at 150°C ± 2°C		
Tensile Strength	ISO 37	≥ 10 MPa
Ultimate Elongation	ISO 37	≥ 350%
Chemical Characteristics		
Resistance to Liquids	-	-
Tensile Strength	ISO 37	≥ 14 MPa
Ultimate Elongation	ISO 37	≥ 350%
Application Characteristics		
Operating Temperature Range	-	- 30°C up to + 85°C
Shrink Ratio	-	> 3:1
Longitudinal Shrinkage Free Recovered	-	- 10% max

PRODUCT SELECTION INFORMATION - DIMENSIONS ARE IN (mm)						
Description	Application Range		Diameter H		Thickness W	
	min	max	Expanded min	Recovered max	Expanded min	Recovered min
CRSM 34/10	11	27	34	10	0.3	2.4
CRSM 53/13	15	43	53	13	0.3	2.4
CRSM 84/20	22	68	84	20	0.3	2.4
CRSM 107/29	32	86	107	29	0.3	2.4
CRSM 143/36	40	115	143	36	0.3	2.4
CRSM 198/55	60	160	198	55	0.3	2.4

All sizes are available in the standard lengths P 250, 500, 750, 1000, 1200 and 1500 mm. All lengths are subject to standard cutting tolerances. TE's Raychem CRSM wraparound sleeves are available coated with an inner sealant wall.

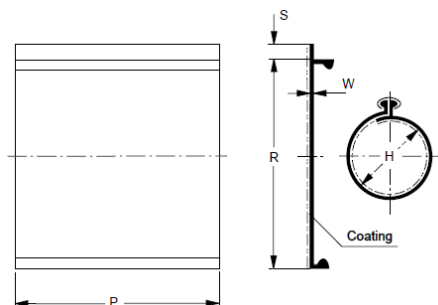

FOR MORE INFORMATION: TE Technical Support Centers

USA:	+ 1 800 327 6996
Canada:	+ 1 (905) 475-6222
Mexico:	+ 52 (0) 55-1106-0800
Latin/S. America:	+ 54 (0) 11-4733-2200
France:	+ 33 380 583 200
UK:	+ 44 0870 870 7500
Germany:	+ 49 896 089 903
Spain:	+ 34 916 630 400
Italy:	+ 39 333 250 0915
Benelux:	+ 32 16 508 695
Russia:	+ 7 495-790 790 2-200
China:	+ 86 (0) 400-820-6015

te.com/energy

© 2019 TE Connectivity. All Rights Reserved. EPP-3272-EN-8/19-IEC

Raychem, TE Connectivity and TE connectivity (logo) are trademarks. Other logos, product and/or company names might be trademarks of their respective owners. While TE has made every reasonable effort to ensure the accuracy of the information in this brochure, TE does not guarantee that it is error-free, nor does TE make any other representation, warranty or guarantee that the information is accurate, correct, reliable or current. TE reserves the right to make any adjustments to the information contained herein at any time without notice. TE expressly disclaims all implied warranties regarding the information contained herein, including, but not limited to, any implied warranties of merchantability or fitness for a particular purpose. The dimensions in this catalog are for reference purposes only and are subject to change without notice. Specifications are subject to change without notice. Consult TE for the latest dimensions and design specifications.