



8931N WIRELESS VIBRATION SENSOR

LoRaWAN™ 868/915MHz

TECHNICAL SPECIFICATIONS

- Wireless Piezoelectric Three Axis Accelerometer
- Designed for Condition Monitoring
- Programmable and Customer Configurable
- Corrosion Resistant Stainless-Steel Housing
- Wide Bandwidth to 10kHz
- Exceptional Long Term Stability
- Superior Measurement Resolution
- ATEX certified
- Explosive Atmospheres Certified

FEATURES

- Compact design
- Up to 4-year battery life
- -40°C to +60°C operating temperature
- 35kHz resonant frequency
- Embedded FFT signal analysis
- Stud, magnet, or adhesive mounting accessories

APPLICATIONS

- Condition based monitoring
- Electric motors
- Oil & gas equipment
- ICE powerplants
- Pumps for liquids
- Compressors
- Factory equipment
- Robots and cobots
- Autonomous guided vehicles
- HVACR equipment

INTRODUCTION

The TE model 8931N wireless vibration sensor combines three accelerometers, a data collector, and a radio into one compact, battery-operated device that measures both vibration and temperature data. It was designed for harsh environment and comes with the ATEX certification.

The model 8931N wireless accelerometer uses the LoRaWAN™ communication protocol, offering a simple, reliable, and secure means of expanding condition-based maintenance into plant areas where the cost to install wired systems is prohibitive, making data available to existing process control and information systems. In addition to that, it offers a Bluetooth Low Energy interface to ease the embedded settings configuration at the sensor installation.

The model 8931N incorporates three piezo-electric accelerometers which offer a wide bandwidth to 10kHz, outstanding measurement resolution and superior long-term stability compared to design using MEMS solutions. The accelerometers are oriented at 90° to each other providing data in X, Y, and Z directions.

The 8931N contains digital signal processing capability that provides an FFT analysis of the sensed vibration. The output data describes the center frequency, peak value, bandwidth, and percent of the total spectral content for the eight most significant acceleration peaks in the vibration signal from each axis.

Because of this feature, the 8931N directly provides the data most needed to plot trends and monitor changes in the performance and condition of factory machinery.

REVISIONS

DATE	Revision	Change Description	Prepared by	Approver
10/31/2022	Rev 0.1	Initial draft NEW Version		PRS
11/07/2022	Rev 0.2	Revise Mounting accessories		PRS
11/09/2022	Rev 0.3	Update Certification Information		PRS
	Rev 0.4	Add Explosive compliance Sec 1.8, Pg 1 Revise test cond temps from 24 to 25°C Update temp range NX vs EX Update image pg 1 Add 3.6.1 & 3.6.2 & images for BLE		PRS
1/12/2023	Rev 0.5	Remove block diagram Revise radiation exposure statement		PRS
1/23/2023	Rev 0.6	Update EU Conformity statement Add graphics for first hour operation Update magnet location image Update BLE screen images Revise Preset intervals and graphics Revise FFT explanation section		PRS
1/30/2023	Rev 0.7	Many corrections to text regarding 8911 vs 8931, LoRa vs LoRaWAN™, update state machine diagram		PRS
2/07/2023	Rev 0.8	Update temperature specs throughout Revise basic sensitivity from ±50g to ±25g Remove graph referencing battery life vs SF Rewrite all battery life references		PRS
02/07/2023	Rev 0.9	Correct 8911 ref in sec 6.2		PRS
03/28/2023	Rev 0.10	Update lower frequency limits to match 830M1 Update Ordering Information Page Update TCPN Kit part numbers		PRS
04/06/2023	Rev 0.11	Update and edit text in Section 9 Regulatory Statements		PRS
04/24/2023	Rev 0.12	Change battery life references to 4 years Change freq response to 2 to 10kHz @ 3db Change resonant freq to 35kHz Change resolution to 14 bits Change residual noise to 9mg max Change cover mat'l from POM to PET Change Xmit power to +8dbm Change Rec sensitivity to -128±1dbm Update part number ordering table Update Regulatory certifications Update and add product images		
09/06/2023	Rev 0.13	Updated LoRa TX power Updated Kit Ordering Numbers Updated TE SensorConnect app section		MAC

REFERENCES

Other documents that may be sources of reference for material discussed in this publication:

- 8931N User Manual, Doc# xxxxxx
- 8931N Installation Manual, Doc# 20023687-24
- 8931N Quick Start Guide, available on TE.com

TABLE of CONTENTS

1.	Performance Specifications	6
1.1.	ABSOLUTE MAXIMUM RATINGS ⁽¹⁾	6
1.2.	ELECTRICAL SPECIFICATION	6
1.3.	OPERATING SPECIFICATIONS (ACCEL).....	6
1.4.	OPERATING SPECIFICATIONS (TEMP).....	7
1.5.	ENVIRONMENTAL SPECIFICATIONS	7
1.6.	COMMUNICATION SPECIFICATIONS (LORA)	7
1.7.	COMMUNICATION SPECIFICATIONS (BLE)	8
1.8.	COMPLIANCE INFORMATION.....	8
2.	General Description	9
2.1.	DEVICE START-UP	9
2.2.	MODES OF OPERATION.....	12
2.3.	DATA COLLECTION	12
2.4.	DATA PROCESSING	13
2.5.	COMMUNICATION – LoRaWAN™	17
2.6.	BLUETOOTH® LOW ENERGY.....	17
2.6.1.	Bluetooth™ App for Mobile Device Communication	18
2.6.2.	BLE screen examples.....	18
3.	Magnetic Switch.....	19
4.	LED Indicator	20
4.1.	LoRaWAN™ Join request examples.....	20
4.2.	LoRaWAN™ Uplink transmission Examples	21
5.	Presets.....	22
5.1.	MANAGING PRESETS.....	23
5.2.	ROTATING PRESET MODE	24
6.	Battery.....	25
6.1.	BATTERY TYPE	25
6.2.	BATTERY LIFE.....	25

6.3.	BATTERY REPLACEMENT	26
7.	Dimensions.....	26
8.	Mounting Considerations & Accessories	27
9.	Regulatory Statements	29
10.	Intrinsic Safety Models.....	30
11.	Ordering Information.....	31
12.	Additional Notes:	34

1. Performance Specifications

1.1. ABSOLUTE MAXIMUM RATINGS⁽¹⁾

Parameter	Symbol	Min	Typ	Max	Unit	Notes/Conditions
Supply voltage	V _{dd}			3.6	V	Replaceable battery
Storage temperature	T _S	-40		80	°C	Without battery
Shock limit	g _{max}			2000	g	1Hz to 10kHz
ESD		-2		+2	kV	Human body model

⁽¹⁾ Maximum limits the device will withstand without damage

1.2. ELECTRICAL SPECIFICATION

(Unless otherwise specified, all parameters are measured at 25°C @ 3.0V applied)

Parameters	Symbol	Min	Typ	Max	Unit	Notes/Conditions
Power Supply	V _{dd}		3		Vdc	Replaceable battery SAFT17330
Average supply current	I _{avg}		35		μA	
Peak supply current	I _{pk}			50	mA	During Xmit (LoRa)
Resolution				14	bits	
Sampling Time				5	Sec	
Battery Life			4		Years	One sample/hr (SF7)

1.3. OPERATING SPECIFICATIONS (ACCEL)

(Unless otherwise specified, all parameters are measured at 25°C @ 3.0V applied)

Parameter	Symbol	Min	Typ	Max	Unit	Notes/Conditions
Dynamic range			±25		g	X, Y, Z axis
Frequency response		2		10k	Hz	±3db (3 axes)
Resonant frequency	f _o		35		kHz	3 axes
Transverse sensitivity			5		%	3 axes
Temperature sensitivity	T _c	-10		5	%	From -20 to 60°C
Non-linearity			±1		%	FSO
Resolution			14		bits	
Residual noise				9	mg	RMS
Sensitive axes		Three orthogonal (X-Y-Z) bidirectional axes with Z being perpendicular to the mounting surface				

1.4. OPERATING SPECIFICATIONS (TEMP)

Unless otherwise specified, all parameters are measured at 25°C @ 3.0V applied)

Parameter	Symbol	Min	Typ	Max	Unit	Notes/Conditions
Temp measurement range	T _r	-40		80	°C	
Accuracy			±2.0		°C	-30 to +60
Resolution			14		bits	

⁽¹⁾The temperature sensor is located inside the sensor enclosure. As such, it provides the temperature of the sensor interior, not the ambient temperature around the sensor, nor the temperature of surface to which the sensor is mounted.

1.5. ENVIRONMENTAL SPECIFICATIONS

Parameter	Symbol	Min	Typ	Max	Unit	Notes/Conditions
Operating temperature		-40		+60	°C	With battery
Storage temperature		-40		+80	°C	Without battery
Ambient humidity		0		95	%	Non-condensing
EMI/RFI/ESD protection			IEC61000-4-2, ICE61000-4-6			
Ingress protection	IP		IP66/IP67			
Media compatibility			External exposed surfaces: 316L stainless steel PET polymer EPDM o-ring			
Weight			200		grams	

1.6. COMMUNICATION SPECIFICATIONS (LORA)

Parameter	Symbol	Min	Typ	Max	Unit	Notes/Conditions
Wireless protocol		LoRaWAN™ Class A				
Operating freq (region)		868 (EU) 915 (USA)			MHz	Other frequencies available Contact factory
Transmit power			6	8	dBm	
Receiver sensitivity			-131	-137	dBm	
Activation		OTAA				
Activation keys		Factory defined				Custom keys available Contact factory

1.7. COMMUNICATION SPECIFICATIONS (BLE)

Parameter	Symbol	Min	Typ	Max	Unit	Notes/Conditions
Wireless protocol			BLE 5.0			
Operating freq			2.4		GHz	
Transmit power			+0		dBm	
Receiver sensitivity		-127		-129	dBm	
Advertising interval			1		sec	Factory default

1.8. COMPLIANCE INFORMATION

Compliance Type	Region
Bluetooth Signal Compliance	All
LoRaWAN™ Certification	United States, Canada, Europe (EU)
FCC Certified	United States
ISED Certified	Canada
RED Compliance	Europe (EU)
RoHS Compliance	
Explosive Atmospheres Certifications	United States, Canada, ATEX, IECEx

See Ordering Information for applicable codes

2. General Description

Refer to the User Manual (Doc# xxxxxxxx) for a detailed explanation of all sensor features and functions.

The 8931N vibration sensor has two BLE modes and one LoRaWAN™ mode:

- BLE advertising mode - Starts automatically when the battery is inserted. Advertising occurs at a rate of once per second.
- BLE connected mode – After each advertisement, the user can initiate a change to connected mode. When connected, the user can configure the device and use other special features.
- LoRaWAN™ mode – Used to communicate with an external network. The device can also be configured via LoRaWAN™ during the first hour after connection.

2.1. DEVICE START-UP

- 1) Insert battery (refer to Installation Manual – Doc #20023687-24). On-board LED will flash once upon proper installation.
- 2) The sensor will begin BLE advertising at the rate of once per second. This rate is not correlated with the measurement interval.
- 3) After the first BLE measurement, the sensor will transmit a “Join Request” on the LoRaWAN™ frequency. If successful, sensor data will be transmitted via uplink messages at intervals determined by the sensor default settings. BLE features are disabled during the LoRa communications.
- 4) Once LoRaWAN™ communications are complete, the sensor will revert back to BLE advertising mode.
- 5) During advertising, the user can respond and establish the BLE “Connected” mode. While in Connected mode, the user can configure LoRaWAN™ transmit interval and FFT features.
- 6) At sixty minutes after start-up, all BLE features are disabled, and data communications will only proceed via the LoRaWAN™ connection protocol. The measurement interval will follow the settings established during the BLE Connected mode time. The sensor configuration can be adjusted via LoRaWAN™ communications just as it was during the initial sixty-minute BLE time.
- 7) At any time after the initial sixty-minute BLE mode operation, a new sixty-minute period can be initiated by placing a magnet close to the magnet symbol on the sensor housing. Depending on the how long the magnet is applied, either the new BLE mode can be initiated, or the sensor can be reset. See section 4 regarding the Magnetic Switch.

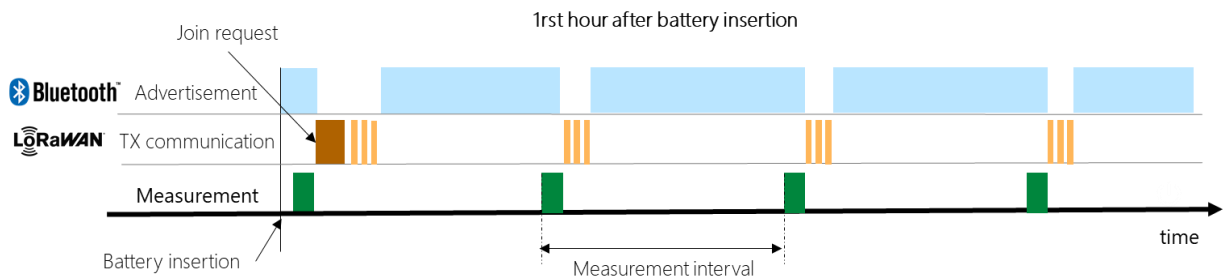
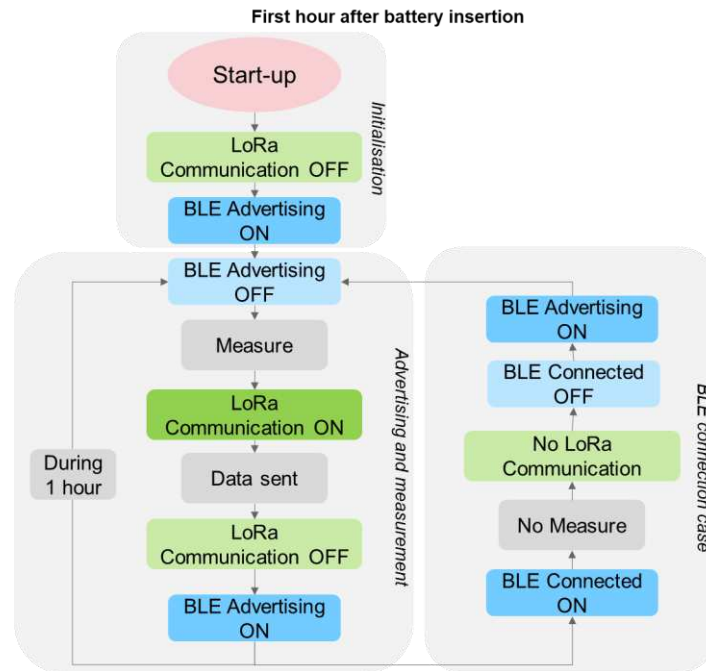

8) One hour after start-up:

- BLE is disabled
- Data communication will proceed only via the LoRaWAN™ connection. The device will be in the idle state between transmissions.
- If the LoRaWAN process was completed successfully at start-up, the processed data is transmitted via three uplink messages in sequence. The measurement will follow the settings established during the BLE Connected mode time. The sensor configuration can be adjusted via LoRaWAN™ communications just as it was during the initial sixty-minute BLE time.

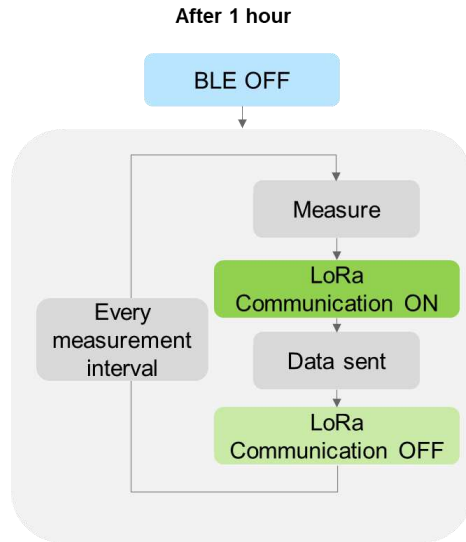

2.2. MODES OF OPERATION

The device operation can be summarized by the following state machine diagram.

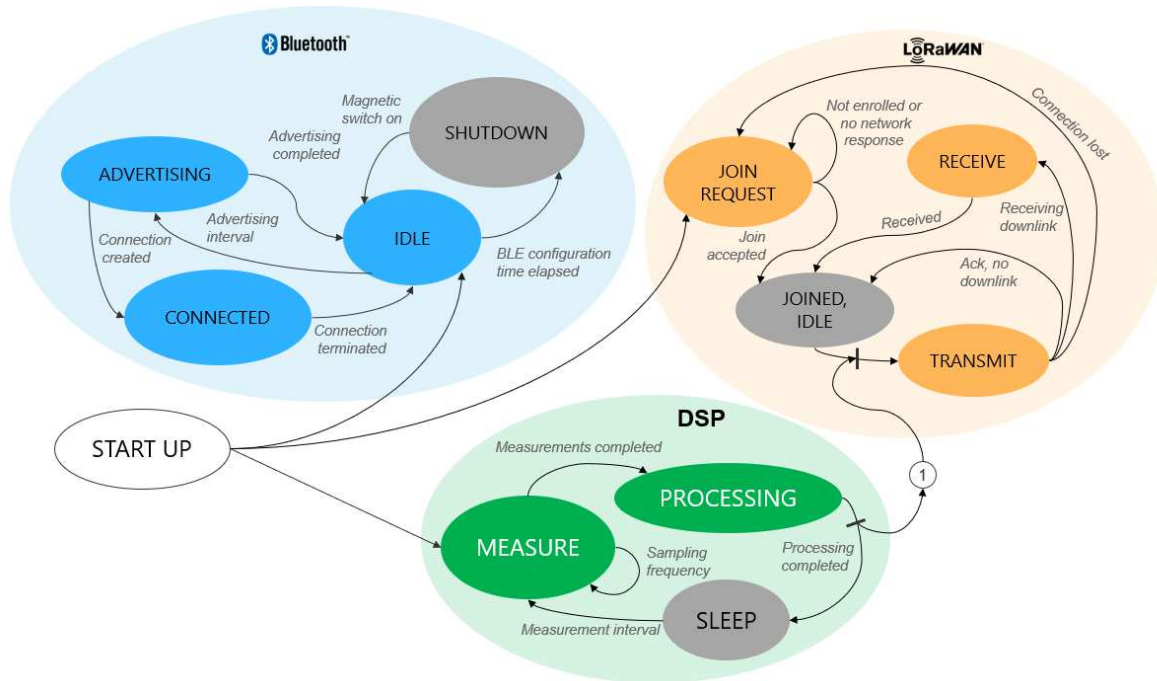

2.3. DATA COLLECTION

Sensor measurements are performed and transmitted at a configurable interval from 15 min up to 24 hours. This is driven by the *Measurement interval* parameter.

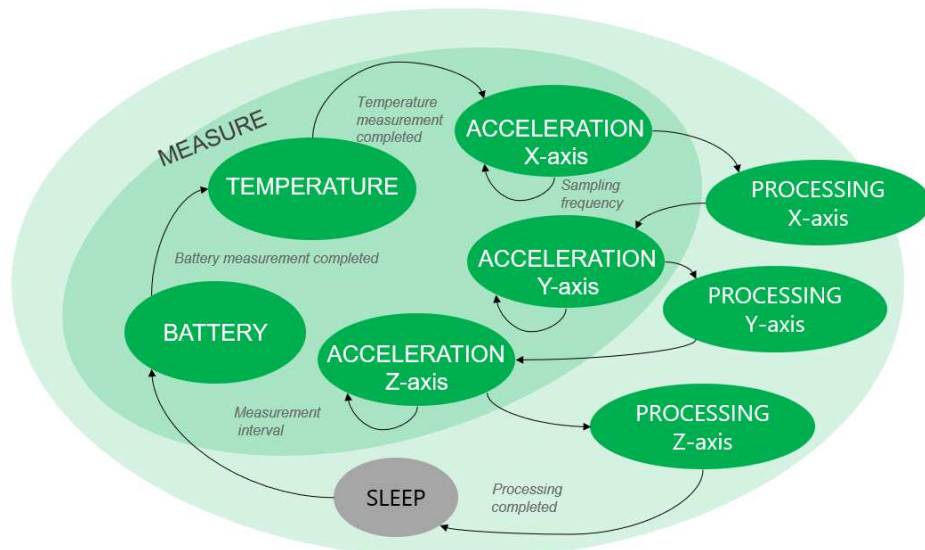

Upon wake-up, the device powers the sensing element and waits for about 3 seconds to let the accelerometer boot and stabilize its output.

A measurement consists of reading the battery level, temperature, and a set of 4096 acceleration values per axis at a configurable rate.

Data	Unit	Accessibility
Battery level	%	LoRaWAN™, BLE
Temperature	°C	LoRaWAN™, BLE
Acceleration	mg	LoRaWAN™, BLE (FFT peaks only)

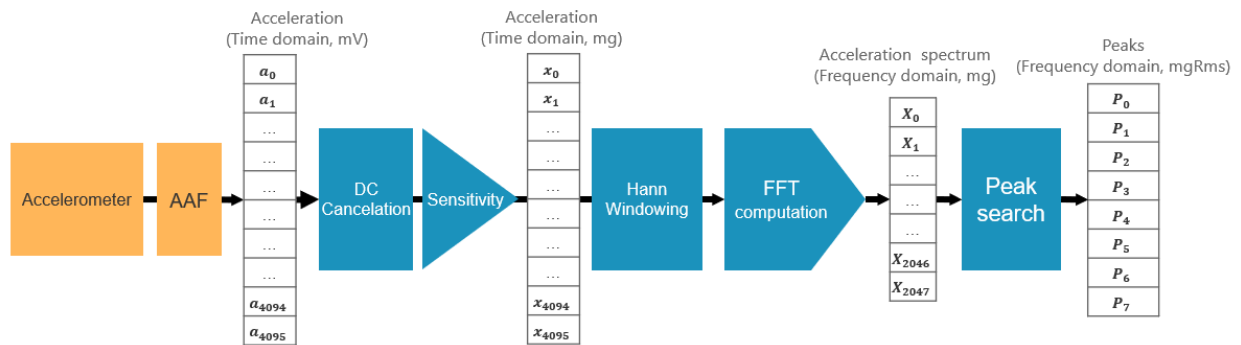

The data processing signal chain transforms the acceleration raw data into frequency peaks.

Acceleration data for each of the three axes is collected at a selected sampling frequency. Raw data passes through an anti-aliasing filter. Once a set of acceleration readings is measured (4096 points), the embedded algorithm removes the DC signal (to remove the bias voltage of the sensing element) and multiplies the results by the sensor element calibration sensitivity (mV/g). The algorithm then applies a Hann window to the signal and converts it into a normalized FFT spectrum. Finally, a peak search algorithm extracts the most significant peaks from the spectrum.

Note that only “Peak values” are accessible by the user. Raw data and raw FFT spectrum are stored for internal computation and are not available outside the sensor.

From this point, several customer defined options are available to further process the data into useful output information (refers to peak search block).

The user can define the FFT resolution mode parameter depending on his application. This gives the maximal observable frequency of the 8931EX. The 16 admissible values cover a range from 200Hz to 20.8kHz. High will be the bandwidth lower will be the resolution.

The 8931EX sensor embeds a peak search algorithm which allows users to find the most significant peaks (in term of magnitude strength) in the frequency domain spectrum.

Every peak will be given over BLE (connected mode) or LoRaWAN (uplink message) with the following information.

Parameters	Description
Peak bin index	Bin index of the peak. Frequency of the peak (Hz) can be calculated by multiplying this value by the FFT resolution.
Peak magnitude RMS	Magnitude of the peak in gRMS integrated on the "bin size"

By default, there is one window, the peak search looks for the most 8 peaks in the full spectrum (from 0 up to 2047 bin) with an integration size of one.

It is possible to program up to 8 custom windows to define several regions of interest and advanced parameters such as number of peaks per window, integration size of the gRMS calculation.

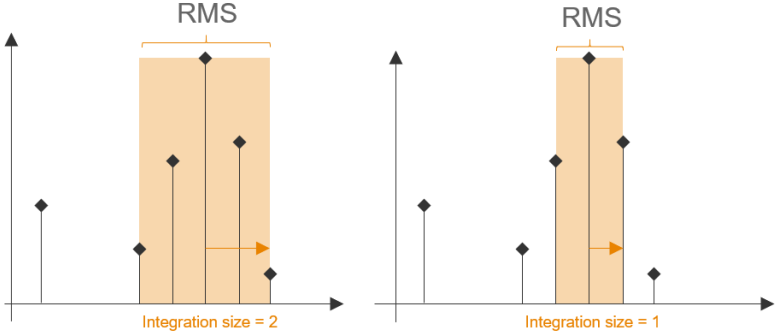
Window configuration	Description
Peak number	Number of peaks to be found (from 0 up to 63) in the particular window
Integration size	<p>Number of bins around the main bin to be integrated into the RMS peak magnitude. This parameter can be used to filter side lobes and avoid multiple peaks found around the same frequency. A value of 1 bin means the central bin plus 1 bin each side of the main bin.</p> 
Min Frequency	Minimum frequency of the search window in bin index
Max Frequency	Maximum frequency of the search window in bin index

Fast Fourier Transform Spectrum

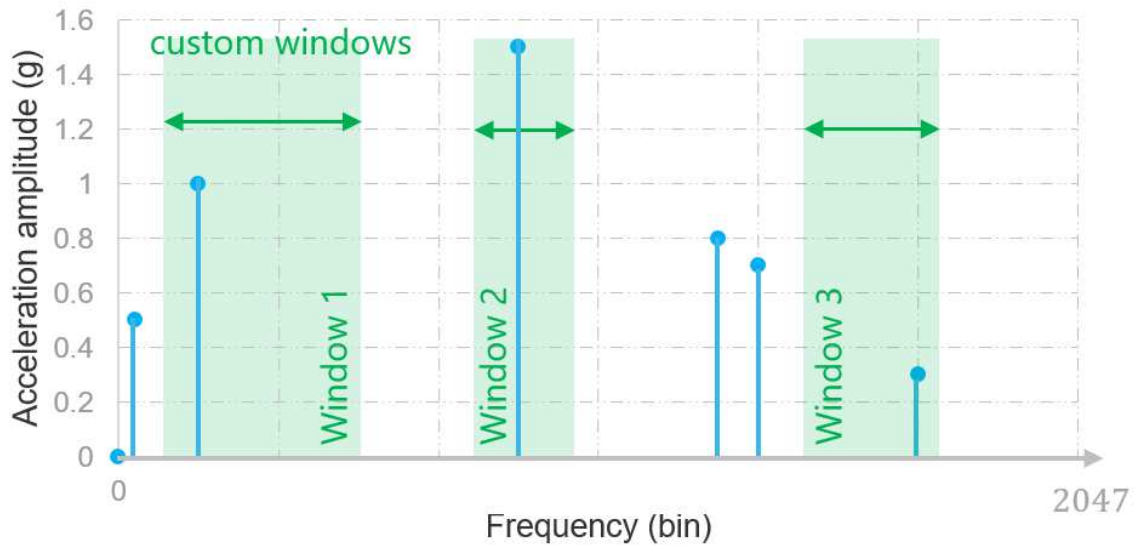

In example below, the sensor Bandwidth mode is set to 10 (12.8kHz, bin resolution is 8Hz). Two custom windows are programmed with the following parameters.

Window index	Parameters
1	Freq: [480 Hz – 3kHz] => [60bin-375bin], Integration size: 5, Nb peak: 1
2	Freq: [4.2 kHz – 11kHz] => [525bin-1375bin], Nb of bins: 3 (150*8=1.2kHz), Nb peak: 2

Legend	Symbol
Frequency min	
Frequency max	▶
Integration size	↔

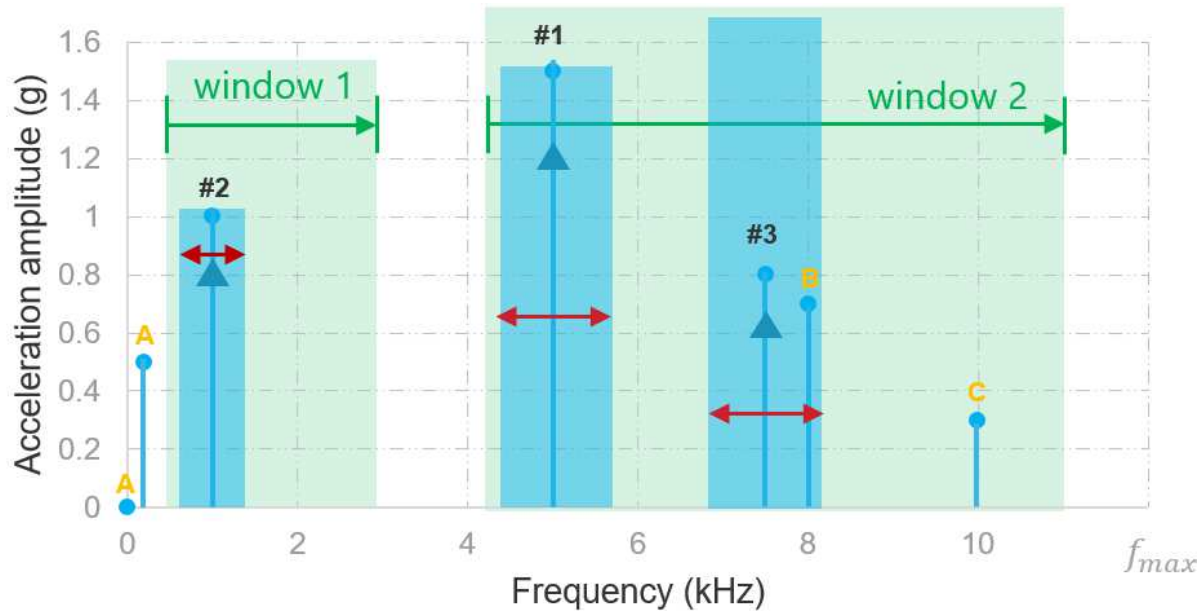

The peak search gives as result: **#1, #2, #3**

Other peaks are filtered out from the search for the following reasons:

- All peaks outside the windows (**A**) will be discarded from the peak search results.
- Any peak (**B**) located in the “integration size” area (number of bin) of a stronger one will be included in the RMS output (of peak #3 in that example) but won’t show up as a detected peak.
- If the number of peaks for a dedicated window is reached, any new other peak (**C**) inside the window will be ignored.

The result of the peak search is given as following:

Legend	Symbol
Peak frequency	┆
Peak magnitude RMS	■

2.5. COMMUNICATION – LoRaWAN™

The device includes a LoRaWAN™ MAC 1.0.3 rev A compliant interface (see LoRaWAN® 1.0.3 Specification). It operates as a Class A end-device. The LoRaWAN™ communication protocol operates in an unlicensed radio spectrum. The part number must be selected to match with the region of operation and be in line with the local regulation.

Region	Frequency	Channel Plan	Common name
Europe (EU)	868 MHz	EU862-870	EU868
United State (US)	915 MHz	US902-928	US915

The LoRaWAN™ upload interval can be configured by the customer for any time between one minute and 24 hours (in one-minute steps).

Data upload consists of this information:

- Battery status
- Sensor internal temperature
- Most significant FFT peak data as configured by the user
- Raw sensor data (time domain accelerometer signal) is not available for upload at any time.

All customer configurable parameters can be adjusted via LoRaWAN™ using a data download:

- Data collection and upload interval
- Number of peaks
- Number of bins around the peaks
- Number of windows
- Window minimum frequency
- Window maximum frequency

Many of the LoRaWAN™ communication features are adaptive and depend on the network quality. The parameters are negotiated and optimized with the connected gateway.

LoRaWAN™ communications are subject to various regulatory bodies around the world and features in the device firmware help maintain compliance.

2.6. BLUETOOTH® LOW ENERGY

The device includes a Bluetooth 5.0 Low Energy compliant interface. This is a low power communication technology which should be used at short distances. It makes the 8931N a connectable beacon which acts as a peripheral by default and switches to a server role (pairing mode) once a remote device (central) is connected. The BLE interface should be used for device configuration only. BLE is activated automatically upon battery insertion. After one hour, the BLE is de-activated to conserve battery energy. BLE can be re-activated by using the magnet switch. After one hour, BLE is de-activated again.

2.6.1. TE SensorConnect App for Mobile Device Communication

The TE SensorConnect Apps can be downloaded from the App Store (iOS) and Google Play (Android). Search for TE SensorConnect App, download and install on your mobile device. The sensor will start the advertising mode when a battery is inserted. The sensor will continue in the advertising mode for one hour after which the BLE radio is turned off to conserve battery energy. The advertising mode can be restarted for a period of one hour by using the magnetic switch.

During the advertising period, basic sensor and status information is transmitted and can be received and read by any other BLE device in close proximity. While advertising, the sensor can enter the connected (or paired) mode and communicate with any mobile device using the BLE App. In the connected mode, various sensor parameters can be configured by the user. Sensor output data can also be viewed.

2.6.2. App screen examples

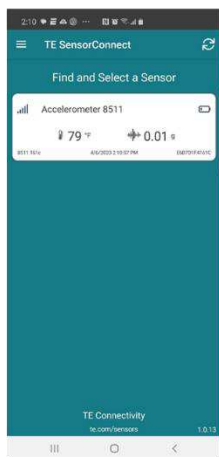

Sensor Dashboard

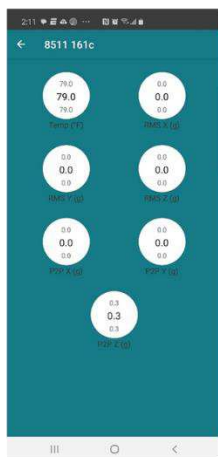

Live Data Mode



Sensor Information

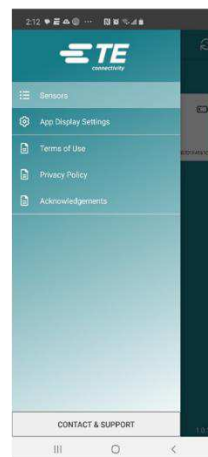

Settings Screen

3. Magnetic Switch

The 8931N has an internal reed switch. This switch is activated when a strong magnet is close to the magnetic sensor location. The magnetic switch location is indicated by the magnet icon on the plastic housing. The magnet must be of sufficient strength and proximity to create a magnetic field of 25 mT at the switch location.

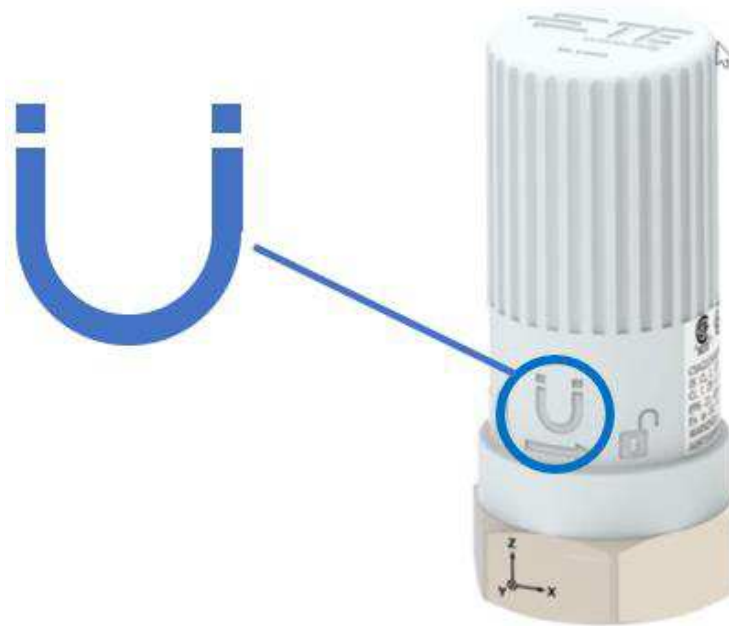

Two different functions are available depending on the user action:

User action	Function	LED
Short tap	Activates BLE for another one hour plus trigs a new measurement and a LoRaWAN™ transmission (uplink if joined, else join request).	One short blink. If user holds the magnet close to the switch for a longer duration, the LED will blink faster. Remove the magnet to only initiate a transmission. Else it going to initiate a sensor reset.
Hold magnet for 10+ seconds	Resets the sensor.	Wait for at least 10 seconds, to see the very fast blink. Release the magnet once a very long orange led appears

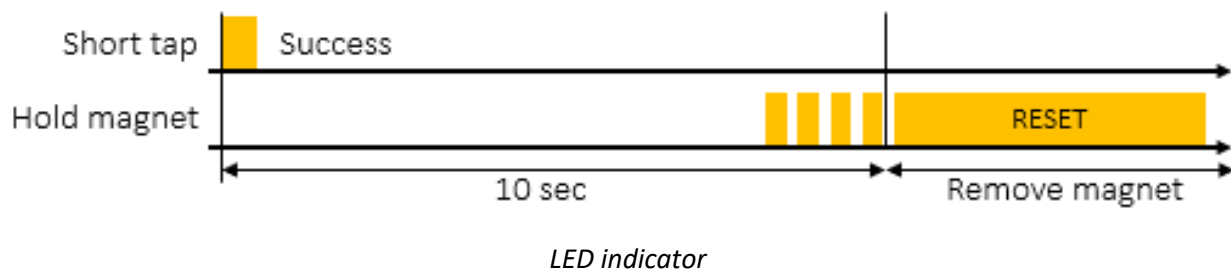

4. LED Indicator

The orange LED indicates the state of the 8931N .

Category	Mode	Description	Pattern
	Power-on/Reset	Led turned on at start up to confirm the battery insertion.	A 2 sec long on
	LoRaWAN™join request	Join request message sent	3 very short blinks
	Uplink	Sending uplink message	very short blink
Status	Success	Operation successful	very short blink
	Fail	Operation failed	1sec long on

The time plots below show the different flash sequences that occur for various actions the sensor is taking.



4.1. LoRaWAN™ Join request examples

A normal join request gives 3 fast blinks (few milliseconds on), a 6 second delay then another short blink. In case of error, the LED is turned on for about 1 second.

Scenario #4: A LoRaWAN™ join request is shown with 3 short blinks (few milliseconds on) and about a 6 second later, another short blink (join accept from the gateway).

Scenario #5: For EU-868 region, if an error pattern (1 sec on) is shown just after the 3 blinks, it means the device hasn't sent the message due to duty cycle restrictions.

Scenario #6: In case no response from the gateway, and after about 6 sec after the 3 short blinks, the LED is turned on for about 1 second.

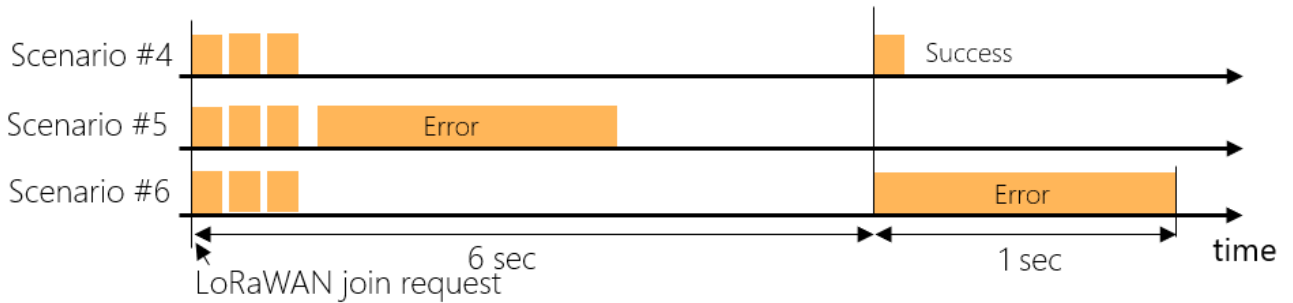

4.2. LoRaWAN™ Uplink transmission Examples

Scenario #1: A normal uplink transmission gives 1 short blink (few milliseconds on) and few seconds later, another short blink (ack from the gateway).

Scenario #2: For EU-868 region, if an error pattern (1 sec on) is shown just after a short blink, it means the device hasn't sent the message due to duty cycle restrictions.

Scenario #3: In case no response from the gateway (Confirmed message up needs a downlink with an acknowledge), delay is about 2 sec after the short blink, the LED is turned on for about 1 second (nack).

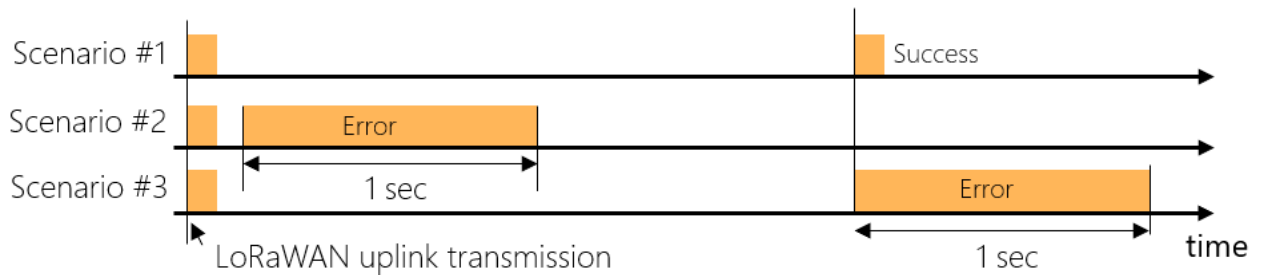



5. Presets

The 8931N has several adjustable functions that tailor the output data to meet user needs. To easily manage these functions, the 8931N has a feature called “Preset”. This feature allows the user to combine functions into commonly used or unique preset configurations.

The presets are divided in two different categories:

- **User:** editable area which allows the user to create his own configurations.
- **Factory predefined:** read only preset which are callable for an easy and fast configuration

By default, the 8931N uses the “User preset 0”. Any change to the sensor settings such as Bandwidth, Measurement interval, Windows count... will affect the “user preset 0” only. The table below shows the various preset configurations. There are 16 user adjustable configurations (ID 0 – 15) and 15 factory predefined configurations (ID 64 – 78).

Category	Preset		DSP		Peak search windows					
	NAME	ID	BW_MODE (Hz)	MEAS_INTERVAL	ID	ENABLE	Boundaries		INTEG_SIZE	PEAK_NB
							MIN (Hz)	MAX (Hz)		
 User	USR_PR_0	0	9 (11.2k)	1 hour	0	True	0 (0)	1599 (11.2k)	1	8
					1	False	-	-	-	-
					2	False	-	-	-	-
					3	False	-	-	-	-
					4	False	-	-	-	-
					5	False	-	-	-	-
					6	False	-	-	-	-
					7	False	-	-	-	-
	USR_PR_1	1	9	1 hour	0	True	0	1599 (11.2k)	1	8
	USR_PR_n	n
	USR_PR_15	15	9	1 hour	0				1	8
 Factory Predefined	8931_Default	64	11 (14.4k)	1 hour	0	True	0 (0)	1599 (14.4k)	1	8
	BW1K6_ULP	65	3 (1.6k)	1 day	0	True	0 (0)	1599 (1.6k)	1	8
	BW4K8_ULP	66	5 (4.8k)	1 day	0	True	0 (0)	1599 (4.8k)	1	8
	BW9K6_ULP	67	8 (9.6k)	1 day	0	True	0 (0)	1599 (9.6k)	1	8
	BW1K6_LP	68	3 (1.6k)	0.5 day	0	True	0 (0)	1599 (1.6k)	1	8
	BW4K8_LP	69	5 (4.8k)	0.5 day	0	True	0 (0)	1599 (4.8k)	1	8
	BW9K6_LP	70	8 (9.6k)	0.5 day	0	True	0 (0)	1599 (9.6k)	1	8
	BW1K6_STD	71	3 (1.6k)	1 hour	0	True	0 (0)	1599 (1.6k)	1	8
	BW4K8_STD	72	5 (4.8k)	1 hour	0	True	0 (0)	1599 (4.8k)	1	8
	BW9K6_STD	73	8 (9.6k)	1 hour	0	True	0 (0)	1599 (9.6k)	1	8
	BW1K6_HR	74	3 (1.6k)	15 min	0	True	0 (0)	1599 (1.6k)	1	8
	BW4K8_HR	75	5 (4.8k)	15 min	0	True	0 (0)	1599 (4.8k)	1	8
	BW9K6_HR	76	8 (9.6k)	15 min	0	True	0 (0)	1599 (9.6k)	1	8
	BW9K6_RTH	77	8 (9.6k)	15 min	0	True	266 (1.6k)	1599 (9.6k)	1	8
	BW1K6_RTL	78	3 (1.6k)	45 min	0	True	0 (0)	1599 (1.6k)	4	8

5.1. MANAGING PRESETS

By default, the sensor uses the “User Preset 0”. It is possible to switch between 2 presets by writing the preset identifier to be loaded in a specific register. It can be done anytime.

Once the preset loaded, the parameters shown in the previous table are applied and are instantaneously effective.

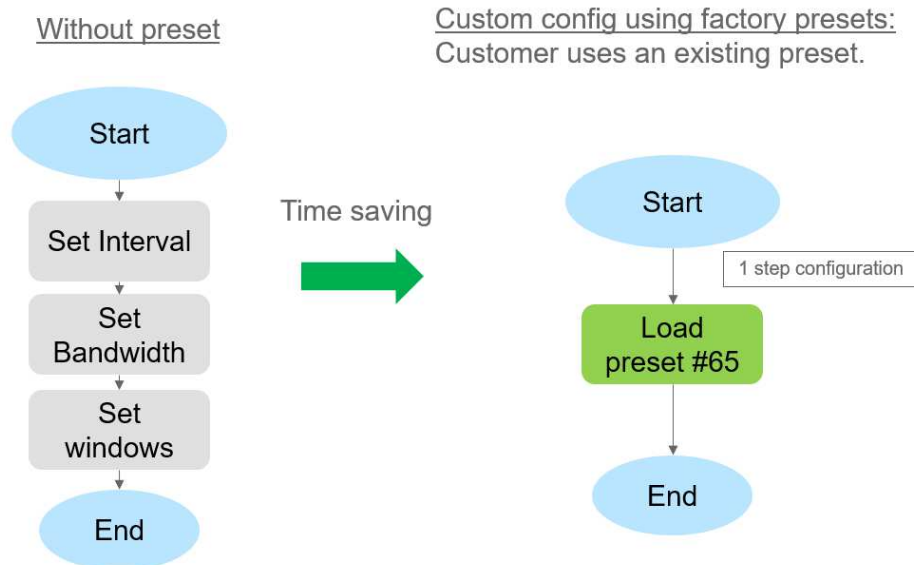

If the selected preset is a user preset, the parameters of the active preset can be modified (and saved) in the usual way (over BLE or LoRaWAN™) using the default commands.

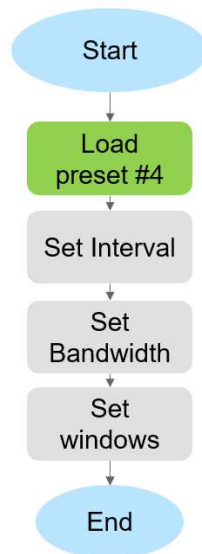

5.2. ROTATING PRESET MODE

In addition to the presets, the 8931N implements a feature called “Rotating mode”. This provides the user a way to alternate between two presets continuously. After the execution of a preset, the second preset queued in the mode will be loaded, then once executed it comes back to the first.

The example below shows how to take advantage of the rotating mode. Here 2 presets are configured with 2 different bandwidth and measurement interval.

The self-Rotating mode automatically switches between #0 and #1 without any external user action required.

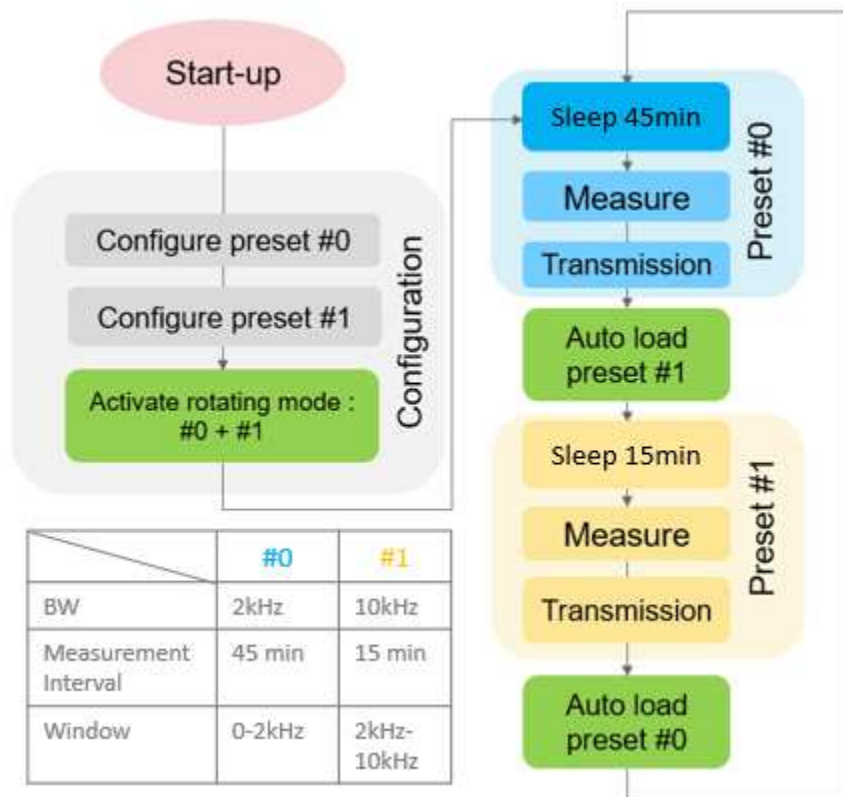

With the example, every 1 hour will result of having 2 measurements: one with a high frequency band and another (15min later) with a low bandwidth but with a higher resolution.

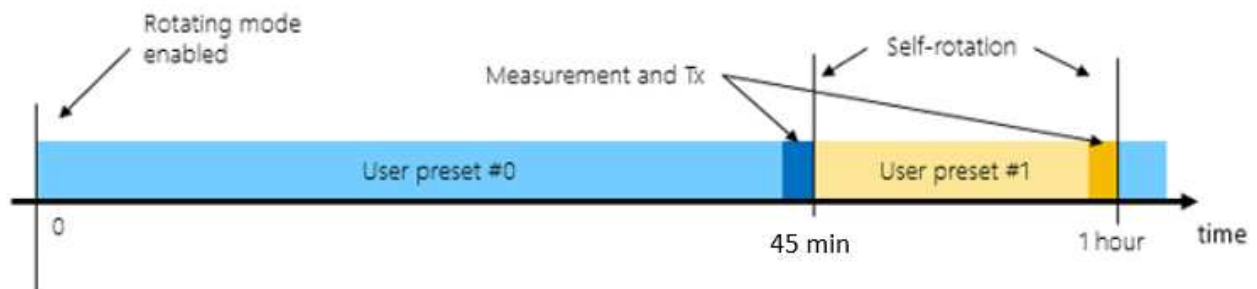

6. Battery

6.1. BATTERY TYPE

To meet various certification requirements, the following battery must be used:

Parameters	Typical value
Manufacturer	SAFT
Reference	LS 17330
Technology	Primary lithium-thionyl chloride (Li-SOCl ₂)
Nominal voltage	3.6 V
Capacity at 20°C	2100 mA

6.2. BATTERY LIFE

The 8931N vibration sensor is designed to use battery power in the most efficient ways possible. However, battery quality, long term ambient temperature conditions, data collection and transmission intervals, and spreading factor will impact overall battery life.

- **Battery Quality** – Batteries for the sensor must be acquired from authorized distributors and sources. This ensures that batteries have been stored and transported in temperature conditions that do not exceed the manufacturer’s recommended limits. End users must also store batteries within these temperature limits. If batteries are exposed to temperatures exceeding recommended limits, battery life will be affected.
- **Ambient Temperature Conditions** – Optimum battery life can be expected when the ambient temperature is near 25°C. In most applications, the temperature will vary within the specified limits. These variations can shorten battery life.
- **Data Collection and Transmission Intervals** – The sensor consumes the most power when it is taking measurements, processing the data, and transmitting the information via radios. The user can select the intervals for these actions. Longer intervals will consume less battery power and result in longer battery life.
- **Spreading Factor** – This impacts communication performance of the LoRaWAN™ radio. A larger spreading factor increases the time on air, increases receiver sensitivity, reduces data rate, all to improve communication range. Higher spreading factors will consume more battery energy shortening battery life.
- Under the most ideal conditions, a battery life of 4 years is expected. However, each application will have conditions that are something less than ideal. These typical applications should expect a battery life between 3 and 4 years.

6.3. BATTERY REPLACEMENT

The 8931N's battery must be replaced if depleted. Unscrew the plastic housing and remove it from the base. Carefully pull on the orange tab to remove the battery. Note that it **MUST** be replaced by the same battery type as shown above. Substitute batteries may damage and/or bring uncontrolled behavior to the sensor. Double check the polarity and then insert the new battery inside the holder. Re-attach the plastic cover on the sensor. Refer to the Installation Manual (Doc# 20023687-24) for specific details regarding battery installation and replacement. When complete, the battery life estimator in the firmware must be reset to a "full" battery status.

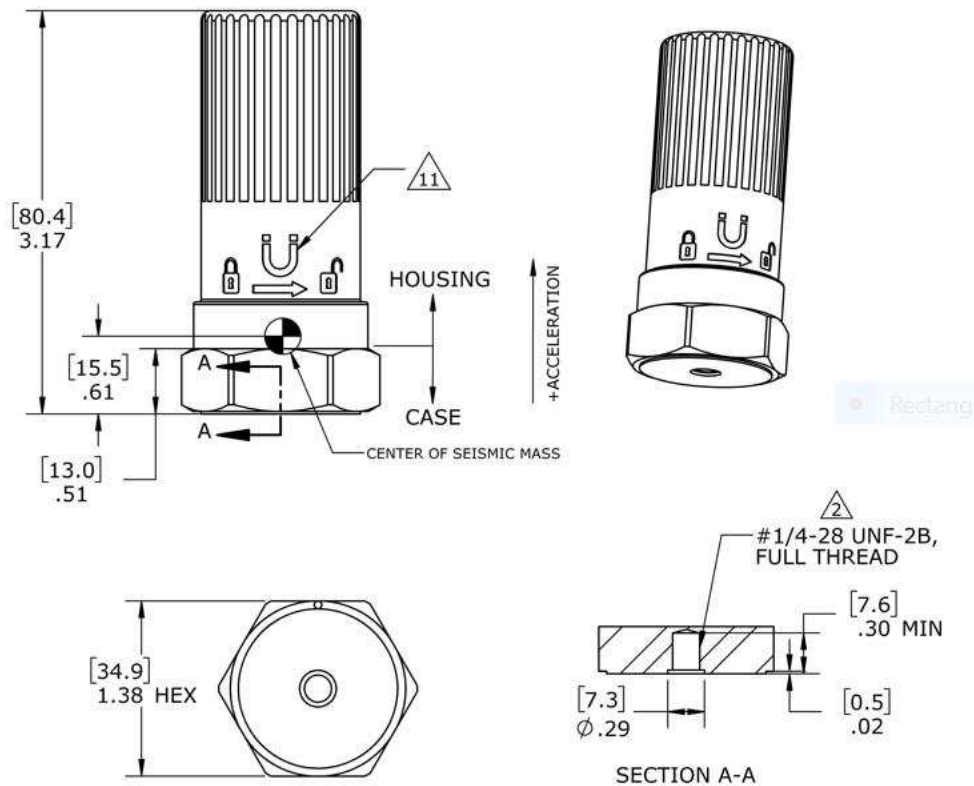

7. Dimensions

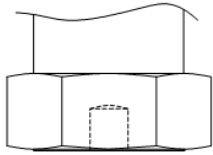
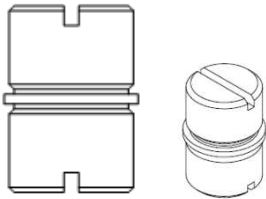
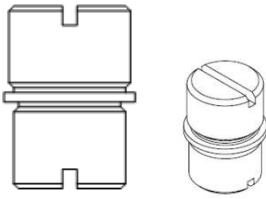
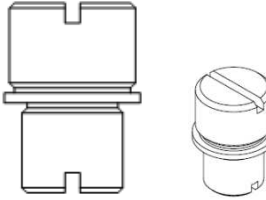

8. Mounting Considerations & Accessories

A solid mounting method is required to get optimum performance from the accelerometer. Any loose parts or unsecured mounting features will introduce noise and corrupt the signals of interest. Shown below are seven different mounting options available for the 8931N accelerometer.

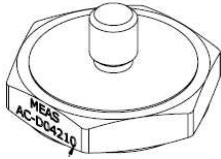
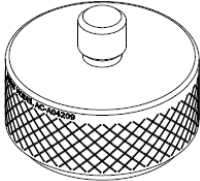
Part Number	Description	Image	Notes
None	1/4 -28 Female Threaded Hole		<ul style="list-style-type: none"> Integral part of the basic sensor Mates to existing 1/4-28 male stud or to any mounting accessory from TE
AC-D03636	1/4-28:1/4-28 Male Stud		<ul style="list-style-type: none"> Torque to values shown in the Installation Manual Doc# 20023687-24
AC-D03665	1/4-28:M6x1.0-6g Male Stud		<ul style="list-style-type: none"> Torque to values shown in the Installation Manual Doc# 20023687-24
AC-D03664	1/4-28:M5x0.8-6g Male Stud		<ul style="list-style-type: none"> Torque to values shown in the Installation Manual Doc# 20023687-24

Part Number	Description	Image	Notes
AC-D04210	1/4-28 Male Adhesive Mount		<ul style="list-style-type: none"> • Mount with a rigid adhesive such as epoxy or cyanoacrylate • Remove oil, grease, and debris from the mounting surface prior to attachment
AC-A04209	1/4-28 Male Magnetic Mount		<ul style="list-style-type: none"> • Remove magnet “keeper” from the bottom mounting surface before installation • 30 lbf (133.5N) required for removal from a ferrous mounting surface
20027468-00	1/4-28 Male Rotating Mount		<ul style="list-style-type: none"> • Allows sensor to be physically aligned to the desired X and Y axes

For the adhesive mounting stud, secure with a rigid adhesive such as epoxy or cyanoacrylate. Do not use pressure sensitive adhesives or foam tapes. For the magnetic mounting stud, remove the keeper prior to attachment. The magnetic mounting will have a 30 lb pull strength when attached to a ferrous surface.

Note – Some mounting accessories may be supplied as part of a kit. For large volume deliveries, desired mounting accessories must be ordered as a separate item or procured independently.

9. Regulatory Statements

FCC and IC

This Radio Equipment is Certified for FCC (US) and ISED (Canada).

This equipment does not support simultaneous transmissions.

Changes or modifications not expressly approved or authorized by TE Connectivity for compliance could void the user's authority to operate the equipment.

FCC Warning:

THIS DEVICE COMPLIES WITH PART 15 OF THE FCC RULES. OPERATION IS SUBJECT TO THE FOLLOWING TWO CONDITIONS: (1) THIS DEVICE MAY NOT CAUSE HARMFUL INTERFERENCE, AND (2) THIS DEVICE MUST ACCEPT ANY INTERFERENCE RECEIVED, INCLUDING INTERFERENCE THAT MAY CAUSE UNDESIRE OPERATION.

Note: This equipment has been tested and found to comply with the limits for a Class B digital device, pursuant to Part 15 of the FCC Rules. These limits are designed to provide reasonable protection against harmful interference in a residential installation. This equipment generates, uses, and can radiate radio frequency energy and, if not installed and used in accordance with the instructions, may cause harmful interference to radio communications. However, there is no guarantee that interference will not occur in a particular installation. If this equipment does not cause harmful interference to radio or television reception, which can be determined by turning the equipment off and on, the user is encouraged to correct the interference by one or more of the following measures:

- Re-orient or relocate the receiving antenna
- Increase the separation between the equipment and the receiver
- Connect the equipment to an outlet on a circuit that is different from that to which the receiver is connected.
- Consult the dealer or an experienced radio/TV technician for help.

Industry Canada (IC) Warning:

This device complies with ISED Canada license-exempt RSS standard(s). Operation is subject to the following two conditions: (1) this device may not cause interference, and (2) this device must accept any interference, including interference that may cause undesired operation of the device.

Le présent appareil est conforme aux CNR d'ISED Canada applicables aux appareils radio exempts de licence. L'exploitation est autorisée aux deux conditions suivantes : (1) l'appareil ne doit pas produire de brouillage, et (2) l'appareil doit accepter tout brouillage radioélectrique subi, même si le brouillage est susceptible d'en compromettre le fonctionnement.

Radiation Exposure Statement - This equipment should be installed and operated with minimum distance 20cm between the radiator & your body.

Déclaration d'exposition aux radiations - Cet équipement est conforme Canada limites d'exposition aux radiations dans un environnement non contrôlé. Cet équipement doit être installé et utilisé à distance minimum de 20cm entre le radiateur et votre corps.

EU CONFORMITY

Hereby, Measurement Specialties (China), Ltd. a TE Connectivity Company, declares that this Wireless Vibration Sensor is in compliance with essential requirements and other relevant provisions of the following directives:

Directive 2014/53/EU
Directive 2014/30/EU
Directive 2014/35/EU

Model Families: 8911N & 8931N

Max Output Power for E.U.

Unit Configuration, BLE: +1.654dBm (-2.476 dBm EIRP)

Data Communication, LoRa: +5.252dBm (+7.402 EIRP)

Manufacture/Brand: TE Connectivity Ltd

Manufacturer:

Measurement Specialties (China) LTD
No 26 LangShan Road
518057 Shenzhen-Nanshan District, China

European contact:

TE Connectivity Sensors France
4 Rue Gaye Marie
31027 Toulouse – France

Please contact customer service for inquire about official regulatory documentation.

10. Intrinsic Safety Models

This Equipment is certified for Intrinsic Safety when model code “EX” is selected during the ordering process. Please see ordering information in Section 11 for details:

Intrinsic Safety approval is as follows:

IS Class I, Div1, Groups A, B, C, and D;
Class I Zone 0, AEx ia IIC T4 Ga;
Ex ia IIC T4 Ga;
II 1 G Ex ia IIC T4 Ga

11. Ordering Information

The 8931N is packaged in kits that contain mounting accessories and a battery insertion tool. Use the TCPN number when ordering to ensure that you receive the proper kit.

Order TCPN	Sensor Model Number	Accessories Included							
		¼-28:¼-28 Male stud	¼-28:M5 Male stud	¼-28:M6 Male stud	Magnetic Mount	Rotation Mount	Adhesive Mount	Battery (Saft 17330)	Battery Insert Tool
20023689-20	8931N-NX-A Not Ex certified 915MHz LoRa for US	•	•	•	•	•			•
20023689-30	8931N-NX-E Not Ex certified 868MHz LoRa for EU	•	•	•	•	•			•
20023689-80	8931N-NX-A Not Ex certified 915MHz LoRa for US	•						•	•
20023689-90	8931N-NX-E Not Ex certified 868MHz LoRa for EU	•						•	•
20025129-20	8931N-EX-A Ex certified 915MHz LoRa for US	•	•	•	•	•			•
20025129-30	8931N-EX-E Ex certified 868MHz LoRa for EU	•	•	•	•	•			•
20025129-80	8931N-EX-A Ex certified 915MHz LoRa for US	•						•	•
20025129-90	8931N-EX-E Ex certified 868MHz LoRa for EU	•						•	•

8931N WIRELESS ACCELEROMETER

Note: Ex certified products conform to these standards:

Explosive Atmospheres: ATEX/IECEX/US/CANADA IS CL I, DIV 1, GRP A, B, C, D, T4;
CL 1. ZN 0, AEx ia IIC T4 Ga; II 1 G, Ex ia IIC T4 Ga;

To order accessories separately, use these TCPN numbers:

Order TCPN	Accessory Description
20027468-00	¼-28:¼-28 Rotating Mount
AC-D04210	Adhesive Mounting Adaptor
AC-A04209	Magnetic Mounting Adaptor
AC-D03636	¼ x 28 by ¼ x 28 Double-ended Male Stud
AC-D03665	¼ x 28 by M6 Double-ended Male Stud
AD-D03664	¼ x 28 by M5 Double-ended Male Stud

12. Additional Notes:

Sales and technical support

NORTH AMERICA

Measurement Specialties, Inc.,
a TE Connectivity Company
Phone: +1 800-745-8008
Email: TEsensors-CCMeas@te.com

EUROPE

Measurement Specialties (Europe), Ltd.,
a TE Connectivity Company
Phone: +31 73 624 6999
Email: customercare.lcsb@te.com

ASIA

Measurement Specialties (China), Ltd.,
a TE Connectivity Company
Phone: +86 0400-820-6015
Email: customercare.shzn@te.com

Manufacturer: Measurement Specialties (China) Inc., a TE Connectivity Company
No. 26 Langshan Road, Shenzhen High-Tech Park (North), Nanshan District, Shenzhen, 518057
Tel: +86 0400-820-6015 customercare.shzn@te.com

te.com/sensors

The Bluetooth® word mark and logos are registered trademarks owned by the Bluetooth SIG, Inc. and any use of such marks by TE Connectivity is under license. Other trademarks and trade names are those of their respective owners.

Measurement Specialties Inc., a TE Connectivity company.

Measurement Specialties (MEAS), American Sensor Technologies (AST), TE Connectivity, TE Connectivity (logo) and EVERY CONNECTION COUNTS are trademarks. All other logos, products and/or company names referred to herein might be trademarks of their respective owners.

The information given herein, including drawings, illustrations and schematics which are intended for illustration purposes only, is believed to be reliable. However, TE Connectivity makes

no warranties as to its accuracy or completeness and disclaims any liability in connection with its use. TE Connectivity's obligations shall only be as set forth in TE Connectivity's Standard

Terms and Conditions of Sale for this product and in no case will TE Connectivity be liable for any incidental, indirect or consequential damages arising out of the sale, resale, use or misuse

of the product. Users of TE Connectivity products should make their own evaluation to determine the suitability of each such product for the specific application.

© 2022 TE Connectivity Ltd. family of companies All Rights Reserved.